

## **4. CLARIFICATION, RED MUD WASHING, AND LIQUOR FILTRATION**

The papers in this section have been selected as a cross section of design and industry practice for liquor clarification and red mud washing facilities. Discussions of the fundamental research in how mud, liquor, and flocculent characteristics impact the performance of these facilities are included.

The alumina refinery process transformed from a batch operation to a nearly continuous process during World War II. Multiple trains of large diameter mud washers were required in continuous operation to recover caustic and alumina values from the liquor associated with thickener mud slurry and to provide an environmentally suitable red mud for disposal. The advent of modern flocculating agents and the subsequent technological development of modern thickeners reduced the thickeners to a fraction of their former size and significantly improved mud underflow solids content. This reduced the number and size of washing stages required. The overall breakthrough in the technology was momentous.

Liquor filtration developed from manually operated and sluiced Kelly Filters to automated self sluicing filters. This has changed liquor filtration from onerous and largely unsafe to an acceptable and safe operation. Sand classification prior to the washer circuit has progressed from crude mechanical rake or spiral type classifiers to hydrocyclone circuits.

The improvements in clarification, red mud washing, and liquor filtration have made modern refineries safer to operate and have significantly lowered capital, operating, and maintenance costs.

*Tim Laros*

## SELECTION OF SEDIMENTATION EQUIPMENT FOR THE BAYER PROCESS AN OVERVIEW OF PAST AND PRESENT TECHNOLOGY

TMS<sup>1</sup>, Tim J. Laros & Frank A Baczek<sup>2</sup>

<sup>1</sup>TMS (The Minerals, Metals & Materials Society); 184 Thorn Hill Rd.; Warrendale, PA 15086, USA

<sup>2</sup>FLSmith Minerals, Salt Lake City, Utah, USA

Keywords: Thickeners, Red Mud Washers, Deep Cone Thickeners

### Abstract

The Bayer Process relies heavily on sedimentation Equipment in Desilication, Liquor Clarification, Residue Disposal, Tertiary Seed Classification, as well as Caustization and Oxalate Removal.

Over the past 20 years, sedimentation equipment design and operating philosophies have changed dramatically with the advent of feed slurry dilution, new flocculants, and robotic descaling.

This paper will present an overview of the progression of Bayer Process sedimentation technology and current equipment options available.

### Introduction

The Bayer Process includes approximately 10 solid/liquid separation steps, 4 or 5 of which involve sedimentation. The major sedimentation duty in a typical refinery is liquor clarification and residue washing and disposal.

The red mud handling circuit usually consists of settlers for liquor clarification followed by 5 to 10 stages of washing thickeners or washers using counter current decantation (CCD) to remove and recover caustic soda from the mud prior to disposal. In some circuits, the last washing stages are replaced with rotary vacuum drum filters, however this is less common particularly with large mud loads and paste residue disposal schemes.

### Evolution of the Red Mud Clarification Circuit

This mud clarification and washing circuit has evolved over the years, starting with blow down filtration using Kelly Filters. Figure 1 depicts this type of clarification circuit. The last blowdown refinery was converted to CCD in 2003. Next was mud washing with balanced tray thickeners, in which 4 or 5 stages of washing was done in one tank. Figures 2 & 3 show a multi deck tray thickener and the inner mixing chamber. At least one refinery commissioned in the early 1950's is still using tray thickeners for mud washing. This was followed by large diameter conventional washers using starch for flocculation, and finally Deep Cone Thickeners (DCT) and High Rate Thickeners (HRT) both using feed slurry dilution and synthetic flocculants.

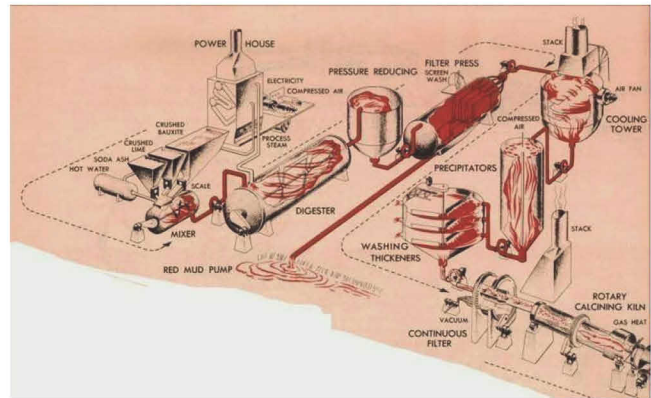

Figure 1. Mud Clarification Circuit with Kelly Filters.

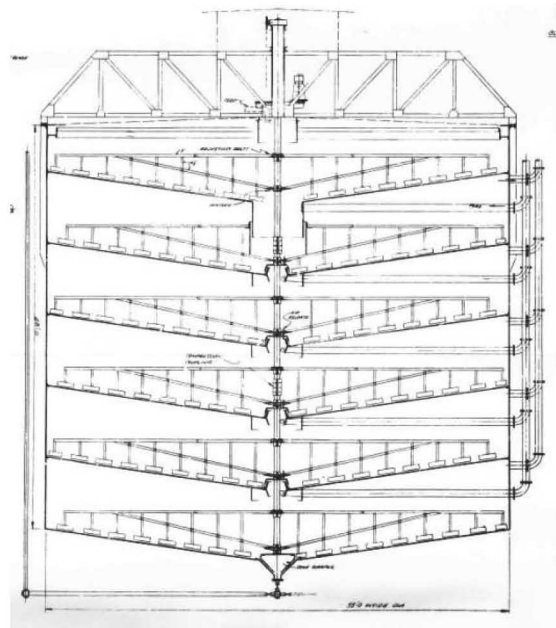

Figure 2. Washing Type Tray Thickener

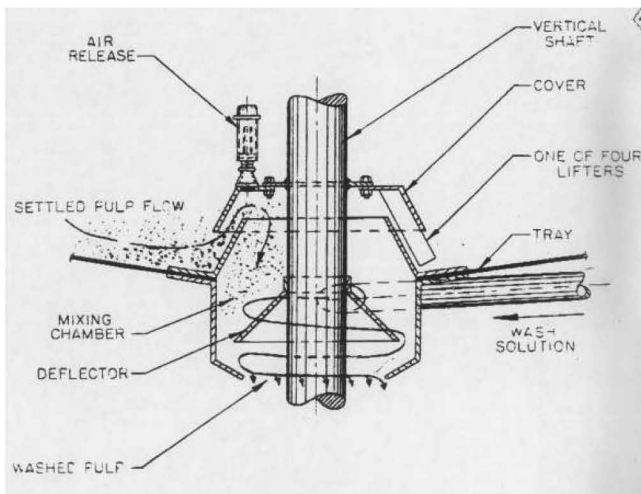

Figure 3. Seal for Washing Tray Thickener.

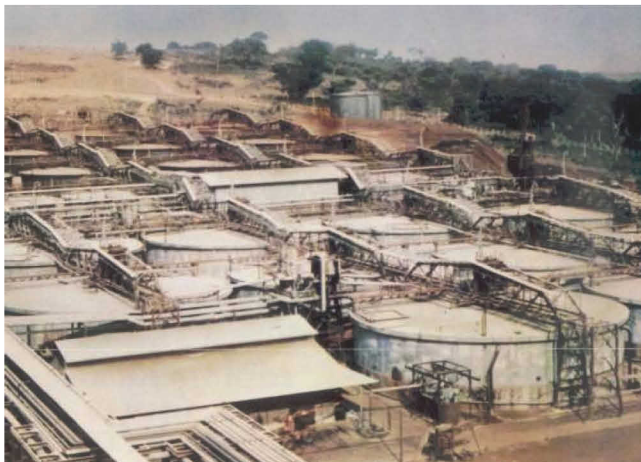

Figure 4. Washer Trains circa 1960 - 1 Unit Refinery

The conventional settlers and washers used either flat bottom tanks with outward raking mechanisms and peripheral discharge or elevated cone-bottom tanks with inward raking central discharge. Both rake mechanisms were quite often Cable Torque® or Swing Lift® depending on manufacture by Dorr-Oliver or Eimco Process Equipment. A myriad of other mechanisms were also used such as Thixo® Posts, chains instead of blades, etc, with one goal in mind: reduce the steel in the mud, as it was felt this would reduce the amount of scale formation on the rakes.

Flat bottom tanks with outward raking mechanisms saved capital cost and were easier to de-scale. From a process standpoint, without sophisticated underflow control or pumping systems, this type of washer produced an inconsistent underflow slurry concentration as a function of rake position, and lower underflow slurry concentrations than conical bottom washers. Consequently, the flat bottom tank with cable supported rake design is seldom used today. Many refineries have studies underway to evaluate replacing this type of equipment.

Basic washer sizing rules of thumb for the 1950's are summarized as follows:

- 1950-1990
  - Settlers 1.8-2.3 m<sup>2</sup>/MTPD (20 -25 ft<sup>2</sup>/TPD)
    - Causticized Starch
    - 100-200 ppm Overflow Clarity
  - Washers 0.9-1.1 m<sup>2</sup>/MTPD (10-12 ft<sup>2</sup>/TPD)
    - Flocculant
    - No Feed Slurry Dilution
    - 350-400gpl Underflow Concentration

A 1 million TPA refinery of the 1950-1990's might have 6 – 35 meter diameter settlers followed by 2 to 4 trains of 6 to 7- 35 meter diameter washers. This was great business for the thickener suppliers but a large capital and operating cost. The throughput of the 1960's vintage mud clarification circuit can now be accomplished with 1 or 2 trains of much smaller diameter Deep Cone® Thickeners (DCT) or High Rate settlers and washers. This increase in performance and corresponding decrease in size and number is due to better synthetic flocculants and better utilization of these flocculants by optimizing feed slurry concentration for improved flocculation with self-diluting feedwells as well as optimizing other feedwell design parameters. Today's sizing parameters are summarized as:

- Current Sizing Rules of Thumb
  - Settlers 0.5 m<sup>2</sup>/MTPD
    - Hx Type Flocculants
    - 50 ppm Overflow Clarity
  - Washers 0.25 m<sup>2</sup>/MTPD
    - Feed Slurry Dilution
    - >500 gpl Underflow Concentration

#### Current Design Considerations

The modern mud clarification and washing circuit now looks like Figure 6. Gone are the large flat bottom tanks, as well as the associated pumps and piping; replaced by small diameter tall conical bottom tanks which can process 4 to 5 times the quantity of mud over that of an old washer circuit.



Figure 6. Alcan Deep Cone® Thickeners at RioTinto Gove Refinery.

Not only has the size and height of the settlers and washers changed, so have the internal raking mechanism designs. In the past, the general philosophy was that the mechanism had to lift as the torque increased to some limiting value. The lift was either mechanical, i.e. a screw jack that lifted the rake independent of the drive, or a platform that lifted the entire drive and rake together at a preset torque value, or automatically through a cable support and towing arrangement, or sometimes both. The cable lift was known as the Cable Torque® or Swing Lift® shown in Figure 7.

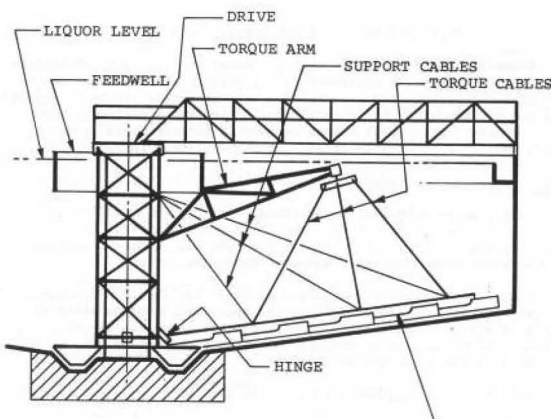

Figure 7. Cable Supported Type Rake Arm.

These types of rakes have a special hinged connection to the center shaft. The ballasted arm lifts upward at the hinge if resistance is experienced by the rake from the mud bed, causing the rake to move out of the mud and the torque to be reduced. The design supposedly minimized the quantity of steel in the thickener as the rake was supported and towed by cables rather than the structural members of the rake. In actuality, scale forms on the cables and between the cables and the rake arm, thus scale formation is promoted rather than reduced. The hinge also scales up rendering the lift mechanism un-operable. Nice theory, not great practice.

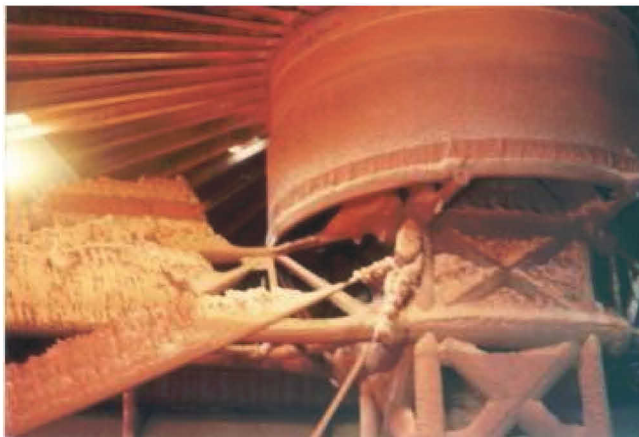

Figure 8. Scale Formation on Cable Supported Washer Rakes.

Current design philosophy is to provide a drive head and rake mechanism with excess torque capability such that a lift is not needed.

The rake designs have also been improved to minimize the quantity of steel in the mud and liquor to reduce the surface area available for scale formation. Simple-member rake arms rather than box truss or Thixo ® post type arms are used. In some cases, chains rather than rake blades are used in the first stage washers. In the last stage washers, pickets are added to the rakes to enhance washer performance.

Settler and washer feedwell design has changed to incorporate feed slurry dilution. Even in the settlers where the feed slurry is rather dilute, additional dilution is beneficial. The E-Duc Feedwell dilution system has been employed on Deep Cone® Thickeners and High Rate Thickeners very successfully. A typical High Rate Thickener is depicted in Figure 9.

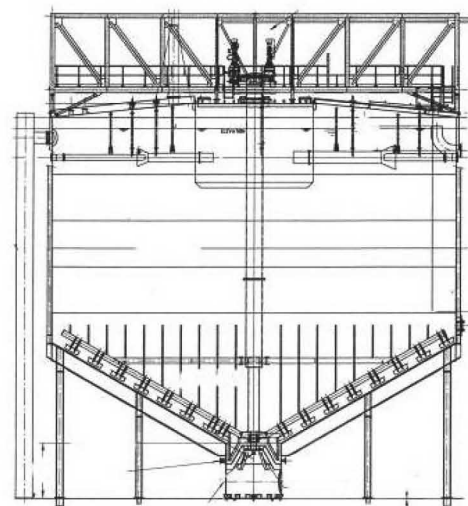

Figure 9. Typical High Rate Thickener

The modern mud clarification and washing circuit now consists of fewer, smaller diameter, taller units with feed slurry dilution and simple rake arms connected to high torque drive heads without a rake lifting mechanism.

These basic design parameters are also used in mud residue disposal thickeners. The drive head torque capability is usually increased and rake design often changed such that paste type underflow slurry is produced for dry stacking. With Rio Tinto ALCAN licensed type DCT thickeners, the underflow slurry, which has a very high yield stress due to the increased underflow solids concentration, is often recycled back into the underflow discharge cylinder for shear-thinning to improve the pumping characteristics for mud transfer. With the patented shear-thinning system, ALCAN type DCTs are able to produce and manage a higher underflow slurry concentration than can be produced in a High Rate type thickener

The use of smaller diameter taller settlers, washers and residue disposal thickeners with steeply sloped conical floors has posed a new challenge to descaling. Robotic descaling mechanisms or arms have been developed to safely descale these tanks. [1] Consideration must be made in the tank design and layout of the

mud clarification and washing area to allow access for the installation and removal of these arms in the tanks as well as the support and operation of the arms in the tanks.

In other areas of the refinery, these design parameters are also being applied for sedimentation duties such as sodium oxalate and recaustization thickeners. The exception to this is Tertiary or Fine Seed Thickening. In many refineries, tray thickeners are used to thicken fine seed. Tertiary seed thickening is actually a clarification duty rather than a thickening duty. A 4 or 5 compartment tray thickener actually provides 3 to 4 times the clarification area in a single tank. In this application, the tray thickener acts as 4 clarifiers stacked on one another with the flow split to the trays. Capital and operating costs are hence reduced and heat is conserved. Descaling is usually done chemically rather than mechanically, hence access to each compartment for mechanical descaling is not a problem.

### Summary

The mud clarification and washing circuit of alumina refineries has changed considerably in the past 50 years, starting from a batch filtration process and evolving to a CCD process with many trains of large diameter washers having various geometries and rake designs.

The modern mud clarification and washing circuits developed in the past 15 years now consists of fewer, smaller diameter, taller washers with feed slurry dilution and simple rake arms connected to high torque drive heads without a rake lifting mechanism which produce higher underflow slurry concentrations at higher solids loadings.

### References

1. C. Potvin et al., "Customized De-Scaling Robots-Improving Workers' Health and Safety, Increasing Alumina Production Capacity" TMS Light Metals pp 69-70, (2008).