

THE GENERATION OF FINES DUE TO HEATING OF ALUMINA TRIHYDRATE

J.D. Zwicker

Alcan International Limited
Kingston Laboratories
P.O. Box 8400
Kingston, Ontario
Canada
K7L 4Z4

Abstract

The increase in fines during the calcination of trihydrate, especially in fast fluid beds, is of concern to both producer and user. To identify the factors in calcination which influence fragility, laboratory studies have been carried out covering static to flash heating. Questions such as explosive generation of fines, particle shrinkage, and effect of rate of heating were examined. Most work was done using powders but some single particle studies were carried out.

Introduction

The fines content, normally measured as the amount of minus 45 μ m (325 mesh), plays a role in dustiness and flowability. Some of these fines are due to calcination itself and as such the process merits examination. This paper addresses the question of the effect of heat on fragility and the subsequent generation of fines. Definition of terms and tests methods will be found in Appendix A.

The Effect of Heating on Particles

When alumina trihydrate is heated water is driven off, and as calcination progresses the density falls and then increases slowly. Cracks appear in the particles. How these physical changes result in fines generation and fragility is unclear. One concept is that at elevated temperatures the internal steam pressure may rupture it thereby creating fines.

Explosive Generation of Fines

To determine if particle rupture (termed "explosive generation of fines") actually occurs a counting procedure was carried out. Narrow size fractions of trihydrate were obtained using electroformed sieves. Using an automated Elzone (electrozone sensing) the number of particles per gram was obtained for each size fraction. Weighed amounts of hydrate were placed in covered platinum crucibles introduced directly into a preheated furnace and held for one hour. The amounts were such as to provide only a monolayer on the bottom of the crucible to yield fast, efficient heating. After heating the total number of particles was obtained. The results are shown in Table I.

Table I. Effect of Temperature on Numbers of Particles

Hydrate	Size Fractions	110°*	300	500	700	900	1100
A	-106 + 75 μ m	770	870	800	740	820	750
B		800	770	850	790	760	760
C		850	800	-	-	880	-
A	-90 + 70 μ m	1880	-	-	2020	-	-
D		1910	-	-	1870	-	-
E		1920	-	-	1720	-	-
F	-90 + 75 μ m	1310	-	-	1280	-	-

* Initial trihydrate ** Average of three tests

The scatter is probably due to sampling, weighing and counting errors. If these are taken into consideration it becomes apparent that there has been no statistical change in numbers due to heating. The average count for all the tests on the -106 + 75 μm fraction (hydrates A, B and C) is 799 particles per mg while the average for the hydrate was 807. (Values for different hydrates can be combined since narrow size cuts have been taken). Similarly for the -90 + 70 μm cut the average number after heating is 1903 particles/mg vs. 1870 before heating. All of these values are well within the error limits.

To obtain additional evidence some microscopic work was done. Scanning Electron Microscopy was used on samples of material fractionated and heated in the same manner as for counting. No small particles could be found. Single particles examined microscopically before and after heating showed no evidence of breakage although cracks were in evidence.

All of the above indicated that if there was explosive fracture of particles it must be rare. We found one exception in all our work and that was for a hydrate from a new plant at start-up. For this material there was some evidence of particle generation.

Size Change of Particles

If tap density (TD) (defined in Appendix A) is plotted versus the temperature at which the hydrate was heated (Figure 1) at first the density falls and then it increases. (This phenomena is insensitive to the manner of heating.) The decrease might be explained by the loss of water but the increase can only be explained by the particle volume becoming smaller or the particle surface becoming smoother (permitting denser packing). We have no evidence of this latter in the laboratory so if it is assumed that there is no roughness change, then the particle volume must be shrinking. Hydrates from seven different producers were heated for several hours to various temperatures and the tap density and weight loss measured. The average results are given in Table II. The calculation method for all the volume and median shrinkages given in this Section are shown in Appendix B.

Table II. Effect of Temperature on Tap Density of Alumina
(Averages for Hydrates From Seven Different Producers)

Temperature, °C	110*	300	500	700	800	900	1000
Tap Density, g/cc	1.35	1.02	0.98	0.97	0.97	0.99	0.99
Weight Loss, %	0	26.0	32.6	33.8	33.5	34.4	34.5
Δ Powder Volume, %	0	2.1	7.2	7.9	7.4	10.5	10.7

* Initial trihydrates

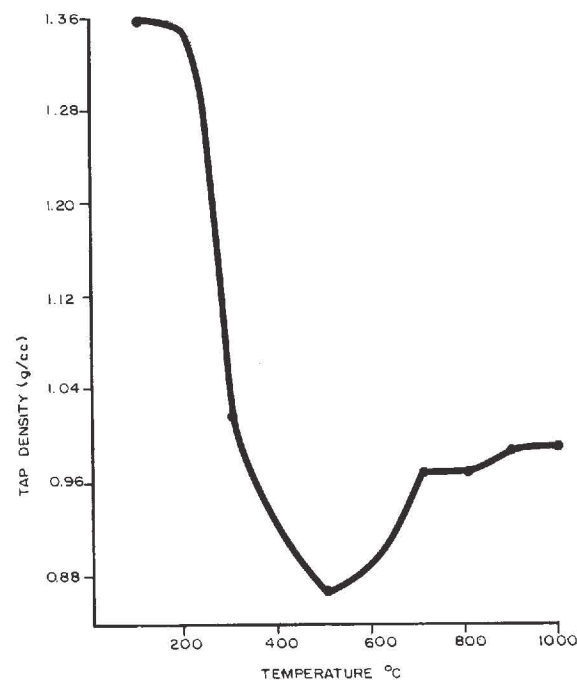

Figure 1 - The Generalized Effect of the Temperature of Calcination of Alumina Trihydrate on Tap Density

Assuming that surface roughness remains constant and that the only changes occurring are those measured (weight and density) plus shrinkage, the latter is readily calculated. It is ~ 11% by volume at 900°C.

The TD for commercial calciner products lies between about 1.00 and 1.20, the higher values being found for flash calciners. This corresponds to volume shrinkage of between 11 and 26%. Some of this variation may be due to generated fines and better flowability causing denser packing.

Another method of calculating shrinkage which is not influenced by flowability change is by determining the effective particle density by Hg porosimetry. Sufficient pressure is applied (very little more than atmospheric) to ensure the particles are completely encased in mercury but pores smaller than 7 μm have not been filled. The average effective density may then be calculated. Average data for the previous seven trihydrates are presented in Table III, assuming constant Hg contact angle. This method indicates that the particles shrank about 16% when heated to approximately 900°C. The calculation method is shown in Appendix B.

Table III. Effect of Temperature on Effective Density of Particles

Temperature, °C	110*	300	500	700	800	900	1000
Effective Particle Density, g/cc**	2.24	1.94	1.80	1.79	1.72	1.74	1.76
Weight Loss, %	0	26.0	32.6	33.8	33.5	34.4	34.5
Δ Powder Volume, %	0	14.6	16.1	17.2	13.4	15.5	15.4

* Initial trihydrates

** From Hg porosimetry data

If the volume shrinkage calculated for the laboratory calcined hydrates can be applied to individual particles, then tap density indicates a particle diameter decrease of 4%, and effective density a decrease of 6%.

Our microscopic studies (not detailed in this paper) of single particles before and after heating showed that the particle diameter shrank about 9% at temperatures of 800°C. This is slightly higher than that found by G. Zivkovic and Zilipovic⁽¹⁾ who used a hot stage microscope.

The most obvious method of detecting shrinkage is by particle size analysis before and after heating but we have found large variations within and among methods. The large number of analyses required precludes reporting the data in detail. The electrosensing zone technique finds an average diameter shift of 12%, about the same (10-18%) as found by Zivkovic and Zilipovic⁽¹⁾ who used sedimentation in isoamil alcohol. In many cases, exhaustive sieving using electroformed sieves agreed with electrosensing but occasionally much smaller changes were found. It is suspected that this latter is due to a roughness factor to which sieving is very sensitive.

It is quite certain that shrinkage occurs and when the concern is particle size measurements of hydrate versus alumina a factor must be used. Considering all the data available it would appear that 10-12% diameter shrinkage at the median is reasonable for sedimentation and electrozone sensing when the median particle size is between 60 and 80 μm. Sieving is less precise and perhaps less sensitive to volume shifts so unless long term averages are used the apparent shrinkage may be less.

For process control purposes it is normally the increase in the amount of fines (usually minus 45 μm) that is monitored. Our laboratory data (not reported here) indicates that there is an absolute shift of 1-3 percentage points at the 45 μm level due to shrinkage.

Effect of Heating on Powders

The degree of fragility is generally assessed by the generation of -45 μm material.

Examination of Powders for Breakage

Results from our "single particle" breaker, (discussed in Appendix A) indicated that particles which have been broken should be readily identifiable under the microscope. Detecting such breakage is difficult in the presence of a large amount of fines. Figure 2 is an example of this; it is the result of an attrition test on a fragile alumina. Since broken, but clean, particles should be readily recognized we washed the sample to be examined on a 45 μm, or smaller, sieve. The result is shown in Figure 3, a portion of the same sample as used for Figure 2. Some of the broken particles have been circled. This technique is especially useful when assessing attrition tests versus calciner output.

An examination by SEM of a number of hydrates and aluminas, (which have been calcined in various ways) before and after washing on the 45 μm sieve, points to the conclusion that generally fragility results in two effects. Fracture, the effects of which can be seen in the circled particles in Figure 3, (and even more visible in Figure A-2) is apparent in varying amounts in some aluminas after calcination and most aluminas after attrition testing. Attrition (the breaking-off of projections from the particles) produces fines, such as seen in Figure 2. These fines will be found in all aluminas which have been submitted to attrition testing and to some degree in most commercially produced aluminas. However, on a qualitative basis we could not identify how breakage occurred. There is no unique type of fracture.

The Effect of Rate of Heating on Powders

For years alumina was produced by essentially one method, rotary kilns. The rate of heating was slow and the conveying of the product down the kiln was relatively gentle. Fragility was of little concern. Fragility studies were done after calcining in static furnaces in the laboratory where the heating rate was even slower and there was essentially no agitation of the bed. The advent of the flash calciner, with and without a fluid bed, changed these conditions. The static bed laboratory calcination was giving higher fragility than was being found in practice. In addition, the Attrition Index (AI) test, (described in Appendix A) was being challenged since it was performed on the cold product. Thus our studies were extended to faster calcination rates, the products of which could be examined for fines due to attrition (i.e. a high temperature attrition test).

Static Calcination Tests

To obtain a base-line, long term heating (24 h) was performed on hydrates from various producers. The temperature was raised slowly (about 5°/min.) to prevent loss. In some cases only small amounts of hydrate were available so the attrition testing was done by our modified method (described in Appendix A) on all samples. The results are slightly different from the standard test but are self-consistent. A tabulation of a representative selection of samples is given in Table IV. For some producers more than one sample of hydrate was obtained but for different dates, (indicated as 1 and 2). Some samples were very small, limiting the number of tests.

An examination of all the data we have (most of which is not reported here) indicates that there is a trend - there is a sharp increase in fragility after calcination to 240-300°C, and then a further general rise followed by falling off. A plot is shown in Figure 4.

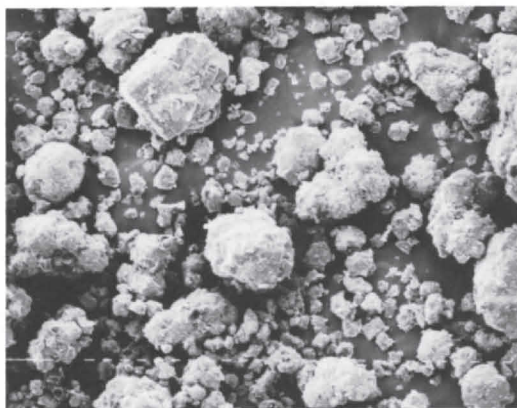

Marker Bars - 10 μm

Figure 2 - Appearance of Particles after Submission to Attrition Test

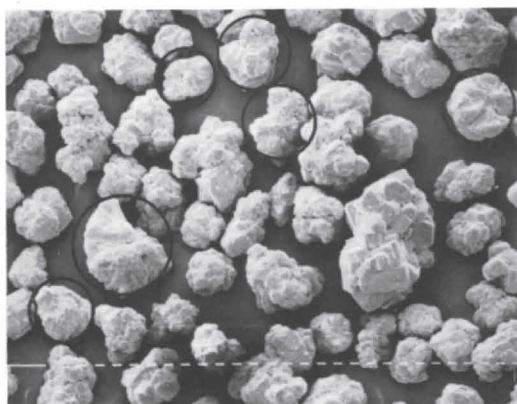

Some of the fractured particles are circled. Marker Bars - 10 μm

Figure 3 - Test Residue After Washing on 45 μm Sieve

Table IV. Laboratory Calcination of Alumina Trihydrate - Static Heating

Hydrate Source	24 Hour Retention Time* - Modified Attrition Index**									
	A		B		C		D	E		
	1	2	1	2	1	2	-	-		
°C										
110	-	1	-	6	1	1	1	3		
200	6	-	2	-	-	-	-	-		
240	20	-	19	-	17	-	-	-		
300	18	20	17	7	15	9	3	-		
350	24	17	20	9	17	-	-	-		
430	25	-	22	-	22	-	-	-		
500	29	19	24	19	22	12	4	-		
700	32	17	24	18	23	-	5	-		
800	-	20	-	22	-	-	5	-		
900	37	21	35	28	31	19	12	38		
1000	-	27	-	21	-	17	9	27		

* time material was at temperature after heat-up rate of 5°/min

** small sample technique

Further static tests were run having shorter and shorter holding times at temperature. To ensure that all the material was at temperature for the stated period only small amounts were placed in shallow, platinum pans. The heat-up rate was dependent upon final temperature but rarely exceeded 30 min. The effect on fragility, as assessed by the modified AI method on three hydrates, is shown in Table V.

An average has been included since all the values for any one temperature are approximately within the error of sampling and analysis. For this shorter time there is an apparent stability above 300°C. This is shown in Figure 5.

Table V. Laboratory Calcination of Alumina Trihydrate - Static Heating

Hydrate Source	0.5 Hour Retention Time* - Modified Attrition Index**			
	A	B	C	Ave.
°C				
200	3	5	3	4
240	4	6	4	5
300	20	15	14	16
350	13	12	16	14
430	14	13	11	13
500	11	14	12	12
700	12	15	12	13
900	10	14	14	13

* time material was at temperature with heat-up time averaging 30 min

** small sample technique

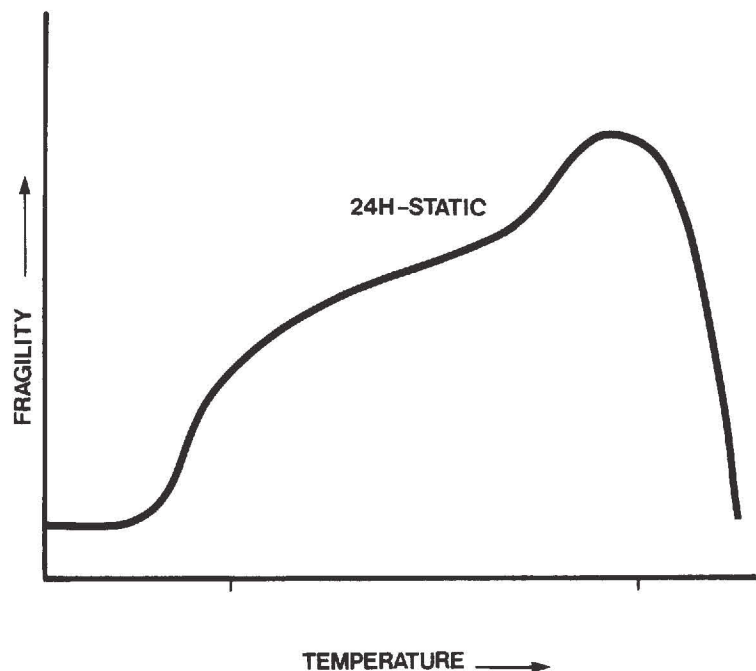

Figure 4 - Effect of Quiescent Heating for Long Periods on Fragility (Attrition Index) of Alumina

Fluid Bed Tests

Using the tilting furnace fluid bed described in Appendix A we were able to increase the rate of heating to the limit imposed by dehydration rate. Table VI presents data obtained on one hydrate, comparing these values to what was found for static calcination. Cold runs were made, using commercial smelter-grade alumina, to assess breakdown due to velocity alone. Changes in the fines were all within the error due to sampling and analysis.

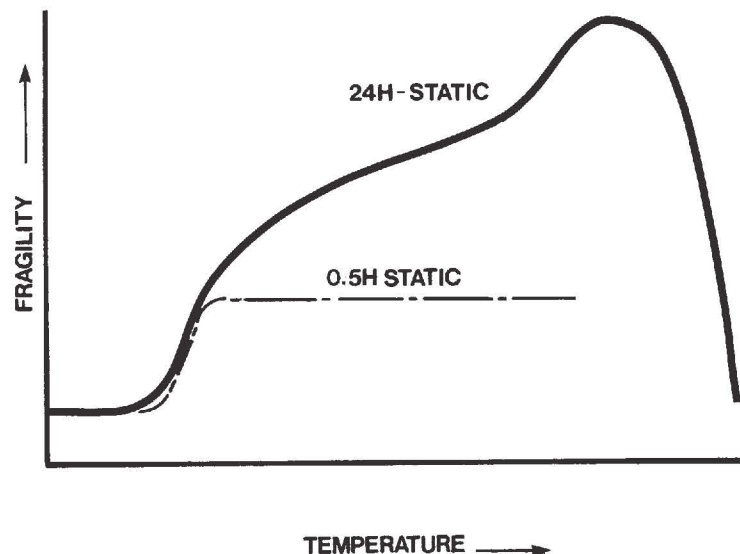

Figure 5 - Effect of Time at Temperature with Quiescent Bed on Fragility (Attrition Index) of Alumina

Table VI. Comparison of Modified Attrition Index for One Hydrate with Rate of Heating

°C	Static Heating Holding Time**		Tilting Fluid Bed Total Furnace Time			
	24 h	0.5 h	0.5 h	0.3 h	0.08 h	0.02 h
200	1	3	2*	2*	2*	2*
240	17	4	-	-	-	-
300	15	14	1	-	3	1
350	17	16	-	-	-	-
430	22	11	-	-	-	-
500	22	12	5	2	3	2
700	23	12	5	7	6	2
900	31	14	5	5	8	5

* Average of dried hydrate

** Heat-up time as per Tables IV and V, not included.

The difference between the static heating and fluid bed for 0.5 h is probably due to heat up time. The former required about 30 minutes to reach temperature and then was held at temperature for the stated period while for the tilting furnace the time stated in the table was the total time in the furnace. It is readily apparent that the faster heating rate has considerably reduced the AI. Figure 6 indicates that in the laboratory by shortening the heat-up and holding times the fragility is lower. Furthermore most of the fragility is being generated early in the calcination process.

Flash Heating

The reason for this step was two-fold. The first was to determine if by further speeding up the heating rate and shortening the time at temperature a lower fragility would result. The second was to obtain an index of fragility via break-down during processing rather than an after-the-fact laboratory method run at room temperature.

An equipment diagram of our laboratory scale fast-fluid bed heater is presented as Figure 7. The temperature range for the transporting gas was from 250°C to 450°C. The gas velocity at the entry to the cyclone ranged from 15 to 32 m/s. The conditions for one particular run are shown on the diagram. Cold runs indicated that breakage of alumina was minimal in our equipment, therefore any increase in fines would be due to processing at higher temperatures. However, it was found that the increases in fines were quite small (frequently within the error of the method) which effectively prevented us from using this technique as a direct indicator of fragility. The AI was also determined on the product. Hydrates from four sources were used.

The trends in AI were the same as previously found but slightly lower although there was considerable scatter in the data. This lower level may only be due to the hydrate used for these runs and not to a decrease in fragility. The trend line for the fines generation in the processing, followed that for AI, the increase occurring at about 350°C,

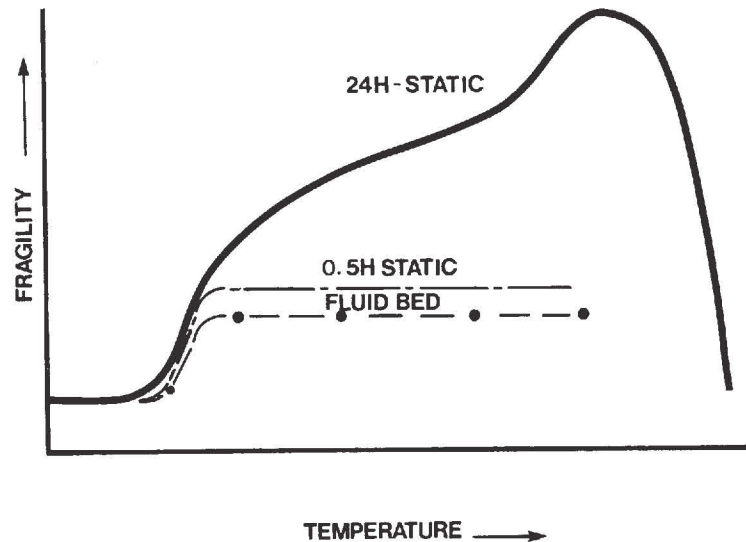

Figure 6 - Effect of Heat-up and Holding Time at Temperature in a Fluid Bed on Fragility (Attrition Index) of Alumina

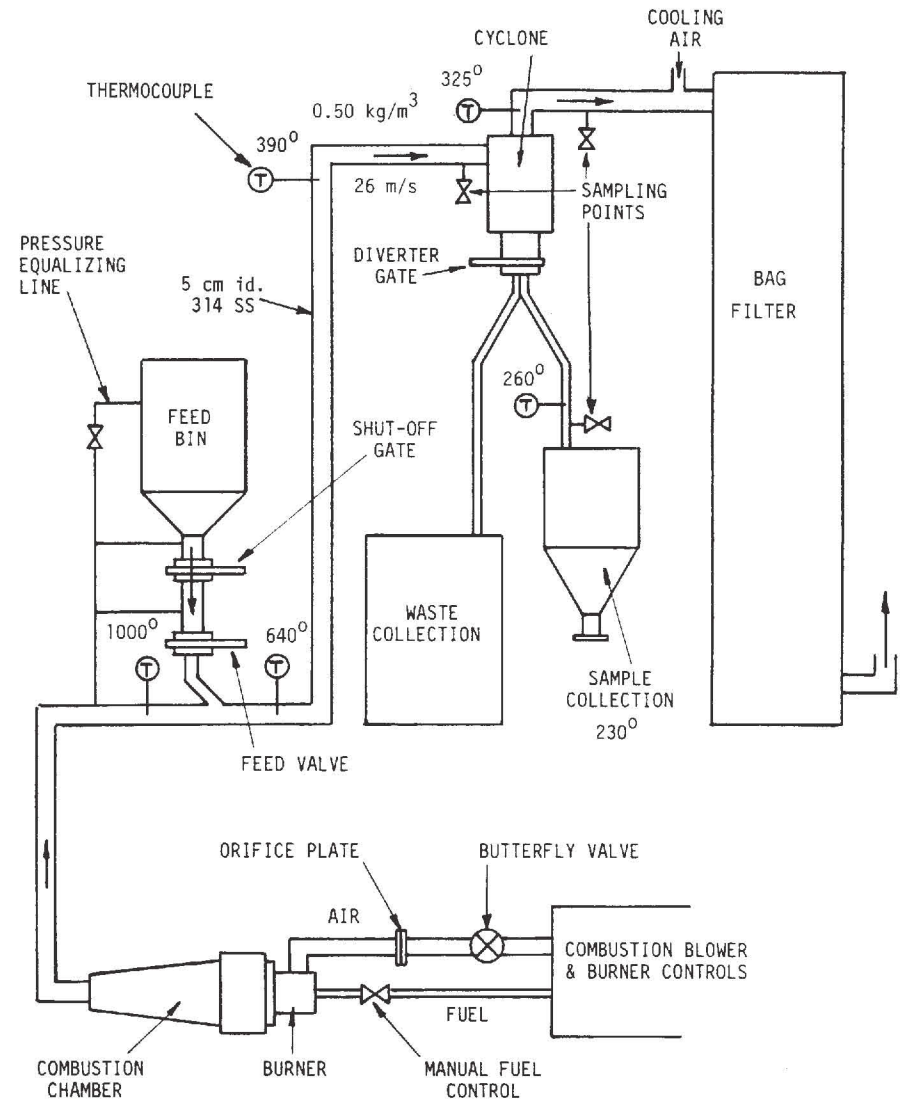

Figure 7 - Equipment Diagram for Laboratory Flash Heater. (Temperature, flow, and solids loading shown for an average run)

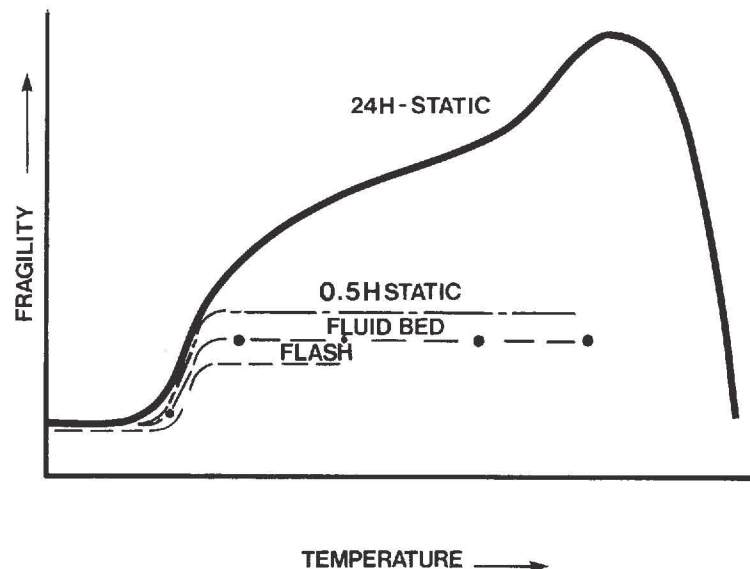

Figure 8 - Effect of Heat-Up and Holding Time on Fragility (Attrition Index) of Alumina

gas temperature. The estimation of the temperature of the solids is difficult since the time of hot gas/solids contact was only about 0.7 s and dehydration is not complete. Therefore gas temperatures are quoted but the temperature of the solids was definitely below the gas temperature. A summary curve for all our findings regarding the generation of fragility versus temperature and rate of heating is shown in Figure 8.

Examination of the product by SEM revealed almost no fracturing but there was generation of a small amount of very fine material.

Summary

When examining a calciner product with respect to fines generation attributed to attrition and fracture, particle shrinkage must be kept in mind. The most likely effect is a 1-3 percentage point increase in the amount of $-45 \mu\text{m}$ material.

We have shown that explosive generation of fines does not occur under laboratory conditions. The fines generated in most commercial processes are therefore probably due only to shrinkage and to attrition.

Our laboratory work to date (summarized in Figure 8) indicates that slow heat-up times and long times at temperature give the most fragile material. As these times become shorter the fragility becomes less and there is little or no increase after the initial generation. Flash heating gives the lowest fragility.

Bibliography

- (1) Zivkovic, Z.D. and Zilipovic, M., Change of Granulometric Composition During Calcination of Aluminium Hydroxide, ICSOBA - AIM Conference, Cagliari, Italy, 26 September 1979.
- (2) Forsythe, W.L. and Hertwig, W.R., Attrition, Fluid Cracking Catalysts. Laboratory Studies. *Ind. Eng. Chem.*, June 1949, pp. 1200-1206.

Appendix A

Definitions and Test Descriptions

Tap Density - 200 g sample in a 250 cc graduate, tapped by dropping 30 mm to a hard rubber mat 100 times. Volume measured, and value reported as g/cc.

Effective Particle Density - Mass of a particle divided by the volume of the particle including both open and closed pores.

Particle Breakage

As shown in Figure A-1 a holder was built to accommodate a micrometer and a microscope at right angles. The micrometer holder permitted the micrometer to be tilted so that the broken particles could be recovered. The microscope was focused on the anvil face of the micrometer which was illuminated by a microscope light.

The particle(s) to be broken, previously fractionated into narrow size cuts, were placed on the anvil face and while watching carefully through the microscope the spindle face was brought into contact with the particle. Then a short, sharp turn of the friction drive knob was made. This procedure required some experience to prevent over-breaking. The broken pieces were then transferred to a stub and examined by S.E.M. Examples of what we saw are given in Figure A-2. It will be apparent that more than one particle was present since we did not perfect the technique of placing only one particle at a time on the anvil face. Also not all broken pieces were so clearly placed on the stub as these. However, no evidence was found that breakage occurred along any particular plane for either hydrate or alumina. Sometimes the particle broke completely across a plane while in other cases pieces had broken out.

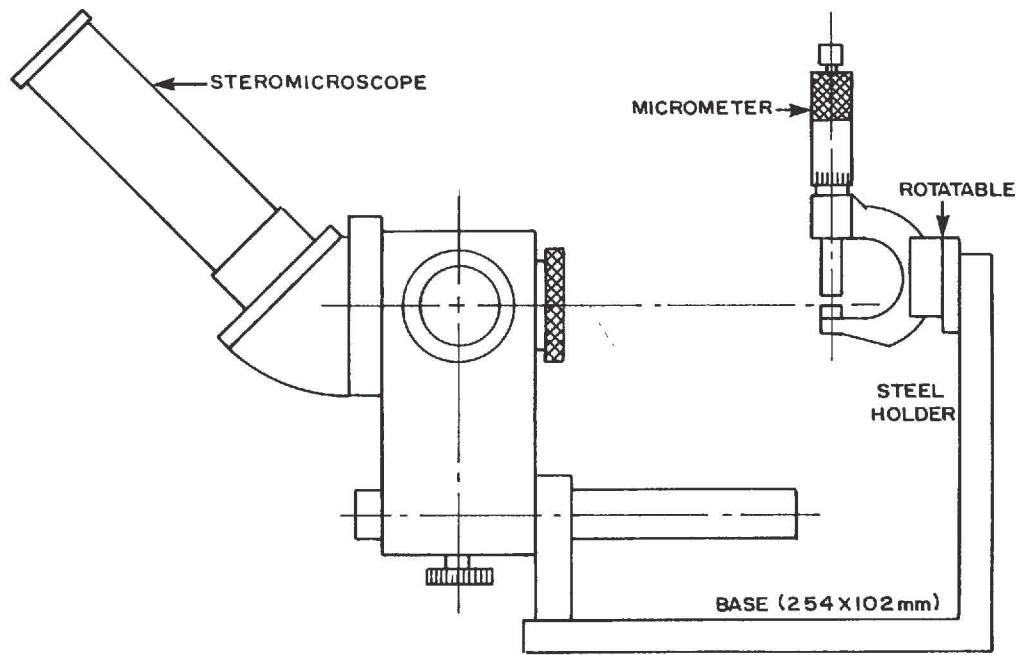
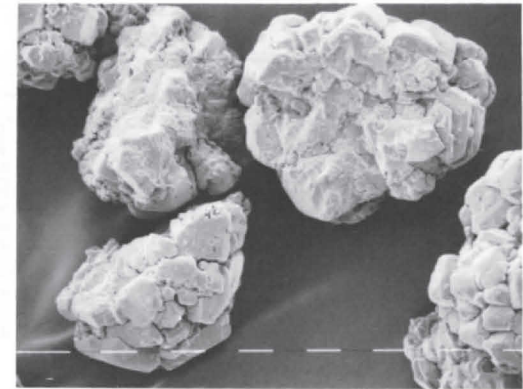
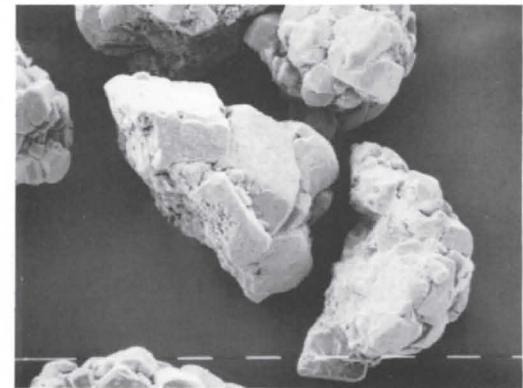

Figure A-1 - Device for Breaking of "Single Particles" of Alumina



Marker Bar - 10 µm



Marker Bar - 10 µm

Figure A-2 - Examples of Alumina Particles Broken by "Single Particle" Breaker

Attrition Testing

The best-known method is the so-called modified Forsythe-Hertwig Attrition Index⁽²⁾ (AI). (A schematic of the equipment is shown in Figure A-3.) The method involves a very vigorous agitation of 50 g of sample in a 25 mm diameter tube by means of a high pressure air-jet at the bottom. The percent of generated fines is determined by Ro-tap sieve analysis. In our early work we found that the precision among laboratories for this method was rather poor. We had purchased orifice plates in the hope of standardizing the air-jet but a quick microscopic examination indicated that they were very poorly made and non-uniform. We then undertook to make them ourselves using the same machinist with the same drill. Afterwards they were verified by microscope and by applying a standard gas pressure and measuring the flow. This new orifice plus a careful sieve analysis yielded an interlaboratory (2σ) precision of about $\pm 3\%$ for the AI.

The experimental calcination work sometimes produced very small quantities of product which could not be handled by the standard method. For this we modified the method and used only 10 g of sample for the attrition and the Elzone (electrozone sensing) for size analysis. The conditions for the attrition are - a gas pressure of exactly 400 kPa, a gas flow of approximately 100 cc/s, and an agitation time of 300 seconds. Very careful sampling is required to obtain a precision equivalent to the regular method.

Frequently it was desired to assess a hydrate but on a calcined basis. For this, very careful calcination was required to avoid dust losses and particle breakage due to agitation. Flat-bottomed calcination dishes were used. Dried hydrate was placed in the dish in the amount of about 0.3 g/cm² of bottom area. A minimum of 20 g of hydrate total is required for the test. The heating is controlled so that the furnace temperature rises from ambient to 300°C in 30 minutes, held there for one hour, then raised to 900°C in 60 minutes and held for another 60 minutes. This technique produces comparable results for various hydrates since all particles have reached the 900°C with minimal loss.

Fluid Bed Test Equipment

Our equipment consisted of a 5 cm stainless steel tube having a piece of porous brick as a diaphragm. A thermocouple is placed through this diaphragm from the bottom, such that the tip was just above the surface and would be immersed in the bed of alumina during heating. The fluidizing gas was nitrogen. The tube was closed at the bottom save for the gas and thermocouple entries. The tube below the diaphragm was filled with alumina balls to act as a gas preheater. At the top there was an alundum thimble held tightly against the tube to act as a dust collector. The tube was held in a furnace heated by Kanthal heating elements. The whole apparatus was held in a cradle which permitted it to be rotated rapidly. Figure A-4, shows photographs of the equipment.

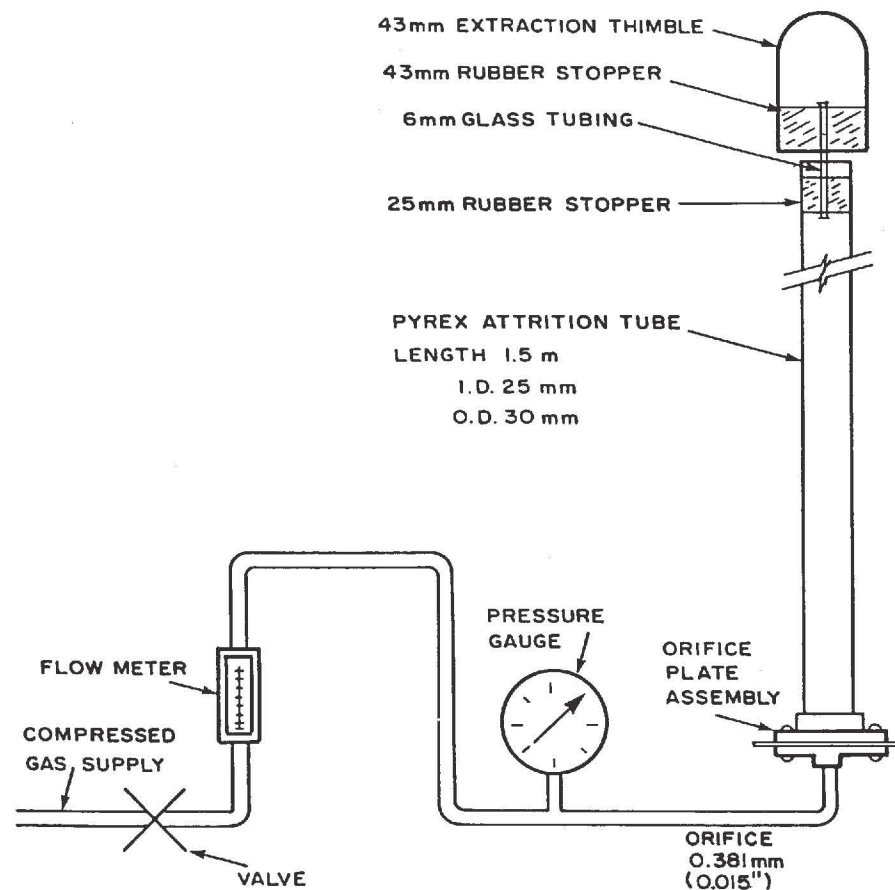
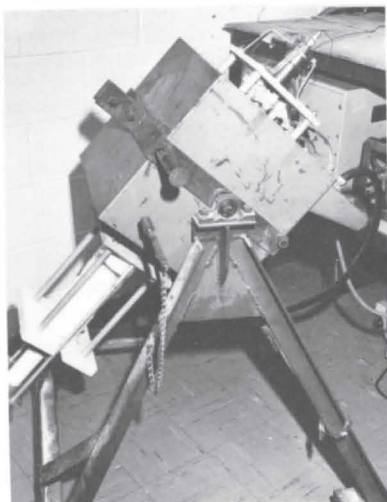
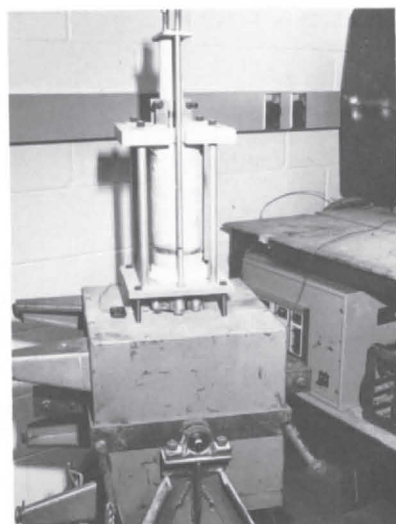

Figure A-3 - Required Equipment for the Modified Forsythe - Hertwig Attrition Index Method



Loading & Emptying Position. Note alundum thimble lower left and fluidizing gas and thermocouple entry at other end of stainless tube



Operating Position. Diaphragm is at turning axis of furnace

Figure A-4: Rotating Fluid - Bed Laboratory Furnace

The operation of the equipment was simple. The furnace was brought to temperature while tilted so that the end holding the thimble was downward. The sample of hydrate was placed in the thimble and when the furnace was at temperature the thimble was placed in the holder. The furnace was then rapidly tilted upright so that the hydrate dropped down to the diaphragm. Gas was started after a few seconds since the bed was fluid at the beginning due to the release of water. The gas velocity at temperature was 3 m/s. When the calcination was completed the furnace was inverted and the sample removed from the thimble.

Appendix B

Examples of Shrinkage Calculations

Change in Tap Density (TD) 1.35 → 0.99

Weight Loss (H₂O) 34.4%

For a volume of 100 cc and TD of 1.35 - weight = 135 g

Same volume of hydrate heated to 900° now weighs 135 × 0.656 = 88.6 g

To obtain a TD of 0.99, the volume must = 88.6/0.99 = 89.5 cc

$$\therefore \text{Volume change} = \frac{100 - 89.5}{100} = 10.5\%$$

Change in Effective Density (ED) - 2.24 → 1.74

Weight Loss (H₂O) = 34.4%

For a volume of hydrate of 100 μm³, weight = 224 μg

Same volume of hydrate heated to 900° now weighs -

$$224 \times 0.656 = 146.9 \text{ ug}$$

To obtain an ED of 1.74, volume = 146.9/1.74 = 84.5 μm³

$$\therefore \text{Volume Change} = \frac{100 - 84.5}{100} \times 100 = 15.5\%$$

Assuming the median sized hydrate particle is 80 μm and this volume change can be applied directly, then the shrinkage on the median diameter =

TD = 4%

ED = 5.5%