

ALUMINA HANDLING DUSTINESS

Monique Authier-Martin

Alcan International Limited, Arvida Research and Development Centre

P.O. Box 1250, Jonquière, Québec, Canada, G7S 4K8

Dustiness of calcined alumina is a major concern, causing undesirable working conditions and serious alumina losses. These losses occur primarily during unloading and handling or pot loading and crust breaking. The handling side of the problem is first addressed. The Perra pulvimeter constitutes a simple and reproducible tool to quantify handling dustiness and yields results in agreement with plant experience. Attempts are made to correlate dustiness with bulk properties (particle size, attrition index, ...) for a large number of diverse aluminas. The characterization of the dust generated with the Perra pulvimeter is most revealing. The effect of the addition of E.S.P. dust is also reported.

INTRODUCTION

Handling of large tonnages of powders is a major concern in many industries because of the airborne dust generated in the working environment, primarily during loading and unloading operations. This problem has also been nagging the aluminum industry and specifically so in the area of alumina dustiness.

Even though metallurgical-grade alumina is not noxious by its chemical nature, the particle size and quantities of airborne dust may be considered health hazards (1). Alumina may also become an excellent adsorbent for other substances which may have toxic effects when inhaled. Moreover, alumina dustiness constitutes an important economic loss for reduction plants. It is estimated that alumina losses can reach approximately 10,000 MT/year for a major reduction plant, costing around US\$2,500 K. It is thus important to reduce the dust generated in order to improve working conditions and to offset unwarranted economic losses.

BACKGROUNDAlumina Dustiness

The largest portion of alumina losses and the deterioration of working conditions due to alumina dustiness occur primarily during:

- unloading and handling of alumina
- pot loading and crust breaking.

Alumina dustiness is basically related to two very different phenomena, named respectively handling and flash dustiness, both associated with a more global environmental condition called haze dustiness. Handling dustiness is a physical problem caused by

the thrust imparted to particles such as when alumina hits a pile or a rigid structure. Particles of alumina may also interact with each other in "free-fall" or when subjected to air currents, interactions which can well be repulsive and at the origin of the airborne dust. Flash dustiness occurs when alumina hits the hot electrolytic bath surface and is related to chemical or thermal effects. The airborne dust generated in either case creates a haze in the working environment, leading to safety problems and worker's complaints, and also - but not least - to important economic losses.

Alumina dustiness has been a re-occurring concern within the aluminum industry, but there seems to be a serious lack of systematic approach which led to a mass of scattered information, without much understanding of the phenomenon and hence, the necessity to rely solely upon plant experience - meaning generally worker's complaints. Without sound specifications, rejection criteria are generally based on impressions or preconceived ideas, and plant operations may regularly suffer from the chaos thus created.

The Perra Pulvimeter

A renewed interest has flourished since 1984 with the appearance of the Perra pulvimeter (2). Designed originally by S. Perra of Eurallumina, on a somewhat different principle than the standard device to measure dustiness of coal and coke (3), the instrument was later improved and the measurement procedures better described by H.P. Hsieh from ALCOA (4).

A schematic drawing of the Perra pulvimeter is presented in Figure 1. A fixed amount of alumina (250 g) is suddenly dropped from a feeding funnel onto an inverted diffuser cone. The airborne dust, generated during the fall of the alumina and caused by the mechanical thrust applied by the rigid cone structure on the alumina particles, is collected in a small collector cup placed underneath the inverted cone. The quantity of dust collected (mg) is weighed and ratioed over the mass of alumina (g) to give the so-called dustiness index, D.I., expressed in kg dust/ton Al_2O_3 .

The Perra pulvimeter seems a promising tool to measure handling dustiness behavior, the device having two outstanding qualities:

- good reproducibility, of the order of 6-8 % rel.
- preliminary data in agreement with plant observations (4).

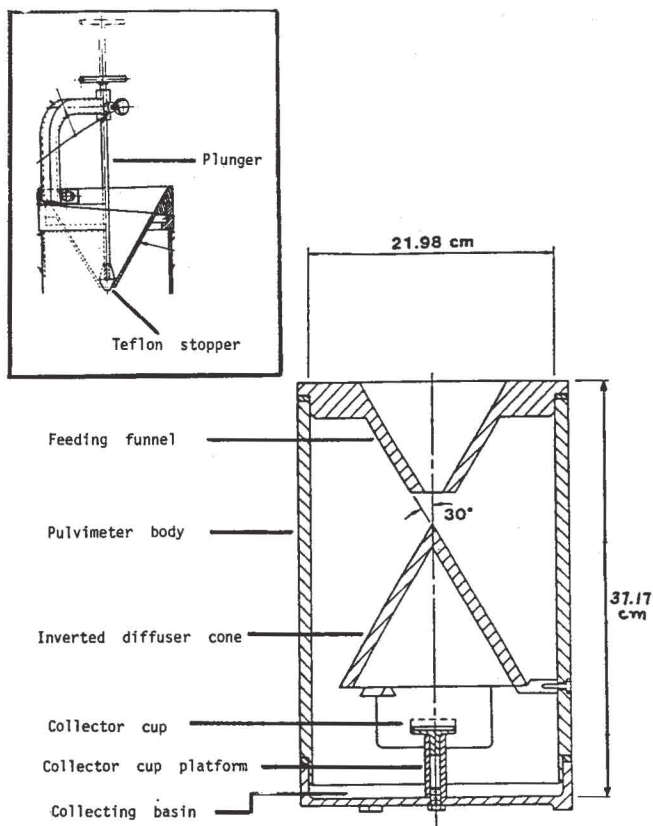

Figure 1. Simplified drawing of the Perra pulverimeter (as per ref. 4).

Hsieh (4) showed that moisture and the amounts of electrostatic precipitator (E.S.P.) dust added were among the critical parameters linked to alumina dustiness, as measured with the Perra pulverimeter. Using also the Perra pulverimeter, Lalancette (5) has established another interesting correlation (Figure 2). He found that the dustiness index was in direct correlation with the % - 20 μm (or % - 33 μm) fraction present in several alumina samples - samples produced by the same plant at a time when E.S.P. dust was recirculated in the fluid flash calciner kiln.

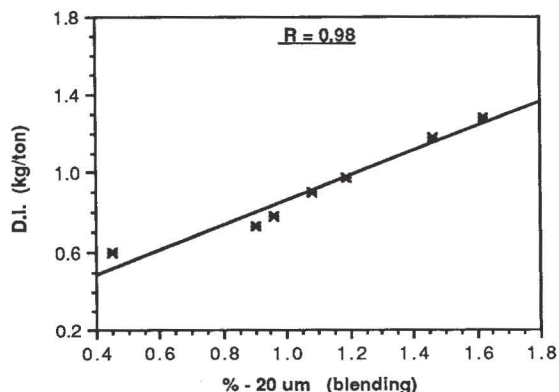

Figure 2. Dustiness index and particle size of alumina samples (fluid flash calciner, 1984) (as per ref. 5).

SCOPE

So far, dustiness measurements have been limited to a single source of alumina or to very few different samples (2,4,5), with no attempt for a systematic comparative study between aluminas from different origins. The experimental program we laid out had the following goals:

- Evaluate the performance of the Perra pulverimeter with typical metallurgical-grade aluminas from a large number of alumina plants
- Correlate dustiness behavior, that is the dustiness index, with bulk properties such as those routinely measured for quality or control purposes
- Achieve a preliminary understanding of handling dustiness of sandy aluminas

RESULTS AND DISCUSSION

Dustiness Index of Typical Aluminas

Fourteen samples collected in 1985 from 12 Bayer plants were first tested with the Perra pulverimeter (Table I). Dustiness indices ranging from 0.5 to 2.4 kg dust/ton Al₂O₃ were obtained for these typical plant samples. The relative standard deviations on the dustiness index varied from < 1 % to 28 % and were typically of the order of 10-15 %, corresponding to a precision of 0.1-0.2 kg/ton at the 0.8 to 2.5 levels. The repeatability found was lower than the one reported by Perra, (5 % (2)) or Hsieh (6-8 % (4)) because the tests were carried not on the same portion, that is alumina + dust re-mixed, but on different sample portions prepared using a rotary divider.

Table I ranks aluminas in three categories:

- Group 1: with dustiness indices well below 1.0 kg dust/ton Al₂O₃
- Group 2: with D.I. between 1.0 and 2.0 kg/ton
- Group 3: D.I. above 2.0 kg/ton

Table I. Dustiness Index of Sandy Aluminas. Perra pulverimeter (kg dust/ ton Al₂O₃)

Sample *	1985	1986
Plant #1	0.50	0.45
Plant #2	0.54	0.42
Plant #3	0.81	0.41
Plant #4	-	0.65
Plant #5	0.85	1.44
Plant #9a	1.07	-
Plant #6	1.18	1.55
Plant #7	1.28	1.66
Plant #8	1.32	1.33
Standard	1.50	1.52
Plant #9	1.64	2.23
Plant #10	1.68	1.15
Plant #9b	2.08	-
Plant #11	2.34	-
Plant #12	2.41	-
Plant #13	2.44	-

* Annual composites, except for 9a and 9b (grab)

Values recorded for the 1985 samples were generally confirmed in 1986, aluminas having shown low dustiness indices in 1985 still exhibiting the same characteristics in 1986.

Based on these preliminary results, the Perra pulvimeter was shown to be a simple, quantitative and reproducible means to measure handling dustiness. Even more important, it is a reliable instrument as it yields results in agreement with observations made at different smelters using aluminas from various sources.

Dustiness Index and Bulk Properties

Attempts were made to correlate dustiness indices, measured using the Perra pulvimeter, with alumina bulk properties, such as:

- particle size distribution
- alpha-alumina content ($\alpha\text{-Al}_2\text{O}_3$)
- loss of mass (L.O.M. 300-1100°C)
- attrition index (A.I.)
- specific surface area (SSA)
- angle of repose
- permeability
- flowability
- minimum or maximum bulk density.

With values ranging between 31 and 33 degrees, the angle of repose does not correlate well with the dustiness index. Because of its lack of discrimination, (21 out of 22 values equal to 1), flowability measurements must also be ignored. No straightforward correlation (R values well below 0.30) can be found between the dustiness index and either $\alpha\text{-Al}_2\text{O}_3$, A.I., SSA or permeability (Figure 3).

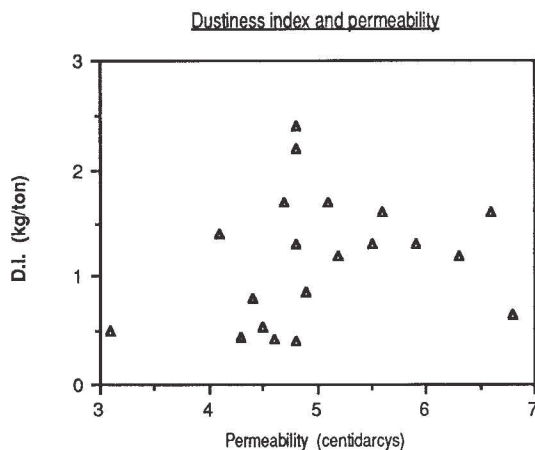
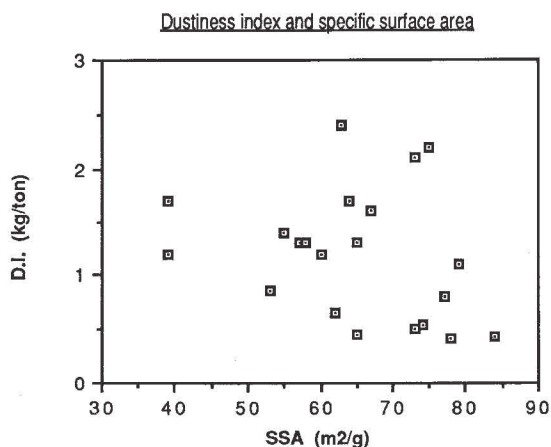
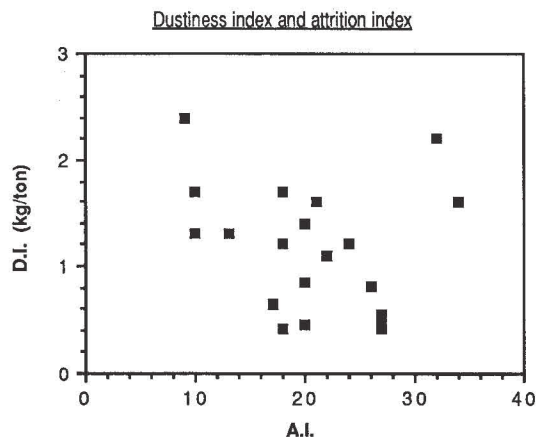
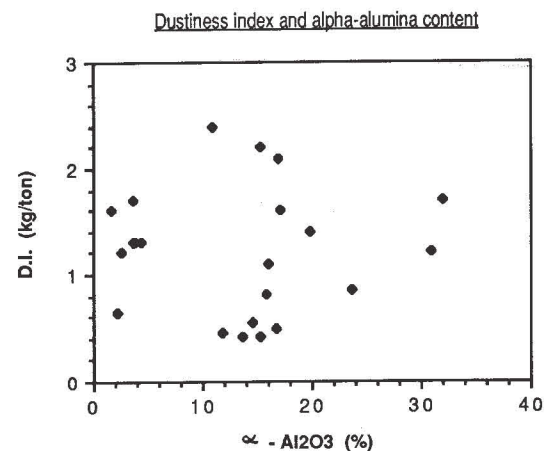

Figure 3. Correlations between the dustiness index and alpha-alumina, attrition index, specific surface area and permeability for 1985/1986 alumina samples from different Bayer plants.

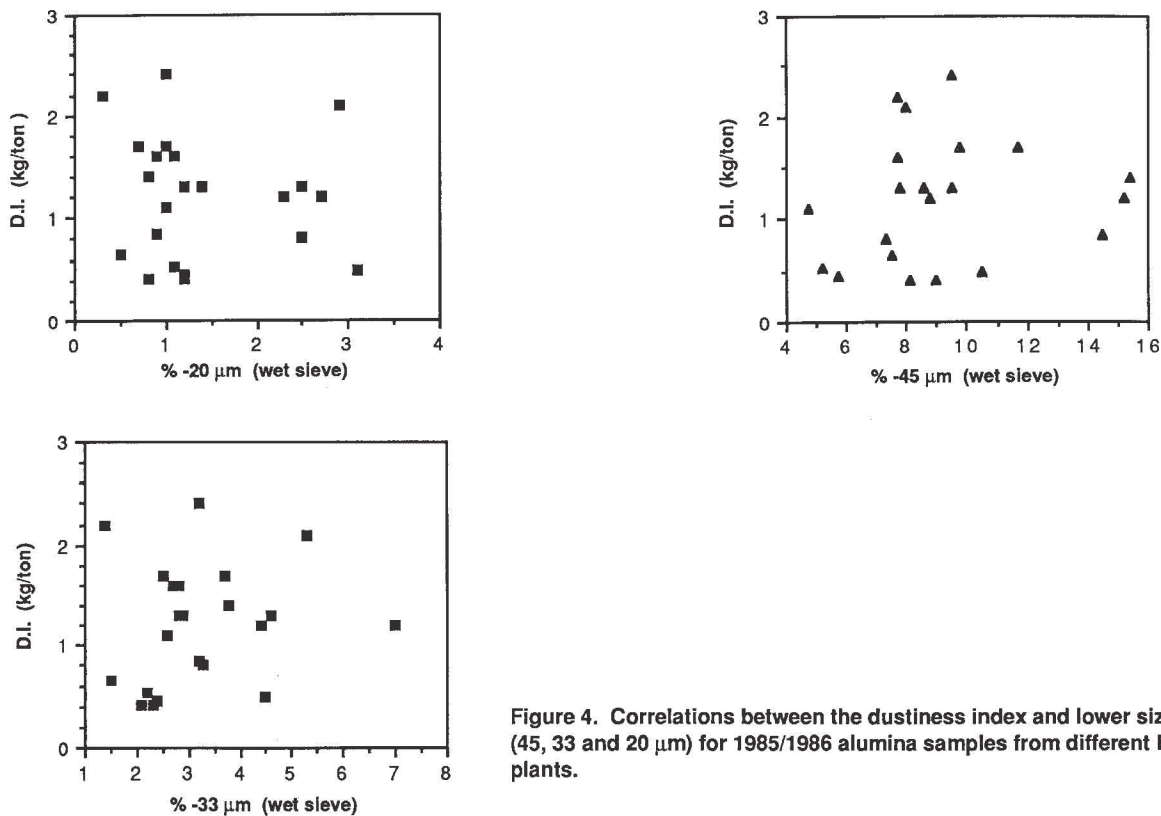

Figure 4. Correlations between the dustiness index and lower size fractions (45, 33 and 20 μm) for 1985/1986 alumina samples from different Bayer plants.

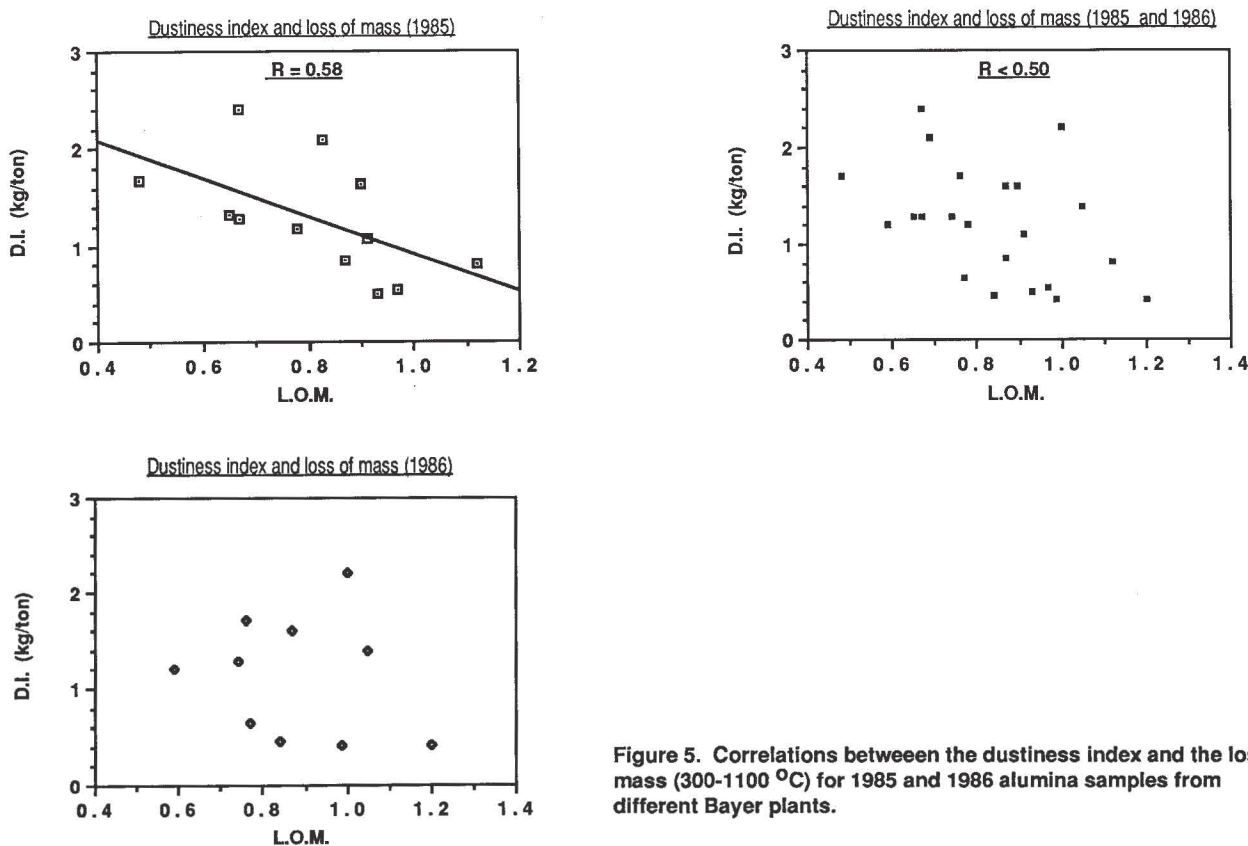

Figure 5. Correlations between the dustiness index and the loss of mass (300-1100 °C) for 1985 and 1986 alumina samples from different Bayer plants.

When considering aluminas from different plants, the dustiness index is not related to the lower size fractions of the particle size distribution (Figure 4: R values all below 0.20). It must be stated though that the correlation might well stand up for alumina samples from a single plant, as it was the case in Lalancette's work (5). Broad trends were observed with the loss of mass for the 1985 samples ($R = 0.58$), but were not confirmed with the 1986 samples ($R < 0.20$) or when both sets of data were compiled together ($R < 0.50$) (Figure 5). Fair correlations were established with the bulk densities (Figure 6), but were not helpful in understanding clearly what makes an alumina particularly dusty. It must finally be mentioned that dustiness behavior cannot be related to the type of calciner used (rotary kiln or fluid flash calciner) to produce sandy aluminas.

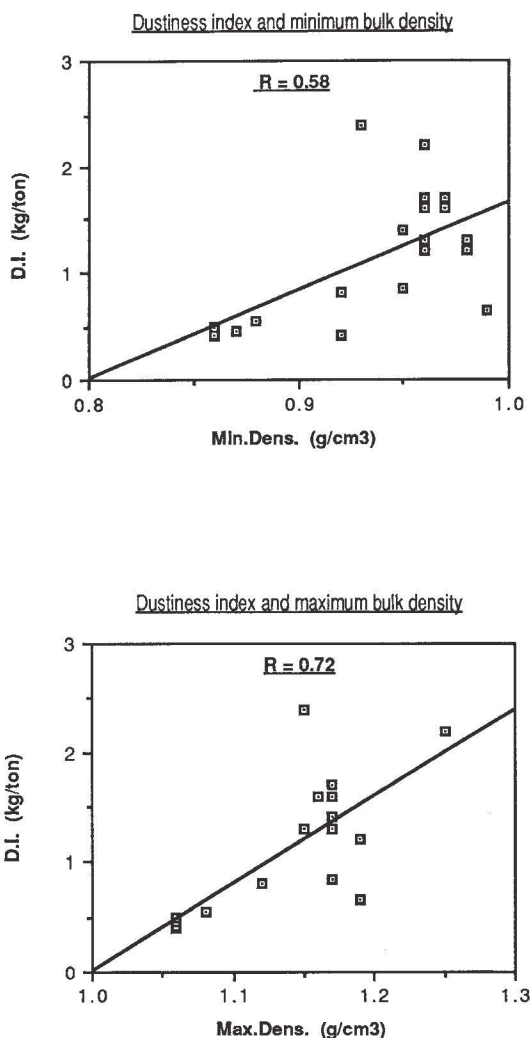

Figure 6. Correlations between the dustiness index and minimum/maximum bulk densities for 1985/1986 alumina samples from different Bayer plants.

Dustiness Index and Attrition Profile

Considerable handling operations are usually involved to deliver alumina from the Bayer plants to the electrolytic cells. The question thus arises whether handling dustiness is created by particle breakdown within the handling systems (conveyor-belts, air slides, vacuum unloading and transport to and from bulk carriers, dry scrubbers, storage silos, etc.).

The attrition index test was designed to provide such information and is meant to measure the fragility of alumina based on the decrease of a reference size fraction ($45 \mu\text{m}$), before and after the attrition test is carried out (6,7). The test ignores what is happening to the higher size fractions, consequently losing some valuable information (Figure 7). Looking at the breakdown pattern over the whole size distribution range (150 to $45 \mu\text{m}$), we may be able to assess which size fraction is most sensitive to mechanical shock. This breakdown pattern is labelled herein an "attrition profile" and it seems interesting to compare it with the dustiness index measured with the Perra pulvimeter.

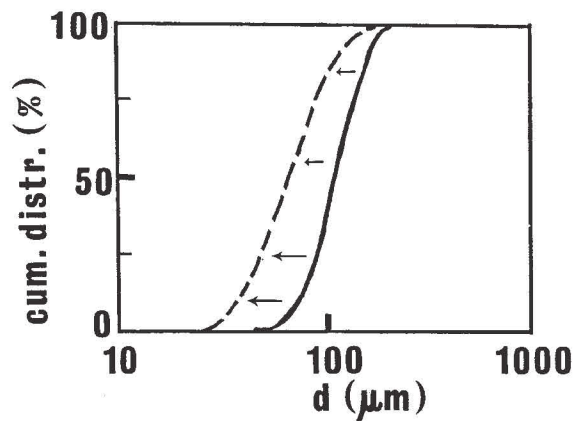

Figure 7. Cumulative weight distribution (% finer than) before (—) and after (---) the Forsythe-Hertwig attrition test.

The 53 and $45 \mu\text{m}$ fractions were both equally affected by the attrition test for the samples tested and showed the highest decreases in weight before and after the attrition test. Comparing the magnitude of this weight decrease with the dustiness index for several alumina samples, there seems to exist an inverse trend for the size fractions 75 , 53 and $45 \mu\text{m}$ (Figure 8): as the particle breakdown increases - that is as the size fraction weight loss increases - the alumina sample becomes less dusty. The only disturbing factor is the presence of apparently two outliers; these data belong to alumina samples from Plant #9 and may be ignored since the samples were collected at a time when process changes occurred and less than steady state conditions might have prevailed. The trend is still evident with the 105 size fraction, but it is less sharp ($R < 0.40$).

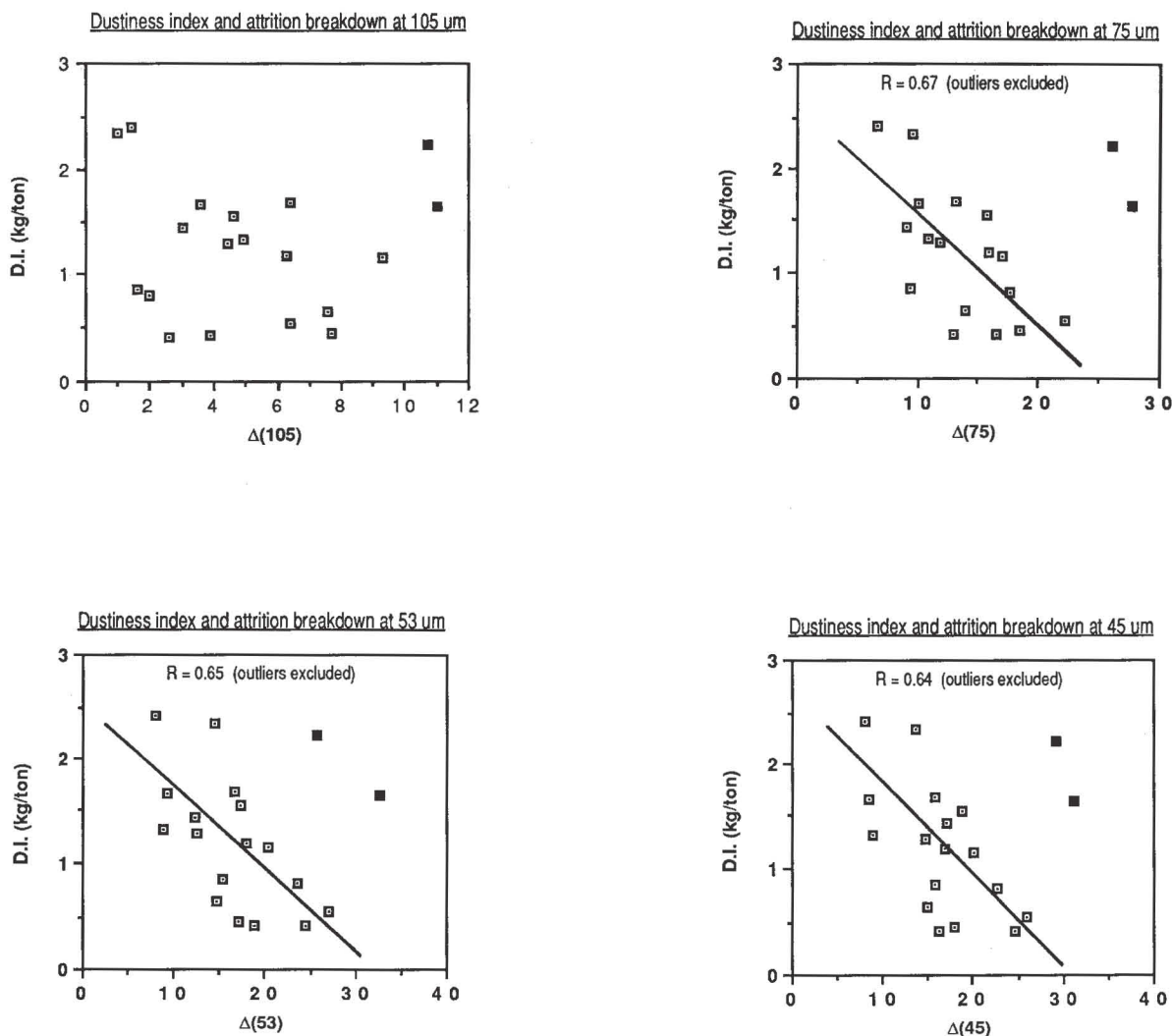

Figure 8. Correlations between the dustiness index and the "attrition profile" for 1985/1986 alumina samples from different Bayer plants (■ outliers excluded) (Δ 105 : difference in size fraction weight (%) before and after the attrition test).

This correlation is undoubtedly not in line with general preconceived ideas that tend to link dustiness with fragility. Aluminas that are easily attrited produce fine particles - but it seems not of the "dusty" type. S.E.M. micrographs of strong aluminas do not reveal any unusual surface or crystal shape feature. More work is planned in this area to help understand this unexpected behavior. It was therefore assumed to be more informative to focus on the dusts generated with the Perra pulvimeter, as the dustiness causes might not be hidden any longer among the bulk properties.

Characterization of the Perra Dusts

The dusts generated and collected with the Perra pulvimeter from selected alumina samples were analyzed for their particle size distribution with an Electric Sensing Zone Analyzer. A fair correlation can be found between the median size of the dusts and the dustiness index of the bulk material, as shown in Figure 9. An even better correlation can be estab-

lished with the % - 20 μm size fraction present in the dust itself (Figure 9). Correlations can be dramatically different. A "clean" alumina, that is an alumina with a dustiness index close to 0.5 kg/ton, generates dusts made of coarser particles with a cohesive mosaic type structure. The dust from a dustier alumina (D.I.= 1.2-1.7 kg/ton) consists of smaller single crystals shaped like plates. It appears as if the presence of some surface roughness can help make an alumina less dusty, as previously

Composition analysis by X-ray diffraction (Table II) reveals that the presence of gibbsite tends to yield a dustier alumina, but other factors also seem to have some influence.

A visual study by S.E.M. of the particles making the dusts has led to the most revealing information. As shown in the micrographs (Figure 10), the size and crystal structure of the dust particles can be dramatically different. A "clean" alumina, that is an alumina with a dustiness index close to 0.5 kg/ton, generates dusts made of coarser particles with a cohesive mosaic type structure. The dust from a dustier alumina (D.I.= 1.2-1.7 kg/ton) consists of smaller single crystals shaped like plates. It appears as if the presence of some surface roughness can help make an alumina less dusty, as previously

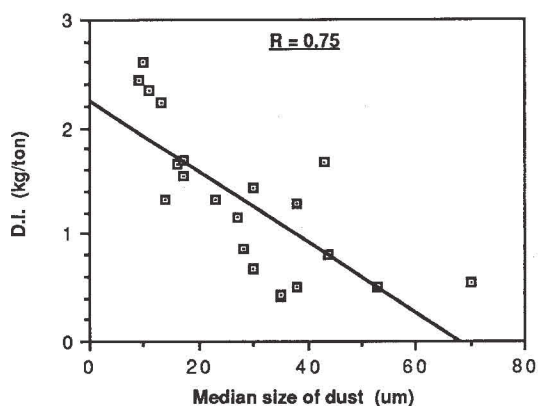

D.I. \approx 0.5 kg/ton

(Plant # 3)

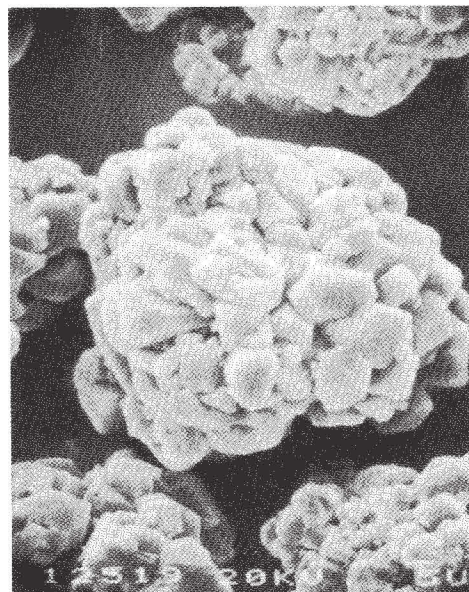
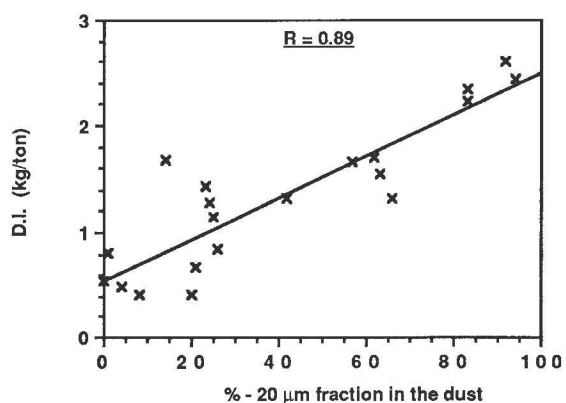

D.I. \approx 1.5 kg/ton

(Plant # 6)

Figure 9. Correlations between the dustiness index of alumina samples and the particle size of the dusts collected with the Perra pulverimeter.

Table II. Dustiness Index of Selected Alumina Samples and Phase Composition of Collected Dusts

Sample	D.I. (kg/ton)	Major component	Avg. component	Minor component
Plant #3	0.41	alpha-alumina		sub-alpha alumina
Plant #7	1.3	alpha-alumina		sub-alpha alumina
Plant #5	1.4	alpha-alumina gibbsite		sub-alpha alumina boehmite
Plant #6	1.6		alpha-alumina sub-alpha alumina gibbsite	
Plant #8	1.7	alpha-alumina		sub-alpha alumina
Plant #9c *	1.7		alpha-alumina sub-alpha alumina gibbsite	
Plant #11 *	3.6, 4.0	alpha-alumina		sub-alpha alumina



* Grab samples; all others, annual composites

Figure 10. S.E.M. micrographs of typical alumina dusts collected with the Perra pulverimeter (2000 X).

noted by Ravn and Windfeldt (8). Their conclusions though were based on S.E.M. micrographs taken from bulk alumina samples - and not from dust particles. A recent study by Wagh and Thompson (9) emphasizes a similar effect and advocates that dry red mud dusts can be reduced by transformation of amorphous content into crystalline material.

Dustiness Index and E.S.P. Dust

Tests were undertaken to understand better the influence of electrostatic precipitator (E.S.P.) dusts on the dusting behavior of aluminas. The blending operation of E.S.P. dust in sandy alumina is not very efficient since both materials behave as if mutually incompatible. The tests described below therefore had to be carried out on less than perfectly homogeneous materials. Moreover, alumina samples from plants #6 and 9 may have already contained some E.S.P. dust.

Uncalcined E.S.P. dust was added in increasing amounts to three aluminas with very different original dustiness behavior. As shown in Table III, a dramatic effect is observed when 1 % E.S.P. dust is mixed with plant #3 sample, but no further significant increase in dustiness index can be seen for larger E.S.P. dust concentrations. Dispersion of E.S.P. dust in this sample caused agglomeration of the dust, more so in this case than with the other alumina samples tested. Two samples, originating from the same plant (Plant #4), were tested later on - one having been sampled at the cool end of the calciner (Sample A: no E.S.P. dust), the other sample taken from the silos (Sample B: with E.S.P. dust). Again, a dramatic increase in dustiness index, from < 0.1 kg/ton for Sample A to 3.8 kg/ton for Sample B, was recorded.

Table III. Effect of the Addition of E.S.P. Dust on Dustiness Index

Sample		Dustiness Index		
		(kg /ton)		
	"as is"	1 %	2 %	5 %
Plant #3	0.41	2.2	2.4	2.1
Plant #6	1.6	1.5	2.2	2.5
Plant #9	2.2	3.1	2.9	3.0

The addition of 1 to 5 % E.S.P. dust shows only a slight increase in dustiness for aluminas with D.I. already well above 1.0 kg/ton. A levelling effect seems also to occur between 2 and 5 % additions. It is also noteworthy to add that more static electricity built-up is observed for aluminas with dustiness indices close to 3 kg/ton (Tables II and III), thus causing some handling problems as particles show strong repulsions within the product itself or tend to stick to container walls.

S.E.M. micrographs of the E.S.P. dust used in these tests (Figure 11) indicate a lack of surface roughness, the particles showing very smooth surfaces. The addition of E.S.P. dust and its effect on the dustiness index can then be correlated with the presence of small crystal plates or smooth spheres. Arguments are now lining up to link handling dustiness with the macroscopic crystal structure of the dust particles.

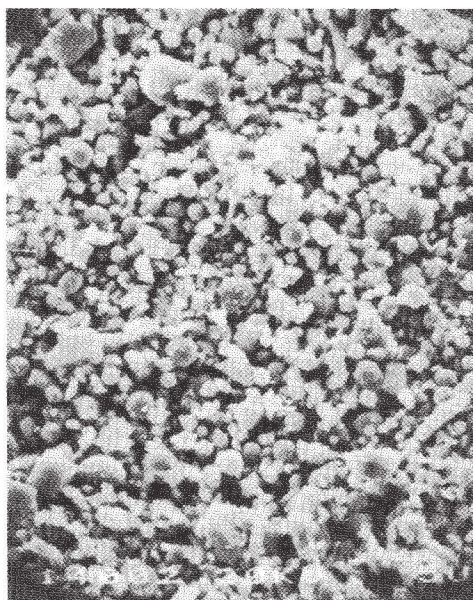

Figure 11. S.E.M. micrograph of uncalcined E.S.P. dust (2000 X).

CONCLUSIONS

Alumina dustiness has been a major concern within the aluminum industry for nearly three decades, but the lack of a reliable and reproducible means to measure handling dustiness has hampered any attempt for a systematic approach.

The Perra pulvimeter was tested on samples from 13 alumina plants over a two-year period. The measurement technique was shown to be simple, fast, reproducible and accurate - and by accurate we mean that the dustmeter gives a reliable picture of the problems experienced in smelters.

Quite a few generally accepted ideas, such as dustiness linked to particle size distribution or fragility, have been shattered by an attempt to correlate dustiness indices with alumina bulk properties. Broad trends were observed, and it even appears as if weaker (fragile) aluminas can be less dusty. But these observations did not help understand clearly what makes an alumina dusty when handled. Analysis of the dusts generated with the Perra pulvimeter has revealed that dustiness is related to the particle size distribution of the dust itself and partly to the presence of gibbsite. The addition of E.S.P. dust to a clean alumina showed a major increase in dustiness index. The S.E.M. micrographs of alumina dusts and of E.S.P. dust tend to correlate dusting behavior with the lack of surface roughness and a plate-like structure of the dust particles.

Overall, progress has been made towards a comprehensive understanding of what handling dustiness is not. Dustiness is not related to the particle size distribution, the loss of mass, the alpha-alumina content or the specific surface area of the bulk material. The correlations found with the attrition index or the bulk density are puzzling at best. We

feel that the shape of the dust particles is the critical factor in handling dustiness. There still lies undoubtedly some questions. We hope that our understanding of handling dustiness of sandy aluminas will be improved as the Perra pulverimeter is slowly introduced in smelter plants, leading to a sustained and systematic gathering of data and observations.

ACKNOWLEDGEMENTS

The author is grateful to Mr. Tony Archer (Alcan International, Kingston R&D Centre) who kindly shared with her his long and rich expertise on alumina behavior.

REFERENCES

1. Threshold Limit Values and Biological Exposure Indices for 1987-1988 American Conference of Governmental Industrial Hygienists, Appendix F, 47-48 and Appendix D, 46.
2. S. Perra, "Measurement of Sandy Alumina Dustiness", AIME Light Metals (1984) 269-286.
3. Standard Test Method for Index of Dustiness of Coal and Coke, ASTM D 547 - 41 (Reapproved 1980).
4. H.P. Hsieh, "Measurement of Flowability and Dustiness of Alumina", AIME Light Metals (1987) 139-149.
5. A. Lalancette, private communication, Alcan Smelters and Chemicals, 8 January 1985.
6. W.L. Forsythe Jr., W.R. Hertwig, "Attrition Characteristics of Fluid Cracking Catalysts - Laboratory Studies", Ind. and Eng. Chem., 41 (1949) 1200-1206.
7. C.K. Matocha Sr., J.H. Crooks, "Improvements and Standardization of Attrition Index Test", AIME Light Metals (1987) 875-879.
8. P. Ravn and A. Windfeldt, "Dusting Properties of Industrial Aluminas", AIME Light Metals, 2 (1975) 237-252.
9. A.S. Wagh, B. Thompson, "A Study of Inter-particle Bonds in Dry Bauxite Waste Resulting in Atmospheric Aerosols", Physica Scripta, 37 (1988) 305-309.