

SOLAR DRYING OF RED MUD

John L. Chandler

Alcan Jamaica Company

Mandeville, Jamaica

West Indies

Solar drying of thickened red mud is the latest method for its disposal in an economical and environmentally acceptable way. Two years full scale experience with this method in Jamaica has shown that its success depends on accurate grading of the solar drying area and accurate control of the pre-dewatering of the mud in the alumina plant. Experience with the use of deep thickening for pre-dewatering is described, together with a novel method for measurement and control of thickened mud rheology.

INTRODUCTIONStacking

Disposal of mineral wastes by stacking has been known for several years. In 1975, Robinsky [1, 2] published an account of what he called the "Thickened Tailings Discharge Method" which he conceived in 1965 and first put into operation in 1973 at the Kidd Creek (zinc) Mine of Texasgulf Canada Limited at Timmins, Ontario. In 1975 also, Haerter [3] published an account of a "Dry Stacking" operation already in use for disposal of red mud at the Gebruder Giuliani alumina plant at Ludwigshafen in Germany.

Stacking of a mineral waste, beside providing a means of separating rainfall from the waste pile, also enables a greater volume of waste to be disposed of on a given area because the top of the pile can be higher than the surrounding dykes.

Stacking & Drying

Where tonnage of mud to be disposed of is small, there is no great problem in disposal in the form of a hard, almost dry material (very like the bauxite from which it came, if it is Jamaican bauxite). Where, however, the tonnage is large and/or the particle size is very small (so that the mud from the plant inevitably has a relatively large water content), the drying of the mud needs to be optimized to avoid using excessively large disposal areas. Large disposal areas are undesirable not only from the environmental point of view, but also from the economic point of view. Rainwater volume collected by a large area and returned to the plant is correspondingly excessive and puts a heavy load on the evaporators.

The local natural evaporation rate needs to be high for economic stacking and drying disposal, but it need not be higher than rainfall rate. The method to be described provides for separation of rainfall so that it does not seriously affect the overall natural evaporation rate.

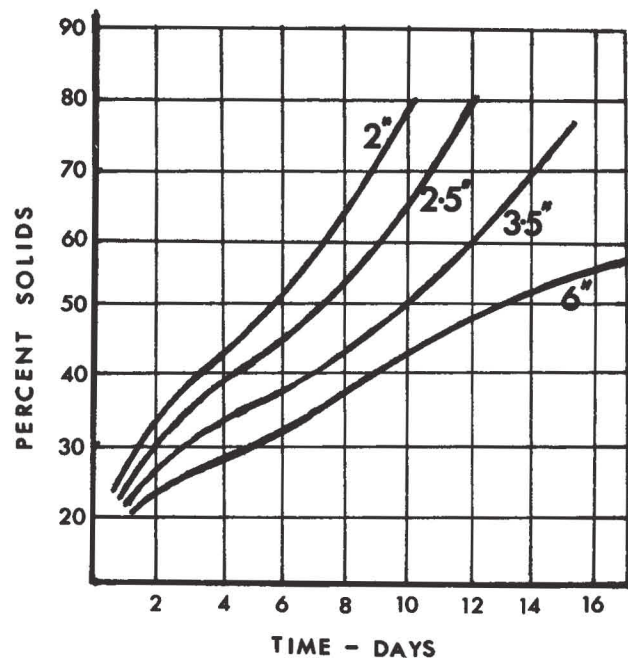

Fig. 1 Drying curves for Jamaican red mud layers of different thicknesses.

SOLAR DRYING

Early small-scale experiments at ALCAN's Kirkvine Works showed that, provided certain design features were observed, deep-thickened red mud could be solar-dried, even in climates where (as in Jamaica) rainfall equals or exceeds evaporation. This is possible because the slope of the stack is sufficient to rapidly separate rainfall from the mud surface, thereby allowing the stack to dry at a rate approximately equal to the evaporation rate from a free water surface. Furthermore, it was shown that dried mud had a granular structure which resisted any appreciable tendency to re-slurry when wetted.

The most important design feature for success with solar drying is that the thickened mud layer exposed to the sun should be limited to a depth of a few inches. As the depth of the layer increases beyond four inches (10 cm) the drying rate falls off rapidly, whereas for layers less than four inches the drying rate is fairly constant and depends only on the climatic conditions. Fig. 1 shows drying curves for various layer thicknesses. The curves for 2", 2.5" and 3.5" actually represent equal evaporation rates, as the longer drying time for the thicker layers is accounted for by the greater water mass in them. Limitation of the layer depth precludes the use of completely flat land on which to dry the mud. Pumping the thickened mud to any point of a flat area results in the mud layer being much deeper near the point of discharge than it is further away. If, however, the mud is discharged onto a slope which has an angle equal to the natural angle of repose of the mud, it flows down the slope maintaining a layer thickness which is constant and depends only on the consistency of the thickened mud. The whole layer then dries uniformly, and reaches 75% solids (25% moisture) in 15-20 days in Jamaican climatic conditions.

Fig. 2 shows elevation and plan views of the conceptual design for a mud stacking and drying operation.

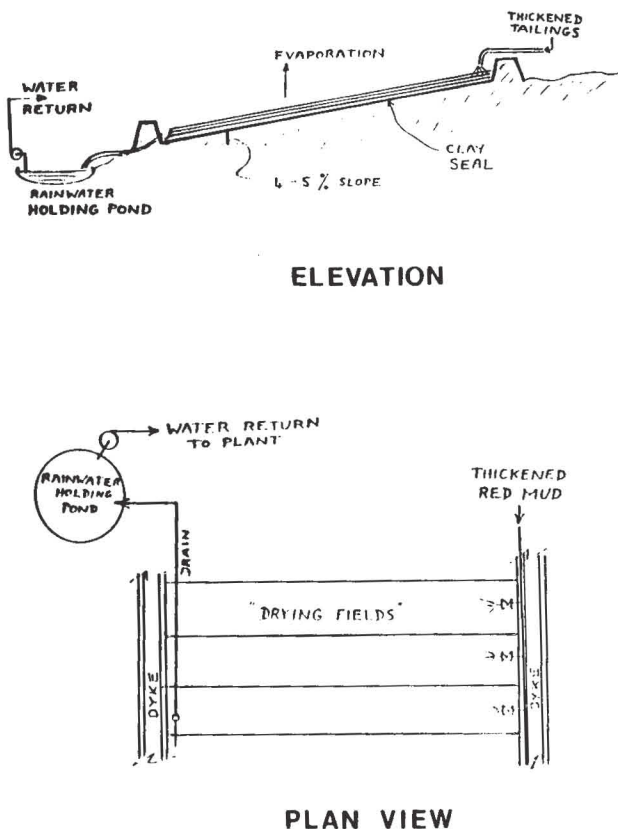

Fig. 2 Elevation and plan views of a typical Stacking and Drying operation.

Drying from the original 23-25% solids (as it emerges from the deep thickeners) to 75% solids results in a dramatic volume shrinkage, and this makes it possible to dispose of a given tonnage of mud in a very much smaller volume than is possible with the "wet" disposal method, or even a "stacking" method which does not include deliberate solar drying. There is no need to dry to beyond 75% solids because there is no further shrinkage or change in mechanical properties beyond this point. Fig. 3 shows the extent of this shrinkage when mud is dried from 23% solids.

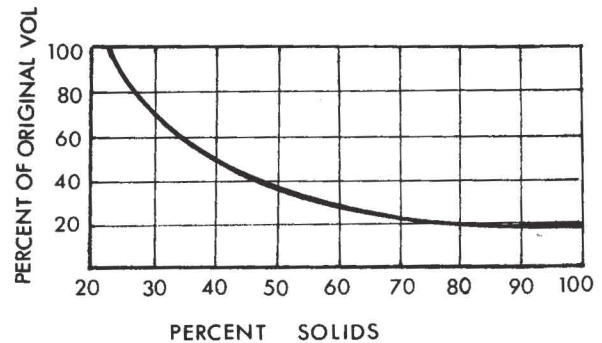

Fig. 3 Shrinkage curve for red mud drying from 23% solids.

Drying Behaviour

As a thin layer of thickened mud dries it first shrinks vertically (i.e. the layer becomes thinner), but soon (at about 35% solids in the case of Jamaican red mud) the horizontal shrinkage causes forces which exceed the tensile strength of the mud layer and a pattern of cracks develops in the layer. As drying proceeds further, these cracks widen and become more numerous; consequently the mud "islands" surrounded by the cracks become smaller and more numerous. When the moisture content of the mud islands drops to about 25% (by weight) these islands cease to shrink and further drying can occur only by evaporation of liquid from the pores of the solid mass and replacement by air.

Jamaican red mud which has been dried to 75% solids or more behaves very differently from clays (of similar particle size) of the same moisture content when subjected to wetting. Dry clay usually swells, disintegrates, and forms a slurry when wetted, but dried Jamaican red mud is physically practically unaffected by wetting. Solutes within the mud mass diffuse out fairly rapidly into the surrounding water but the solid remains intact unless a lot of energy is put into disintegrating it. It is this property that enables the dried mud layer on the stacking and drying site to remain intact even when subjected to heavy rainfall. The resistance to re-slurrying of the drying mud increases continuously as the solids content increases from the initial 25% to the final 75%. Rain falling on the freshly deposited mud (25%) does reslurry a small proportion of it, but this reslurrying effect become negligible after the mud has been drying for a day or two. The leaching of solutes (mainly sodium carbonate) from the drying mud is more serious as it makes rainwater

unfit for domestic or even irrigation use; consequently it is important to collect all the rainwater run-off from the drying site and return it to the alumina plant. This is the reason for the "holding pond" shown in Fig. 2. (In the case of Alcan's stacking and drying site at the Ewarton Alumina Plant, the holding pond is 22 acres in area, and its volume is sufficient to store all the water which is likely to fall on the area in a rainy season, so that it can be fed into the plant at a uniform rate as wash water.)

Pretreatment of the Red Mud

The red mud leaving an alumina plant is normally in the form of a slurry which is too dilute and too fluid to "stack" on a sloping surface. It has to be thickened by removing about half the water before it can be pumped to a stacking (with or without solar drying) area. Red muds from bauxites other than Jamaican bauxites, can be filtered to remove this water, but Jamaican red mud is extremely fine and consequently filters very slowly. Another method of thickening the mud had to be found and the solution was found in the development of "Deep Thickening" technology.

Deep thickening is a relatively new slurry thickening technology which fills the gap between conventional thickeners (including "high rate" thickeners) and vacuum filters. As such, it produces a slurry which is more fluid than the cake produced by vacuum filters, yet less fluid than that produced as underflow by shallow, large diameter, thickeners. This relationship is shown in Fig. 4, which is a correlation between the "rigidity" (or fluidity) of the output of thickeners and de-waterers and the pressure used to effect the separation of solid from liquid therein.

Basically, deep thickening is a sedimentation and compaction process which differs from conventional sedimentation in that it uses very deep beds of mud slurry. Water is squeezed out of the mud at the bottom of the bed by the compression exerted by the weight of the mud above. Fig. 5 depicts the difference in geometry between "conventional" and "deep" thickeners. Detailed description of deep thickening is beyond the scope of this paper, and can be found in references [4, 5]. A set of four deep thickeners was installed at Alcan's Ewarton Works, prior to the construction of the stacking and drying area already described, and these four are capable of thickening all of the red mud effluent from the plant to the thickness (or consistency) at which it can be stacked and solar dried.

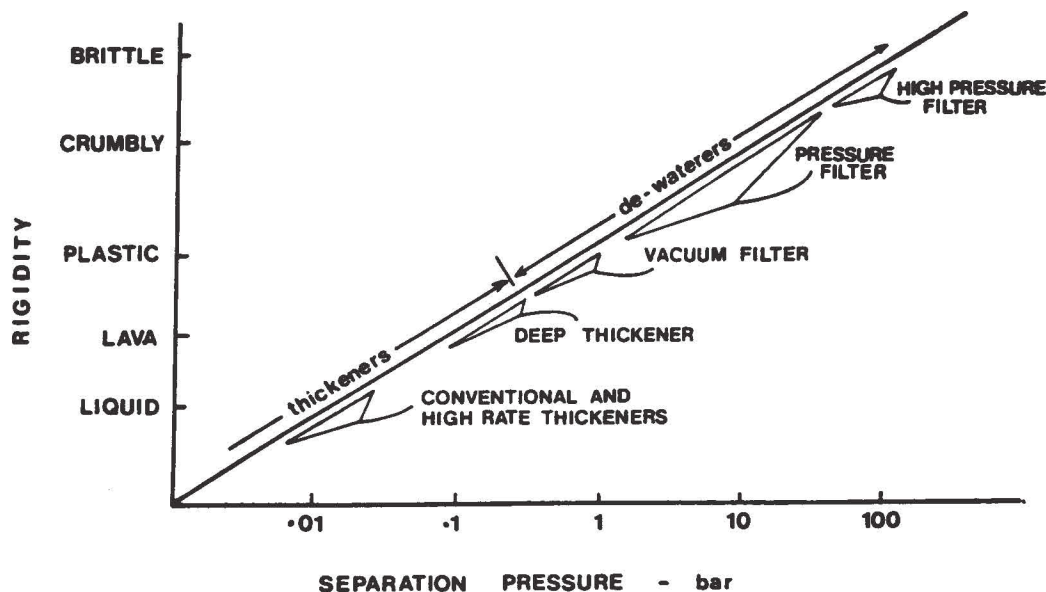

Fig. 4 Dependence of fluidity of red mud on pressure applied in its separation from liquid.

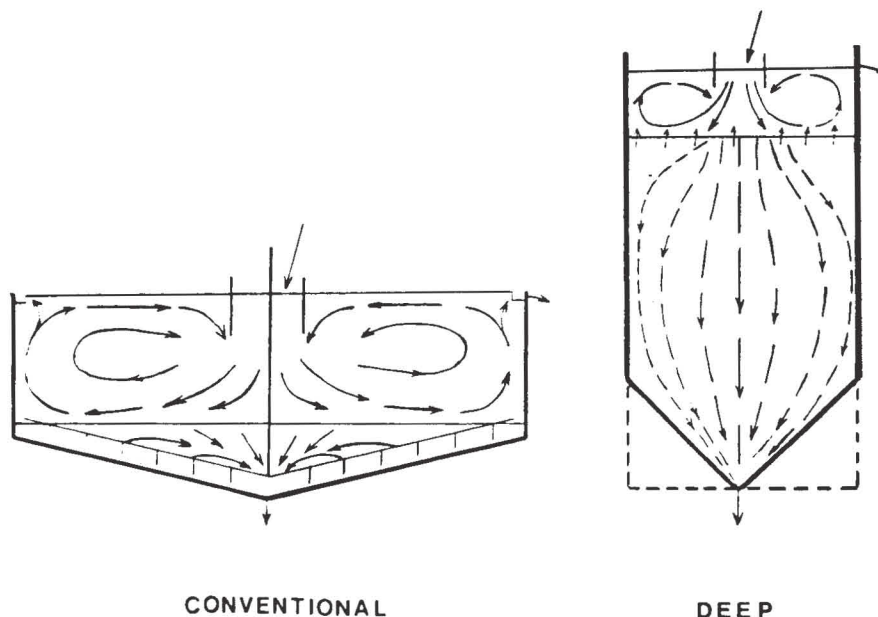

Fig. 5 Comparison of the geometry of "conventional" and "deep" thickeners, showing internal flow patterns.

Rheology of Thickened Red Mud

The rheology of red mud, which has been specially thickened to be suitable for the stacking and drying process, has a marked influence on the way it behaves both in pumping to the disposal site and in spreading on the sloped site.

Thickened red mud, from all alumina plants regardless of the bauxite source, behaves as a Bingham plastic material. The flow characteristics are summarized by the typical shear-stress vs. rate-of-shear graph shown in Fig. 6. As the shear stress (produced by the pump if we are considering a pump and pipeline system) increases there is no flow at all until the yield stress (see Fig. 6) is exceeded. Flow then starts, and, because of the flatness of the curve from here to the transition point, the velocity increases enormously for a slight increase in applied pressure. Over this range the flow is laminar. A further increase of pressure and flow velocity takes the flow past the transition point into the turbulent region where pressure needed increases rapidly in relationship to velocity achieved.

In the interest of power economy, it pays to keep the pipeline velocity below the transition point, i.e. in the laminar region. This principle is a departure from customary slurry transport practice, which is to keep the flow well in the turbulent region so as to prevent large or dense particles from settling in the pipeline. This energy-consuming precaution is not necessary in thick mud pumping, as the yield stress of the mud is high enough to prevent particles settling to the bottom of the pipeline.

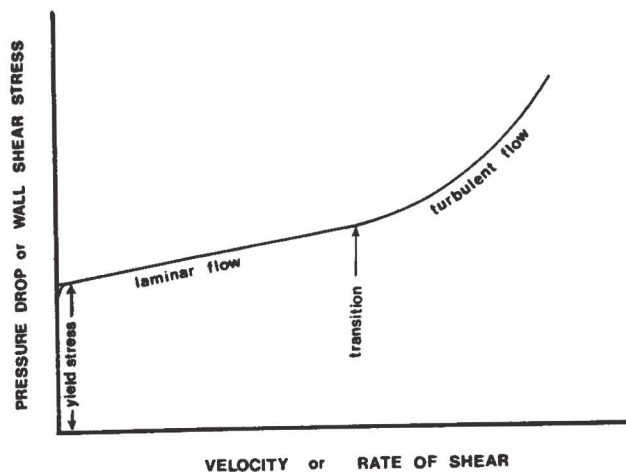
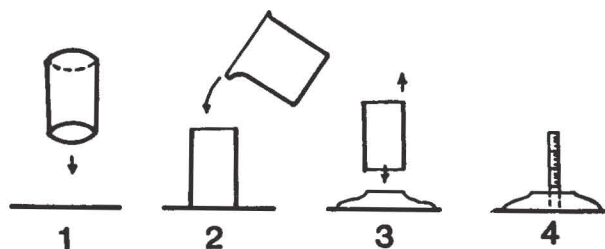

Fig. 6 Rheology of red mud thick enough to stack.

Control of Mud Consistency

The importance of accurately controlling the depth of the mud layer on the sloping drying surface has already been stressed. Obviously a method of monitoring the consistency of the mud coming from the deep thickeners is essential, and a method had to be devised because it was demonstrated that the solids concentration was not a reliable parameter for control. Slight variations in the particle size or shape of the mud solids caused wide variations in the fluidity of the mud slurry even when the solids concentration was held constant. A simple test known as the "slump test" has now been in use for several years for monitoring the mud consistency, and it has been found to correlate very well with the behaviour of mud on the stacking and drying site. The stages of the test are depicted in Fig. 7. A cylinder 4 inches diameter by 5 inches high (10 cm by 12.5 cm high) is made by neatly cutting out the top and bottom from a 1 litre (or 1 US quart) lubricating oil can. The can is then held down tightly on to a rubber pad of 12 inches (30.5 cm) diameter. The cylinder is then slightly over-filled with mud and the surplus is scraped off with a straight-edge. The cylinder is then lifted off slowly and the mud flows out of the open bottom to form a more-or-less conical pile on the rubber pad. The height of the pile (or "slump") at its centre is recorded as the "slump height". For mud to spread as a 2.5 to 3.5 inch layer (6.3 to 8.9 cm) on a 4.5% slope, as used at the Ewarton drying site, the slump height has to be 1.2 inches (3.0 cm). Other slopes need correspondingly higher or lower slump values to maintain this ideal layer thickness, but the relationship between slump and slope has not yet been determined over a wide range of slopes.



ALCAN'S "SLUMP TEST"

Fig. 7 The four steps of the ALCAN Slump Test for stackability of red mud.

Field Experience

Mud Stacking and Drying has been practiced in Jamaica for the past two years at a site close to the Ewarton alumina plant.

The area used is 205 acres (83 hectares) divided by dykes into four zones each of approximately 50 acres (20 hectares). Fig. 8 shows the arrangement of the zones and the drying fields within these zones. The irregular shaping is due to the natural topography of the area. Commissioning of the zones was as follows:-

Zone 1	May 1985
Zone 2	Feb 1986
Zone 3	Feb 1987
Zone 4	July 1987

As each zone was commissioned it became possible to feed a higher proportion of the plant's output of mud to the drying area and correspondingly less to the conventional wet storage pond. By August 1987 all of the mud (950 tonnes/day, dry basis, at average 23.5% solids, = 4042 tonnes/day slurry) was being stacked and dried, except for infrequent short periods when continuous rain precluded any drying.

The following mass balance reflects current (Aug 1987) average operation of the stacking and drying area:-

	<u>Water t/day</u>	<u>Dry Solids t/day</u>
Plant output of mud	3092	950
Mud stacked and dried (95%)	2937	902
Dried mud produced (75% solids)	300	902

Water evaporated	2637	

2637 tonnes/day evaporation on 74.7 hectares (90% of available area) equals average evaporation rate of 3.53 mm/day. This compares with a pan evaporation rate of 5 mm/day averaged over the first six months of 1987.

Evaporation rate from the drying mud layer would not be expected to exactly equal pan evaporation rate. In the first few days, when the liquid film on top of the mud is continuous, evaporation rate would be expected to exceed the pan rate because surface temperature would exceed that of the surface in a pan, while later in the drying cycle, when the liquid/air interface recedes

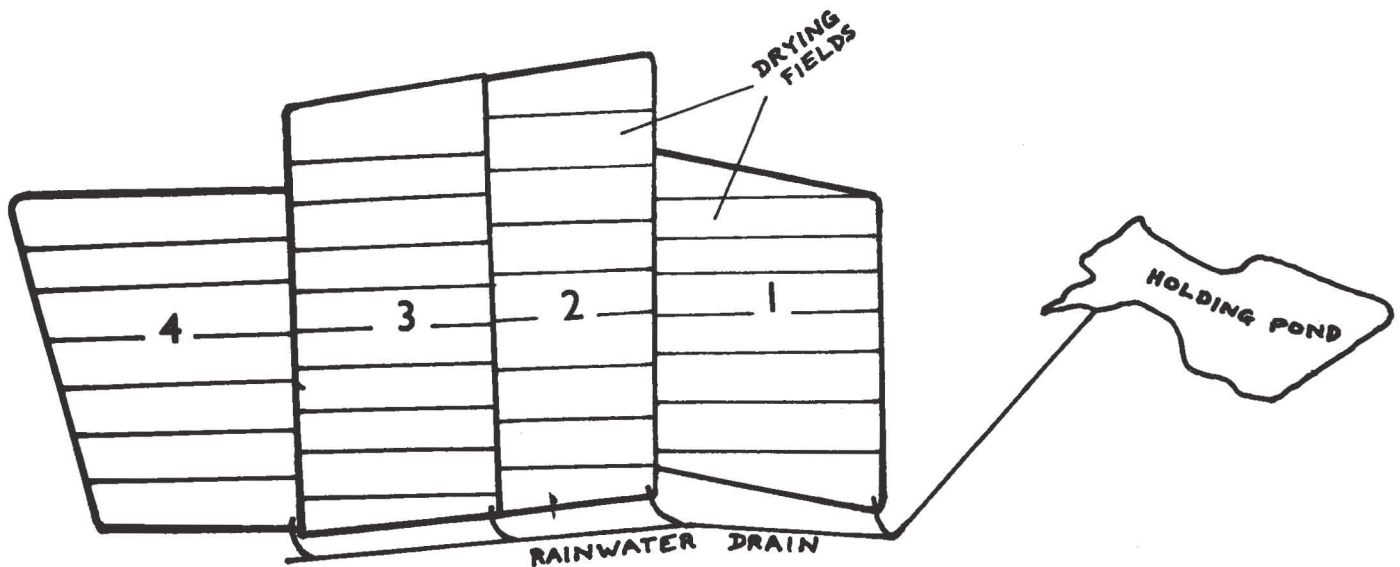

Fig. 8 Plan view of new Stacking and Drying Area at Alcan's Ewarton alumina plant.

REFERENCES

into the mud mass, the drying rate would be lower than pan rate. (Experiments under controlled conditions showed that evaporation rate is constant from 25% to 50% solids but dropped to half this rate between 60% and 70% solids). In the same way that a factor has to be applied to a pan evaporation rate when it is used to predict open water rate, so a factor is needed to predict mud drying rates. From the first two years experience, our best estimate of this factor is 0.70 (from $\frac{3.5 \text{ mm}}{5.0 \text{ mm}}$)

This, coincidentally, is equal to the factor usually used for conversion from pan to lake (open water) evaporation [6].

1. E.I. Robinsky, Bull. Canadian Inst. Min. and Met. 68 (Dec. 1975), 47.
2. E.I. Robinsky, 11th A.I.M.E. Annual Meeting, Dallas, Texas (1982), Light Metals, (Metall. Soc. of A.I.M.E., Warrendale, Pa, 1982), 239-248.
3. M. Haerter and B. Scheffers, Proc. of 9th International Manifestation of ICSOBA, Oct. 1975, Dubrownik, Yugoslavia.
4. J.L. Chandler, I. Chem. E. Symposium Series 45 Inst. of Chem. Engrs., Rugby, U.K. (1976).
5. J.L. Chandler, World Filtration Congress III, (Uplands Press Ltd., Croydon CR9 1LB England, 1982), 372-379.
6. H.E. Babbitt et al, Water Supply Engineering, 6th Ed, (New York, N.Y., U.S.A., McGraw Hill), 84.