

## REDUCTION OF HF EMISSIONS FROM THE TRIMET ALUMINUM SMELTER (OPTIMIZING DRY SCRUBBER OPERATIONS AND ITS IMPACT ON PROCESS OPERATIONS)

Martin Iffert<sup>1</sup>, Markus Kuenkel<sup>1</sup>, Maria Skyllas-Kazacos<sup>2</sup>, Barry Welch<sup>2</sup>

<sup>1</sup>TRIMET ALUMINIUM AG, Aluminiumallee 1, Essen D-45356 Germany

<sup>2</sup>Centre for Electrochemistry and Mineral Processing, University of New South Wales, Sydney 2052, Australia

Keywords: Dry Scrubber, HF Adsorption, HF Generation, HF Management, Bath Chemistry

### Abstract

Aluminum smelters worldwide are challenged by increasing ecological and economical pressure. Higher line amperages gain production output but increase the HF load on dry scrubbers. Another important factor today is the tight alumina market, hence it is necessary to accommodate dry scrubber and potline operations to different alumina sources and qualities regarding their HF generation and scrubbing efficiency as well as its impact on bath chemistry. The TRIMET smelter optimized dry scrubber operations by the use of a laser based HF measuring system in each of the 20 filter modules. Based on the HF level in the outlet of each filter the alumina flow to each filter is pulse-duration modulated, thus tightly control the HF emission level in the outlet gas. This paper describes the application of the new measuring and control principle and its impact on HF scrubbing efficiency and bath chemistry.

### Company Information

TRIMET ALUMINIUM operates the only non-integrated and, therefore, independent primary aluminum reduction in Europe. In 3 potrooms with 120 Hall-Héroult cells each, and with a 3-shift operation the smelter produces approximately 155,000 tons of primary aluminum per year. Although the smelter mainly serves the own casthouse, some liquid metal is also supplied to local customers. The TRIMET Smelter in Essen was commissioned between 1971 and 1973. The potlines are Alusuisse technology end-to-end with prebaked anodes, originally built for 140 kA (EPT 14). After a major modernization in 1986 the cells were equipped with point feeders and individual pot controllers. Currently, the line amperages are 158 kA in line 1 and 2 and 165 kA in line 3 (EPT 17 since 1998). Line 3 was modernized in 1998 with a new busbar system and modified pot shell structure. Current efficiencies above 94 % and energy consumptions below 14.0 kWh per kg aluminum over the last 2 years mark new record levels in the history of the plant [8]. Today the annual casthouse production amounts up to 230,000 mt. This figure will increase in future time by upgrading the casthouse facilities, which is currently an ongoing process. The melting furnaces will increase the melting capacity from 3 mt/h to 8 mt/h. Thus giving the opportunity to serve the market even better while increasing the rate of remelted scrap. The products are high quality slabs and billets for extrusion, forging and rolling purposes, as well as slabs for steel coating. This spectrum demand approximately 100 different dimensions and 450 different alloys including bright shining qualities and special qualities per customer request. Initial products for the fabrication of safety parts for the automotive industry are an important objective. They are inspected on the world's most sophisticated ultrasonic testing unit with zero-fault guarantee before being delivered to customers.



Figure 1: Superheat Measurement in Reduction Cells

### Introduction

Today all modern smelters operate state-of-the-art dry scrubbers. Over the last two decades this process has been proven to be ecologically and economically successful. The need for higher acid bath and increased current intensity give higher fluoride load to the dry scrubber [6]. The efficiency of this process is related to the HF level in the raw gas, contact time between gas and alumina, specific surface area (SSA) of alumina and kinetic behavior of this alumina. In this respect there are two counteracting properties in the alumina that influence the generation and adsorption of HF. Higher SSA is achieved by lowering the calcination temperature, this can improve the adsorption capacity and hence lead to lower emissions from the stack. On the other hand the lower calcination temperature leads to increased levels of crystal water, which can be seen in the LOI. The crystal water again is the main source for HF generation [1].

TRIMET developed a complex system to measure, control and visualize the dry scrubbing process in detail. The key element in this control system is a 20-channel laser based HF measurement device. This enables us to manage the higher HF raw gas levels even with quite different types of alumina. Furthermore it was possible to extend the number of high purity pots due to less alumina consumption in the gas treatment center.

### TRIMET's Dry Scrubber

TRIMET operates one central dry scrubber to treat the fumes from all of the 360 pots. The aluminum duct system has a total length of about 8 km and connects all pots in the 3 potrooms with the dry scrubber. The duct system has a pressure drop of approximately 15 – 20 mbar while the off-gas temperature drops about 20 – 40 °C

on the way from the pot to the gas treatment center. The dry scrubber was built and designed in 1985 by Procedair (today Solios) and consists of 20 filter modules, two fresh (primary) and two enriched (secondary) alumina silos, alumina air slides as well as alumina distribution systems. Each filter module contains the venturi styled reactor, the bag-house, the main fan as well as the counterblow cleaning system. The total volume flow is 1,800,000 m<sup>3</sup>/h with a design HF raw gas concentration of 120 mg/m<sup>3</sup>.

In 2002 and 2003 it became more and more difficult to control the HF levels in the exhaust gas due to higher raw gas HF concentrations and the need to use different alumina qualities in short intervals. The alumina types differentiated in their HF generation and adsorption abilities. The alumina influenced HF generation is mainly controlled by the crystal water content (LOI, Loss On Ignition tested in the temperature range 300 °C – 1100 °C) in the alumina. Hyland et al describes this behavior in detail [1]. The adsorption capacity on the other hand is strongly related to the SSA of the alumina (typical 70 m<sup>2</sup>/g), but also influenced by kinetic effects, which control the transport of the gas into the microstructure of the alumina grain.

Dry scrubber performance is characterized by HF scrubbing efficiency, volume flow and pressure drop of the dry scrubber. In the Essen installation all 20-filter modules are connected in parallel. Hence the total efficiency is a consequence of the individual efficiencies. Volume flow and pressure drop are linked like voltage and current in an electrical network. Therefore it is possible to apply the same equivalent networks and rules to describe the operation. Filter bags, damper and ducts act like resistances while chimney and main fans are the “voltage” sources. The target for this kind of operation is achieving an equal flow rate in each of the filter modules. Assuming that the fans create an equal and consistent suction performance, the flow rate will be determined by the filter resistance and the damper position. Herein filter resistance is controlled through the counter flow cleaning cycle frequency and duration, thus influencing the filter cake thickness. Beside the negative effect of increasing the filter resistance, the filter cake thickness is very important for the HF cleaning efficiency as well as working as the last dust collection barrier.

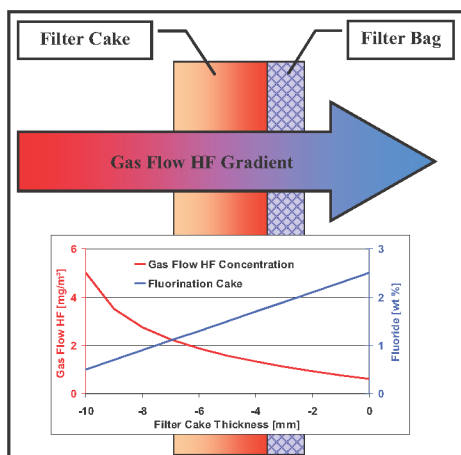

Figure 2: Filter Cake Principal

HF scrubbing efficiency in this kind of injection system has two zones where the fluoride is transferred onto the surface of the alumina grains. The first zone is the injection zone where fresh

and enriched aluminas are injected into the gas stream. The second zone is the filter cake.

Very important factors in achieving a good scrubbing efficiency are the gas-alumina contact time and the gas-alumina mixing quality. Therefore it is important to get a good, equal mixing in the injection zone where the relative velocity between gas and alumina particles is high. As soon as particles and gas are moving with the same velocity, the HF scrubbing efficiency drops down because of an HF concentration gradient around the alumina grains. Nevertheless 95 % of the HF is cleaned out of the gas stream on the way from the reactor zone to the filter area (6-9m).

The remaining 5 % are scrubbed at the filter cake. The efficiency of the filter cake is increasing with growing thickness of the filter cake and shrinking gas flow velocity through the filter fabric. The growing filter cake will increase the filter resistance and hence the filter pressure drop, as a consequence the flow rate through the filter will drop. To keep the flow rate close to constant, the filter cake is regularly blown off by using the counter flow cleaning system. During years of operation the filter bags experience a kind of ageing effect due to fine particles entering into the microstructure of the filter fabric and scaling coating the surface of the filter bag. Therefore the lifetime of filter bags is limited to 4 – 6 years.

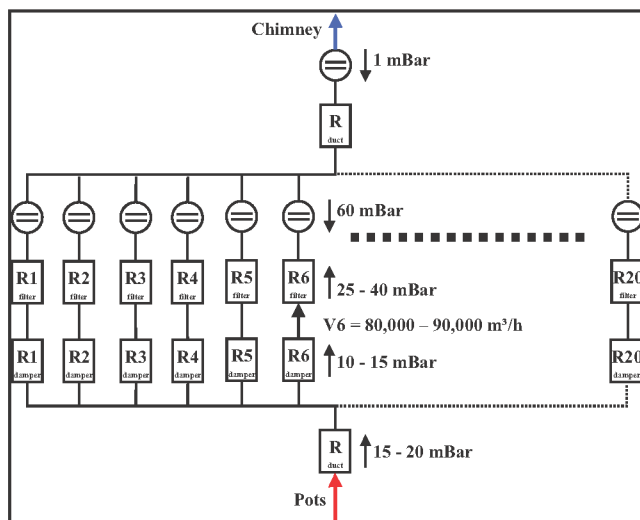

Figure 3: Parallel connected Network of Filter Units

Balancing the network of 20 parallel-connected filter units is a difficult challenge, but necessary to achieve equal flow rates in all filter modules. Besides the cleaning cycle and cleaning pulse time, which has an influence on the filter resistance, there is a manual adjustable damper. The damper can be used to compensate the raising filter resistances with increasing filter age. Nevertheless it is a difficult challenge to adjust the flow network, because a change in one leg of the parallel-connected flow network influences all other flow rates. Therefore it is very helpful to have online measurements of all 20-flow rates. This helps to adjust the damper positions and the cleaning cycle set points.

While adjusting the flow rates it is important to do this according to the off gas temperature. The scrubber has a special temperature vs. nominal flow characteristic. Figure 4 shows this relation for the current operating window. It can be seen, that the nominal flow rate in 2004 was between 1.4 Mil Nm<sup>3</sup> - 1.7 Mil Nm<sup>3</sup>, while the temperature swung in the range 90 °C – 57 °C.

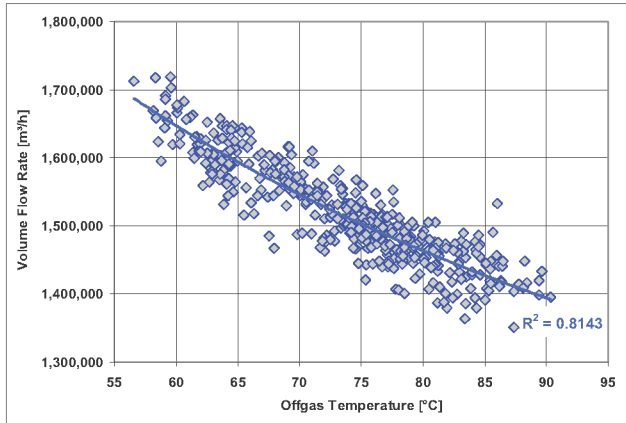

Figure 4: Relation btw. Nominal Flow Rate vs. Temperature

### Development Of Scrubber Performance

This work, improving dry scrubber operations, was started in 2002 and involved basically 4 steps as described below:

1. Evaluate actual situation (Autumn 2002)
2. Improve maintenance status of the dry scrubber
3. Develop and install new control concept
4. Review success

After 10 years of low maintenance the performance of the dry scrubber was at a low limit. Reason for this was the shut down of the smelter in 1992 and 1993, with a start-up of only 65% of the production in 1994 under new ownership. In the following years the dry scrubber operation was not critical because it was only running at 65 % of the design capacity. Hence it was not in the main focus of engineering and maintenance. During this time only defect filter bags were exchanged, thus leading to big differences in filter bag resistances inside the filter units. As a result the gas velocity at new filter fabrics was too high leading to a faster ageing of the filter bags and consequently an increased filter pressure drop. Due to the absence of online measurements in the filter units this process could not be monitored and was not realized until 2002. The only online measurements (HF, volume flow rate and dust) were taken at the central chimney of the dry scrubber and hence represented an average of all 20-filter units. A special problem regarding the volume flow measurement originates from the turbulent gas flow in the chimney. This led to wrong measurements showing too high flow rates for several years.

After the third potline was taken into operation in 1998 and subsequently the production in all three potlines was increased, the dry scrubber operation became critical. This situation was determined during several measurement campaigns in 2002. In these campaigns it was identified, that the volume flow rate was approximately 15 % below design capacity. Further measurements showed excessive high filter pressure drops and imbalances between individual filter units. Therefore a decision was taken to improve the status of the dry scrubber and to develop a new control concept. The first step in 2003 was a complete change of filter bags. While doing so the filter pressure drops could be reduced from 50 mbar to 30 mbar and subsequently the volume flow rate could be increased. But this was only a first step in improving the gas treatment center to meet the increasing challenges arising from higher production and varying alumina qualities.

HF Measurement campaigns at the outlet of each filter unit using a portable HF laser detector showed big variations in HF concen-

trations at the outlet of each filter. Diagrams 5 and 6 show the results of these campaigns.

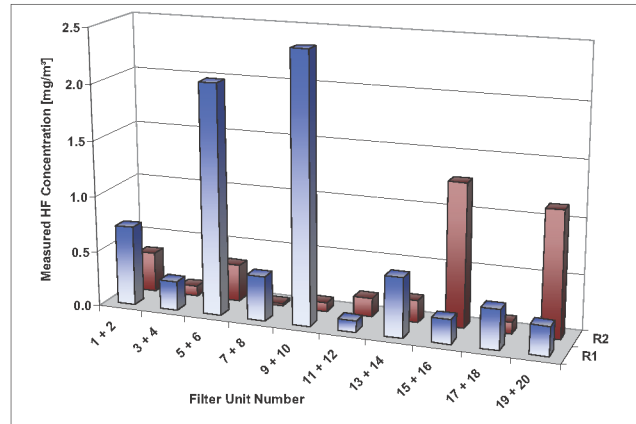

Figure 5: HF Concentrations in Outlet of each Filter

Diagram 5 shows the distribution of HF concentrations throughout the dry scrubber while diagram 6 presents the cumulative HF concentrations and volume flow rates. Here it can be seen that volume flow rates are relatively equal spread (difference of +/- 15%), but there are big differences in the HF mass flow caused by individual filter modules. The worst four filters causes 65 % of the HF emissions while contributing only 22 % to the overall flow rate. This shows that there is an attractive performance gain when reducing the spread in HF emissions from individual filter units.

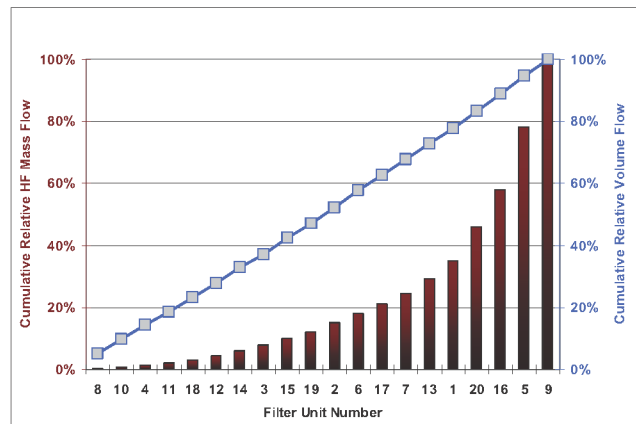

Figure 6: HF & Flow Rate cumulative per Filter Unit

### Pre Studies on HF Influencing Operating Conditions

The influence of different operating parameters on the resulting HF emission level was studied by manipulating fresh and enriched alumina flow, raw gas HF concentration and filter cake thickness. The results of these variations can be seen in figures 7 to 10. This demonstrates that there are several factors having a dramatic influence on the HF scrubbing efficiency. But only a change in primary alumina supply is technically feasible for our operation. Figure 7 shows this experiment. In figure 7 the alumina supply was decreased by 25 % at 5:30 pm. It can be seen that the HF concentration subsequently increased by 50 % from 0.4 mg/m³ to 0.6 mg/m³. This demonstrates the ultimate and direct response of the HF concentration in relation to the fresh alumina supply.



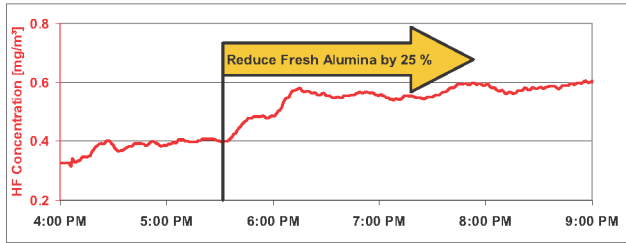

Figure 7: HF vs. Reducing Primary Alumina Supply

The next chart shows the influence of an increased recycled alumina supply. While doing so the alumina will be operated in more cycles through the dry scrubber, producing more fines. The HF concentration in our example (figure 8) decreased from 0.7 to 0.4 mg/m<sup>3</sup> after the supply of enriched alumina was doubled.

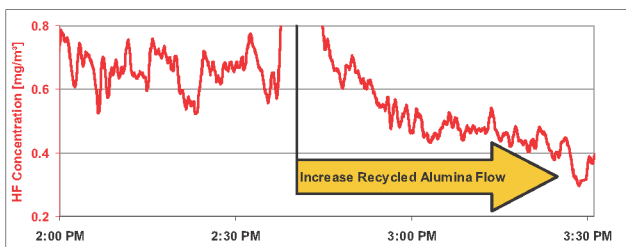

Figure 8: HF vs. Increasing Secondary Alumina Supply

Another manipulation method is related to the filter cake thickness. The average filter cake thickness can be decreased through increased bag cleaning. The smaller filter cake will result in higher HF emissions. This can be seen in the next chart where the cleaning pressure was increased.

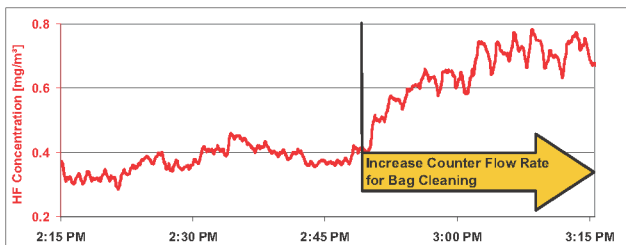

Figure 9: HF vs. Increasing Cleaning Pressure

Figure 9 shows an increase in HF emissions from 0.4 to 0.7 mg/m<sup>3</sup> after the cleaning pressure was increased. This is equivalent to a 0.1 % decrease in cleaning efficiency (99.9% down to 99.8%, with the limit being 99.7%) and demonstrates the importance of the filter cake in mastering the high cleaning targets.

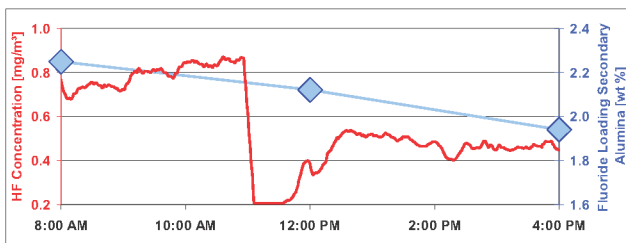

Figure 10: HF vs. Reducing Raw Gas Concentration

The effect of raw gas concentration and saturation levels can be seen in the next chart. The HF level at the output of filter unit 11

went synchronous down after line 2 was shut down. Even after the restart of potline 2, 30 minutes later, the HF level remained on a significant lower level compared to the level prior to the shut down. During the shutdown period the HF raw gas concentration decreased from 350 to 280 mg/m<sup>3</sup>. The response of the filter system to the reduction in HF raw gas concentration can be seen in diagram 10. HF emission levels decreased from 0.8 to 0.2 mg/m<sup>3</sup> as potline 2 was shut down. After the restart the HF level increased gradually back to 0.5 mg/m<sup>3</sup> and stabilized on this level. Reason for this being the increased scrubbing efficiency of the recycled alumina as the fluoride loading decreased from 2.25 wt% to 1.94 wt% (Figure 10).

### HF Measurement Technology

Continuous measurement of HF concentrations using tunable diode laser technology has proven to be efficient and accurate. This measurement technology as described in the literature [9, 10] was also testified by the German TUV and hence became the standard HF measuring technique in the German aluminum smelting industry. All the relevant official HF gas concentrations, which are also reported to the government, are measured with this technology. TRIMET had its first installation of this kind of measurement in 2002 in the central chimney of the dry scrubber.

### Technical Instrument Descriptions

#### Measurement Devices

During the last 20 years technology has evolved and new measurement technologies went into the market. Especially for this kind of application the laser based HF measurement technique could help monitoring HF emissions continuously and accurate. As outlined in this paper it was possible to booster the dry scrubber performance with the help of this technology by more than 10 %. This could be achieved with only a tenth of the cost for additional scrubbing capacity. Furthermore this control system improved our understanding and monitoring of the process. Additional measurements observe the filter pressure drop and the volume flow rate in each filter module. Since the start-up of the dry scrubber the alumina qualities have fundamentally changed. Together with the increased amperage and the more acid bath higher fluoride load is applied to the dry scrubber today. In the TRIMET case, HF raw gas concentrations doubled over the last 20 years from 150 to 300 mg/m<sup>3</sup>. 20 % of the increase can be attributed to the production increase while 80 % are provoked by the change in raw materials and bath chemistry. This implies also that the link between higher surface areas and more crystal water caused a significant increase in HF generation. Nevertheless the minimum adsorbing efficiency is 99.7% while the average is 99.8 - 99.9%. This demonstrates the necessity for a high level of sophistication in this process.

**Pressure Drop.** The filter pressure drop is a consequence of volume flow rate, filter cake thickness, density of the fabric and fabric condition (ageing). To measure the filter pressure drop (DP), plastic tubes are connected to the raw and clean gas side of the filter on one side and to a pressure gage on the other side. The pressure gage delivers a 4-20 mA signal as output, for the range of 0-60 mbar.

**Volume Flow.** The volume flow should be close to target and equally spread over the filter units, which are connected in parallel. A change in one filter unit will influence all other filter units.

This is important information, especially when keeping in mind the relation between HF scrubbing efficiency and filter velocity. The measurement is carried out using a Prandtl tube, which is connected to a pressure gage. This creates a 4-20 mA signal. From the differential pressure drop the gas velocity can be calculated. To transform the results into normal gas flow, the gas temperature is measured as well.

**HF Concentration.** Establishing the HF measuring system was the key issue and the critical path throughout this project. The technology was already well known in Essen from the HF measurement in the chimney. Nevertheless it was economically not feasible to install the same device in all 20-filter units. Therefore together with the Canadian supplier, a new 20 channel multiplexed HF laser measurement device was developed and integrated. The optics were changed to a low budget version as well.

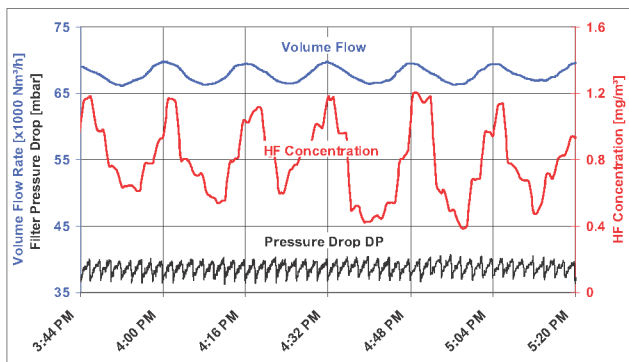

Figure 11: HF, Flow and DP during Cleaning Cycles

From the central measurement device the laser beam is sent out through a rotating prism, which alternately transfers the laser beam to one of the 20 measurement locations via fiber optic cables. The lens sends the laser beam through the gas stream onto a reflecting tape, from there the beam is reflected to the sender-receiver unit. The identified intensity will be reported back to the main unit via coax cables. The main unit translates the signal into a 4-20 mA output signal. All 20 channels are scanned through every two minutes. This means, that each channel is measured 6 seconds before moving on to the next filter unit. For our application this HF measurement frequency is high enough. The other parameters are scanned with a much higher frequency (1 Hz). A sample printout of the volume flow-rate, HF concentration and pressure drop is given in Figure 11.

**Control Devices**

Measuring and monitoring is one part of the process, but even more important are the control devices. These are the counter flow pulsing system and the alumina supply, which can be manipulated online. The filter pressure drop is influenced by the cleaning frequency and duration. During the cleaning time the remaining filter area is reduced and therefore the typical filter availability is reduced by 1 – 3 %. The most important control task is attributed to HF sensing and alumina supply manipulation. Due to the new control concept, HF concentration is not only monitored but also used as a trigger for the additional alumina supply. Herein the injection fresh alumina into the reactor of each filter unit is manipulated. Each reactor has a main alumina supply and a back-up alumina supply. The amount of alumina flowing through the main and the back-up system can be adjusted manually by changing the

diaphragms. This methodology can't be used to react to HF variations online. Nevertheless both dosing systems can be activated and deactivated using existing electrical slides. This functionality is now used to pulse-duration modulate the alumina flow into the designated filter unit in response to the HF concentration.

**PLC Integration of Measuring, Controlling and Monitoring**

The integration of all measuring and controlling actions was done using a Siemens S7 PLC. All measurement signals were transformed into 4-20 mA signals, which were connected to the analog inputs cards of the S7 system. The control actions are calculated and adequate signals are sent to the different valves. A number of different parameters can be adjusted from the operator via the graphical user interface. The visualization is done using the commercial WIZCON system.

**Factors Influencing HF Generation**

The generation of HF is an unavoidable process accompanying the Hall-Heroult aluminum production. Any hydrogen source entering the electrolyte will potentially create hydrogen fluoride. The main sources of HF generation are structural water (alumina) surface water (alumina), hydrogen in carbon and hydrolysis from moisture in the air coming in touch with the bath surface mainly in the area of open holes in the crust. These are described by the reactions given by Equations 1 and 2. Different tests were carried out to distinguish between these HF generating effects.

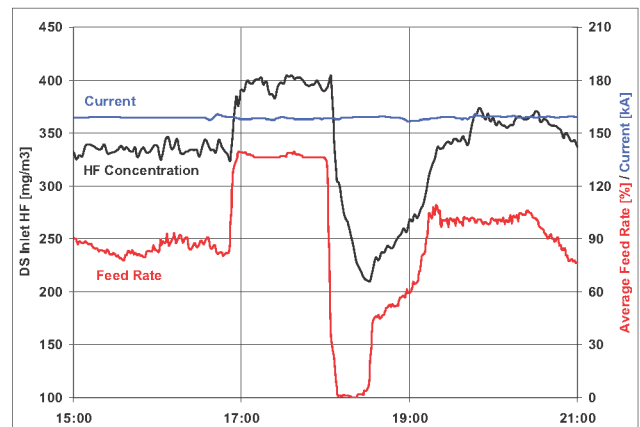
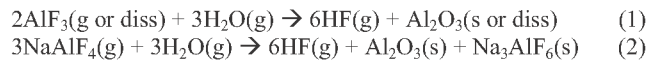

Figure 12: Raw Gas HF vs. Feed Rate and Current Experiment 1

Figures 12 and 13 show two experiments with manipulation of alumina feeding and current. These tests were carried out on half a potline consisting of 60 cells. The offgas HF concentration and hence the observed response to the manipulations was measured in the main duct which carries the gases of exactly those 60 pots. The manipulations on all 60 pots were done simultaneously and consisted of a) normal-feed b) over-feed c) zero-feed d) underfeed e) nominal-current and f) zero-current. As the tests were carried out on a big number of pots simultaneously, the responses are very stable and hence very representative for this pot technology. The results are not influenced from individual crust conditions or special causes on single pots. In experiment 1 only the alumina feed was manipulated, the current stayed constant on the nominal level of 158 kA. The feeding to the 60 pots started at normal level

of about 90 % before all pots were switched to over-feeding mode (140 %) at 16:50. The HF concentration increased immediately from 330 to 400 mg/m<sup>3</sup>. This new level stayed constant according to the constant high feed level. At 18:00 the alumina feeding was set to zero and subsequently the HF concentration decreased down to a level of 210 mg/m<sup>3</sup>. At 18:30 the pots were switched back to normal operation, which is the demand and feed control. The HF concentration increased accordingly.

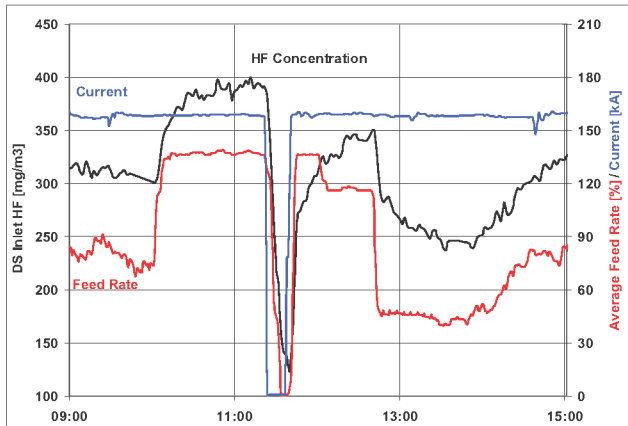

Figure 13: Raw Gas HF vs. Feed Rate and Current Experiment 2

Experiment 2 was carried out on the same pots but one day later than experiment 1. This time the current was manipulated as well. The line load was switched off between 11:25 and 11:40. The overfeeding and underfeeding modes were comparable to experiment one. At 11:25 the line load was taken off and the alumina feed was set to zero. Immediately the HF concentration decreased from 390 to 125 mg/m<sup>3</sup>. This low level represents the base level of the HF emissions (approximately 37 % of the nominal HF emissions) in the absence of alumina feeding and without any current passing through the cell. After the current and alumina feeding were re-established the HF concentration increased again.

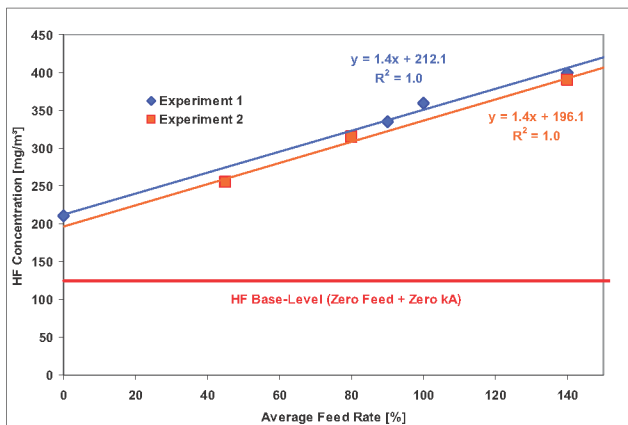

Figure 14: Raw Gas HF vs. Feed Rate (Correlation)

A summary in form of a regression analysis of these two experiments is shown in figure 14. It can be seen that both experiments show nearly the same relation between alumina feeding and HF concentrations. This demonstrates the robustness of this test method and the reliability of the test results. Certainly it has to be seen that the pot status has not changed much in the 24 hours between the experiments and that the alumina quality was un-

changed during this period. It can be seen that the regression functions for both tests are very similar:

$$HF = 200 + 1.4 \times \text{Feed Rate} \quad (1)$$

The interception of this graph at zero feed is around 200 mg/m<sup>3</sup> for both experiments. This represents the HF emissions from the pots without alumina feeding, but during routine electrolysis with the current on. The mechanism of HF generation through electrolysis is described by Hyland et. al. [1]. With the results of experiments 1 and 2 it is possible to distinguish between the HF generating effects. The amount of HF production by thermal hydrolysis and electrolysis can be extracted from Figures 12 and 13. The base level of 125 mg/m<sup>3</sup> (37 % of nominal emissions) represents the zero mode without current and alumina feeding (extracted from experiment 2). In this situation HF is only generated by hydrolysis between bath and air humidity. The HF emission contribution from electrolysis is the gap between the zero mode emissions and the interception of the graph at zero feed (200 mg/m<sup>3</sup> minus 125 mg/m<sup>3</sup>). This gap is about 75 mg/m<sup>3</sup> or equivalent to 22 % of the nominal emissions. The hydrogen source for this part of the HF emissions originates from the hydrogen in anodes and some of the structural water carried by the alumina. The remaining HF generation can be purely attributed to the alumina feeding. This means that the surface and crystal water carried by the alumina creates 140 mg/m<sup>3</sup> or 41 % of the nominal HF emissions during alumina feeding [4, 5].

### Results of the New Control Concept

The main purpose of this project was to stay well below the HF concentration limits under different operating conditions and with a wide range of raw materials. Another aspect was the necessity to increase the number of high purity pots. The increased amount of high purity metal was also the justification for the fast ROI of 2 months for this project. The system was taken into operation in 2004 and optimized in the following months.

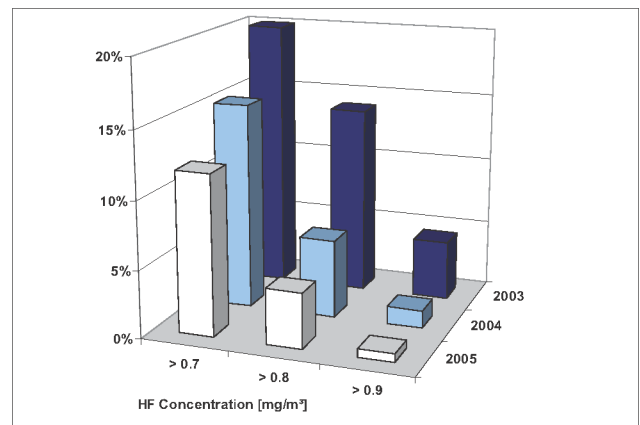

Figure 15: Development of HF Emissions from Stack

Figure 15 demonstrates the development of HF levels in the offgas of the dry scrubber. The bars show the share of time when the offgas was above 0.7, 0.8 and 0.9 mg/m<sup>3</sup>. The limit in Germany is 1 mg/m<sup>3</sup>. It can be seen that from 2003 until 2005 the share of concentrations above 0.7 mg/m<sup>3</sup> could be halved and the concentrations above 0.9 mg/m<sup>3</sup> could be reduced even more drastically.

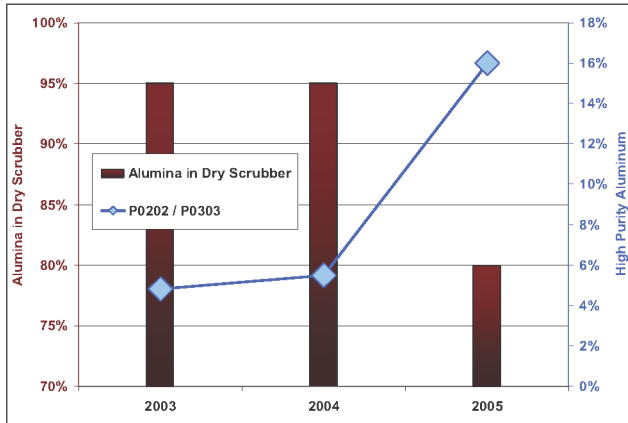

Figure 16: Alumina Consumption in DS and High Purity Al

Besides the reduction in HF concentration in the off gas, the amount of alumina used in the dry scrubber could be reduced by 15 % from 95 % in 2003 to 80 % in 2005. The share of high purity aluminum reached a level of 16 % in 2005 up from 4 % in 2003. This development can be seen from figure 16.

### Impact of Improved Scrubbing Efficiency on Bath Chemistry

Operating high purity cells means that those amounts of fluoride and bath are shifted from the high purity pots to conventional pots via the dry scrubber. Therefore a decrease in the amount of alumina fed to the dry scrubber leads automatically to an increase in fluoride loading of the secondary alumina.

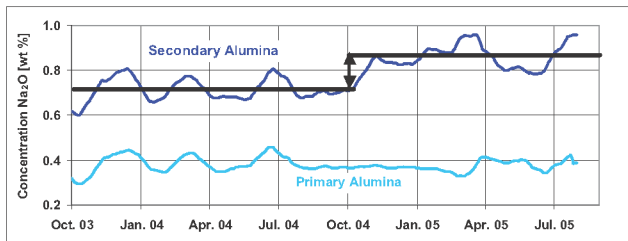

Figure 17: Development of Sodium Concentration

Diagrams 17 and 18 show the development of sodium and fluoride levels in the dry scrubber. Figure 17 displays the sodium level expressed as Na<sub>2</sub>O in the primary and secondary alumina over the last 2 years. Before the end of 2004 the average increase in sodium levels (expressed as Na<sub>2</sub>O) was 0.36 wt %. After the number of high purity pots was increased the enrichment in sodium levels raised to 0.48 wt %, which is equivalent to an increase of 33 %.

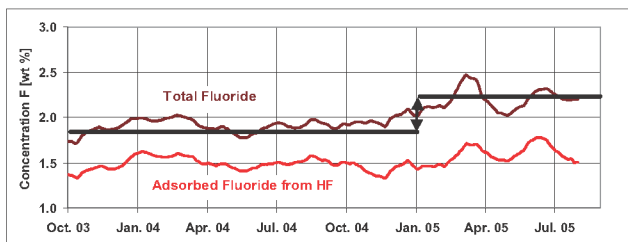

Figure 18: Development of Fluoride Concentration

The development in fluoride levels can be explained from figure 18. An increase in fluorination levels can be clearly observed

since the beginning of 2005. The average fluoride levels went up 15 % from 1.93 wt % to 2.21 wt %. The complete fluoride is a combination of bath vapors and gaseous HF emissions. Assuming the bath vapors being cryolite, the adsorbed HF can be back calculated as displayed in figure 18. The higher fluoride concentration in the alumina influences the bath chemistry quite remarkably. In a stable situation the fluorination and bath carried by the secondary alumina to the pots should balance (approximately 98%) the losses of the pots [2]. In a situation with pots running on primary alumina this balance will shift towards less fluoride consumption in the secondary alumina pots. This means extra bath production and less AlF<sub>3</sub> additions needed in the secondary alumina pots. If this is not taken into account it will cause a significant swing in bath chemistry and also energy balance will be affected [3].

### Conclusion

This paper discusses the influence of raw materials and operations on dry scrubbing efficiency and describes a low cost method to upgrade an existing dry scrubber. Therefore it is an alternative method to respond to the increased HF load delivered to the dry scrubber after increasing amperage, bath acidity and alumina hydroxyl contents in the alumina. All aspects leads to higher HF raw gas concentrations and hence need to be addressed in dry scrubber operations. Laser based HF measurements in the outlet of individual filter units makes it possible to reduce variations and overall HF emissions from dry scrubbers. It helps understanding the gas treatment process and helps optimizing the cleaning efficiency. Consequently it is possible to reduce the alumina usage in the dry scrubbing process and hence improve the metal quality spectrum through operation of primary alumina pots.

### REFERENCES

1. M. Hyland, E. C. Patterson, B. Welch, „Alumina Structural Hydroxyl as a continuous source of HF”, *Light Metals 2004*
2. B. J. Welch, „The Impact of Changes in Cell Heat Balance and Operations on the Electrolyte Composition”, *Proc. 6th Australasian Al Smelting Conference 1998*
3. S. E. Timpson, „A Smelter Fluoride and Sodium Balance”, *Light Metals 1992*
4. M. Hyland, E. C. Patterson, F. Stevens-McFadden, B. J. Welch, „Aluminium Fluoride Consumption And Control In Smelting Cells”, *Proc. 6th International Conference Molten Slags, Fluxes and Salts 2000*
5. E. Patterson, M. Hyland, B. Moxnes, B. Welch, „Reducing hydrogen fluoride emissions from aluminium electrolysis cells”, *Proc. 7th Australasian Smelting Technology Conference and Workshop 2001*
6. G. Wedde, T. Opsahl, „Retrofit of Dry Scrubbers Pays Back“, *Light Metals 2002*
7. M. Iffert, M. Skyllas-Kazacos, B. Welch, „Challenges in Mass Balance Control”, *Light Metals 2005*
8. M. Iffert, T. Rieck, P. White, „Use of state-of-the-art sensors to reduce energy consumption at the TRIMET aluminium smelter”, *Proc. EMC 2003*
9. H.I. Schiff, S. D. Nadler, J. Pisano, G. I. Mackay, „Measurements of HF in Stacks and Pot Rooms using a remote sensing Eye-safe Laser Instrument”, *Light Metals 1997*
10. R. Heger, A. Abbe, J. Pisano, M. Franz, „Intercomparison of three separate Technologies for the Measurement of HF Stack Emissions from the HAW Primary Aluminium Smelter”, *Light Metals 2000*