

تم تحميل هذا الملف من موقع المناهج الإماراتية



*للحصول على أوراق عمل لجميع الصفوف وجميع المواد اضغط هنا

<https://almanahj.com/ae>

* للحصول على أوراق عمل لجميع مواد الصف الثاني عشر اضغط هنا

<https://almanahj.com/ae/12>

* للحصول على جميع أوراق الصف الثاني عشر في مادة تصميم ولجميع الفصول, اضغط هنا

<https://almanahj.com/ae/12design>

* للحصول على أوراق عمل لجميع مواد الصف الثاني عشر في مادة تصميم الخاصة بـ الفصل الأول اضغط هنا

<https://almanahj.com/ae/12design1>

* لتحميل كتب جميع المواد في جميع الفصول للـ الصف الثاني عشر اضغط هنا

<https://almanahj.com/ae/grade12>

للتحدث إلى بوت المناهج على تلغرام: اضغط هنا

https://t.me/almanahj_bot



CDI Revision Notes

Term 1 (2017 – 2018)

Grade 12 General

Unit 1 – Materials & Unit 2 – Fundamentals of Electronics

STUDENT INSTRUCTIONS –

- Student must attempt **all** questions.
- For this examination, you must have:
 - (a) An ink pen – blue.
 - (b) A pencil.
 - (c) A ruler.
 - (d) A calculator (if required).
- Electronic devices are not allowed.

Examination Specifications

Domain	Marks	Time
Section 1 - 5 Multiple Choice Questions	5 Marks	3 - 4 minutes
Section 2 - 5 True or False Statements	5 Marks	3 - 4 minutes
Section 3 - 2 Short answer Questions	10 Marks (2 x 5)	8 - 10 minutes
2 Diagram Questions	20 Marks (2 x 10)	10 – 12 minutes
1 Matching Task	10 Marks	3 – 5 minutes
	Total – 50 Marks	Total – 35 minutes (5 minutes reading)



UNIT 1 - MATERIALS

SECTION 1 – MECHANICAL PROPERTIES

Compressive strength is the ability of a material to withstand compression.



Shear strength is the ability to withstand shear force.

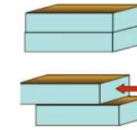

Bending strength is the ability to withstand bending.



Torsion strength is the ability to withstand twisting.



Tensile strength is the ability to withstand breaking when in tension (pulled apart).



Mechanical Properties

Word	Meaning
Properties	how materials perform in everyday use
Working characteristics	how a material behaves (acts) when it is shaped or formed
Raw materials	materials that are still in their natural form
Strength	the ability of a material to resist force without breaking or deforming
Hardness	the ability of a material to resist changing shape under force
Toughness	the ability of a material to withstand sudden impact before breaking
Elasticity	the ability of a material to bend and flex when a force is applied, and to return to shape and size when those forces are removed
Plasticity/ Malleability	the ability of a material to be stretched or formed into another shape and then hold that shape, without breaking or fracturing
Durability	the ability of a material to withstand wear, pressure or damage
Ductility	the measure of a material's ability to withstand tensile stress
Fracture	the separation of an object or material into two or more pieces under the action of stress



SECTION 2 – PHYSICAL PROPERTIES

Word	Meaning
Physical properties	how a material reacts to an external force that is not mechanical
Thermal Conductivity	how heat travels through a material
Electrical Conductivity	how a material resists an electric current being passed through it
Conductor	an object, or type of material that allows the flow of an electric current in one or more directions
Insulator	a material, or an object that does not easily allow heat, electricity, light or sound to pass through it
Magnetic Properties	the ability to attract or repel certain other materials
Acoustic Properties	how a material reacts to sound
Optical Properties	how a material reacts to light

Thermal Conductivity	
High Conductivity	Thermal Insulators
Materials that conduct heat easily	Materials that are poor conductors
Examples include: metals like copper and aluminum	Examples include: plastic, polystyrene foam
Electrical Conductivity	
Conductors	Insulators
Materials that allow electricity to pass through easily.	Materials that do not allow electricity to pass through easily
Examples include: copper, silver, brass and gold	Examples include: ceramics, glass and most plastics

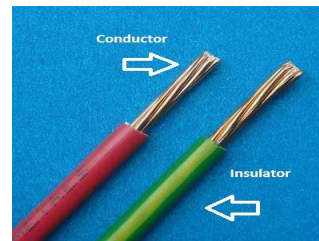



Acoustic Properties

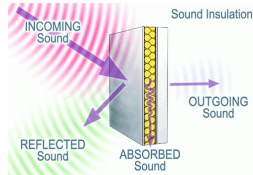

	Insulator	Reflector
Action	Absorbs Sound	Sound bounces off it
Examples	Soft materials & textiles	Hard surfaces
Uses	Carpets, curtains	Concert halls

Optical Properties

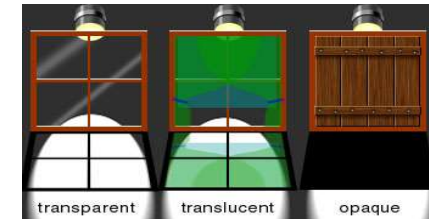

Opaque	Absorb or reflect all light. Impossible to see through. Example: Wood
Translucent	Allow some light to pass through. Example: Sunglasses
Transparent	Allow light to pass through easily. Example: Clear glass.

Magnetic Properties



Natural force

- Example: Lodestone
- Many steels are magnetic
- Like poles repel, opposites attract.

Superconductors can have little or no electrical resistance at low temperatures.

Benefits include:

- Power transmission without losses
- Super fast electronic circuits
- Powerful electromagnets
- Example: Mercury

Electromagnets are controlled by using an electric current









- Very powerful
- Magnetic field can be turned on or off by changing the current.

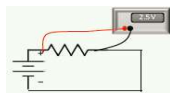

UNIT 2 – FUNDAMENTAL OF ELECTRONICS

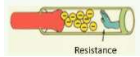
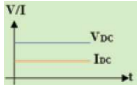
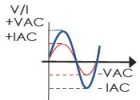
SECTION 1 – ELECTRICAL CIRCUITS

Word	Meaning	Image
Electrical Circuit	A closed path for electrons to move through electrical components, connected by a conductive wire.	
Schematic Diagram	A graphical representation of an electrical circuit that uses symbols.	
Voltage	The charge difference between two points.	
Current	The rate at which electric charge flows through a certain point.	
Resistance	A material's tendency to resist (oppose) the flow of charge (current).	
DC	An electric current that flows in one direction and has a constant voltage level; used in devices that use batteries or USB cables for power.	
AC	An electric current that periodically changes (alternates) its direction; the voltage level also reverses with the current; used to deliver power to houses, office buildings, etc.	
Battery	An electrical DC power source.	



INTRODUCTION

We use electricity in our daily lives to power our electric devices. **For example** –

- Cars get electric power from batteries.
- Computers, televisions, air conditioners, cell phone chargers & electric wall sockets.

Electric current is the flow of electric charge carried by electrons. Electrons are very small particles within atoms. They carry electric energy and flow through defined paths known as **electric circuits**.

Electronics is described as the science of dealing with electricity. **For example** - An electronic appliance has more functions than a simple electrical device. An electronic kettle could maybe send an SMS to your phone, telling you that your water is ready. A simple electric kettle **ONLY** boils water.

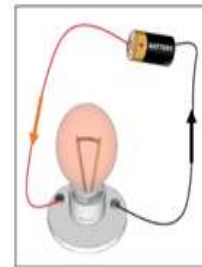

Electric Circuit : Group of electric components connected by conductors for current flow.

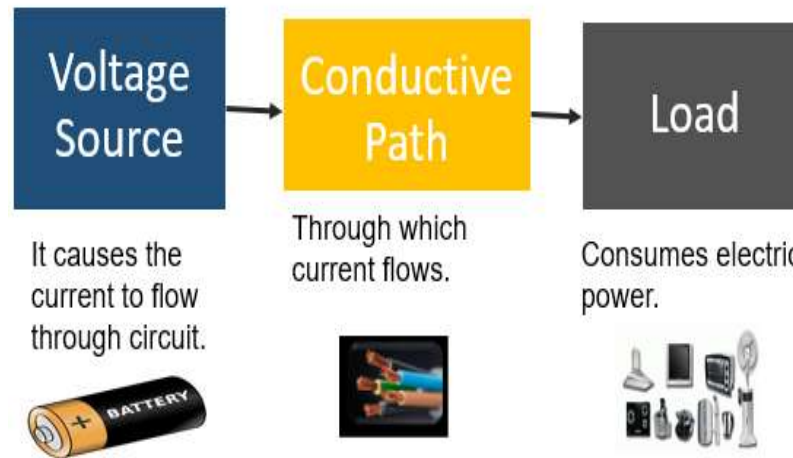

Types of Voltage Source

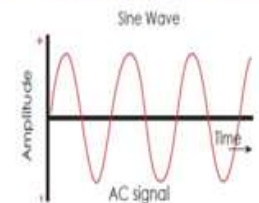

Alternating Current :
Wall Socket



Direct Current :
Battery



Ohm's Law

ELECTRICAL SCHEMATIC

An electrical wire	
A connected wire	
A disconnected wire	
A battery	
A light lamp or load	
Motor	

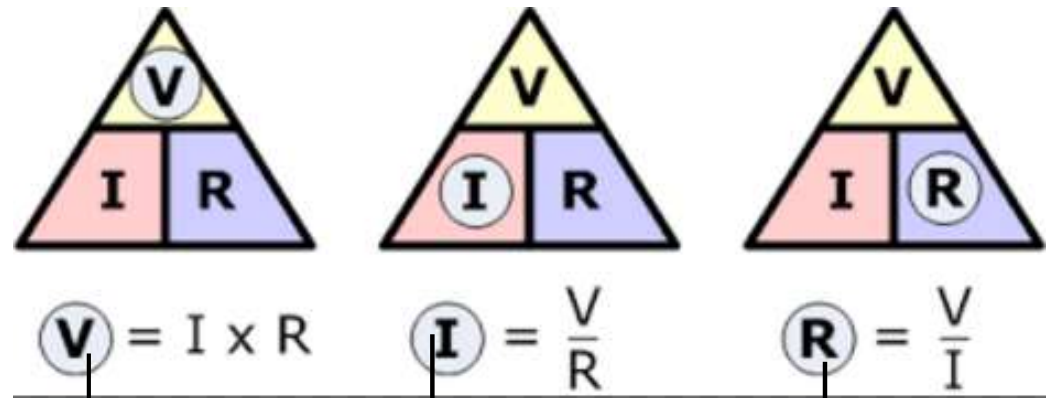
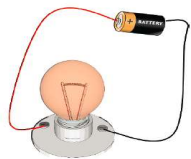

- **Voltage** is the difference in charge between two points.
- Measured in **Volts(V)**.

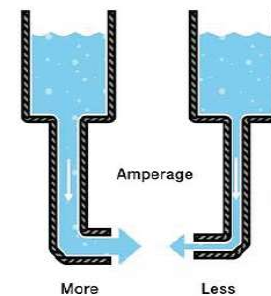
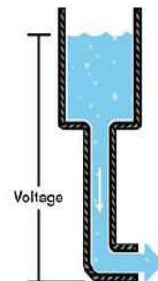

- **Current** is the rate at which charge is flowing.
- Measured in **Amperes(A)**.

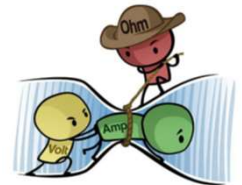

- **Resistance** is a material's tendency to resist the flow of charge (current).
- Measured in **Ohms(Ω)**.



Problem 1:

Using Ohm's Law, what is the **voltage difference** between point A and B if the **current** flowing through the resistor is **15 mA**, and the **resistance** is **100 Ω** ?

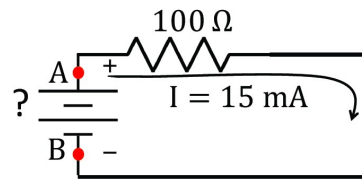

Solution:

$$V = I \times R = 0.015 \text{ A} \times 100 \Omega = 1.5 \text{ V}$$

Problem 2:

If the resistor in the previous example is replaced with another resistor, that has double the resistance, how much current would be flowing in the circuit using the same 1.5V battery as a voltage supply?

Solution:

$$\begin{aligned} V &= 1.5 \text{ V}, \\ R &= 2 \times 100 \Omega = 200 \Omega \\ V &= I \times R \rightarrow I = V / R = 1.5 \text{ V} / 200 \Omega = \\ &0.0075 \text{ A} = 7.5 \text{ mA} \end{aligned}$$

Problem 3:

Compare the value of the new current with the value of the initial current. Justify your answer.

Solution:

The new current is half the initial current (7.5 is half of 15). When the resistance was doubled, the current flowing became less (half the original current). This is because current is **INVERSELY** proportional to the resistance.

BATTERIES

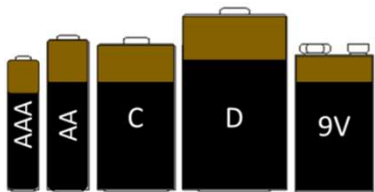

- A battery is a common DC power supply.
- A battery is made up of two plates. One plate is positively charged (+), the other plate is negatively charged (-).
- The plates are surrounded by a chemical solution called electrolyte.
- The electrical energy of a battery is made by converting the chemical energy of the battery. This happens when a chemical reaction between the plates and the electrolyte produces a voltage difference between the two plates.
- This makes the electrons flow and generates an electric current.
- The figure below shows some commonly used batteries that are available at the market. Each type has a different voltage.



SIGNAL - For receiving and sending information

1. Analog Signals

- This signal has infinite number of values.
- Stored in continuous form between minimum and maximum value.



Examples

- Brightness of sun
- Room temperature
- Speaker
- Mixing colors
- Old radio
- Old photograph



2. Digital Signals

- These signals have a finite set of possible values (0V or 5V).
- Stored in coded form (0,1) (min., max.)



Examples

- Light switch in class room.
- Power button of phone.
- Game controller buttons
- Calculator screen
- Digital camera
- Digital music player



SERIES CIRCUITS

- Electric current flows in **ONE** defined path in series circuits.
- The current must flow through the wires, all the way through both light bulbs and back to the battery.

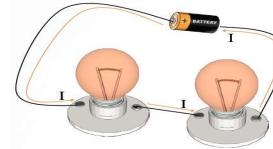

PARALLEL CIRCUITS

- In parallel circuits, electric current has more than one path.
- The components are connected to the same common points, this allows the current to be distributed over the paths.

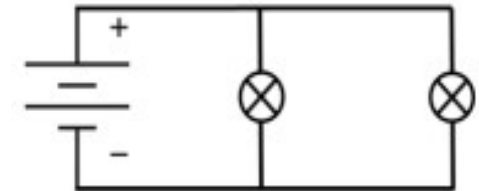
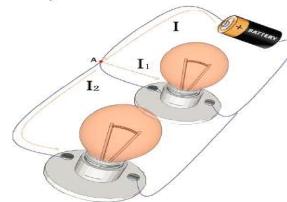



SECTION 5A – ELECTRONIC COMPONENTS

Word	Meaning	Image
Potentiometer	A 3-terminal variable resistor that allows us to adjust the value of the resistance by rotating a stainless-steel shaft.	
Rotary Rheostat	A 2-terminal variable resistor that allows us to adjust the value of the resistance by rotating a control dial.	
LDR	A variable resistor that changes its resistance depending on how much light falls on it.	
Thermistor	A 2-terminal variable resistor; it is an inexpensive temperature sensor that changes its resistance depending on the temperature.	
Fuse	An electronic safety device used for protecting electrical circuits from being damaged because of excessive current.	

Types of variable resistors -

- A variable resistor usually has four main parts, a wiper that rotates around 270°, a shaft to control the wiper, a resistive material and the terminals.

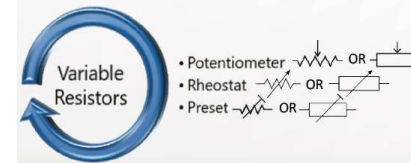

(A) Potentiometer

(B) Potentiometer terminals connections and schematic

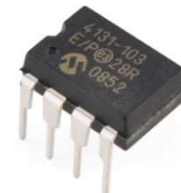
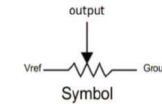
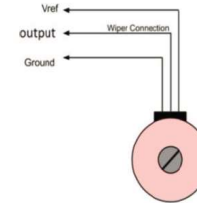

Digital Potentiometer (Preset) –

- Here, there is no shaft or control dial to change the resistance.
- The value of the resistance is voltage-controlled.
- We send digital signals to control the resistance just like we rotate the knob of a potentiometer.

Applications –

- Potentiometers – voltage dividers
- Rheostat – switching electronics, performs tuning or calibration



Special Resistors –

There are two types of special resistors:

• Light-Dependent Resistors (LDRs)

1. LDRs are mainly used when there is a need to spot absences or presences of light.
2. A camera light meter is an example.
3. They are also used in light sensitive switches street lamps, alarm clocks, burglar alarm circuits, light intensity meters and as light sensors.

LDR with Schematic Symbol

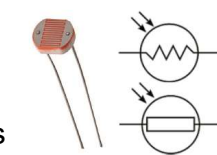

• Thermistors

1. A thermistor is a component that has a resistance that changes with temperature.
2. There are two types of thermistors, one whose resistance increases with temperature, and one whose resistance decreases with temperature.
3. Applications – temperature sensing, current limiting and circuit protection.

Thermistor with Schematic symbol

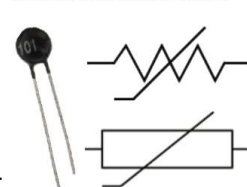

Switches –

- Switches are used to interrupt the flow of electrons in a circuit.
- They act as binary devices (1 or 0, ON or OFF).
- They are either completely ON, or completely OFF.
- The simplest type of switch is a switch where two electrical conductors are brought into contact with each other by the motion of actuators.

(A) Pushbutton switch

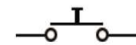

(B) Pushbutton Switch symbol (OFF)



(C) Pushbutton Switch symbol (ON)

Open State

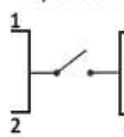

Close State

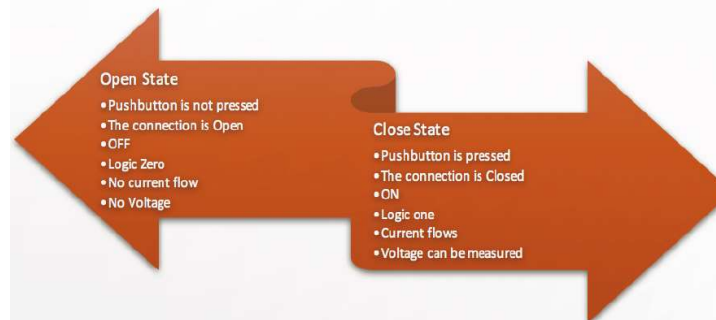
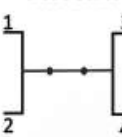

Mechanical switches and their symbols

Switch type	Diagram
Single-pole single-throw (SPST)	
Single-pole double-throw (SPDT)	
Double-pole single-throw (DPST)	
Double-pole double-throw (DPDT)	

A) Toggle switch



(B) Toggle switch symbol (OFF = Open)

(C) Toggle switch symbol (ON = Close)



Fuse –

It is an electrical safety device (component) that removes electrical current from an electrical circuit when the current in the electrical circuit is too high.

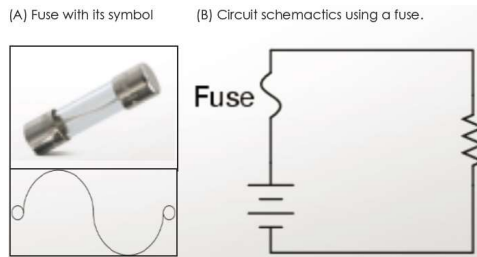

3 Amp fuse, 13 Amp fuse and a 10 Amp



Good Fuse



Blown Fuse



- A fuse is a length of wire that melts (breaks or blows) when the current passing through it is above a certain level. This level is called the **fuse rating**.
- The fuse rating is the electrical current that will blow or break the fuse.
- For example, 3 Amp, 10 Amp or 13 Amp could be the rating.
- We can describe a fuse to be a current sensitive piece of wire.
- When the fuse is working, the wire is not broken. The wire breaks when the fuse is blown.

Why does a fuse blow?

A fuse blows when the electric current passing through the fuse is high enough to melt the wire inside it.

Fuse rating

The fuse rating can be calculated using the following formula:

$$\text{Fuse rating} = \left(\frac{\text{Power (Watt)}}{\text{Voltage (V)}} \right) \times 1.25$$

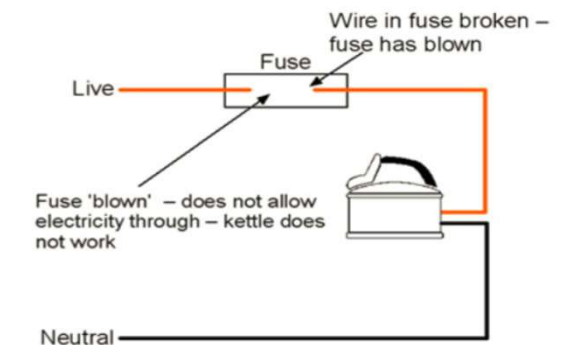
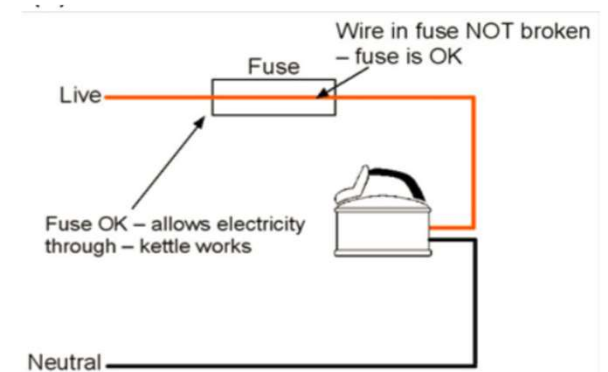



Diodes -

- A **diode** is an electronic component with two terminals.
- It allows current to flow in only **one** direction.

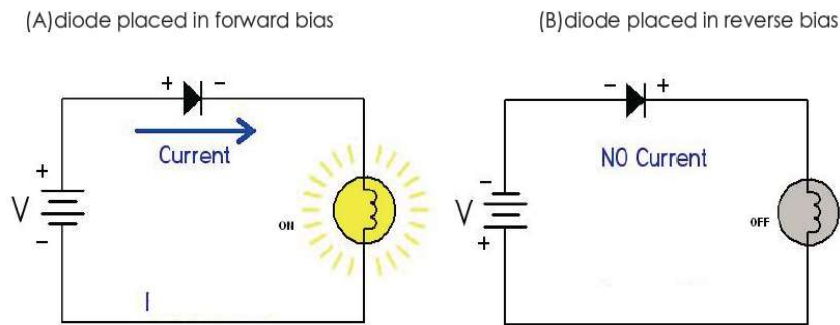

- **LED** stands for Light Emitting Diode.
- An LED has **no filament** that produces light when electricity passes through it.
- LEDs use advanced **semiconductor** material.
- They are, for example, found inside computer chips.
- LEDs are better than traditional light bulbs. This is because they last longer and use much less power.

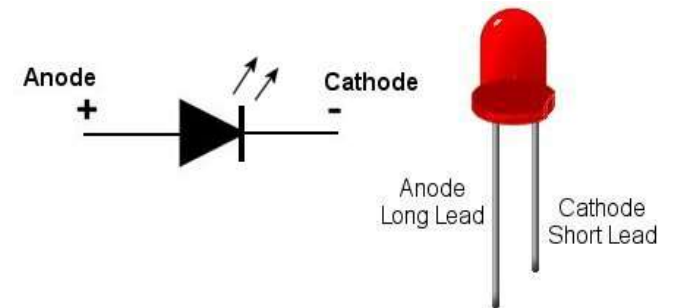
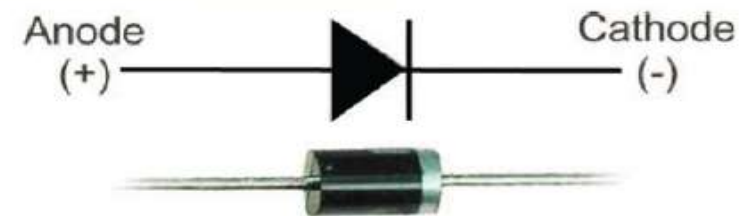



SECTION 5a – 5c : ELECTRICAL COMPONENTS

- A capacitor is a device that stores energy in the form of an electrical field that produces a potential difference across its plates (much like a small rechargeable battery)

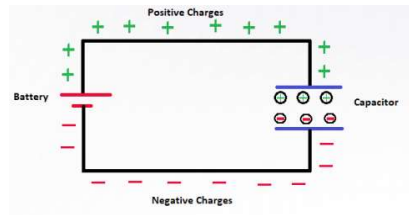

Capacitance equation:

$$C = \frac{q}{V}$$

Capacitance equation

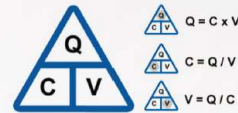
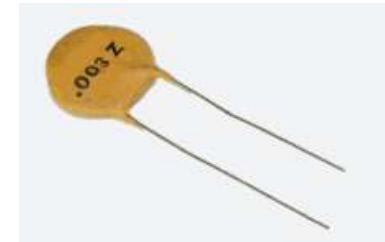

Fig. 2.69

The relationship between capacitance, charge and voltage.

- Positive pole = Long Leg
- Capacitance can be changed by:
 - Increasing the surface area of the electrode
 - Shortening the distance between the electrodes
 - Using materials that have a high dielectric constant

- Ceramic Capacitors
 - Non Polar



- Electrolytic Capacitors
 - Have positive and negative poles





SECTION 6 – RELAY, 555 TIMER and OP - AMP

Word	Meaning	Image
Relay	It is an electromagnetic switch that can be enabled by a small electrical signal and controls a much larger electrical current.	
IC (Integrated Circuit)	Integrated circuits are advanced circuits that contain many electronic components such as transistors, diodes, resistors and capacitors, all fixed (integrated) into a micro silicon chip.	

Word	Meaning	Image
Pulse	A quick change in the value of a signal, from the original value to a higher or lower one, then going back to the original value again.	
Electrical Oscillation	A regular variation about a certain central point in magnitude or position for current or voltage.	

- There are 2 main circuits in a relay system -
 1. Control Circuit
 2. Load Circuit
- When power flows through the first circuit , it activates the electromagnet which generates a magnetic field. This magnetic field attracts the connector and activates the second circuit.
- Applications - fridges, washing machines, dishwashers and AC controls.

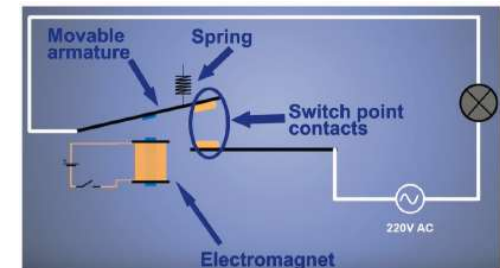
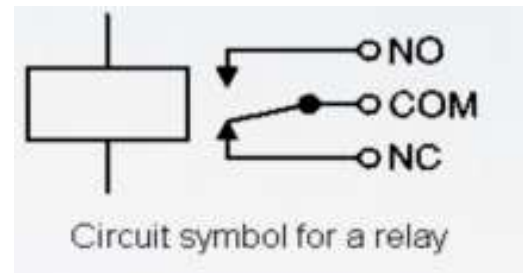



Control circuit and load circuit of a relay

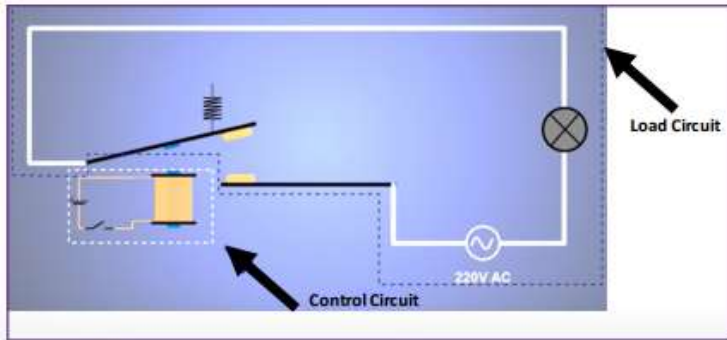

Solid State Relays

- Have **no coil, spring, or mechanical contact** switch.
- Much **faster** response time than electromagnetic relays.
- Made from **Semiconductor** materials.



Solid State Relays

Relay Applications



Car Indicator Light

Relays are used for powering car turning signal lights and many other devices. These are called “flashers”. It’s a type of relay with three terminals and the body works as the earth, in old Japanese cars like old Toyotas.

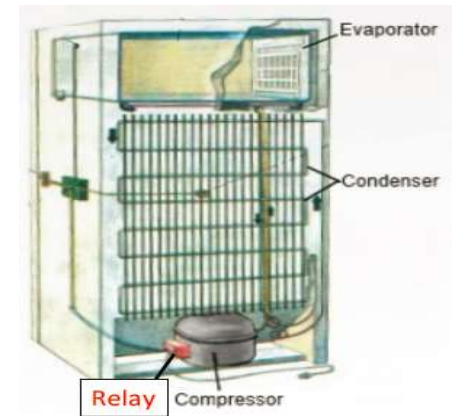

Fridge

Relays are commonly used in home appliances, like refrigerators for example, where there is an electronic control turning on a motor.



OP - AMPS

- Amplifiers are devices that take a weak signal as an input and produce a much stronger signal as an output.
- The operational amplifier (Op-amp) is a special kind of amplifier.
- Applications - stereos, medical cardiographs (which amplify the heart beat) and comparator.
- Op-amps are integrated circuits that combine many transistors, resistors and capacitors into a small silicon chip. We can represent them in circuit diagrams as shown in the following figure.

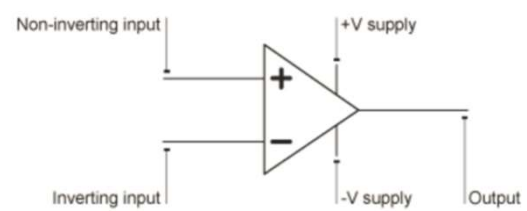

(A) 741 Op-amp

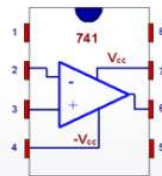

(B) Op-amp Circuit Diagram

An op-amp has two different inputs:

- An inverting input - Signals going into the inverting input will be 1) amplified and 2) inverted (flipped).

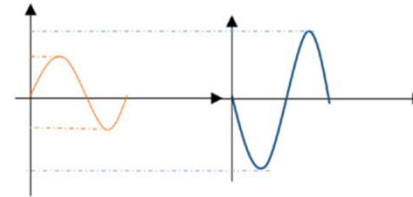

I/O of Inverting Op-amp

- A non – inverting input - Signals going into the non-inverting input will be just amplified.

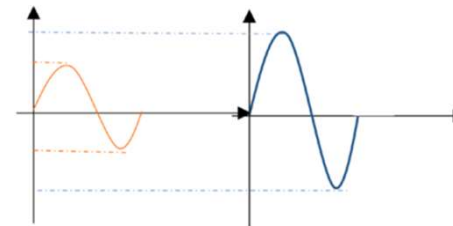

I/O of Non - Inverting Op-amp



Gain of an operational amplifier

- Op-amps have a high voltage gain of around 100,000. Negative feedback is used to control the gain of an op-amp as shown below.

The gain of an op-amp with negative feedback is calculated by:

$$\text{Gain} = - \frac{R_f}{R_{in}}$$

- Gain has no units and is just a mathematical value. The minus '-' sign shows that the output will always be inverted when compared to the input.

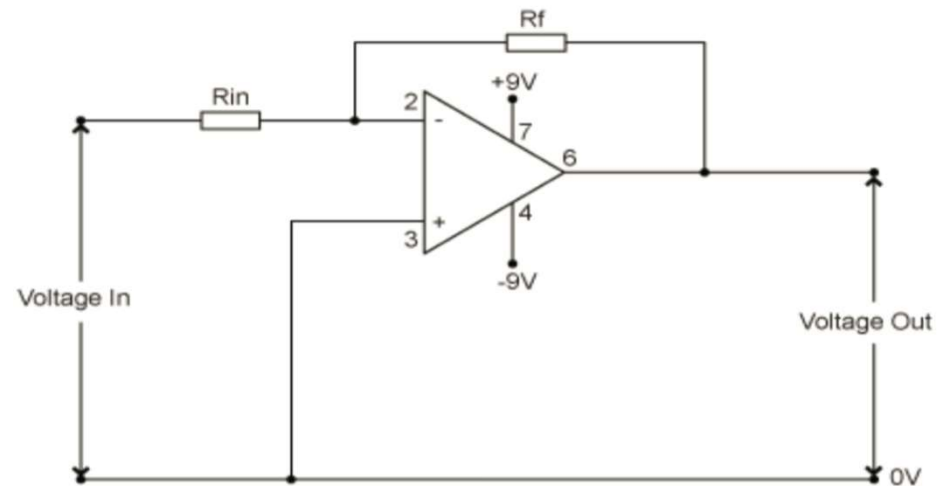

The output of the op-amp (Pin 6) is connected to the Negative Input, making a negative feedback. Negative feedback used to control the gain of an op-amp.



555 Timer

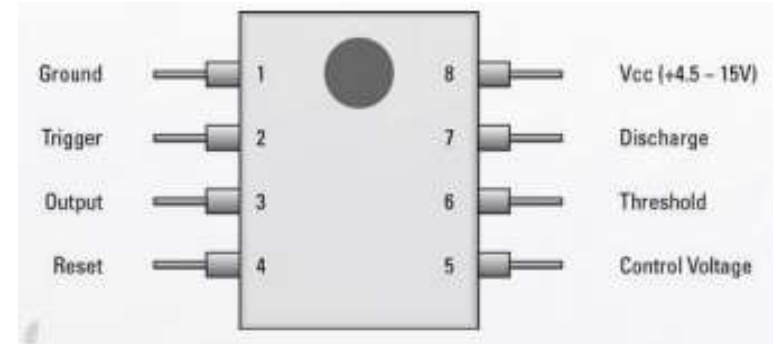

- The 555 timer is a single-chip version of a commonly used circuit called a multi-vibrator.
- It is used in a variety of timers, pulse generators, and oscillator applications.
- The 555 timer IC contains a lot of transistors, resistors and diodes. It has three 5 k Ω resistors, thus has the name 555 timer.
- We use 555 timers to produce an oscillated output.
- For example, we can use a 555 timer to make an LED blink ON and OFF.
- 555 timers allow us to choose how frequently this blinking should occur (frequency). If we control the frequency, we are indirectly controlling the time, thus the name 'timer'.
- The chip can be used for timing functions such as - turning on a light for a period of time, a warning light to flash on/off and produce musical notes.
- The 555 timer IC operates in three modes which are, **astable mode**, **monostable mode**, and **bistable mode**.

555 timer schematic diagram

