

Comprehensive

BIOCHEMISTRY

Dr. Adel M.A. El-Asfahani

M.D., Ph.D., Biochemistry (Tokyo)

Member, American Academy of Allergy & Immunology

Chairman, Medical Biochemistry Dept.,

Faculty of Medicine, Alazhar University.

Vol. I (Part I)

2001

مركز الكتاب للنشر

29/52

حقوق الطبع محفوظة للمؤلف

الطبعة الأولى

٢٠٠١



مصر الجديدة : ٢١ شارع الخليفة المأمون - القاهرة
ت: ٢٩٠٨٢٠٣ - ٢٩٠٦٢٥٠ - فاكس: ٢٩٠٦٢٥٠
مدينة نصر: ٧١ شارع ابن النفيس - المنطقة السادسة - ت: ٢٧٢٣٣٩٨

مطابع أمون

٤ الهرموز من ش إسماعيل أباطة
لايفرلى - القاهرة
تليفون : ٧٩٤٤٣٥٦ - ٧٩٤٤٥١٧

بِسْمِ اللّٰهِ الرَّحْمٰنِ الرَّحِیْمِ

Dedicated to :

*My Wife and Children for their
Patience and encouragement untill
this book was born.*

Preface

This book is prepared to meet the needs of the first-year medical students. From my long experience with undergraduate and postgraduate medical students, I found that the comprehension of biochemistry is generally poor than that of the other medical sciences. The average medical student is unable to grasp the subject satisfactorily. The problem is that there is an intimate relationship between organic & physical chemistry and biochemistry. In addition the first-year medical student is not yet prepared to appreciate the significance of clinical and pathological biochemistry.

This book dealt with the above problems and emphasis was made in including little and simplified fundamentals of organic and physical chemistry whenever needed. Clear description of structure & function of substances of major biological importance like collagen, hemoglobin, myoglobin, lipoproteins, proteoglycans and others, was attempted. Disease states were introduced with emphasis on change of normal body biochemical structure. Important facts are typed in bold prints in order to allow the reader to rapidly understand and remember the significant facts and concepts. Many up-to-date illustrations were included which were carefully selected and properly fitted.

I am indebted to those members of the Medical Biochemistry Dept., Faculty of Medicine, Alazhar University, who sincerely supported editing and publishing this book in a concise form, which I think it was a hard job.

Finally I wish to convey my thanks to my friend Mr. Kadry Tawfik for his patience, politeness and skillful help during the preparation of this book.

Cairo, 2000

Adel M.A. El-Asfahani, M.D., Ph.D.

CONTENTS

	Page
Carbohydrates -----	1
Lipids-----	27
Amino acids-----	59
Peptides-----	68
Proteins-----	70
Membranes-----	90
Nucleotides-----	101
Nucleic acids-----	108

CARBOHYDRATES

Definition:

Carbohydrates are organic substances composed of polyhydroxylic aldehydes & ketones (monosaccharides, oligosaccharides and polysaccharides) and their products (sugar alcohols, acids and esters and amino sugars).

Importance:

- 1) Major source of energy.
- 2) Enter in the structure of biologically important compounds as glycolipids, glycoproteins, heparin, nucleic acids etc.
- 3) Starting materials for the synthesis of fatty acids and certain amino acids.

Classification:

- 1) Monosaccharides: Simple sugars (3-9 carbons).
- 2) Oligosaccharides: 2-10 monosaccharide units.
- 3) Polysaccharides: more than 10 monosaccharide units.

MONOSACCHARIDES

Definition: Simple sugars, which cannot be hydrolysed.

Classification:

A) According to the number of carbon atoms in the chain:

- 1) Trioses (3 carbons): glyceraldehyde, dihydroxyacetone and glycerol.
- 2) Tetroses (4 carbons): erythrose, erythrulose.
- 3) Pentoses (5 carbons): ribose, ribulose, xylose, xylulose.
- 4) Hexoses (6 carbons): glucose, galactose, fructose, mannose.
- 5) Heptoses (7 carbons): sedoheptulose.
- 6) Nonoses (9 carbons): neuraminic acid.

B) Aldoses & Ketoses:

Monosaccharide might contain either an aldehyde group (aldose) or keto group (ketose). These groups are the oxidized functional groups.

- Add the suffix-ose for aldoses (have free carbonyl gr.).
- Add the suffix-ulose for ketoses except for fructose.

Trioses: 1) Contain 3C.

2) Occur as intermediates during breakdown of glucose (glycolysis).

3) Form glycerol which is incorporated into lipids.

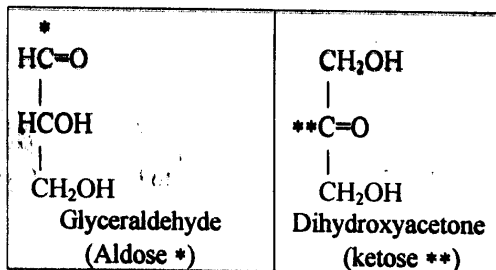

Tetroses:

1) Contain 4C.

2) Few of them are intermediates in carbohydrate metabolism.

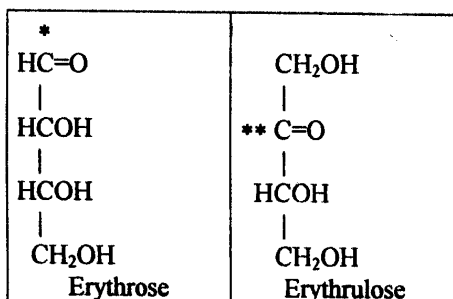

Pentoses:

1) Contain 5C.

2) Include D-Ribose, D-Ribulose, D-Xylose, L- Xylulose, D-Arabinose. & L-Fucose.

3) Importance:

a) D- Ribose: enters, into structure of nucleic acids, coenzymes (ATP, NAD, FAD), vit B₂ or riboflavine and as an intermediate in pentose phosphate pathway.

- b) D- Ribulose is an intermediate in pentose P. Pathway.
 c) L-Xylulose is an intermediate in uronic acid pathway. It appears in urine in patients with essential pentosuria.
 d) D- Arabinose & D- Xylose are present in gum, fruits & glycoproteins

$ \begin{array}{c} * \\ \text{HC=O} \\ \\ \text{HCOH} \\ \\ \text{HCOH} \\ \\ \text{HCOH} \\ \\ \text{CH}_2\text{OH} \end{array} $	$ \begin{array}{c} \text{CH}_2\text{OH} \\ \\ **\text{C=O} \\ \\ \text{HCOH} \\ \\ \text{HCOH} \\ \\ \text{CH}_2\text{OH} \end{array} $	$ \begin{array}{c} * \\ \text{HC=O} \\ \\ \text{HCOH} \\ \\ \text{HOCH} \\ \\ \text{HCOH} \\ \\ \text{CH}_2\text{OH} \end{array} $	$ \begin{array}{c} \text{HC=O} \\ \\ **\text{C=O} \\ \\ \text{HOCH} \\ \\ \text{HCOH} \\ \\ \text{CH}_2\text{OH} \end{array} $
Ribose	Ribulose	Xylose	Xylulose

Hexoses:

- 1) Contain 6C.
- 2) Include: glucose, galactose & mannose (aldoses) and fructose (ketose).
- 3) Importance:
 - a) Glucose occurs in animal and plant cells and in blood, honey & fruits. It is part of disaccharides (maltose, sucrose and lactose) and polysaccharides (starch, glycogen and cellulose).
 - b) Galactose occurs in lactose in milk (glucose + galactose) and in glycosphingolipids (cerebrosides & gangliosides) and glycoproteins.
 - c) Mannose occurs in glycoproteins. Fructose (ketose) occurs in fruits, honey and semen. It is part of the disaccharide sucrose (glucose + fructose).

$ \begin{array}{c} \text{HC=O} \\ \\ \text{HCOH} \\ \\ \text{HOCH} \\ \\ \text{HCOH} \\ \\ \text{HCOH} \\ \\ \text{CH}_2\text{OH} \end{array} $	$ \begin{array}{c} \text{HC=O} \\ \\ \text{HCOH} \\ \\ \text{HOCH} \\ \\ \text{HOCH} \\ \\ \text{HCOH} \\ \\ \text{CH}_2\text{OH} \end{array} $	$ \begin{array}{c} \text{HC=O} \\ \\ \text{HOCH} \\ \\ \text{HOCH} \\ \\ \text{HCOH} \\ \\ \text{HCOH} \\ \\ \text{CH}_2\text{OH} \end{array} $	$ \begin{array}{c} \text{CH}_2\text{OH} \\ \\ \text{C=O} \\ \\ \text{HOCH} \\ \\ \text{HCOH} \\ \\ \text{HCOH} \\ \\ \text{CH}_2\text{OH} \end{array} $
Glucose	Galactose	Mannose	Fructose

Note: Galactose is the epimer of glucose (OH group on C₄ of glucose is on the right while that of galactose is on the left).

Structure of monosaccharides:

- A) Asymmetric carbon atom:** 1) A carbon atom attached to it four different groups. 2) All monosaccharids have asymmetric carbon atoms.
- 3) Glyceraldehyde has one asymmetric carbon (C₂). Glucose has 4 asymmetric carbons (C₂, 3, 4 & 5).

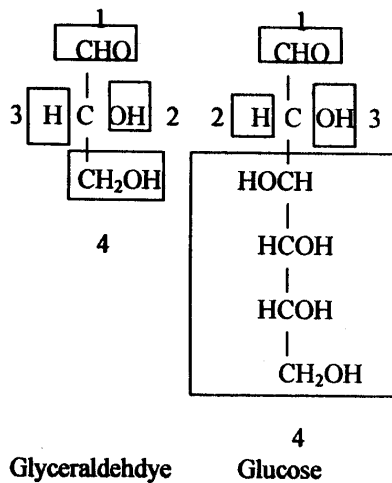

B) Isomers:

- 1) Isomers are compounds that have the same chemical formula (glucose, galactose, mannose & fructose are isomers).
- 2) The presence of asymmetric carbons in a compound allows the formation of several isomers depending on the number of asymmetric carbons (glucose has 4 asymmetric carbons and has $2^4 = 16$ isomers).

C) Epimers:

Two monosaccharides that differ in conformation around only one carbon:

- 1) glucose & galactose are C_4 epimers. 2) glucose & mannose are C_2 epimers.

D) D & L isomerism:

The property of subterminal carbon atom in a monosaccharide:

- 1) D form: when OH group extends to the right.
- 2) L form: when OH group extends to the left.
- 3) D & L forms are isomers and mirror image to each other (enantiomorphs) and are not related to the optical activity of the compound.
- 2) Only D & L glyceraldehyde forms are related to the optical activity of the compound (they are dextro- & levorotatory, respectively).

$\begin{array}{c} \text{CHO} \\ \\ \text{HCOH} \\ \\ \text{CH}_2\text{OH} \end{array}$	$\begin{array}{c} \text{CHO} \\ \\ \text{HOCH} \\ \\ \text{CH}_2\text{OH} \end{array}$	$\begin{array}{c} \text{CHO} \\ \\ \text{HCOH} \\ \\ \text{HOCH} \\ \\ \text{HCOH} \\ \\ \text{HCOH} * \\ \\ \text{CH}_2\text{OH} \end{array}$	$\begin{array}{c} \text{CHO} \\ \\ \text{HCOH} \\ \\ \text{HOCH} \\ \\ \text{HCOH} \\ \\ \text{HOCH} * \\ \\ \text{CH}_2\text{OH} \end{array}$
D-Glyceraldehyde	L-Glyceraldehyde	D-glucose	L-Glucose

- 5) Most monosaccharides in mammals are D isomers and enzymes responsible for their metabolism are specific for this configuration.

E) Enantiomers or mirror images:

- 1) It is the mirror image of an isomer (two isomers are enantiomers).
- 2) Enantiomers rotate a plane of polarized light to the same extent but to the opposite direction & are called optical antimers

F) Straight chain structure:

Less than 1% of each sugar with 5 or more carbons is found in the open chain structure.

G) Ring structure (Hemiacetal & Hemiketal) (Fischer projection):

- 1) Ring structure of a monosaccharide form by condensation reaction between aldehyde (or keto) group and an OH group on the same molecule when it is dissolved in water.
- 2) If the ring has 4C and one oxygen it is a furanose ring.
- 3) If the ring has 5C and one oxygen it is a pyranose ring.
- 4) The ring structure of aldose is hemiacetal and that of ketose is hemiketal.
- 5) More than 99% of glucose in solution is in pyranose structure.

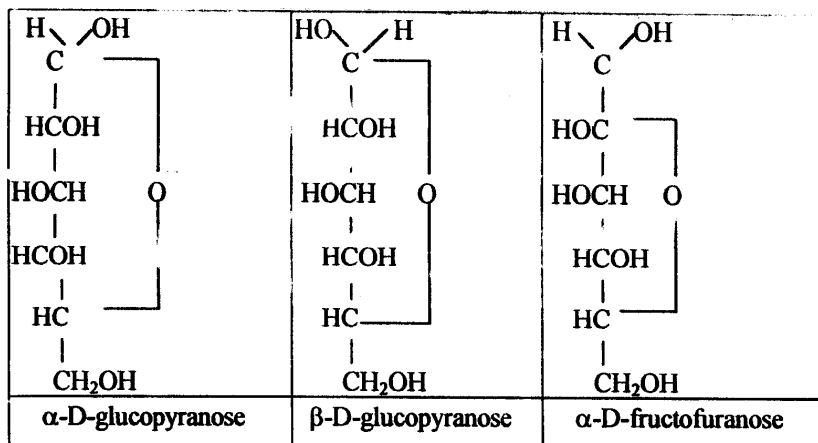

- 6) Carbonyl carbon C_1 (aldose) and C_2 (ketose) become asymmetric and are termed **anomeric carbons** and can have two forms: α (OH on the right) and β (OH on the left). These two forms are monosaccharide anomers.
- 7) α & β cyclic compounds will have different optical activity.
- 8) α & β forms of a sugar in solution are interconvertible and in equilibrium with each other because the ring structures open to the straight chain form during the interconversion.

F) Haworth projection:

- 1) It is either the hemiacetal or hemiketal rings changed to hexagons (pyranoses) and pentagons (furanoses).
- 2) The plane of the ring is flat on the paper and C_1 is on the right.
- 3) H, OH and CH_2OH groups are projecting above or below the plane of the ring (paper).

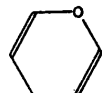

Pyran

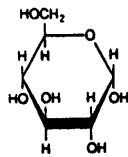
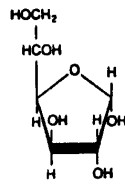
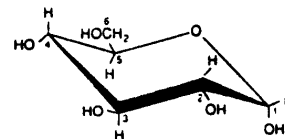

Furan

 α - D - glucopyranose α D - glucofuranose

Chair form

- 4) α & D isomers have OH group projecting downwards (right side in Fischer projection). β & L isomers have OH group projecting upwards (left side in Fischer projection).
- 5) It is the true picture of the molecule & it is actually present in the form of a "chair".

Optical isomerism:

A) Definition: It is the ability of an isomer to rotate the plane polarized light either to the left or to the right.

B) Plane polarized light: (PPL):

- 1) A beam of ordinary light is a bundle of electromagnetic waves vibrating in all directions perpendicular to the axis of the beam.
- 2) When this light passes through a Nicol prism (calcite, CaCO_3 crystal cut along a certain plane) all vibrations are reflected except those in one plane (plane polarized light) (PPL).
- 3) If PPL passes through a glass column containing an optically active isomer, the plane will rotate either to the right (dextrorotation, + or d) or to the left (levorotation, - or L).
- 4) The angle of rotation is measured by a polariscope.

C) Optical activity is due to the presence of asymmetric carbons and is the resultant of the presence of several of them.

1) Glucose is dextrorotatory (dextrose).

Fructose is levorotatory (levulose).

2) Specific rotation:

- It is the angle of rotation of a solution of optically active compound measured under certain conditions:

a) Dissolved in H_2O .

b) Concentration = 1 g/ml.

c) Temperature = 20°C .

d) 10 cm length of polariscope tube.

e) Sodium light.

- Specific rotation for D-glucose = +52.5 and for fructose = -94.

- A compound may be D (-) or D (+), L (-) or L (+) indicating that D & L compounds are not necessarily having the same optical activity as D & L

glyceraldehydes. Naturally occurring fructose is D (-) isomer.

D) Racemic mixture:

When an equal amounts of D & L isomers are mixed, no optical activity is obtained since the activities of each isomer cancel one another.

E) Mutarotation:

It is the change in specific rotation of freshly prepared watery solutions of a sugar on standing (left for a certain time).

- **Example:** A freshly dissolved solid glucose in water will have two types of specific rotation:

a) +110 then gradually decreases to a fixed value = +52.5. or

b) +17.5 then gradually increases to a fixed value = +52.5.

- It is due to that solid glucose occurs in two ring structures: i) α -D-glucose (+110). ii) β -D-glucose (+17.5).

In solution the ring form of glucose is opened then recycles again with interconversion between α & β glucopyranoses. In equilibrium both α and β forms are present and specific rotation of +52.5 is obtained.

Physical properties of monosaccharides:

1) Optically active. 2) Char by heat. 3) Soluble in water.

4) Most are sweet (mannose is bitter).

Chemical properties of monosaccharides:

A) Sugar acids:

1) Aldonic acids: by oxidation of aldehyde group to carboxyl

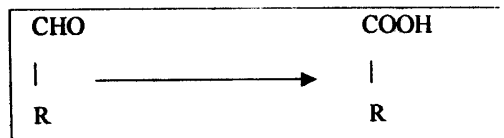

a) Glucose → gluconic acid which is an intermediate in pentose synthesis.

b) Vit C is an aldonic acid derivative of L-hexose.

2) Uronic acids: by oxidation of the last primary alcohol gr.

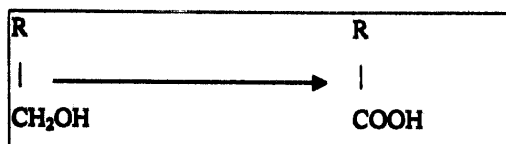

It is a component of mucopolysaccharides.

3) Saccharic acids: oxidation of both ends of monosaccharide.

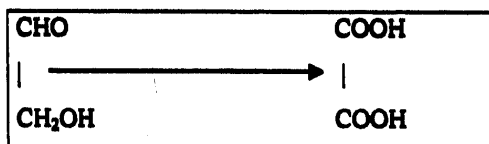

a) Saccharic acid from D-glucose. b) Mucic acid from D-galactose.

B) Sugar alcohols:

Produced by reduction of carbonyl group.

1) Glucose → sorbitol. 2) Mannose → mannitol. 3) Ribose → ribitol.

5) Galactose → dulcitol. 5) Fructose → sorbitol and mannitol.

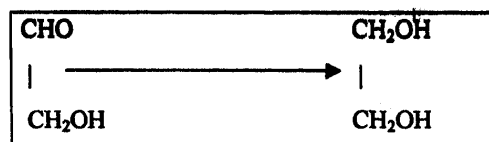

Importance:

a) Of commercial importance as synthetic intermediates.

b) Cycliribitol is part of Vit B₂.

C) Deoxyribose formation:

Produced by reduction of OH group of C₂ of ribose

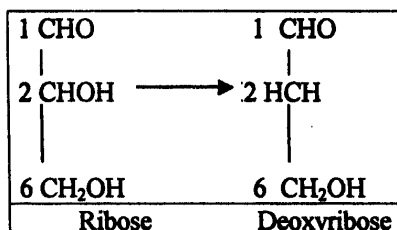

Importance: for DNA synthesis.

D) Reducing properties of aldoses & ketoses:

If the aldehyde group of aldose and ketol group of a ketose are free they will reduce other compounds and themselves become oxidized.

Importance: It is the basis of detection of glucose in urine (Benedict test) and blood (glucose oxidase test) in diabetic patients.

E) Action of acids:

Concentrated H_2SO_4 dehydrate monosaccharides \rightarrow cyclic furfural compounds. In the presence of α -naphthol a purple ring appears.

(Molish's test for detection of carbohydrates)

F) Action of alkalis:

Strong alkalis (NaOH) + heat \rightarrow cleavage and polymerization \rightarrow caramel (Moors test).

G) Alcoholic fermentation:

- Transformation of sugars by yeast into ethyl alcohol and CO_2 .
- Only D-sugars are fermented (L-sugars & pentoses are not).
- Disaccharides are first hydrolysed to monosaccharides (lactose is not fermented due to absence of lactase).

- Steps:

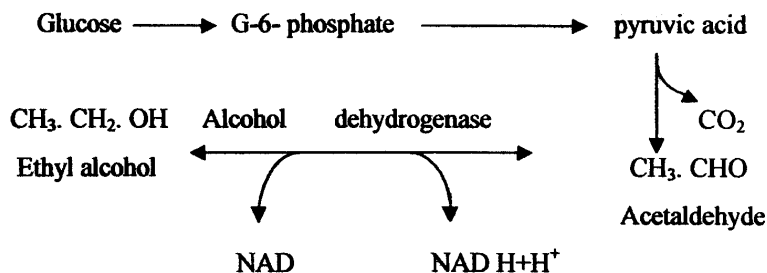

H) Amino sugars:

- 1) Formed by replacement of C_2 of a sugar with amino group.

- 2) Examples: glucosamine, galactosamine & mannosamine and their acetylated forms (N-acetylglucosamine & N-acetylgalactosamine). They are present in proteoglycans and gangliosides.

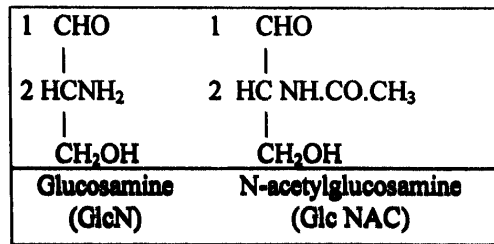

I) Amino sugar acids:

- 1) Formed by adding acids to aminosugars.
- 2) Present in proteoglycans & gangliosides.
- 3) Example: a) Neuraminic acid: Mannosamine + pyruvic acid.
- b) N-acetylneuraminic acid (NANA) (sialic acid).

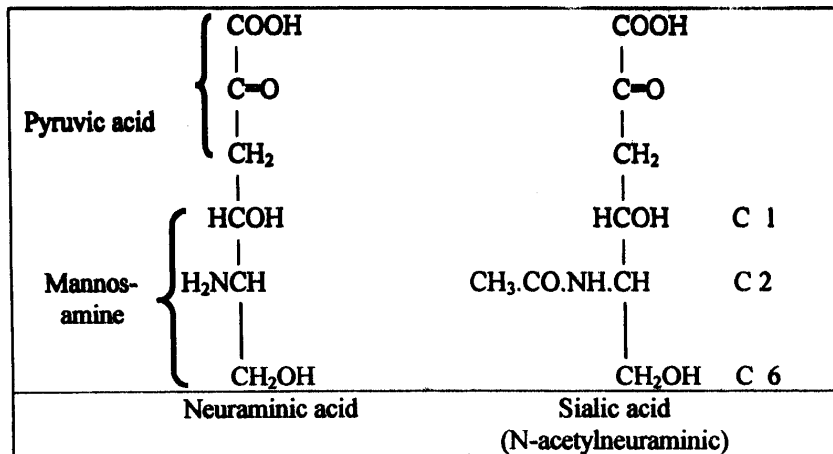

G) Glycoside formation:

- 1) Condensation products of sugars with alcohols or phenols.
- 2) The link is glycosidic linkage between either C₁ (of aldose) or C₂ (of ketose) and another sugar, alcohol or phenol through an oxygen atom.
- 2) The linkage may be α or β glycosidic (glucosidic for glucose; galactosidic

- 4) If the glycosidic linkage involves the carbonyl group of a sugar, the sugar on that side of the linkage will be nonreducing.
- 5) Examples:
- Disaccharides, oligosaccharides and polyaccharides: Sugars are bound to another sugar by glycosidic linkage.
 - Sugar + nonsugar radical (aglycon):
 - Digitalis (cardiotonic drug): galactose + steroid alcohol.
 - Nucleosides : ribose + purine or pyrimidines.
 - Glycolipids: sugars linked to lipids (cerebrosides).

DISACCHARIDES

Definition:

- Two monosaccharides joined by glycosidic linkage.
- If the glycosidic linkage is between C₁ (carbonyl gr.) of BOTH sugars (as in sucrose) the resulting disaccharide is non-reducing and does not mutarotate.
- If the glycosidic bond involves only ONE carbonyl group and the other carbonyl group is free, the disaccharide is reducing and mutarotates (maltose & lactose).

Maltose:

- It is malt sugar and present in germinating barley. It is the main product after digestion of starch by amylase enzyme in the intestine.

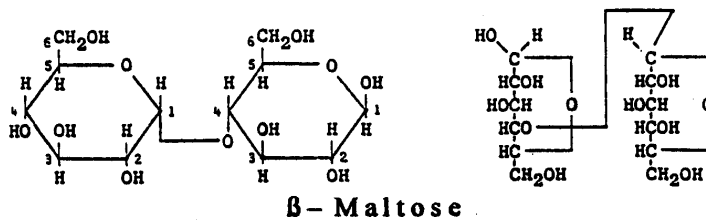

2) Formed by condensation of 2 α -D-glucose linked by α -1,4-glucosidic linkage.

3) Fermentable, reducing, mutarotates and hydrolyzed by maltase.

Lactose: 1) It is milk sugar.

2) Formed by condensation of β -D-galactose with D-glucose linked by β -1,4-galactosidic linkage.

3) Nonfermentable (lactase enzyme is absent from yeast).

4) Reducing, mutarotates and yields galactose and glucose after hydrolysis by lactase enzyme in the intestine.

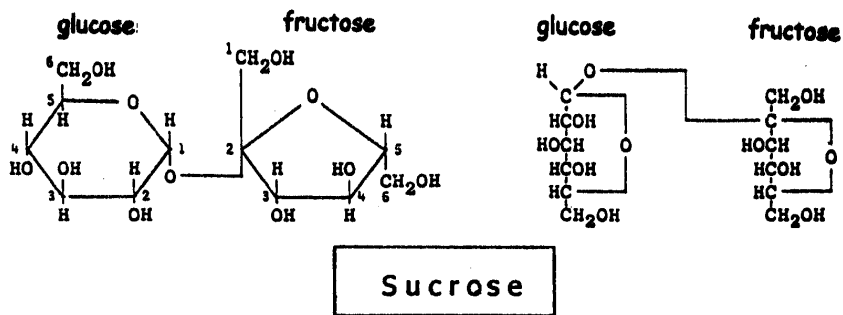
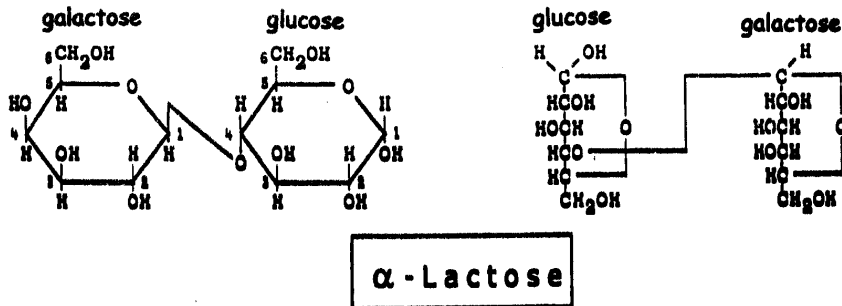

Sucrose:

1) It is cane sugar or beet sugar.

2) Formed by condensation of α -D-glucose with β -D-fructose linked by α -1,2-glucosidic or β -2,1-fructosidic linkage.

3) Fermentable, nonreducing & does not mutarotate.

- 4) **Invert sugar:** sucrose in solution is dextrorotatory but on hydrolysis it gives equal amounts of glucose (+52.5) and fructose (-94). Thus the mixture becomes levorotatory (due to fructose) and sucrose is called invert sugar and the enzyme catalysing hydrolysis is called invertase.

POLYSACCHARIDES

Definition:

- 1) Condensation of n molecules (more than 10) of monosaccharides with the removal of $n-1$ molecules of H_2O through glycosidic linkages.
- 2) They are nonreducing because the carbonyl group of every sugar is blocked by the glycosidic bonds.
- 3) High molecular weight and form colloidal solution in water.

Classification:

A) Homopolysaccharides:

On hydrolysis yield only one type of sugar. Therefore they include: pentosans, glucosans (or dextrans), fructosans (or levans), galactosans (or galactans) mannosans (or mannans) .. etc.

Examples:

1) Starch:

- Glucosan: D-glucose units.
- The storage form of carbohydrates in plants: cereals (wheat & rice), tubers (potatoes & sweet potatoes), legumes (beans).

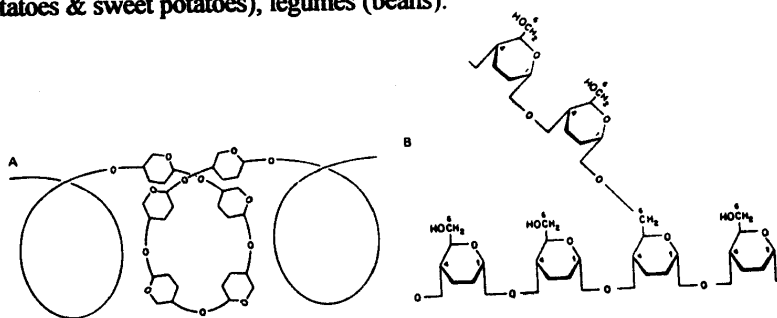

Structure of starch. **A:** Amylose, showing helical coil structure **B:** Amylopectin, showing 1 → 6 branch point.

- Present in the form of granules covered by cellulose layer, soluble in hot water.
- Types. a) **Amylose:** constitute 15-30% of starch granule (inside) & formed of 300-400 sugar units in a nonbranched chain which is coiled like a helix. Glucose units are linked by α -1,4-glucosidic linkage.
- b) **Amylopectin:** on the surface of starch granule & form 70-75% of it. It is a branched chain glucosan. Glucose units are linked by α -1,4-glucosidic linkage in all the branches and by α -1,6-glucosidic linkage at the branching points.

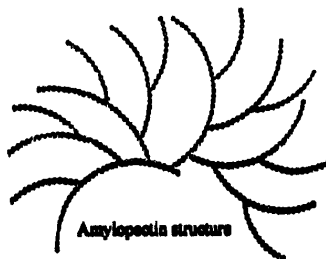

Differences between amylose & amylopectin.

	Amylose	Amylopectin
Glucosan chain	Nounbranched helical	Branched
Glucosidic linkage	α -1,4	α -1,4 & α -1,6
Molecular weight	Low (60000-900000)	High (200000-million)
Solubility in H₂O	More	Less
Iodine test	Blue color	Red color
Amylase digestion	Complete up to maltose	Incomplete & stops at branch points
Acid hydrolysis	Glucose	Glucose

2) Dextrins (amyl-, erythro - & achrodextrins):

- They are obtained after digestion of starch by amylase with the release of maltose units.
- Products of starch digestion are as follows:

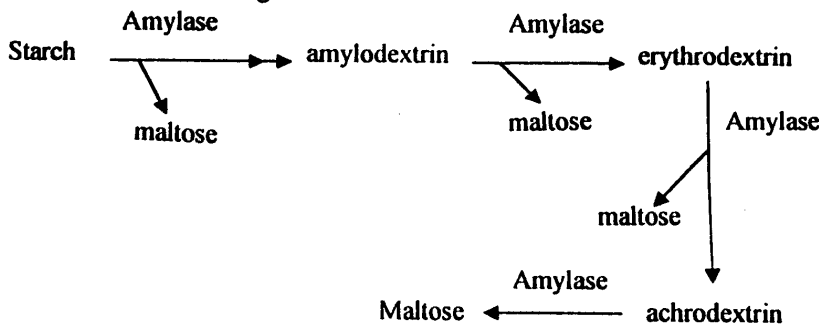

- Iodine gives blue color with starch, violet color with amylo-dextrin, red color with erythro-dextrin and no color with achro-dextrin.
- Starch + dilute acid (HCl) $\xrightarrow{\text{Boiling}}$ glucose.

3) Glycogen:

- Glucosan: D-glucose units.
- The storage form of carbohydrates in animals (mainly liver & muscles).
Branched high molecular weight structure like amylopectin (but with more branches).
- Formed of glucose units linked by α -1,4-glucosidic bonds in the branch and by α -1,6-glucosidic linkage in branching point.
- It is soluble in water and gives red color with iodine.

4) Cellulose:

- Glucosan: D-glucose units.
- The supporting structure of plant tissues (cotton, .. etc.).
- Nonbranched chain formed of cellulose fibers formed of bundles of these chains packed side by side.
- Chains consist of D-glucose units linked by β -1,4-glucosidic linkage (instead

of α -1,4-bonds in starch & glycogen).

- It can be digested by ruminants and herbivorous animals only (not man) by cellulase enzyme produced by microorganisms in their intestine which attacks the β -1,4-glycosidic linkage.
- In man it forms the "bulk" of diet which stimulates intestinal movement.
- It is insoluble in water & gives no color with iodine.

5) Inulin:

- **Fructosan:** D-fructose units. Present in roots of some plants.

Nonbranched chain formed of β -D-fructose units linked by β -1,2-fructosidic linkage.

Used for inulin clearance test (kidney function test).

6) Dextrans:

Glucosan: D-glucose units.

- Highly branched (linkages are: 1,2; 1,3; 1,4; 1,6 glucosidic).
- Used as plasma substitute for raising blood volume.

B) Proteoglycans (protein + glycosaminoglycan):

Definition:

Original name was mucopolysaccharides.

- Made of large complexes of negatively charged carbohydrate chain linked to small amount core protein \rightarrow **proteoglycan monomer**.

Importance:

- They have special ability to bind large amounts of water \rightarrow gel like matrix or ground substance. It is present in: 1) Connective tissues: skin, tendons, ligaments, cartilage. 2) Mucous secretions. 3) Synovial fluids.

Chemical Structure:

1) Carbohydrate component (Glycosaminoglycan or GAG):

of α -1,4-bonds in starch & glycogen).

- It can be digested by ruminants and herbivorous animals only (not man) by cellulase enzyme produced by microorganisms in their intestine which attacks the β -1,4-glycosidic linkage.
- In man it forms the "bulk" of diet which stimulates intestinal movement.
- It is insoluble in water & gives no color with iodine.

5) Inulin:

- Fructosan: D-fructose units. Present in roots of some plants.
Nonbranched chain formed of β -D-fructose units linked by β -1,2-fructosidic linkage.
Used for inulin clearance test (kidney function test).

6) Dextrans:

- Glucosan: D-glucose units.
- Highly branched (linkages are: 1,2; 1,3; 1,4; 1,6 glucosidic).
- Used as plasma substitute for raising blood volume.

B) Proteoglycans (protein + glycosaminoglycan):

Definition:

- Original name was mucopolysaccharides.
- Made of large complexes of negatively charged carbohydrate chain linked to small amount core protein → proteoglycan monomer.

Importance:

- They have special ability to bind large amounts of water → gel like matrix or ground substance: It is present in: 1) Connective tissues: skin, tendons, ligaments, cartilage. 2) Mucous secretions. 3) Synovial fluids.

Chemical Structure:

1) Carbohydrate component (Glycosaminoglycan or GAG):

- GAGs form 95% of proteoglycan.
- Long nonbranched heteropolysaccharide made up of repeating disaccharides formed of:
 - a) Amino sugar (either D-glucosamine GlcN or D-galactosamine GalN).
 - b) Uronic acids (sugar acid): either L-glucuronic (GlcUA), or its 5- epimer L-iduronic (IdUA) acids.
- Amino sugars and uronic acids are sulfated ($-SO_3^-$) except for hyaluronic acid.
- They have strong acidic nature (negatively charged) at physiological pH due to COO^- & $-SO_3^-$ and they tend to repel each other although they are surrounded with H_2O . This leads to the “slippery” consistency observed in mucous secretion, synovial fluid & vitreous humor of the eye.

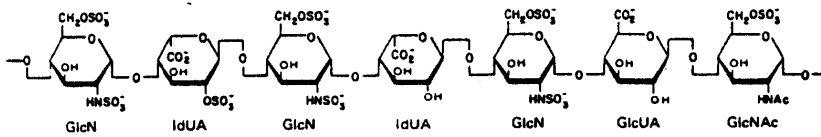

Glycosaminoglycan (GAG) showing a sequence of repeating disaccharide units in addition to sulfated glucosamine residues.

2) Protein component:

GAG + core protein → proteoglycan monomer

- All GAG chains (except hyaluronic acid) are found covalently bound to a core protein forming proteoglycan monomer.

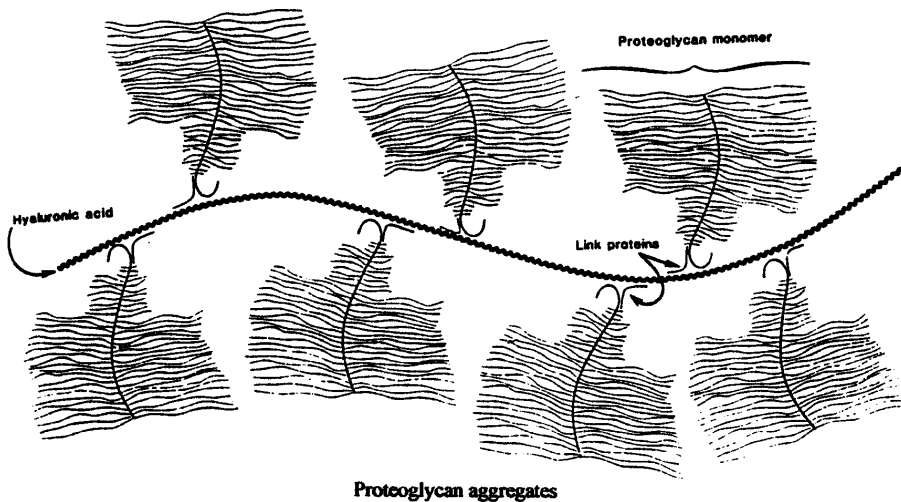

- **Proteoglycan monomer** is synthesized by linking GAG to core protein by glycosidic linkage formed between the OH of serine of protein and xylose of trisaccharide (Gal-Gal-Xyl) present at the end of GAG chain.
- The **“bottle brush” model** of proteoglycan monomer is due to that GAG chains extend out of core protein and remain separated due to repulsion of their large negative charge.
- **Proteoglycan aggregates** are formed by association of many proteoglycan monomers with one molecule of hyaluronic acid. The association occurs between core protein and hyaluronic acid through noncovalent bonds and stabilized by small protein (link protein).

Classification of proteoglycans:

According to proteoglycan monomer composition (GAG + protein), type of glycosidic linkage and presence of sulfate units ($-\text{SO}_3$).

A) Nonsulfated GAG:

Hyaluronic acid:

- Repeated chain of N-acetyl glucosamine (GlcNAC) and β D-glucuronic acid (GlcUA).
- No core protein & not sulfated.
- Highly viscous and serve as lubricant and shock absorbant.
- Site: synovial fluid of joints, vitreous humor of the eye, umbilical cord & loose connective tissues.
- Hyaluronidase enzyme hydrolyzes hyaluronic acid:
 - a) Produced by bacteria to help their spreading in connective tissues (spreading factor).
 - b) Present in excess in sperm head to help penetration of the sperm into ovum (fertilization).

B) Sulfated GAG:

1) Chondroitin sulfate:

- Repeated chain of N-acetylgalactosamine (Gal NAC) and β -D-glucuronic acid (Glc UA).

- **Two types:**

- a) Chondroitin - 4-sulfate = $-\text{SO}_3$ at C_4 of Gal NAC.

- b) Chondroitin - 6-sulfate = $-\text{SO}_3$ at C_6 of Gal NAC.

- With core protein \rightarrow proteoglycan monomer & aggregates.

- Site: It is the most abundant. Present in cartilage, bone, heart valves, sclera & cornea of the eye & connective tissues

- 2) Dermatan sulfate:**

- Similar in structure to chondroitin sulfate except that iduronic acid IdUA is present instead of Glc UA.

- Site: connective tissues, blood vessels & heart valves.

- 3) Keratan sulfate:**

- Repeating units of N-acetylglucosamine and galactose.

- Sulfated and form proteoglycan aggregates.

- Site: cartilage (with chondroitin sulfate), cornea & bone.

- 4) Heparin:**

- Repeating units of glucosamine (GlcN) & glucuronic acid (GlcUA).

- Sulfated on most GlcN residues & form proteoglycan monomer.

- Site: It is an anticoagulant synthesized by mast cells that line arteries. It is also present in liver, lung and skin.

- 5) Heparan sulfate:**

- Similar to heparin except that some GlcN is acetylated.

- It is less sulfated than heparin & form proteoglycan aggregates.

- Site: basement membrane and cell surfaces.

Site of synthesis of GAG & proteoglycans:

Steps of proteoglycan synthesis:

- 1) Proteins are synthesized on the endoplasmic reticulum (ER).

- 2) Addition of sugar units to core protein in ER & Golgi complex.
- 3) Addition of sulfates to sugar → proteoglycan monomer.
- 4) Proteoglycan associate with hyaluronic acid and form proteoglycan aggregates which are secreted from the cell (extracellular matrix).

Degradation of GAG & proteoglycans:

Proteoglycans are transported from extracellular matrix to inside cells by endocytosis. Inside cells they fuse with lysosomes and are degraded by two types of hydrolytic enzymes:

- a) Acid hydrolases remove sugar units from core protein.
- b) Sulfatases remove $-SO_3$ groups from the sugar.
- c) Proteases hydrolyse core protein to am. ac.

Mucopolysaccharidosis:

- A disease due to deficiency of one of the lysosomal enzymes normally involved in GAG & proteoglycan degradation.
- There is accumulation of various GAGs in tissues and oligosaccharides appear in urine of patients.
- Diagnosis: by measurement of lysosomal enzymes in tissues.
- Manifestations: bone deformities & deformed facial features.

GLYCOPROTEINS

Definition:

Proteins to which few branched oligosaccharides are covalently bound. They are found extracellularly and on cell membranes.

Function:

Enzymes, hormones (chorionic gonadotrophin), antibodies, blood group antigens on RBCs, mucin of gastrointestinal tract, cell receptors.

Differences between glycoproteins & proteoglycans:

- 1) Short oligosaccharide chain (2-10 units).

- 2) Branched carbohydrate chain.
- 3) Do not contain uronic acids.
- 4) Higher protein/carbohydrate ratio.

Structure:

A) Carbohydrate component:

- Short branched oligosaccharide chain made of heteropolymers of mainly mannose & galactose in addition to N-acetylgalactosamine, N-acetylglucosamine & N-acetylneuraminic acid or sialic acid (NANA).

B) Attachment of carbohydrate to protein:

By two glycosidic linkages:

- 1) O-linkage: between -OH of serine & sugar.
- 2) N-linkage: between -N of amide group of asparagine (amino acid) and sugar.

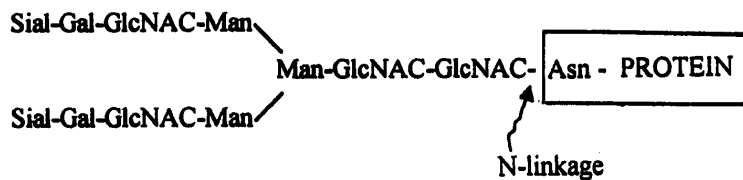
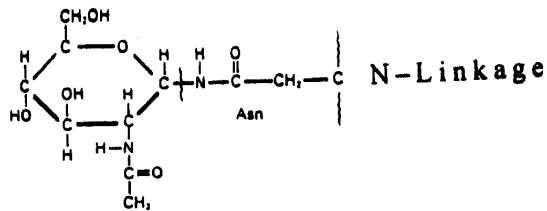
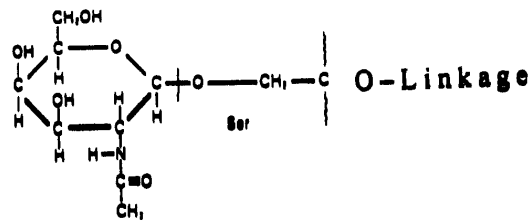

Structure of glycoprotein: Asn = Asparagine; GlcNAC = N-acetylglucosamine;
 Man = Mannose; Gal = Galactose; Sial = Sialic acid (NANA).

Synthesis and degradation:

Similar to GAG and proteoglycans.

Glycoprotein storage diseases:

Due to deficiency of one of the lysosomal enzymes involved in glycoprotein degradation leading to accumulation of oligosaccharides and glycoproteins in cells.

GLYCOLIPIDS (Glycosphingolipids)

Definition:

Sugars attached to **ceramide** (fatty acid + sphingosine).

Examples:

A) Cerebrosides:

Glc or Gal + Ceramide

B) Gangliosides:

Glc, Gal, Sialic acid + Ceramide

Please refer to lipids for details.

Differences between proteoglycans, glycoproteins & glycolipids.

	Proteoglycans	Glycoproteins	Glycolipids
<u>General structure:</u>	95% carbohyd. 5% protein	5% carbohyd. 95% protein	10% carbohyd. 90% lipid.
<u>Carbohydrate:</u>			
a) Chain	Long nonbranched	Short branched	Very short non-branched (cerebrosides) & branched (gangliosides)
b) Sugar residues	Of GAG: aminosugars and uronic acids	Man, Gal, Glc, aminosugars and sialic acid	- Cerebrosides (Glc or Gal) - Gangliosides (Glc, Gal, Sialic acid)
c) Attachment to protein/ lipid	- OH of serine (O-linkage)	- OH of serine (O-linkage) and - N of asparagine (N-linkage)	- OH group of sphingosine base
d) Sulfate group.	Present (except hyaluronic acid)	Absent	Present in cerebrosides (sulfatids)
<u>Distribution</u>	Extracellular matrix (bone, cartilage, connective tissues, synov. membrane, umbilical cord, vitreous humor etc).	Enz., hormones, antibodies, cell membranes, blood group antigens, cell receptors, mucous secretions.	Cell membranes

LIPIDS

Definition:

Nonpolar (nonionized) hydrophobic molecules that are insoluble in water and soluble in fat solvents (ether, benzene & chloroform). They are quite heterogeneous structure of fatty acids, glycerol, sphingosine and sterols.

Importance:

- 1) Source of energy: lipids give more heat per gram than carbohydrates when burned.
- 2) Can be stored in the body in an unlimited amount.
- 3) Act as thermal & electrical insulator.
- 4) Provide padding to protect internal organs.
- 5) Enter into structure of all membranes.
- 6) Degradation of fatty acids yield acetate which is the building blocks of cholesterol and steroid hormones.
- 7) Dietary lipids supply essential fatty acids.

Classification:

- A) Simple lipids: neutral fat & waxes.
- B) Compound lipids: phospholipids, glycolipids & lipoproteins.
- C) Derived lipids: after hydrolysis of the above groups (fatty acids, glycerol, alcohols, steroids, carotenoids, fat soluble vitamins, ketone bodies).

FATTY ACIDS

Definition:

Aliphatic carboxylic acids which mostly have straight chain and even number of carbon atoms (odd numbered and branched chain fatty acids occur in human sebum of external ear). They might be saturated or unsaturated (with one or more double bonds).

Numbering of carbon atoms:

They are numbered from carboxyl carbon (C_1), next carbon is C_2 or α carbon, C_3 is the β carbon & the end methyl carbon is ω carbon

(ω = omega).

Numbering and position of double bonds:

- 1) Δ^9 = double bond between C_9 and C_{10} . (Δ = delta).
- 2) ω^9 = double bond on C_9 counting from the ω carbon.
- 3) 16:1 = fatty acid with 16 carbon atoms : one double bond.
18:1 = fatty acid with 18 carbon atoms : one double bond.
18:2 = fatty acid with 18 carbon atoms : 2 double bonds.

Classification of fatty acids:**A) Saturated FA:**

- The simplest is acetic acid (2 carbons) and $-CH_2-$ is progressively added between terminal CH_3 & $COOH$ groups.

- **Include:**

1) Acetic	CH_3COOH	2 carbons
2) Butyric	$CH_3-CH_2-CH_2-COOH$	4 carbons
3) Caproic	$CH_3-CH_2-CH_2-COOH-CH_2$	6 carbons
4) Caprylic	$CH_3-(CH_2)_6-COOH$	8 carbons
5) Capric	$CH_3-(CH_2)_8-COOH$	10 carbons
6) Lauric	$CH_3-(CH_2)_{10}-COOH$	12 carbons
7) Myrestic	$CH_3-(CH_2)_{12}-COOH$	14 carbons
8) Palmitic	$CH_3-(CH_2)_{14}-COOH$	16 carbons
9) Stearic	$CH_3-(CH_2)_{16}-COOH$	18 carbons
10) Arachidic	$CH_3-(CH_2)_{18}-COOH$	20 carbons
11) Behenic	$CH_3-(CH_2)_{20}-COOH$	22 carbons
12) Lignoceric	$CH_3-(CH_2)_{22}-COOH$	24 carbons

- Sources:

- 1) Palmitic and stearic: in all animals & plants.
- 2) Caprylic, capric, lauric, myristic, arashidic: in plants (coconut, peanut, nutmeg).
- 3) Lignoceric; in cerebrosides (glycolipid).

B) Unsaturated FA:

These are FA with one or more double bonds. Polyunsaturated FA cannot be synthesized in the body so they are essential FA.

1) Monoethenoid (one double bond): Nonessential

- a) Palmitoleic (16:1, Δ^9 , $\omega 7$).

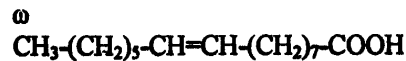

Occurrence: all fats.

- b) Oleic (18:1, Δ^9 , $\omega 9$)

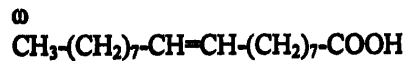

Occurrence: Most common FA in natural fat.

- c) Nervonic (24:1, Δ^{15} , $\omega 9$)

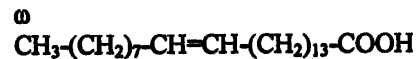

Occurrence: In cerebrosides (glycolipid).

2) Polyethenoid (polyunsaturated): Essential

- a) Linoleic: two double bonds (18:2, $\Delta^{9,12}$, $\omega 6$)

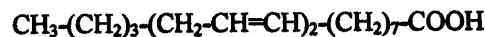

Occurrence: corn, peanut, cotton seed, soyabean.

- b) Linolenic: three double bonds (18:3, $\Delta^{9,12,15}$, $\omega 3$)



Occurrence: plant oils (with linoleic acid).

- c) Arachidonic: four double bonds (20:4, $\Delta^{5,8,11,14}$, $\omega 6$)

Occurrence: plant oils (with linoleic) & in phospholipids in animals.

d) Clupanodonic: five double bonds (22:5, $\Delta^{7,10,13,16,19}$, $\omega 3$)

Occurrence: fish oil & phospholipids of brain.

3) Eicosanoids:

- Derived from eicosanoic polyethenoic FA (C20).

- Eicosanoic is a C20 molecule derived from arachidonic acid (C20) after cyclization of the center of the carbon chain to form a ring.

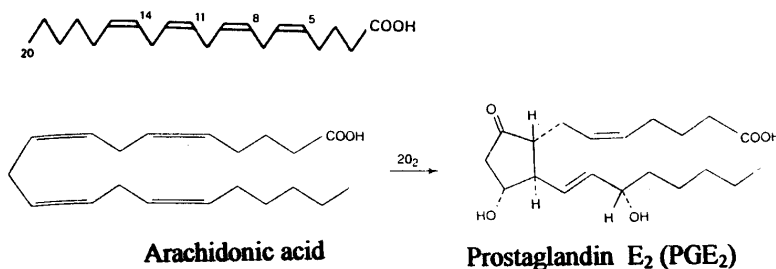

- They are synthesized by all tissues.

- Examples:

- a) Prostaglandins (PGA, B, D, E, F, G, H, I): It has a hormone like action but act locally. They produce vasodilatation, contraction of smooth muscle of the uterus and intestine.
- b) Leukotriens: in platelets, leucocytes and mast cells. Mainly involved in chemotaxis.
- c) Thromboxanes: stimulate platelet aggregation.
- d) Prostacylins: vasodilators & inhibit platelet aggregation.

Geometric isomerism of FA (Cis & Trans configuration)

- Occurs in unsaturated fatty acids.

- Due to orientation of atoms around the axis of double bond (Cis & Trans isomers)

a) Cis: if the groups are on the same side of the bond.

b) Trans: if the groups are on the opposite side of the bond.

- Most naturally occurring unsaturated FA are in Cis configuration and the FA being kinked at the double bond. More double bonds lead to more kinks in FA (arachidonic acid has several kinks → u shape).

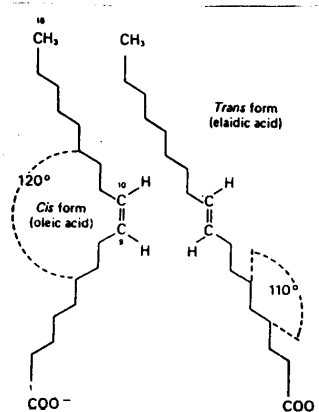

Geometric isomerism of unsaturated FA (oleic & elaidic) (Cis & Trans configuration).

- FA with Trans double bonds tend to have higher melting point.
- Hydrogenation of oil will change Cis to Trans during manufacture of margarine (solid at room temperature).
- Cis configuration allow for more fluidity of membrane lipid bilayer due to their kinks.

Physical properties of FA:

- 1) Solubility: Insoluble in water but soluble in fat solvents (ether, benzene & chloroform). However, short chain FA are soluble in H₂O.
- 2) Melting points: Depends on the chain length & the presence of double bonds.
 - It decreases with decreasing length of the chain & with increasing number of double bonds (Cis bonds).
 - At room temperature palmitic and stearic acids are solid (long chain & saturated) while linoleic and lenolenic acids are liquid (unsaturated).

3) Color, odor & taste:

- Short chain FA: colorless, irritating odor & sour taste.
- Long chain FA: colorless, odorless & tasteless.

Chemical properties of FA:**A) Due to carboxyl group:****1) Salt formation (soaps):**

- Long chain FA + Alkalie $\xrightarrow{\text{Na \& KOH}}$ alkaline salt (soap).

- Sodium and potassium soaps are soluble in water (soft soap) because soaps are amphipathic salts of FA and form micelles in water (used as emulsifying agents).
- Soaps of calcium & magnesium are insoluble in water. Therefore hard water (containing Ca & Mg salts) precipitates soaps which will lose its emulsifying character.

2) Esterification:

- FA with glycerol form triacylglycerol (neutral fat).
- FA with higher alcohols form waxes (neutral fat).

3) Reduction:

- COOH of FA is reduced to aldehyde (R-CHO) then further reduced to fatty alcohol (R.CH₂.OH).

B) Due to double bonds:

1) Hydrogenation: by addition of 2H per double bond forming solid saturated FA (oleic form stearic).

2) Halogenation: by addition of I or Br per double bond forming iodo- or bromoderivatives.

3) Oxidation: by addition of 2O₂ per double bond forming FA peroxides which are unstable and break readily into shorter chain aldehydes, alcohols and

ketones. It is the basis of auto-oxidation of FA which is responsible for rancidity of fats.

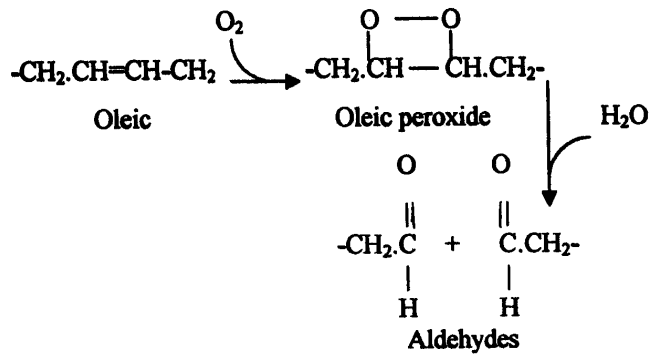

ALCOHOLS

Examples:

Glycerol, cholesterol, higher alcohol (cetyl alcohol in waxes).

Glycerol:

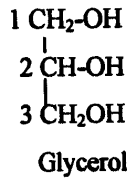

- Trihydric alcohol that form esters with FA.
- Soluble in water (hygroscopic) and insoluble in fat solvents.
- Acrolein test: If glycerol is heated with sulfuric acid it gives an aldehyde which has an irritating odor (acrolein). It is used as a test for neutral fat.

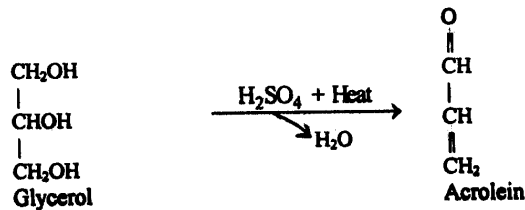

NEUTRAL FATS (Triacylglycerols)

Definition:

Esters of glycerol and 3FA (mostly mixed).

Examples:

- 1) Fat: Solid, rich in saturated FA, animal source (butter, lard & mutton), plant source (margarine).
- 2) Oils: Liquid, rich in unsaturated FA, plant source (cotton seed oil, olive oil, linseed oil, soyabean oil, coconut oil, castor oil, maize oil), animal source (codliver oil rich in vitamins A & D).

Structure:

- Naturally occurring triacylglycerols (TG) are nearly all mixed (3 different FA are attached to 3 ester positions).

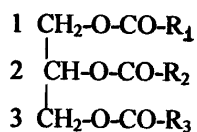

Triacylglycerol

- C₁ & C₃ of glycerol are not identical when viewed in 3 dimensions. Enzymes can readily distinguish between them and always specific for one or the other carbon. Glycerolkinase enzyme always phosphorylate C₃ of glycerol → glycerol 3 phosphate.

Physical properties:

- 1) Solubility: insoluble in water & soluble in fat solvents.
- 2) Melting point: solid (if rich in saturated FA) & oil (if rich in unsat. FA).
- 3) Colorless, tasteless & odourless (carotenoids give yellowish color to human adipose tissues, Cow's milk and butter).
- 4) Specific gravity: TG float on water (less than sp. gravity of water).

Chemical properties:

- 1) **Acrolein test:** TG give +ve test due to glycerol.
- 2) **Hydrogenation & hardening:** TG add H to unsaturated FA in presence of Nickel as a catalyst forming saturated FA. It is used commercially to prepare hard fat from oil (margarine).
- 3) **Halogenation:** TG add I or Br to its unsaturated FA.
- 4) **Hydrolysis:**
 - a) Lipase enzyme: → FA + glycerol.
 - b) Acid hydrolysis + boiling → FA + glycerol.
 - c) Alkalie hydrolysis + boiling → soap.
- 5) **Rancidity:** It is the bad flavour (taste and odour) of fat when exposed to moisture, light, oxygen & warmth.

Types:

- a) **Hydrolytic:** occurs in butter due to its content of water and hydrolysis of TG by bacterial enz. into short chain FA and bad flavour results.
- b) **Oxidative:** occurs in fat rich in unsaturated FA which are oxidized at the double bonds forming peroxides, fatty aldehydes, acids and alcohols and bad flavour results.
- c) **Ketonic:** Fungi produce ketones of bad flavour.

Detection:

By the change in flavour (taste & odour), increase in acid number of fat & positive copper acetate test.

Prevention:

- a) Addition of antioxidants to fat (Vit E and phenols).
- b) Avoid light, moisture, O₂ & heat.

6) Oxygenation & drying & hardening:

Oils rich in unsaturated FA rapidly dry out when exposed to atmospheric oxygen because these acids break into short chain aldehydes, ketones, alcohols and acids. These oils (linseed oil) are used for painting.

Fat analysis and constants:

Chemical analysis of fats showed that they had certain constants for every type. These constants change if the fat is altered by adulteration or rancidity.

1) Saponification number:

- The number of mg of KOH necessary to combine with all the fatty acids present in 1 g of fat.
- High numbers are given with fat rich in short chain FA.
- Butter has high number.

2) Iodine number:

- The number of iodine necessary to saturate the unsaturated fatty acids in 100 g of fat.
- Higher number in oils than fat.

3) Acid number:

- The number of mg of KOH necessary to neutralize the free fatty acids in 1 g of fat.
- High number in rancid fat.

4) Acetyl number:

- The number of mg of KOH necessary to neutralize acetic acid liberated from hydrolysis of 1 g of acetylated fat or oil.
- It measures the hydroxy FA in fats (high in castor oil).
- Generally TG have low number.

WAXES

Definition:

Esters of fatty acids with alcohols of higher molecular weight than glycerol.

Examples:

1) Cholesterol wax (cholesteryl palmitate or stearate):

- Large amount in blood and small amount in tissues.

- Lanoline is the cholesterol ester that form a water proof coat on the wool fibers of fur-bearing animals.

2) Bee wax is the ester of myricyl alcohol (C₃₀) with palmitic acid.

Differences between waxes & TG:

1) Contain alcohols with high molecular weight.

2) Acrolein test is negative.

3) Always solid at room temperature (High melting point).

4) Do not become rancid.

5) Not digested by lipase.

PHOSPHOLIPIDS

Definition:

Conjugated lipid formed of lipids (FA + alcohol) attached to them phosphate radical.

Two types:

A) Phosphoglycerides:

- Formed of: glycerol + FA + phosphate + alcohol.

- Include: i) phosphatidic acid ii) lecithins iii) cephalins iv) lipositol v) cardiolipin vi) plasmalogens.

B) Sphingomyelin:

- Formed of: Sphingosine + FA + phosphate + alcohol.

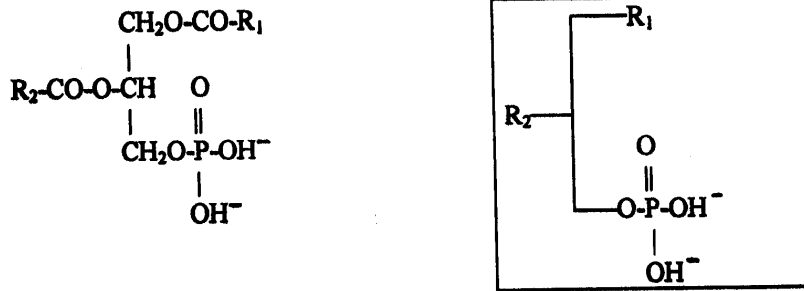
1) Phosphatidic acid (Diacylglycerol phosphate):

- Phosphatidic acid is the precursor of the other phosphoglycerides.
- 2 FA, one saturated and another unsaturated, form ester bonds with C₁ and C₂ of glycerol, respectively.
- Phosphate radical form ester bond with C₃ of glycerol.
- It is not present free in tissues and it functions as an intermediate in TG synthesis.

2) Cardiolipin (Diphosphatidylglycerol):

- Formed of 2 phosphatidic acids linked together by glycerol.
- It is present in mitochondrial membranes.
- It is the only human phosphoglyceride that is antigenic.

3) Lecithins (Phosphatidylcholine):

- Formed of phosphatidic acid attached to it choline through ester bond with the phosphate group.

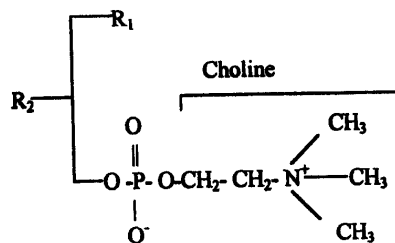

- Present in excess amount in cell membranes & egg yolk.
- Soluble in fat solvents & form colloidal solution with H₂O.
- Dipalmitoyl lecithin is present in excess in extracellular fluid that lines the lung alveoli. It act as a **surfactant** that lowers the surface tension of this fluid layer which prevent alveolar collapse.
- **Respiratory distress syndrome** (Hyaline Membrane disease): infants born deficient in surfactant will die from respiratory failure due to collapse of lung alveoli. They are treated by surfactants.
- **Lecithinase enzyme** of snake venom will transform lecithin into **Lysolecithin** (without FA at C₂ of glycerol) which lead to hemolysis of red blood cells after a snake bite.

4) Cephalins:

- They are phosphatidyl serine & phosphatidylethanolamine.

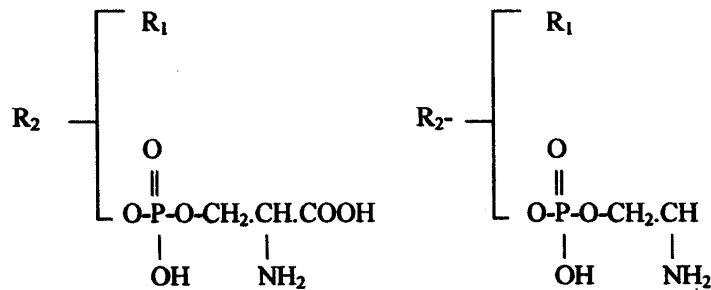

Phosphatidyl serine

Phosphatidylethanolamine

- They have either serine or ethanolamine base.
- Present in cell membranes, blood, nervous tissues and liver.
- Soluble in fat solvents, insoluble in alcohol and form emulsion with water.
- It accelerates blood coagulation.
- Lysocephalins are also produced by snake venom (similar to lysolecithin).

5) Lipositol (phosphatidylinositol):

- Formed of phosphatidic acid and inositol

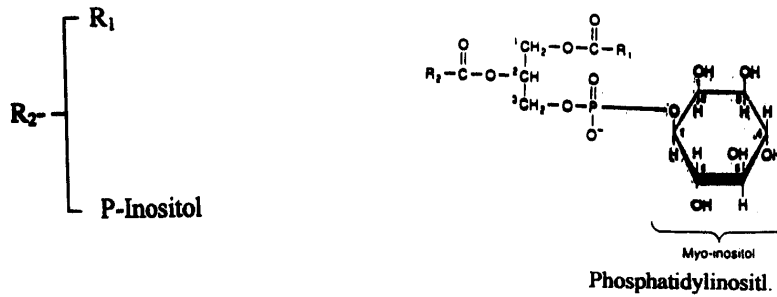

- The 2FA are stearic on C₁ and arachidonic on C₂.
- Important constituent of cell membranes.
- Phosphatidylinositol 4,5-bisphosphate (PIP₂) is involved in the mechanism of hormone action (class II hormones). Binding of the hormone to its receptor will activate phospholipase C which catalyses the breakdown of PIP₂ into diacylglycerol and inositol triphosphate (IP₃). IP₃ increases the release of calcium from intracellular stores. Calcium will mediate the hormone action inside cells (second messenger).

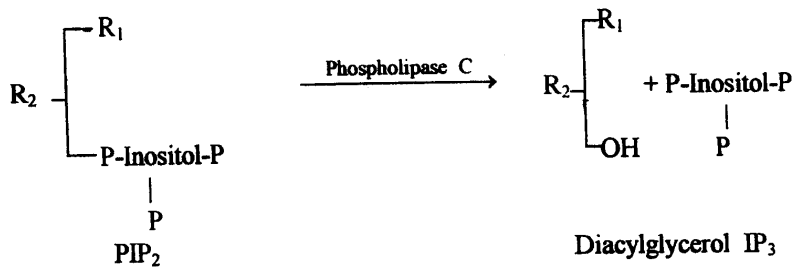
**6) Plasmalogens (Phosphatidyl ethanolamine):**

- Structure is similar to lecithins & cephalins (contain either choline, serine or ethanolamine) except that R₁ is attached to C₁ of glycerol by an ether linkage.

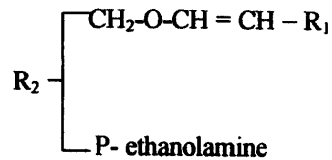

- Constitutes 10% of phospholipids of brain & muscles.

7) Sphingomyelin:

- Formed of sphingosine + FA + phosphate + choline

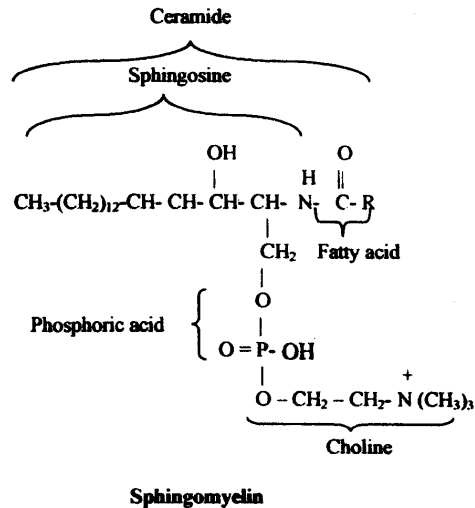

- Sphingomyelin contains instead of glycerol an amino alcohol, sphingosine.
- Ceramide = FA + sphingosine.
- Ceramide is present in sphingomyelin & glycosphingolipids.
- Sphingomyelin occur in brain and nervous tissues.
- Nieman - Pick disease: Accumulation of sphingomyelin in liver, spleen & brain due to absence of sphingomyelinase.

Amphipathic property of phospholipids:

A) phospholipids have two groups:

- 1) Polar group: phosphate, choline, serine, ethanolamine and inositol. This group is soluble in H₂O.
- 2) Nonpolar group: FA which are soluble in fat solvents.

B) If added to water the polar and nonpolar groups will arrange themselves in several ways:

- 1) **Micelles:** The polar group (hydrophilic) will project out towards the aqueous phase while the nonpolar group (hydrophobic) will dip into the center of the micelle away from water.
- 2) **Liposomes:** These are spheres of lipid bilayer where aqueous phase is present both outside and in the center of the liposome.
- 3) **Emulsions:** Amphipathic molecules (phospholipids & bile salts) when added to water containing oil and the mixture is shaken vigorously, an emulsion is formed. This is because amphipathic molecules will arrange themselves around oil droplets in a micelle like manner so that oil droplets become negatively charged and repel each other and become emulsified.

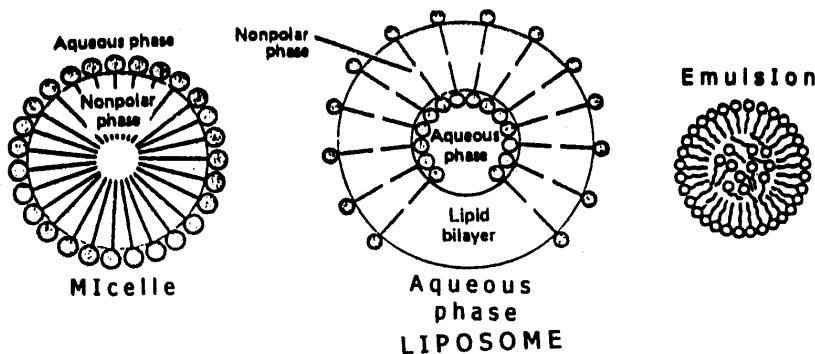

Importance of phospholipids:

- 1) **Lecithin:** Is abundant in cell membranes. Also it is present in extracellular fluid of lung alveoli and act as surfactant to prevent collapse of the lung.
- 2) **Phosphatidyl inositol** act as second messenger for hormone action.
- 3) **Cephalins** accelerate blood clotting.
- 4) **Cardiolipins** are in mitochondrial membranes and is used for serologic diagnosis of syphilis.
- 5) **Form the lipid bilayer** of membranes.
- 6) **Act as detergents** in the intestine. In addition to bile salts they form micelles when mixed with the digestive products of fat in order to facilitate fat absorption from intestine.

SPHINGOLIPIDS

Definition:

All lipids which contain sphingosine base.

Examples:

A) Ceramide = sphingosine base + FA.

B) Sphingomyelin = Ceramide + P + choline.

C) Glycosphingolipids (glycolipids):

1) Cerebrosides = Ceramide + monosaccharide (Gal, Glc).

2) Gangliosides = Ceramide + 2-3 Gal or Glc.
+ 1-5 molecules of sialic acid (NANA).
+ amino sugars (Gal NAC).

3) Sulfolipids = Cerebroside + sulfate.

Ceramide:

- The simplest sphingolipid (sphingosine + FA).

- It is the core on which other sphingolipids are formed.

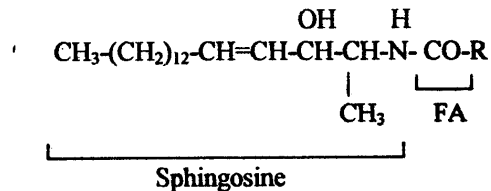

Sphingomyelin:

- Ceramide + P + choline

(Please refer to phospholipids).

Cerebroside:

- It is a glycosphingolipid (glycolipid).

- Formed of ceramide + Gal (the most common cerebroside in membranes) or Glc.

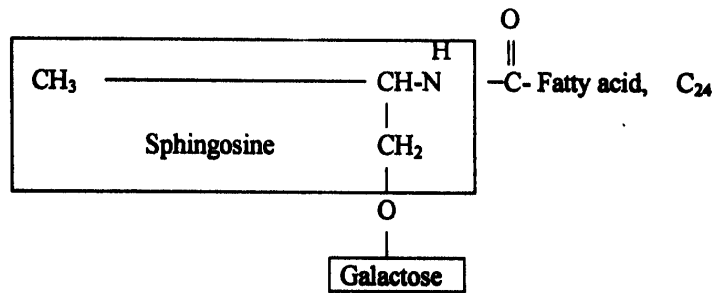

- FAs are lignoceric (C_{24}) or its derivative (Nervonic, cerebronic).
- FA is linked to NH_2 of sphingosine by amide linkage & sphingosine is linked to Gal by galactosydic linkage.
- **Three types that differ in FA content are found:**
 - a) **Nervon:** Contains nervonic acid (unsaturated, C_{24}).
 - b) **Cerebron:** Contains cerebronic acid (hydroxy FA, C_{24}).
 - c) **Kerasin:** Contains lignoceric acid (saturated FA, C_{24}).
- Found mainly in the brain & nervous tissues with high concentration in myelin sheath.
- Gaucher 's disease: Accumulation of cerebroside in liver, spleen and brain due to absence of cerebrosidease enzyme.

Gangliosides:

- It is a glycosphingolipid (glycolipid).
- They are the most complex glycolipid.
- Formed of: Ceramide + oligosaccharide that contain Glc, Gal, amino sugar (Gal NAC) & sialic acid (NANA).

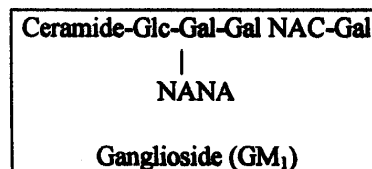
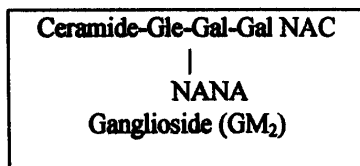

- The presence of NANA makes gangliosides highly acidic and acquire negative charge at physiological pH.

- **Types:** According to the number of sialic acid (NANA) in the ganglioside (G). There are GM (one NANA), GD (two NANA) and GT (three NANA). GM subgroups are GM₁, GM₂, GM₃ and indicate carbohydrate sequence (1 = Gal-GalNAC-Gal-Glc-Ceramide; 2 = GalNAC-Gal-Glc-Ceramide; 3 = Gal-Glc-Ceramide).

- **Importance:**

- 1) Highly concentrated in ganglion cells of central nervous system particularly nerve endings. Lesser amount (10% of G) are present on the surface of cells.
- 2) They bind cholera toxins to intestinal mucosal cells (GM₁). The toxin causes diarrhea and may be death.
- 3) They are receptors to toxins (virus, tetanus).
- 4) Mediate cell-cell recognition.
- 5) Act as tumor marker on the surface of tumor cells.

- **Gangliosidosis (Tay-Sachs disease).**

- 1) Accumulation of gangliosides in brain & viscera due to absence of β -galactosidase enzyme which degrade gangliosides.
- 2) Mental retardation, hepatosplenomegaly and death within the first year of life.

Sulfolipids (Sulfatides):

- Formed of cerebroside + sulfate group.
- Sulfate group is attached to galactose.
- Found in the brain (the major source of sulfur in the brain).

LIPOPROTEINS

Definition: Complexes of lipids and proteins (apoprotein). Lipid part consists of TG, cholesterol, cholesterol esters, phospholipids and very little free FA

Introduction:

- Lipids are transported in blood as lipoproteins.
- Lipids are insoluble in water. Therefore nonpolar lipids (TG & cholesterol esters) are associated with amphipathic lipids (phospholipids and cholesterol) and protein in order to keep lipids soluble as they transport them in an aqueous medium like blood. This will easily transport lipids to tissues.

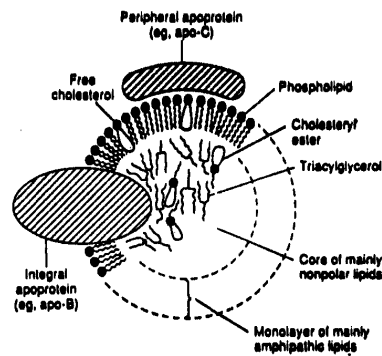
General structure:

**General structure of lipoprotein.
The similarities with the organization of plasma membrane are to be considered.**

- It has a general structure similar to that of membranes.
- A typical lipoprotein consists of (Refer to the figure):
 - 1) Lipid core made of TG & cholesterol esters (Nonpolar & hydrophobic).
 - 2) Outer surface made of a single layer of phospholipids and cholesterol (polar & amphipathic) oriented so that their polar groups face the aqueous medium.
 - 3) Protein part (apoprotein) either traverse the lipid layer (integral protein) or loosely attached to the surface of lipid part (free to transfer to other lipoprotein).

Classification of Plasma Lipoproteins:**A) By ultracentrifugation:**

Principle:

- 1) Fat is less dense than water and the addition of protein to fat will increase its density.
- 2) Ultracentrifugation of lipoproteins in a solution of NaCl (specific gravity 1.063) will make them float at a certain distance from the bottom of solution according to the density of each class.

Classes:

- 1) Chylomicrons (CM): Derived from intestinal absorption of TG. It is the lowest in density & largest lipoprotein.
- 2) VLDL (very low density lipoprotein): Derived from liver and transport TG to peripheral tissues.
- 3) LDL (low density lipoprotein): VLDL is transformed to LDL and the later is used by tissues through their receptors (LDL receptors).
- 4) HDL (High density lipoprotein): formed in the liver and is used to carry lipids from blood & tissues back to the liver.

B) By electrophoresis:

Principle:

Lipoproteins migrate in an electric field depending on their charge. Alfa migrate faster than β -lipoproteins.

Classes:

- 1) Chylomicrons (CM): Do not migrate in the electric field.
- 2) α -Lipoproteins : HDL.
- 3) Pre β - lipoproteins : VLDL.
- 4) β - lipoproteins : LDL.

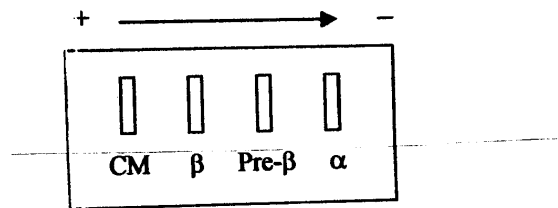

Plasma lipoprotein electrophoresis (electrophoretic bands).

Chemical composition of plasma lipoproteins.

Class	Protein (%)	Total lipid (%)	% of total lipid					Apoprotein
			TG	PL	CE	C	FF	
Chylomicrons	1	99	88	8	3	1	-	A, B-48, C
VLDL	8	92	56	20	15	8	1	B-100, C, E
LDL	20	80	14	26	48	10	2	B-100
HDL	33	67	15	44	31	10	-	A, C, E, & D

TG = triacylglycerol; PL = phospholipids; CE = cholesterol ester; C = cholesterol; FF = free FA.

A) Lipid part:

- 1) Chylomicrons: Highest content of lipids (mostly TG) and lowest content of protein (1%).
- 2) VLDL: TG content decreases compared to that of CM. However, VLDL contains higher amount of TG than LDL & HDL.
- 3) LDL: contains the highest amount of CE.
- 4) HDL: contains the highest amount of phospholipids & protein.

B) Protein part:

- 1) Apo proteins A, B, C, D & E.
- 2) Apo B is of 2 types: a) Apo B-48 is in chylomicrons & synthesized in the intestine b) Apo B-100 is in VLDL & LDL, synthesized in the liver and is larger than Apo B-48 (It is the longest single polypeptide known).
- 3) CM has the lowest and HDL the highest amount of protein.
- 4) Apo C.
- 5) Function: provide solubility to lipids & recognition site for LDL receptors on cells and serve as cofactors for enzymes involved in lipoprotein metabolism.

STEROIDS

Definition:

Compounds that have C_{17} cyclic nucleus (cyclopentanoperhydrophenanthrene).

General Structure:

The nucleus is formed of 4 rings (A, B, C & D):

- 1) Have $-CH_3$ group at C_{10} & C_{13} .
- 2) Have side chain at C_{17} .
- 3) Have $-OH$ or $=O$ at C_3 .
- 4) C & D rings are always saturated but rings A & B may contain a double bond.
- 5) **Sterols** are steroids that have one or more $-OH$ group and no carbonyl or carboxyl groups.

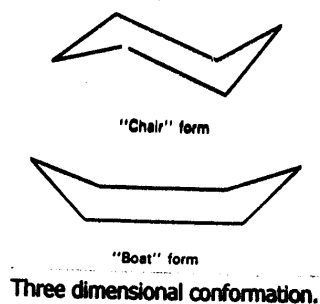
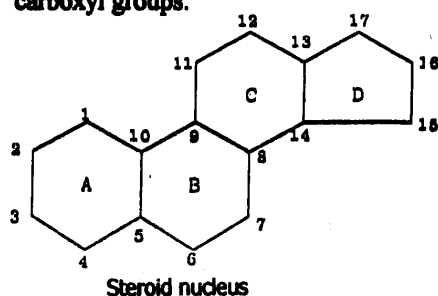

Stereoisomerism:

- 1) Rings exist in 3 dimensional conformation either of **chair** or **boat** form.
- 2) According to the junction between rings they can have **Cis** or **Trans** conformation.
- 3) Naturally occurring steroids have the more stable **chair** form.

Examples:

- A) Sterols: i) Phytosterols (sitosterol in corn, wheat & soyabeans). ii) Mycoesterol (ergosterol in algae & fungi & precursor of vit D_2). iii) Zoosterol (cholesterol in animals).

B) Bile acids:**C) Steroid hormones.****Cholesterol:**

- It has a double bond between C₅-C₆ and 8 membered branched hydrocarbon side chain at C₁₇.

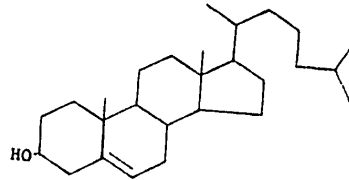

Cholesterol

- **Very hydrophobic** (due to side chain), insoluble in water & soluble in fat solvents.
- **Widely distributed in animal tissues:** cell membranes, blood plasma, brain, egg yolk, adrenal cortex, gonads, liver, bile & kidney.
- **In blood** it is either free or in ester form with FA at -OH of C₃. Cholesterol esters are more hydrophobic than free cholesterol. Therefore cholesterol and cholesterol esters must be transported in association with proteins (lipoprotein) or solubilized in bile.
- **Blood level** = 150-250 mg% which originate from both endogenous (synthesis) or exogenous (diet) sources.
- **Derivatives:** bile acids, steroid hormones, vit D₃.
- Vit D₃ formation.

Cholesterol in liver → 7 dehydrocholesterol → by exposure to UV light → Cholecalciferol (Vit D₃)

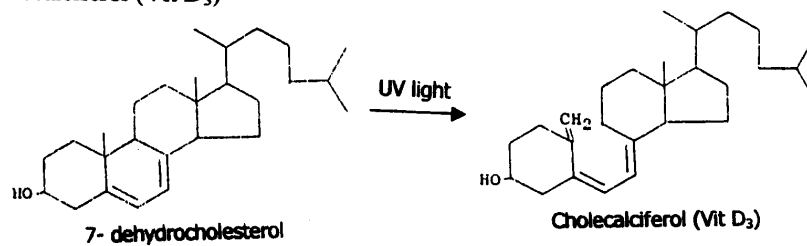

Bile Acids:

- 1) Synthesized in the liver from cholesterol by several hydroxylation & oxidation reduction reactions.
- 2) Bile acids have one or more -OH groups and the side chain is shortened and acquire -COO⁻ group at its end.
- 3) Primary bile acids are cholic and chenodeoxycholic acids.
- 4) Secondary bile acids are derived from primary acids after removal of -OH groups by intestinal bacteria (deoxycholic & lithocholic).

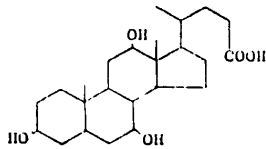
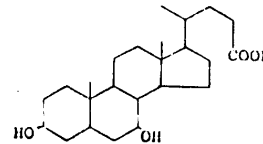
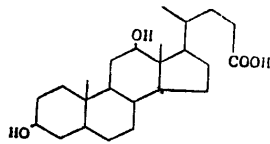
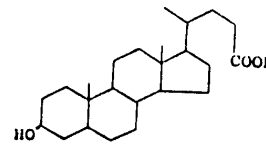
**Cholic acid****Chenodeoxycholic acid****Deoxycholic acid****Lithocholic acid**

- 5) Conjugated in liver with glycine (glycocholic acid) or taurine (taurocholic acid) and excreted in bile as sodium & potassium salts (bile salts).
- 6) Function:
 - a) They are amphipathic (polar -OH groups and nonpolar -CH₃ groups) and act as emulsifying agent (Refer to phospholipids) in the intestine helping to prepare TG and other lipids for degradation by pancreatic lipase.
 - b) Bile salts are important route for cholesterol excretion from the body through bile.

Steroid hormones:**1) Adrenocortical hormones (corticoid H):**

- They are C_{21} hormones derived from cholesterol in the adrenal cortex.

- **Two types:**

a) Glucocorticoids:

- It has = O group at C_3 , double bond between C_4-C_5 and a ketol group (-CO.CH₂.OH) at C_{20} .

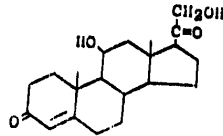

Corticosterone

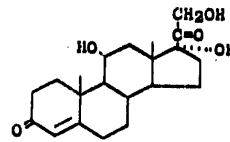

Cortisol

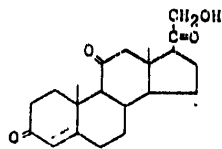

11- Dehydrocorticosterone

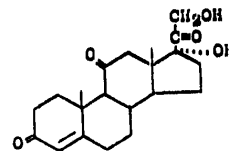
Cortisone
(11- Dehydrocortisol)

- **Include:**

- i) Cortisol (Hydrocortisone): the most potent glucocorticoid hormone.
- ii) Corticosterone: Secreted in lesser amount.
- iii) Cortisone & 11-dehydrocorticosterone. Act only after conversion to cortisol & corticosterone by tissues.

- **Function:** Regulate carbohydrate, protein & lipid metabolism.

b) Mineralocorticoids:

- **Include:**

- i) Aldosterone: The most potent, similar in structure to corticosterone but C_{13} has CHO instead of $-CH_3$.

- ii) 11-deoxycorticosterone (DOC): Less active, similar to corticosterone without -OH at C₁₁.

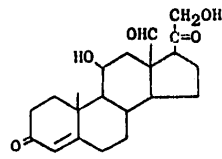

Aldosterone

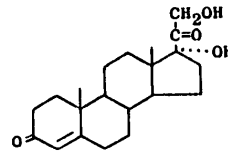

11- Deoxycorticosterone

- Function: Increase renal reabsorption of Na⁺, HCO₃⁻ and Cl⁻ and excretion of K⁺. A synthetic product, DOCA (deoxycorticosterone) is used to treat adrenocortical insufficiency (Addison's disease).

2) Male sex hormones (Androgens):

- They are C₁₉ hormones derived from cholesterol in the testes (interstitial cells of Leydig) and to a lesser extent in the adrenals.
- It has = O or -OH at C₃ & C₁₇.
- Synthesis and metabolism:

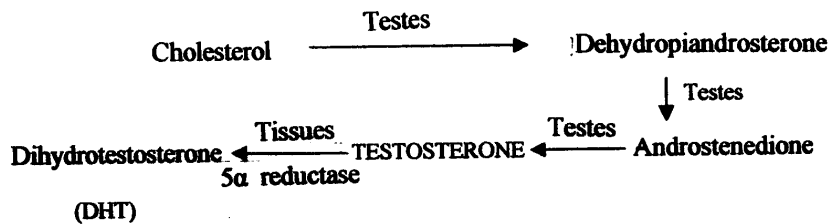

- Include:

- 1) Testosterone: the main hormone (it has a double bond at C₄-C₅).
- 2) Dehydroepiandrosterone & androstenedione: The precursors of testosterone but are less active.
- 3) Dihydrotestosterone (DHT): Derived from testosterone at target cells (upon which the hormone act) and is more active than testosterone.

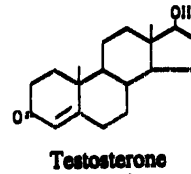
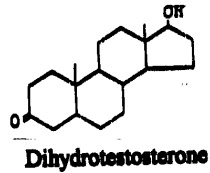
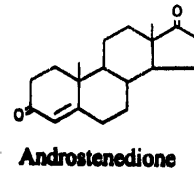
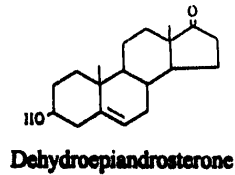

- **Function:** 1) Stimulate development of accessory sex organs (penis, prostate ... etc) and secondary sexual characters (voice, pubic hair ... etc). 2) Stimulate spermatogenesis. 3) Anabolic effect on proteins.

3) Female sex hormones:

- **Two types:**

a) Estrogens:

- They are C_{18} hormones derived from cholesterol in the ovaries (Granulosa cells) and placenta and to a lesser extent in the testes & adrenals.
- It has no $-CH_3$ at C_{10} , it has $-OH$ or $=O$ at C_{17} .
- **Synthesis and metabolism:**

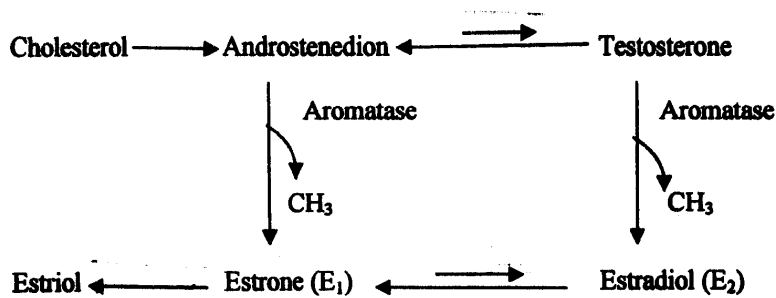

- Liver, adipose cells and skin have aromatase enzyme activity. Therefore these

tissues synthesize estrogens from androgens (in males & females).

- Include:

- 1) Estradiol (E₂): Most active.
- 2) Estrone (E₁): Less active (produced in the liver from E₂).
- 3) Estriol (E₃): Least active (produced in the liver from E₁ & E₂).

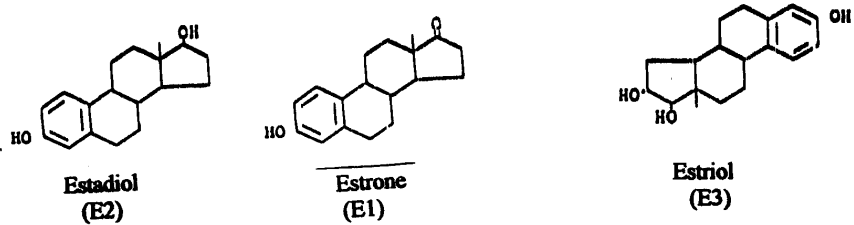

- Function: 1) Stimulate the development of tissues involved in reproduction (vagina, uterus, breast ...etc) and secondary sexual characters (feminine body fat, pubic hair, voice...etc). 2) Responsible for the proliferative phase of menstrual cycle. 3) Anabolic effect on proteins.

b) Progesterone:

- It is C₂₁ hormone derived from cholesterol in the ovaries, placenta & adrenal cortex.

- 1) Ovaries: by corpus luteum cells in second half of menstrual cycle & during the first 6-8 weeks of pregnancy.
 - 2) Placenta: during mid- and late periods of pregnancy.
- It has =O at C₃, double bond between C₄-C₅ and a ketol group (-CO.CH₃) at C₂₀.



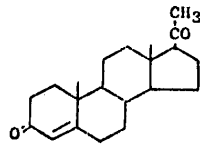

Progesterone

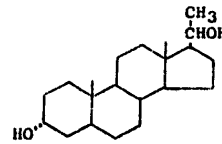

Pregnanediol

- **Function:** 1) Prepare the uterus for pregnancy by changing uterine epithelium from proliferative to secretory phase . 2) Stimulate acini & alveoli of breast during puberty & pregnancy. It inhibits milk production and secretion in late pregnancy.

17- Ketosteroids:

- These are excretory metabolites of androgens synthesized in the testes & adrenals & excreted in urine.
- They are compounds with = 0 at C₁₇, they are neutral (excluding the acidic estrone).
- Include: Dehydroepiandrosterone (DHEA), androsterone, epiandrosterone & etiocholanolol. They are inactive or less active than the parent compound.
- Normal values: 5 - 15 mg/day in females and 10 - 20 mg/day in males in urine.
- Increased level in increased adrenocortical function (**Cushing's syndrome**) and testicular tumors.
- Decreased level in decreased adrenocortical function (**Addision's disease**) & male hypogonadism.

CAROTENOIDS

Definition:

Derived lipids; yellow to red pigments associated with fat in nature.

Examples:

A) Carotenes: They are hydrocarbons (C & H only):

1) Lycopene: red pigments in tomatoes & water melon.

2) α , β , γ carotenes: yellow pigments in human fat, milk, butter & yellow vegetables & fruits as carrots, apricots..... etc.

- Carotenes consist of 2 ionone rings (one β -ionone on one side and either α - or γ -ionone on the other side) and 2 isoprene units attached to every ionone ring & joined by $-\text{CH}=\text{CH}-$.

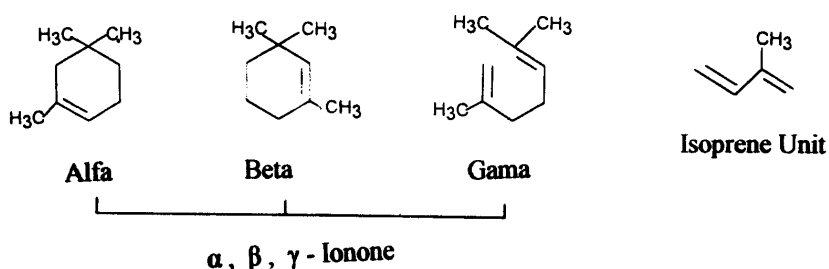

B) Carotenols (oxygenated carotenes or xanthophylls):

- They are oxygenated hydrocarbons (C, H & O).

- Present in egg yolk (**cryptoxanthene**), corn (**zeaxanthene**) and oranges (**lutein**).

Importance:

- Provitamin A (all carotenoids containing β -ionone ring like α , β & γ carotenes & cryptoxanthene).

- They are transformed in the intestine to vit A (Retinol).

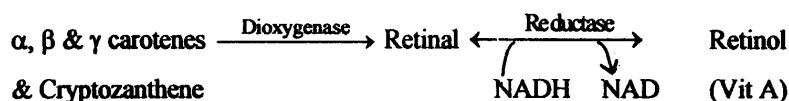

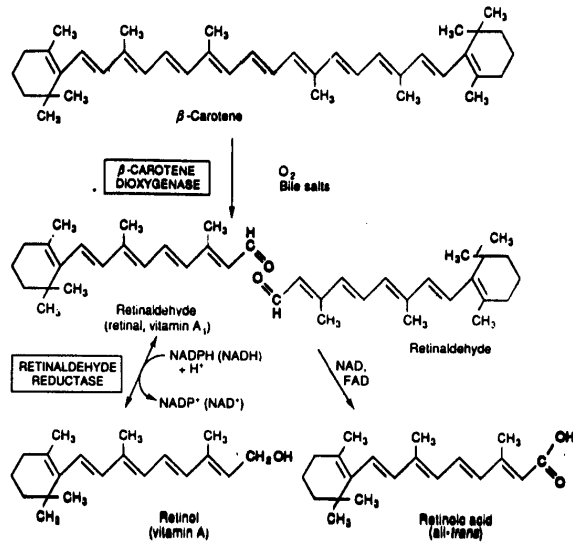

Beta carotene cleavage and transformation into Vit A (retinol) and retinoic acid.

AMINO ACIDS

Definition:

Organic acids containing both amino and carboxyl groups attached to the same carbon atom (α -amino acids).

Importance:

- About 20 amino acids form proteins which have structural, hormonal and enzymatic functions.
- Amino acids and their derivatives participate in intracellular functions as nerve transmission, regulation of cell growth and biosynthesis of purines and pyrimidines (nucleic acids synthesis) and urea.
- D & L amino acids are present in polypeptide antibiotics formed by microorganisms.

General Properties:

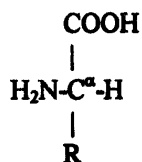

- 1) All are L- α -amino acids in proteins.
- 2) α -carbon atom is asymmetric (except for glycine) and amino acids are either dextro- or levorotatory to plain polarized light.
- 3) Have 2 ionizable weak acid group ($-\text{COOH}$ & NH_3^+) and in solution each group exists in 2 forms (charged and uncharged) in protonic equilibrium:

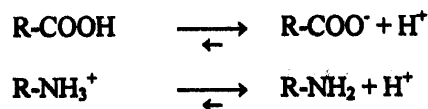

- Ionizable forms of amino acids:

a) Protonated groups (Acidic): $-\text{COOH}$ & NH_3^+ (proton donors).

b) Deprotonated groups (Base): $-\text{COO}^-$ & NH_2 (proton acceptors).

- R-COOH is a far stronger acid than R-NH_3^+ .

- In highly acidic solutions (pH 2) both carboxyl & amino groups are protonated (H^+ is added) and the amino acid will be positively charged (a cation):

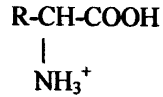

- In highly basic solutions (pH 11) the carboxyl group is deprotonated and the amino acid becomes negatively charged (an anion):

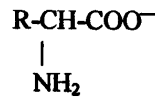

- At physiological pH 7.4-7.1 (that of blood & cells) carboxyl group is deprotonated and amino group is protonated. Thus amino acids carry both negative & positive charges.

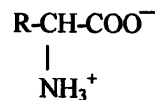

- The net charge is the algebraic sum of all the positively and negatively charged groups present in an amino acid and depends on the pH (proton concentration) of the surrounding medium.

- At isoelectric pH (pI) amino acids carry no net charge and present as "Zwitterions" and carry both negative & positive charges.

- pI is the mean of pK values (acid dissociation constants) of R-COOH (pK_1), R-NH_3^+ (pK_2) and any other ionizable group in an amino acid.

$$\text{pI} = \frac{\text{pK}_1 + \text{pK}_2 + \text{----- etc}}{\text{number of ionizable groups}}$$

- pI of neutral amino acids (one NH_2 & one COOH), is around 6 because the acidity of $-\text{COOH}$ is much stronger than the basic nature of $-\text{NH}_2$.

- pI of acidic amino acids is less than 6 and that of basic amino acids is greater than 6.

Classification of amino acids:

A) According to side chain:

- Aliphatic side chain:

- 1) Glycine: α -amino acetic acid
- 2) Alanine: α -amino propionic acid
- 3) Valine: α -amino isovaleric acid
- 4) Leucine: α -amino isocaproic acid
- 5) Isoleucine: α -amino β -methyl β -ethyl propionic acid

- Side chain containing hydroxyl (OH group):

- 1) Serine: α -amino β -hydroxy propionic acid.
- 2) Threonine: α -amino β -hydroxy butyric acid.
- 3) Tyrosine: α -amino β -hydroxyphenyl propionic acid.

- Side chain containing sulfur atoms:

- 1) Cysteine: α -amino β -thiol propionic acid.
- 2) Methionine: α -amino β -methyl thiobutyric acid.

- Side chain containing acidic groups:

- 1) Aspartic acid: α -amino succinic acid.
- 2) Asparagine:
- 3) Glutamic: α -amino glutaric.
- 4) Glutamine:

- Side chain containing basic groups:

- 1) Arginine: α -amino delta guanido valeric acid.
- 2) Lysine: α -theta diamino caproic acid.
- 3) Histidine: α -amino β -imidazol propionic acid.

- Side chain containing aromatic rings:

L - α - Amino acids present in proteins

Name	Symbol	Structural Formula
With Aliphatic Side Chains		
Glycine	Gly (G)	$\begin{array}{c} \text{H}-\text{CH}-\text{COO}^- \\ \\ \text{+NH}_3 \end{array}$
Alanine	Ala (A)	$\begin{array}{c} \text{CH}_3-\text{CH}-\text{COO}^- \\ \\ \text{+NH}_3 \end{array}$
Valine	Val (V)	$\begin{array}{c} \text{H}_3\text{C} \\ \\ \text{CH}-\text{CH}-\text{COO}^- \\ \\ \text{H}_3\text{C} \quad \text{+NH}_3 \end{array}$
Leucine	Leu (L)	$\begin{array}{c} \text{H}_3\text{C} \\ \\ \text{CH}-\text{CH}_2-\text{CH}-\text{COO}^- \\ \\ \text{H}_3\text{C} \quad \text{+NH}_3 \end{array}$
Isoleucine	Ile (I)	$\begin{array}{c} \text{CH}_3 \\ \\ \text{CH}_2 \\ \\ \text{CH}-\text{CH}-\text{COO}^- \\ \\ \text{CH}_3 \quad \text{+NH}_3 \end{array}$
With Side Chains Containing Hydroxylic (OH) Groups		
Serine	Ser (S)	$\begin{array}{c} \text{CH}_2-\text{CH}-\text{COO}^- \\ \\ \text{OH} \quad \text{+NH}_3 \end{array}$
Threonine	Thr (T)	$\begin{array}{c} \text{CH}_3-\text{CH}-\text{CH}-\text{COO}^- \\ \quad \\ \text{OH} \quad \text{+NH}_3 \end{array}$
Tyrosine	Tyr (Y)	See below.
With Side Chains Containing Sulfur Atoms		
Cysteine†	Cys (C)	$\begin{array}{c} \text{CH}_2-\text{CH}-\text{COO}^- \\ \\ \text{SH} \quad \text{+NH}_3 \end{array}$
Methionine	Met (M)	$\begin{array}{c} \text{CH}_2-\text{CH}_2-\text{CH}-\text{COO}^- \\ \\ \text{S}-\text{CH}_3 \quad \text{+NH}_3 \end{array}$
With Side Chains Containing Acidic Groups or Their Amides		
Aspartic acid	Asp (D)	$\begin{array}{c} \text{-OOC}-\text{CH}_2-\text{CH}-\text{COO}^- \\ \\ \text{+NH}_3 \end{array}$
Asparagine	Asn (N)	$\begin{array}{c} \text{H}_2\text{N}-\text{C}-\text{CH}_2-\text{CH}-\text{COO}^- \\ \quad \\ \text{O} \quad \text{+NH}_3 \end{array}$

L - α - Amino acids present in proteins

Name	Symbol	Structural Formula
Glutamic acid	Glu [E]	$^{-}\text{OOC}-\text{CH}_2-\text{CH}_2-\underset{\substack{ \\ \text{+NH}_3}}{\text{CH}}-\text{COO}^{-}$
Glutamine	Gln [Q]	$\text{H}_2\text{N}-\underset{\substack{ \\ \text{O}}}{\text{C}}-\text{CH}_2-\text{CH}_2-\underset{\substack{ \\ \text{+NH}_3}}{\text{CH}}-\text{COO}^{-}$
With Side Chains Containing Basic Groups		
Arginine	Arg [R]	$\text{H}-\underset{\substack{ \\ \text{C}=\text{NH}_2 \\ \\ \text{NH}_2^+}}{\text{N}}-\text{CH}_2-\text{CH}_2-\text{CH}_2-\underset{\substack{ \\ \text{+NH}_3}}{\text{CH}}-\text{COO}^{-}$
Lysine	Lys [K]	$\underset{\substack{ \\ \text{+NH}_3}}{\text{CH}_2}-\text{CH}_2-\text{CH}_2-\text{CH}_2-\underset{\substack{ \\ \text{+NH}_3}}{\text{CH}}-\text{COO}^{-}$
Histidine	His [H]	$\text{HN} \begin{array}{c} \diagup \\ \text{+} \\ \diagdown \end{array} \text{NH} \text{---} \text{CH}_2-\underset{\substack{ \\ \text{+NH}_3}}{\text{CH}}-\text{COO}^{-}$
Containing Aromatic Rings		
Histidine	His [H]	See above.
Phenylalanine	Phe [F]	$\text{C}_6\text{H}_5-\text{CH}_2-\underset{\substack{ \\ \text{+NH}_3}}{\text{CH}}-\text{COO}^{-}$
Tyrosine	Tyr [Y]	$\text{HO}-\text{C}_6\text{H}_4-\text{CH}_2-\underset{\substack{ \\ \text{+NH}_3}}{\text{CH}}-\text{COO}^{-}$
Tryptophan	Trp [W]	$\text{C}_8\text{H}_6\text{N} \begin{array}{c} \diagup \\ \text{H} \\ \diagdown \end{array} \text{---} \text{CH}_2-\underset{\substack{ \\ \text{+NH}_3}}{\text{CH}}-\text{COO}^{-}$
Imino Acids		
Proline	Pro [P]	$\text{C}_5\text{H}_7\text{N}^+ \begin{array}{c} \diagup \\ \text{H}_2 \\ \diagdown \end{array} \text{---} \text{COO}^{-}$

- 1) Histidine: α -amino β -imidazol propionic acid.
- 2) Phenylalanine: α -amino β -phenyl propionic acid.
- 3) Tyrosine: α -amino β -hydroxyphenyl propionic acid.
- 4) Tryptophan: α -amino β -indole propionic acid.

- Imino acids:

- 1) Proline: Pyrrolidine 2-carboxylic acid.

B) According to relative polarities of side chain (R-COOH):

Polar (Hydrophilic)		Nonpolar (Hydrophobic)
Arginine	Serine	Alanine
Asparagine	Threonine	Isoleucine
Aspartic		Leucine
Cysteine		Methionine
Glutamic		Phenylalanine
Glutamine		Proline
Glycine		Tryptophan
Histidine		Tyrosine
Lysine		Valine

1) Polar side chain (Hydrophilic):

- These amino acids make protein soluble in water (hydrophilic) and insoluble in lipids (hydrophobic).

2) Nonpolar aliphatic or aromatic side chain (Hydrophobic):

- Water is removed when two nonpolar side chains (-CH₃ ... CH₃- or -Benzene ... CH₃-) of a protein come together (hydrophobic interaction forces). These forces are important for folding of protein in secondary and tertiary structure.

C) According to reaction:

- 1) Acidic: contain two -COOH.

- Aspartic & glutamic.
- 2) **Basic:** contain one -COOH and two or more basic groups.
 - Lysine, Arginine, Histidine.
- 3) **Neutral:** contain equal number of -COOH and basic groups.
 - Glycine, serine, alanine, valine, leucine, isoleucine, serine, threonine, cysteine, methionine, phenylalanine.

D) Nutritional classification:

- 1) **Nonessential amino acids:** can be synthesized in the body from endogenous metabolites and may not be supplied with food.
- 2) **Essential amino acids:** cannot be synthesized in the body and must be supplied in food. They include **10 amino acids** = Arginine, histidine, methionine, isoleucine, leucine, lysine, phenylalanine, threonine, tryptophan & valine.
- 3) **Semiessential amino acids:** can be synthesized from another essential amino acid like tyrosine from phenylalanine & cysteine from methionine.

Special notes on classification of amino acids:

- 1) Cystine is an amino acid formed of two molecules of cysteine united through disulfide bond (-S-S-) to join two polypeptides.
- 2) Hydroxyproline & hydroxylysine are amino acids present in excess in collagen protein by hydroxylation of proline & lysine at the end of protein biosynthesis.
- 3) Ornithine, citruline and argininosuccinic acid are amino acids produced during the cycle of urea synthesis but do not enter in body structure.

Physical properties of amino acids:

- 1) Soluble in water & ethanol (polar solvents) because amino acids have multiple charged groups. They are insoluble in nonpolar solvents (benzene, ether & hexane).
- 2) High melting point (>200°C) due to the high ionic forces that stabilize the crystalline form of amino acids.

3) **Optical activity:** All amino acids (except glycine) are optically active (dextro- or levorotatory forms) due to the presence of asymmetric carbon.

Absorption spectrum of amino acids:

All amino acids do not absorb visible light (they are colorless) & most of them do not absorb UV light also. However, amino acids with aromatic side chains (tryptophan, phenylalanine, tyrosine & histidine) absorb UV light at wave length = 240-300 nm. Proteins can be assayed by measurement of their maximal absorption at 280 nm due to their tryptophan content.

Chemical properties of amino acids:

A) Reactions due to amino group:

- All aliphatic amino acids will give the following reactions:

1) **Transamination:** Transfer of amino group from an amino acid to α -keto acid to form another amino acid and a new α -keto acid.

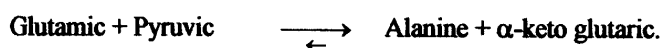

2) **Methylation:** Transfer of methyl group to the amino group of amino acids producing methyl derivative (glycine \rightarrow sarcosine).

3) **Reaction with CO_2 :** Form carbamino acids which transport CO_2 from tissues to lungs.

B) Reactions due to carboxyl group:

1) **Decarboxylation reactions** (removal of CO_2) will transform amino acids into biologically active compounds (amines).

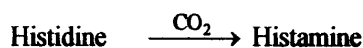

(Histamine is a mediator of allergy).

C) Reaction due to -R group:

1) **Xanthoprotein test:**

Proteins containing amino acids with benzene ring (ph.ala, tyr) when heated with concentrated nitric acid give yellow precipitate.

2) Millon's test:

Proteins containing tyrosine when heated with Millon's reagent (nitric acid solution of mercuric and mercurous nitrites and nitrates) give brick red precipitate.

3) Sulfur test:

Proteins containing cysteine and cystine (but not methionine) when boiled with NaOH then lead acetate is added give a brown to black precipitate.

4) Rosenheim test:

Proteins with tryptophan (indol ring) give violet ring when formaldehyde is added in presence of ferric chloride (as an oxidant) and H_2SO_4 .

D) Reactions due to both amino & carboxyl groups:**1) Ninhydrin reaction:**

Amino acids react with ninhydrin to give CO_2 , NH_3 and an aldehyde. Ammonia will complex with ninhydrin & produce a blue or purple color. This reaction is positive with proteins & peptides containing at least one free -COOH & one free $-NH_2$. Proline & hydroxyprolines (imino acid) give yellow color. The test is sensitive up to μg quantities.

2) Fluorescamine reaction:

Fluorescamine forms a complex with amino acids and produces blue color. The test is more sensitive than ninhydrin reaction (detect up to ng).

3) Amphoteric property:

- Amino acids can react with both acids and bases (amphoteric electrolytes or ampholytes).
- They carry positive charge in acid medium (cation) and negative charge in alkaline medium (anion).
- Between acidity and alkalinity amino acids carry equal amount of positive and negative charges & there is no net charge. The amino acid becomes a "Zwitterion".

- pI (isoelectric point) is the pH at which an amino acid carries no net charge. At pI amino acids do not move in an electric field.

4) Peptide bond formation:

- Formed between α -COOH group of one amino acid and an α -amino group of another amino acid with removal of one mole of H_2O .
- A dipeptide has one peptide bond and tripeptide has 3 bonds.

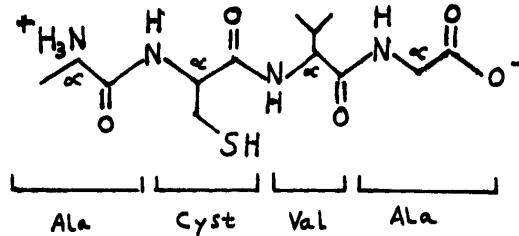

PEPTIDES

Definition:

2 - 50 L- α -amino acids linked by peptide bonds.

Structure:

- 1) Has N-terminal (free α -amino group) on the left and a free C-terminal (free α -carboxyl group) on the right.
- 2) Peptides are elongated from their C-terminals during protein bisynthesis.
- 3) Primary structure of a peptide is formed from certain arrangement (sequence) of amino acids specific for every peptide.
- 4) Substitution of a single amino acid for another amino acid will abolish the biological activity of the peptide. This occurs in **inborn errors of metabolism due to mutations in the gene for that peptide.**

At physiological pH, **peptide bonds** are uncharged due to net loss of one positive (NH_3^+) and one negative ($-COO^-$) charge as a result of its formation. However, **peptides are charged** due to their C- & N-terminals and acidic or basic - R groups.

5) No freedom of rotation about the peptide bond (**partial double bond character**) and all 4 atoms around peptide bonds (-N-C-) lie in the same plane (**coplanar**) without free rotation inducing **rigidity in 2/3 of peptide chain**. However, there is free rotation on either side of peptide bonds (bonds connecting α -carbon with α -nitrogen). The rigid and planar characters of peptide bonds is important for secondary and tertiary structures of proteins.

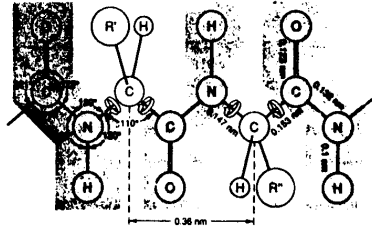

Polypeptide chain. Polypeptide bond is shaded (4 atoms are coplanar). Free rotation can occur about the bonds connecting the α -nitrogen and α -carbonyl (white arrows).

Biologically active peptides:

1) Glutathione (GSH):

- Tripeptide formed of glutamic acid + cysteine + glycine.
- It is **atypical peptide** because the γ -carboxyl group of glutamic is attached to α -amino group of cysteine.
- -SH group of cysteine is the active part of it.

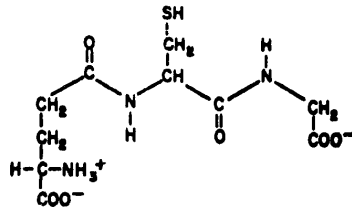

Glutathione (γ -glutamyl - cystinyl glycine)

- **Function:**

a) Removal of the toxic hydrogen peroxide from cells

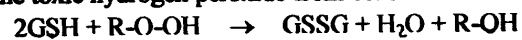

- b) Protect cell membranes & proteins from oxidants.
- c) Important for amino acid transport.
- 2) Hormones:**
 - a) Thyrotropin releasing hormone (TRH): peptide of 3 amino acids (a.a).
 - b) Angiotensin (8 a.a).
 - c) Vasopressine (9 a.a).
 - d) Gastrin (17 a.a).
 - e) Glucagon (17 a.a).
 - f) β -lipotropin (91 a.a) (β -LPH): It is a pituitary hormone and is the precursor of other peptides like endorphins & enkephalins by hydrolysis of large β -LPH in tissues. It causes lipolysis and fatty acid mobilization.
 - g) β -endorphins (31 a.a): It is a pituitary hormone derived from β -LPH. It acts as neurotransmitters and may play a role in control of pain (like morphine).
- 3) Bradykinin: 9 amino acids peptide present in plasma and has smooth muscle relaxant action leading to hypotension.

PROTEINS

Definition:

- 1) Polypeptide chains, more than 50 L α am.ac. residues.
- 2) Am.ac. sequence in polypeptide chain is the primary structure of proteins & is predetermined by the DNA sequence of the gene.

Function:

- A) Structural: Form 1) Collagen and elastin which form the matrix of bone & ligaments. 2) α -keratin in epidermal tissues.
- B) Dynamic: Form 1) Enzymes for metabolic control. 2) Hormones e.g. insulin, growth hormone, LH, FSH, thyrotropin, parathormone. 3) Transport in blood of ions, steroid hormones, O₂ (in hemoglobin & myoglobin), drugs and toxins.

4) Myosin and actin (muscle contraction). 5) Immunoglobulins & fibrin (protection). 6) Biologically active peptides. 7) Proteins that control gene transcription and translation (histones, repressors ... etc). 8) Receptors on cell membranes.

Classification:

A) Simple proteins: Contain only L α am.ac. classified according to solubility into:

1) Proteins soluble in water:

a) Albumin: (ovalbumin, lactalbumin & serum albumin), heat coagulable, precipitated by saturated ammonium SO_4 solution, high nutritional value.

b) Histones: nucleoprotein, **smallest protein known**, basic (rich in basic am.ac), noncoagulable by heat.

c) Protamines: nucleoprotein of fish (salmin), basic (rich in basic am.ac), noncoagulable by heat.

2) Proteins soluble in dilute salt solution:

Globulins: (serum globulin, ovglobulin & lactglobulin), high molec. wt, heat coagulable, insoluble in H_2O , precipitated by $\frac{1}{2}$ saturated solution of ammonium SO_4 solution.

3) Proteins soluble in 70 - 80% alcohol:

Prolamins (Gliadins): cereals (zein of maize & gliadin of wheat), insoluble in H_2O , gives sticky consistency of dough, low biological value (deficient in lysine & rich in proline and glutamic acid).

4) Proteins soluble in dilute acid and alkalies:

Glutelins: cereals (wheat), coagulated by heat, high biological value.

5) Insoluble proteins: Scleroproteins (albuminoids): fibrous, present in supportive tissues. They include : collagen, elastin, keratin and reticulin.

B) Conjugated proteins: contain nonprotein substance (prosthetic group).

Include:

- 1) **Phosphoproteins:** phosphates as prosthetic group attached to OH group of lysine & threonine of the protein. They include:
 - a) Caseinogen (rich in methionine)
 - b) Vitelline of egg yolk.
 - c) Phosphorylated enzymes (of glycogen metabolism).
- 2) **Glycoproteins & glycosaminoglycans (GAG):**
 - a) Glycoproteins: about 5% carbohydrate, in TSH, FSH, LH and plasma proteins, no hyaluronic acid.
 - b) GAG: More than 95% carbohydrate, in mucins (saliva, synovial membrane... etc), contain hyaluronic acid.
(Please refer to carbohydrates for details).
- 3) **Chromoproteins:** chromophoric group (metal or nonmetal) as prosthetic group.
Classified into:
 - a) **Metallochromoproteins or hemoproteins:** contain heme (iron porphyrin ring) as prosthetic group. Examples:
 - Hemoglobin: in RBCs, carry O₂ & CO₂.
 - Myoglobin : in muscles, carry O₂.
 - Cytochrome and cytochrome oxidase: in mitochondria, act as electron carrier in oxidation reduction reactions.
 - Catalases & peroxidases: enzymes for removal of hydrogen peroxide in cells.
 - b) **Nonmetallochromoproteins:**
 - Flavoproteins: FMN or FAD as prosthetic gr., yellowish, present in amino acid oxidases.
 - Carotenoid proteins: carotenoid as prosthetic gr, in retinal pigments **rhodopsin** (purple) and **iodopsin** (violet).
 - Melanin pigment as prosthetic gr., brown or black, in hair.
- 4) **Metalloproteins:** metal as prosthetic group. Include:

- a) Iron:
 - Ferritin, the storage form of iron.
 - Transferrin, transport iron in blood.
 - b) Copper:
 - Ceruloplasmine, carry Cu in blood.
 - Hepatocuprin, carry Cu in liver.
 - Enzymes: tyrosinase & cytochrome oxidase contain Cu.
 - c) Zinc:
 - Insulin,
 - Carbonic anhydrase (in RBCs), carboxy-peptidase & alcohol dehydrogenase enzymes.
- 5) Nucleoproteins: nucleic acid as prosthetic group conjugated with histones and protamines (ribo- & deoxyribonucleoproteins) (RNP & DNP).

Structure of proteins:

A) Overall shape of proteins: 2 classes depending on overall dimensions (globular & fibrous proteins):

1) **Globular**: axial ratio (length/width) less than 10 (commonly 3 - 4).

- Peptide chains are folded or coiled.
- Include: albumin, globulin, insulin, enzymes.

2) **Fibrous**: axial ratio (length/width) less than 10.

- Peptide chains are long, may be coiled in spiral or helix and cross linked by S-S and hydrogen bonds.
- Include: Keratin (hair & wool), myosin, collagen & fibrin.

B) Bonds and forces essential for protein structure: Several bonds & forces in proteins contribute to preserve their native structure.

- 1) Peptide bonds: determine the primary structure of proteins, they are strong, formed during translation of expressed genes (protein biosynthesis), ruptured by proteolytic enzymes.
- 2) Disulfide bonds: S-S bond, formed by interaction of 2 cysteine → cystine, connect 2 polypeptide chains, stable, postranslation, ruptured by performic acid oxidation.

3) Hydrogen bonds: $-NH\dots O=C-$, noncovalent interaction between an atom covalently bound to hydrogen (hydrogen donor) and another electronegative atom (hydrogen acceptor), Examples:

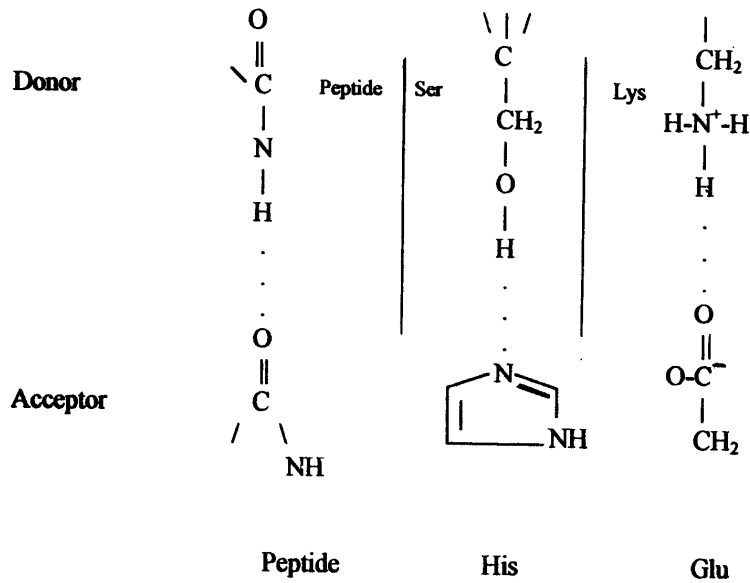

Hydrogen bonds are formed in the secondary and tertiary structure of proteins between amino acid side chains containing loosely bound hydrogen (donors) such as in alcohol groups of serine and threonine and those having electron rich atoms (acceptors) such as: a) nitrogen atoms of histidine or b) carbonyl oxygen of carboxyl, amide groups and peptide bonds. They are weak bonds, postranslationally formed & ruptured by urea and detergents.

4) Hydrophobic interaction forces: when two nonpolar side chains ($-CH_3\dots CH_3-$ & benzene ring $\dots CH_3-$) of a protein dissolved in water come together during folding of proteins \rightarrow water is removed. This induces driving forces to associate two nonpolar side chains. Examples: a) leucine & isoleucine
 b) phenylalanine & valine interaction. One third of H_2O is lost when secondary structure and 2/3 of H_2O when tertiary structure of protein are formed bringing polypeptide chains near each other with the release of water

of solvation between polypeptide chains. These forces occur mostly in the interior of protein molecules.

- 5) **Ionic or electrostatic interactions:** occur between two oppositely charged groups in the side chains (- & +ve). Example: NH_3^+ (lysine & arginine) and COO^- (aspartic & glutamic). However, these charged groups occur on the surface of proteins to interact with water.
- 6) **Van der Waals forces:** weakest, present in excess in secondary and tertiary structure of proteins. These forces appear when the electron orbitals of two adjacent atoms approach to a close distance.

Order of protein structure:

- 1) **Primary structure:** It is the arrangement of amino acids in polypeptide chain. It is completely dependent on covalent bonds (peptide bonds). It has an amino terminal (N) on the left and carboxyl terminal (C) on the right side. It is an extended structure which includes the location of disulfide bonds between 2 cysteine am. ac.
- 2) **Secondary structure:** It is the folding of the polypeptide chain. It is present in either α -helix or β -structure.
 - a) **α -helix:**
 - Is a coiled (spiral) structure, either left or right handed.
 - Each turn of the coil is formed of 3 - 6 am . ac residues.
 - Side chains are on the outside of the spiral.
 - The spiral is held together by 2 hydrogen bonds in every turn.
 - Examples: coiled structure of fibrous proteins (fibrinogen, myosin & keratin).
 - b) **β -structure:**
 - Is an extended structure of several polypeptide chains.
 - One chain is hydrogen bonded to another.
 - The two strands are aligned either in a parallel or antiparallel direction.
 - Hydrogen bonded strands appear like a **pleated sheet**.

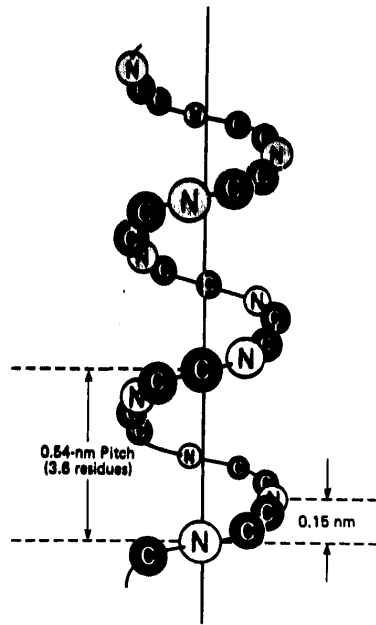

α - helix . Notice the dimensions and axis of the helix,

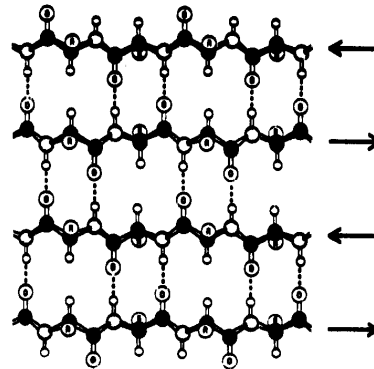

β - pleated sheet . Adjacent polypeptide chains run in opposite direction (antiparallel).

- Side chain appears above & below the sheet.
 - Example: β form of keratin in extended hair & silk fibroin.
- 3) **Tertiary structure**: It is the further twisting and folding of secondary and supersecondary structure of large proteins.
- Gives proteins globular shape (three dimensional) consisting of variable amounts of coils with no regular structure . In addition α -helix & β -pleated sheet structures are found.
 - Stabilized by hydrogen bonds, hydrophobic interactions, ionic interactions and disulfide bonds.

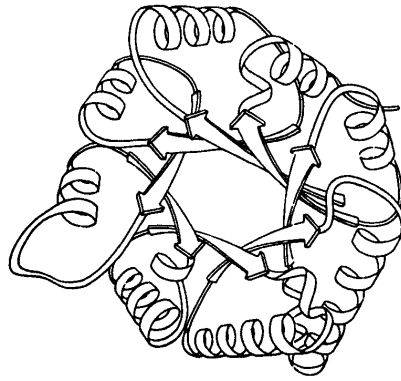

Tertiary structure of proteins.

- Disulfide bonds make proteins resistant to denaturation.
 - Hydrophobic am. ac (nonpolar) tend to be in the interior of protein which is important for stability of folded structure.
 - Hydrophilic am. ac (polar) with charged side chains are formed on the surface of proteins forming hydrogen bonds with H_2O .
 - Large protein often folds into compact units (**Domains**) connected by a segment of the polypeptide chain. Catalytic sites of enzymes are found in the region between two domains. In multifunctional proteins, each domain performs a different function.
- 4) **Quaternary structure:** It is the arrangement of polypeptide chains in multichain protein → **oligomers**.

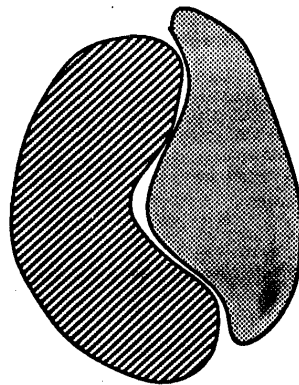

Quaternary structure of proteins.(dimers of dissimilar subunits).

- Individual polypeptide chain is termed **subunit**.
- Subunits are aggregated by noncovalent bonds.
- Oligomeric protein contains 2 - 4 subunits (**dimers or tetramers**).
- Hemoglobin has quaternary structure. However myoglobin is monomeric protein.

Conformation of proteins:

- It is the spontaneous folding of polypeptide chain to its **native secondary and tertiary conformation** which is specific and active.
- It occurs under the correct solvent conditions and in presence of prosthetic groups that may be part of its structure.
- Quaternary structures also assemble spontaneously.
- Denaturation of proteins occurs when they **lose their native secondary, tertiary and quaternary structure**. The primary structure is not necessarily broken.

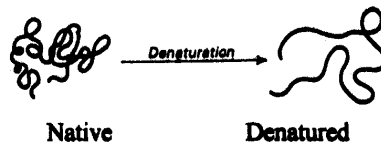

Properties of proteins:

1) Solubility:

- In water: most protein (albumins, histones, protamines).
- In 70-80% alcohol: prolamines.
- In dilute acid and alkalies: Glutelins.
- In dilute salt solution: Globulins.
- Insoluble proteins: scleroproteins.

2) Amphoteric character:

- Proteins have NH_2 and COOH groups which make them react with acids and alkalies (amphoteric).
- Each protein has its own isoelectric point (pI) at which it carries both positive

& negative charges and does not move in an electrical field.

- At pH greater than pI a protein has a net negative charge (**anionic**).
- At pH less than pI a protein has a net positive charge (**cationic**).

3) Precipitation by:

a) Concentrated salt solution (salting out):

- Occurs in 2 steps: First, the protein is dehydrated. Second, charges on protein surface are neutralized by salt ions → precipitation.
- Example: Globulins are precipitated by ½ saturation of ammonium sulfate or full saturation of NaCl.

b) Salts of heavy metals (Hg, Ag & Pb):

- Occurs on alkaline side of pI of protein.
- Formation of insoluble metal proteinate.

c) Alcohol: Occurs in 2 steps: First, alcohol dehydrate proteins. Second, charges on protein surface are neutralized by salt ions → precipitation.

d) Alkaloidal reagents: (trichloroacetic, picric & tannic acids).

- Occurs on acid side of pI (the positively charged proteins combine with the negatively charged anionic part of the alkaloid → protein picrate or tannate (insoluble)).

4) Denaturation:

It is the destruction of secondary, tertiary & quaternary structures of proteins without hydrolysis of peptide bonds with **loss of native structure**.

It is due to **cleavage of noncovalent bonds in proteins**.

- Produced by:

- a) Physical agents: heat, UV light, high pressure.
- b) Chemical agents: acids, alkalis, urea, guanidine...etc.

- Result in:

- a) Loss of biological activity.
- b) Decrease of solubility.

- c) Exposure of many hidden groups.
 - d) -S-S- bonds are changed to -SH group of cysteine.
 - e) Loss of crystallization.
 - f) Increased digestibility.
- It might be **reversible or irreversible**:
- a) Urea & guanidine → reversible (after dialysis).
 - b) Acids, alkalis, salt of heavy metals, alkaloids → irreversible.

5) Flocculation:

It is clumping of denatured protein by heat.

- Occurs in steps: First, the protein is heated far away from its pI → denaturation. Second, adjust pH to pI of protein, then heat → clumping of denatured protein.
- **Reversible**: if pH is adjusted away from pI of protein.

6) Heat coagulation:

- Further heating of flocculated protein leads to irreversible union between peptide chains forming a mass (**coagulum**) which is insoluble at the entire pH range.

Methods of isolation and purification of proteins:

A) Precipitation:

- 1) Albumin: by full saturation of ammonium sulfate.
- 2) Globulin: by ½ saturation of ammonium sulfate.

B) Ultracentrifugation:

Mixture of proteins are separated by ultracentrifugation (very high speed) depending on their molecular weight.

C) Electrophoresis:

When a protein is dissolved in a solution containing a buffer at a certain pH, and is placed in an electric field, it will migrate toward the anode or cathode depending on the number of charges, size and shape of its molecule. On acid

side of pI, proteins carry positive charge and migrate to the cathode. On alkaline side it carry negative charge and migrate to the anode. Plasma proteins can be separated by electrophoresis.

D) Chromatography:

- 1) Gel filtration: small insoluble beads (Gel) are used to separate proteins according to their size using columns. Large proteins pass lower down the column first followed by low molecular weight proteins.
- 2) Affinity chromatography: proteins have high affinity for their substrates, membrane receptors, prosthetic group and antibodies. When these high-affinity compounds are covalently attached to an **insoluble resin (bead)** they can be used to purify the respective protein using column chromatography. The protein will be bound to the beads while nonrelated proteins pass down the column.

Collagen:

A) It is a fibrous scleroprotein, most abundant protein in the body (25% of proteins in mammals), present in extracellular matrix (ECM).

B) Type of collagen: vary according to structural role it plays in a certain organ:

- 1) Gel form to stiffen the structure: in extracellular matrix and vitreous humor of the eye.
- 2) Bundled in tight parallel fibers to provide great strength: in tendons.
- 3) Stacked so as to transmit light with minimal scattering: in cornea.
- 4) Fibers arranged at angles to each other so as to resist mechanical shear from any direction: Bone.
- 5) Mesh like network: kidney glomeruli, basement membrane, lens capsule.

C) Structure:

- 1) Has **three polypeptide chains** called α -chains ($\alpha_1, \alpha_2, \alpha_3$) twisted around each other like a rope (**triple helix**).

2) Primary structure:

- Each α -chain is formed of 1000 amino acid residues present as repeating sequence of **glycine-proline-hydroxyproline or hydroxylysine**: / Gly-Pro- Hyp /Gly -Pro -Hyl/Gly-Pro - Hyp / (glycine is present at every third position of the triple helical portion of the alpha chain).

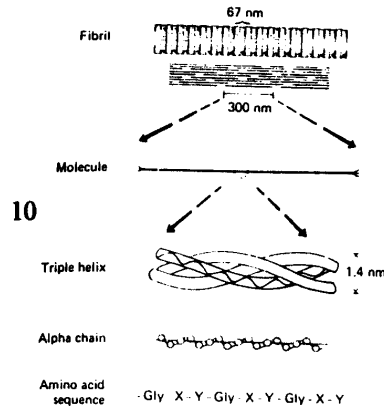

Collagen structure from primary structure up to the fibril.

- Hydroxylysine & hydroxyproline are not found in most other tissue proteins. They are formed posttranslationally (after protein synthesis by hydroxylation of lysine and proline residues in the polypeptide chain).
 - Posttranslational **glycosylation** of α -chain occurs by joining galactose or galactosyl-glucose through O-glycosidic bond with OH group of hydroxylysine.
- 3) Triple helical structure:
- Each α -chain is twisted into left handed helix.
 - The three chains then twisted around each other into a right handed **SUPERHELIX (rope like)**.
 - **Superhelix: rodlike** (1.4 nm width & 300 nm long), three α -chains are held together by hydrogen bonds and interchain S-S bonds.
 - These rodlike **fibril** are further assembled in tissues by bringing many fibrils

- near each other longitudinally forming fibers which are stabilized by covalent cross links that are important for the tensile strength of the fiber.

D) Synthesis & secretion from cells (fibroblasts): like other proteins, collagen is synthesized on ribosomes of fibroblasts. Three structural forms occur during synthesis.

- 1) **Preprocollagen:** the primary structure of collagen before hydroxylation & glycosylation of its am. ac. residues. It contains 50-100 am . ac. at N-terminal that act as signal sequence. This signal direct the chain into the vesicles of endoplasmic reticulum. As it enters the ER this signal is enzymatically removed → procollagen.
- 2) **Procollagen:** a) The preprocollagen is modified by hydroxylation of proline and lysine (using Vit C as reducing agent) in addition to glycosylation of hydroxylsine. b) Interchain S-S bonds are formed at C-terminals of the 3 α -chains helping helix formation.
- 3) **Collagen fibers:** a) Procollagen is secreted outside fibroblasts b) Triple helix and collagen fibril are spontaneously formed. c) Assembly of collagen fibrils into fibers spontaneously d) Stabilization by inter & intrachain cross links.

E) Diseases:

- 1) **Marfan syndrome:** a) Inherited defect in synthesis of the predominant type I collagen (fibrillin) b) Patients are tall and have long fingers & toes, hyperextensible joints, dislocation of the lens & weakness & dilatation of the aorta.
- 2) **Osteogenesis imperfecta:** a) Inherited defect in synthesis of procollagen (type I). b) Patients have abnormal fragility of bones.
- 3) **Ehlers-Danlos syndrome:** a) Inherited defect in synthesis of procollagen (type III) b) Patients have hypermobility of joints & skin abnormalities.

Elastin:

- A) It is a connective tissue protein.
- B) Responsible for extensibility & elastic recoil of tissues.
- C) Present in lungs, blood vessels, elastic ligaments, skin....etc.
- D) Synthesized as **single monomer (tropoelastin)**.
- E) Highly insoluble, extremely stable & has a very low turnover.
- F) Has random coil conformation → easily stretch & recoil.
- G) Differences from collagen: 1) One genetic type. 2) Random coil (no triple helix). 3) No Gly-Pro-Hyp repeating sequence. 4) No hydroxylysine. 5) No carbohydrate. 6) Different cross links.

Hemoglobin:

It is a **globular hemoprotein** that contains **heme** as a **prosthetic gr** & located exclusively in RBCs. Formed of **4 heme units** attached to **globin**. Blood contains about 16 gm%. Its molecular weight equal 67000.

A) Heme:

- 1) Complex of protoporphyrin IX (4 pyrrol rings) and ferrous iron (Fe^{2+}).
- 2) Fe^{2+} is in the center of porphyrin ring and can form **6 bonds**: **a)** four bonds

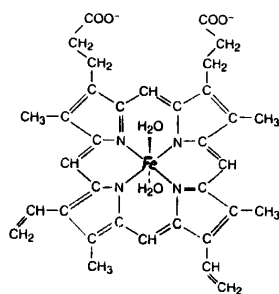

Heme

with the 4 nitrogens of the pyrrol rings. Fe^{2+} & pyrrol rings lie in a common plane. **b)** The fifth and sixth bonds lie perpendicular to the plane of porphyrin

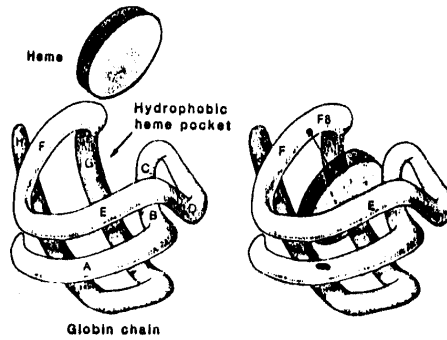

Attachment of heme to a pocket in globin chain.

3) Heme is attached to a pocket in globin chain through noncovalent interactions between nonpolar side chains of am.ac. and nonpolar regions of porphyrin with expulsion of water (hydrophobic interactions).

B) Globin:

1) Hb A₁ (the major hemoglobin in adults):

The globin has four polypeptide chains (2 α & 2 β globin chains) held together by noncovalent bonds forming 2 dimers (α_1, β_1 & α_2, β_2).

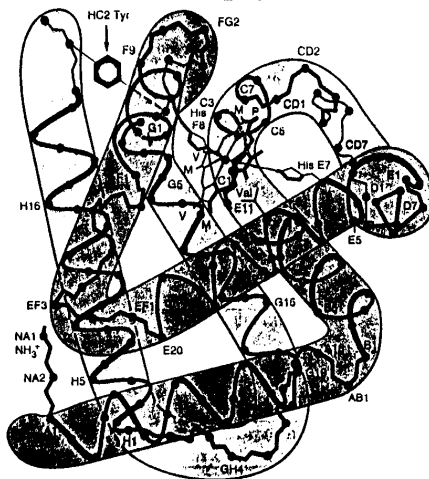

Secondary and tertiary structure of chains of hemoglobin. proximal His F8 and distal His E7 are shown. The α -helical regions are named A through H.

- Am.ac. residues: a) α chain = 141. b) β -chain = 146.
- Secondary structure. α -helix.
- Tertiary structure: a) 75% of the chain is folded into eight stretches of α -helix
- b) The interior of every compact chain is rich in nonpolar am.ac. forming hydrophobic interactions to stabilize the structure. c) The surface of hemoglobin is rich in charged am.ac. which form hydrogen bonds with water.
- d) Every chain has heme binding pocket with 2 histidine am.ac. First is the **proximal histidine** which binds with iron (Fe^{2+}). Second is the **distal histidine** which does not interact with but stabilizes the Fe^{2+} of heme. The distal histidine is free in deoxygenated (reduced) Hb while it is occupied by O_2 in oxygenated Hb state. Therefore oxygenation of Hb is not accompanied by a change of valence of iron (Fe^{2+}). O_2 attracts electrons from the nitrogen of the imidazole ring of distal histidine. This facilitates ionization of the hydrogen

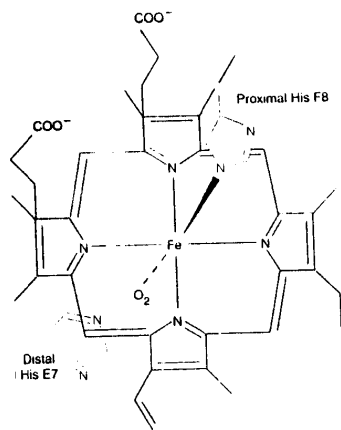

Bonds to ferrous atom in oxyhemoglobin.

atom attached to this nitrogen, making hemoglobin stronger acid than reduced Hb. Change of oxy Hb to reduced Hb attracts hydrogen ions from surrounding medium.

- 2) Hb F (fetal hemoglobin): a) in fetus b) it has 2 α and 2 γ globin chain (γ chain has 146 am.ac like β but with 39 different am.ac. c) slower electrophoretic mobility and lower interaction with 2,3-diphosphoglycerate (2,3, DPG).

C) Hemoglobinopathies:

Diseases due to abnormal Hb leading to hemolytic anaemia. Include:

- 1) Sickle cell anaemia: due to single base pair mutation.
 - Presence of Hb S (instead of Hb A) which contains two normal α -chains and 2 mutant β -chains (replacement of glutamate by valine).
 - The presence of Hb S leads to a) slower electrophoretic mobility than Hb A b) Hb becomes insoluble (rich in nonpolar valine) in absence of oxygen \rightarrow deformed red cells (sickled).
 - Primarily occurs in black population.
 - Hb S protect RBCs from malarial infection
- 2) Thalassaemia: due to reduced synthesis of either α or β -globin chain (α or beta thalassaemia) due to absence or mutation of the gene for α or β -globins.
 - Absence of β -chains leads to aggregation of α -chains and death of cells.
 - Originate in Mediterranean areas and Asia.

D) Hb transport of O₂ & CO₂:

- 1) Hb can bind one O₂ molecule for each of its 4 heme containing subunits (4 globin chains).
- 2) Oxygen saturation curve: the relationship between % saturation of Hb with O₂ and partial pressure of oxygen (PO₂) (mm Hg). It varies from 0-100%.

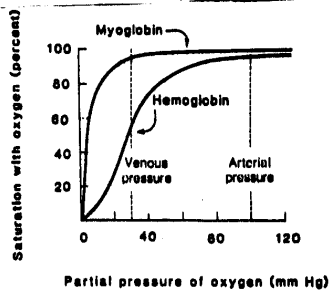

Oxygen saturation curve for hemoglobin and myoglobin

- **Sigmoidal curve:** describe the transport of O₂ from lung to tissues.
- a) The attachment of an O₂ molecule to one heme increases the oxygen affinity of the remaining heme groups in the same Hb molecule, (**cooperative binding**). This leads to subsequent binding of O₂ with higher affinity (the steep part of the curve) near 20-30 mm Hg partial pressure of O₂.
 - b) This allow Hb to deliver more O₂ to tissues in response to small changes in pO₂
 - 3) After release of O₂ at the tissues, Hb transport CO₂ from tissues to lungs.
 - a) CO₂ bind directly to Hb when O₂ is released.
 - b) CO₂ reacts with N-terminal of Hb forming **carbamate** and releasing protons (H⁺).
 - 4) Bohr effect:
 - a) H⁺ and CO₂ promote release of O₂ from Hb.
 - b) Presence of excess H⁺ & CO₂ in capillaries of metabolically active tissues promote the release of O₂ from oxy Hb.
 - c) The reverse of (b) occurs in alveolar air where excess O₂ will unload H⁺ & CO₂ from Hb.
 - d) Bohr effect
 - Tissues produce CO₂ during metabolism.
 - CO₂ is directly carried on Hb of RBCs.
 - In RBCs, carbonic anhydrase catalyses:

$$\text{CO}_2 + \text{H}_2\text{O} \xrightarrow{\text{Carbonic anhydrase}} \text{H}_2\text{CO}_3 \rightarrow \text{H}^+ + \text{HCO}_3^-$$
 - H⁺ immediatly binds to Hb followed by loss of O₂ (2H⁺ are bound to Hb for every 4O₂ molecules lost) → deoxy Hb.
 - In the lungs:

$$\text{O}_2 + \text{deoxy Hb} \rightarrow \text{H}^+ \text{ (the ionized H attached to the N- of distal histidine).}$$

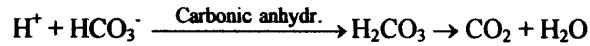

CO₂ is then expired in the lung (exhaled).

- There is unloading of O₂ in peripheral tissues and loading O₂ in the lungs.
- Deoxy Hb has greater affinity for protons than oxy Hb.
- Decrease in pH → Excess H⁺ → promotes more dissociation of O₂ from oxy Hb (**lower the affinity of Hb to O₂**).

Myoglobin:

- A) Occurs in the heart and skeletal muscles.
- B) Function: act as both reservoir for O₂ and O₂ carrier in muscles.
- C) Structure:
 - 1) Single polypeptide chain (globin) with one heme unit attached to it in a similar manner like Hb.
 - 2) Molecular weight = 17000; 153 am.ac. residues.
 - 3) Secondary and tertiary structures are similar to that of Hb.
 - 4) O₂ reversibly binds to it like Hb without simultaneous oxidation of ferrous ion.
 - 5) Oxygen saturation curve of myoglobin.
 - **Hyperbolic curve** (unlike sigmoidal curve for Hb).
 - a) Myoglobin has higher affinity for O₂ than Hb. → tight binding of O₂ → less dissociation → very low pO₂ (1 mm Hg) will make myoglobin half saturated with O₂ (Hb need 26 mm Hg pO₂ in order to be half saturated).
 - b) Myoglobin cannot deliver its O₂ to peripheral tissues since pO₂ = 40 - 20 mm Hg in the venous blood of them which will not allow O₂ to dissociate from myoglobin.
 - c) Severe muscular exercise → deprivation of O₂ (PO₂ = 5 mm Hg) → this allows O₂ to dissociate from myoglobin for the synthesis of ATP by muscle mitochondria.

MEMBRANES: Structure & function

Definition & importance:

1-Composed of phospholipids, sphingolipids, cholesterol, protein and carbohydrates. 2- Plasma membrane divides the inside of a cell from the outside (form closed compartment), provides the means for selective permeability and allows recognition and response to hormones. 3- Inside cells, membranes surround various organelles (mitochondrial, lysosomes, nucleus & peroxisomes) and connect with the plasma membranes through the endoplasmic reticulum and Golgi complex. 4- Membranes are also necessary for the electron transport chain, vision and transmission of nerve impulses.

Chemical composition:

A) Lipids:

1) **Phospholipids:** a) **Phosphoglycerides:** lecithin, cephalin (most common), cardiolipin (in mitochondril membrane) and lipositol (the phosphatidyl inositol) which is involved in hormone action. These lipids contain two fatty acids (one saturated and another unsaturated) with even number ($C_{16} - C_{18}$).

Thus they have a head (P + glyc + alcohol) and a tail (2F).

b) **Sphingomyelin** present in excess in myelin sheath. One fatty acid (saturated or unsaturated) is attached to sphingosine. Thus, like other phospholipids it has a head (P+ choline) and a tail (FA+ sphingosine).

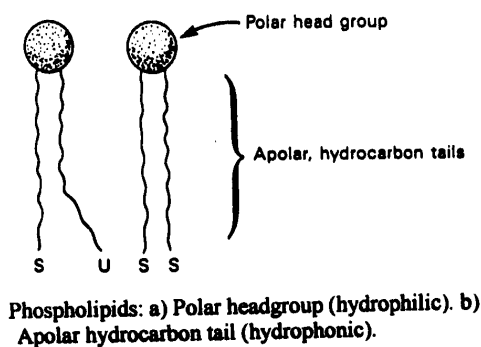
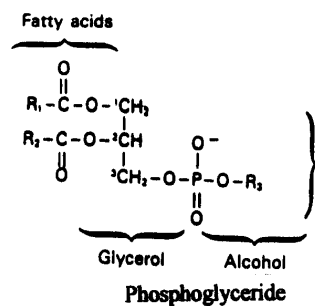

2) Glycosphingolipids (cerebrosides & gangliosides):

- They are minor components in cell membranes, most in brain tissues.
- They are part of cell receptors and antigens (blood groups). It is formed of ceramide (sphingosine +FA) attached to its carbohydrate residues (galactose, glucose and NANA) which are on the surface of membranes. They also have a head (carbohydrate) and a tail (FA+ sphingosine).

3) Cholesterol: The third major lipid in membranes. It is a compact, rigid & hydrophobic molecule (four fused rings and eight member branched hydrocarbon chain). It also has a polar OH group at C₃. It is present to a lesser extent in mitochondrial, Golgi complexes and nuclear membranes. It is more abundant on the outer surface of membranes.

B) Proteins:

- 1) Extrinsic proteins:** Present on the surface of membranes. They are enzymes, soluble in water and thus are easily released from membranes by treatment with salt solutions.
- 2) Intrinsic (integral) proteins:** They traverse the lipid layer of membranes by making strong hydrophobic bonds with them. However proteins are amphipathic (hydrophilic regions of proteins are located on the outer surface of membranes while their hydrophobic regions interact with the hydrophobic part of lipid bilayer) (refer to structure of membranes). They are not easily removed from membranes. They are enzymes, transport proteins, structural proteins, antigens (histocompatibility) and receptors.

C) Carbohydrates

- 1) They are oligosaccharides bound to proteins (glycoproteins) or lipids (glycosphingolipids or glycolipids).

Include: glucose, galactose, mannose, fucose, N. acetylglucosamine, N. acetylgalactosamine and sialic acid (NANA).

- 3) Present on the external surface of plasma membrane & have a role in cell - cell recognition, adhesion & receptor action.

Physicochemical properties of membrane lipids:

A) Amphipathic property : they contain both :

- 1) **Hydrophilic regions :** these are polar head groups (P+ glycerol+ alcohol).
- 2) **Hydrophobic regions:** these are apolar (nonpolar) tail groups (FA and sphingosine). Saturated FA are straight chains while unsaturated FA are kinked (cis form). More unsaturation of FA will allow for more kinks in the tail and membranes become more fluid.

B) Form lipid bilayer.

- 1) **Micelles formation** Amphipathic lipids in a solvent like water will organize themselves and interact with each other to form spheres (micelles). The hydrophobic tails interact & exclude water and charged polar head groups will be on the outside of the sphere immersed in water. This condition is most stable thermodynamically. Micelles are stable.

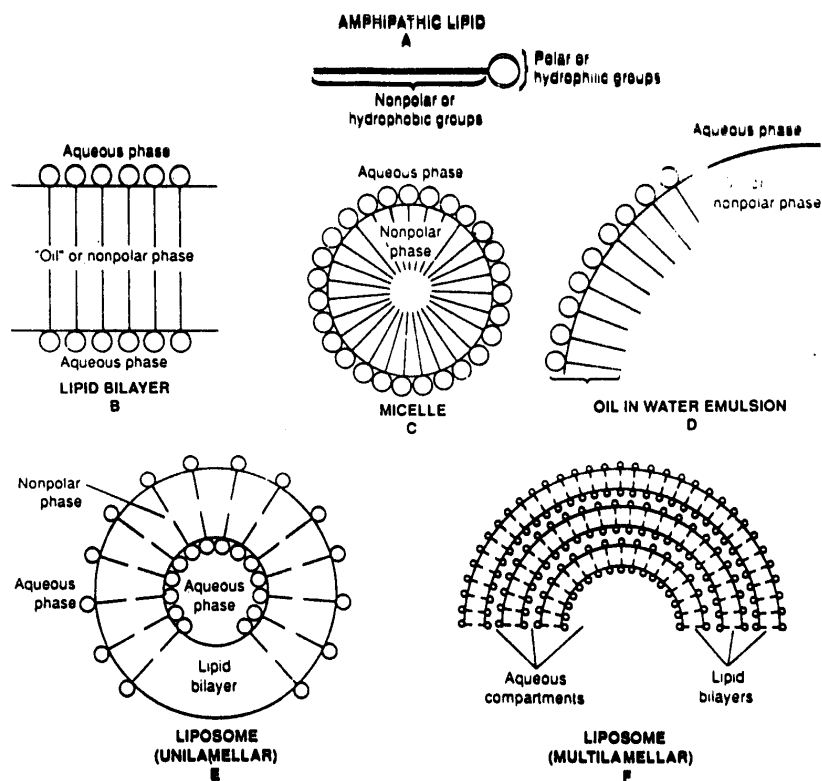

Formation of lipid membranes, micelles, emulsions and liposomes from amphipathic lipids, (phos pholipds).

2) Lipid bilayer formation:

- It is a further organization of amphipathic lipids in water.
- A bilayer can be formed which exists as a sheet in which the hydrophobic regions are protected from water environments, while the hydrophilic regions are immersed in water. This bilayer has exposed edges or ends.
- **Liposome** : It is a spherical vesicle of lipids formed by folding the two edges of lipid bilayer sheet.
- Self assembly of amphipathic lipids into bilayers is an important characteristic and is involved in the formation of cell membranes.

C) Fluidity of membranes:

- Lipid bilayers are stable but have fluidity due to lipids & proteins.
- Molecules move rapidly in their own layer (monolayer) but do not exchange with the nearest monolayer
- **Types of movement:** a). **Lateral:** individual phospholipid and proteins exchange places with neighboring molecules in the monolayer. b) **Rotation:** around the carbon – carbon bonds in FA.
- Cholesterol decreases fluidity (stiffing structure).
- Unsaturated FA have kinked tails and membranes become less tightly packed leading to more fluidity.

D) Self sealing:

- If disrupted, bilayers will self- seal because hydrophobic groups will seek to establish a structure in which there is minimal contact with water.

E) Selective permeability:

- 1) **Permeable to:** i) Gases (CO₂, O₂, N) pass through the hydrophobic region of bilayer. ii).Steroids : they are lipid derived.iii) Lipid soluble organic materials.2)**Impermeable to:** most water soluble molecules; they are insoluble in hydrophobic core of bilayer.

Structure of membranes (Fluid mosaic model)

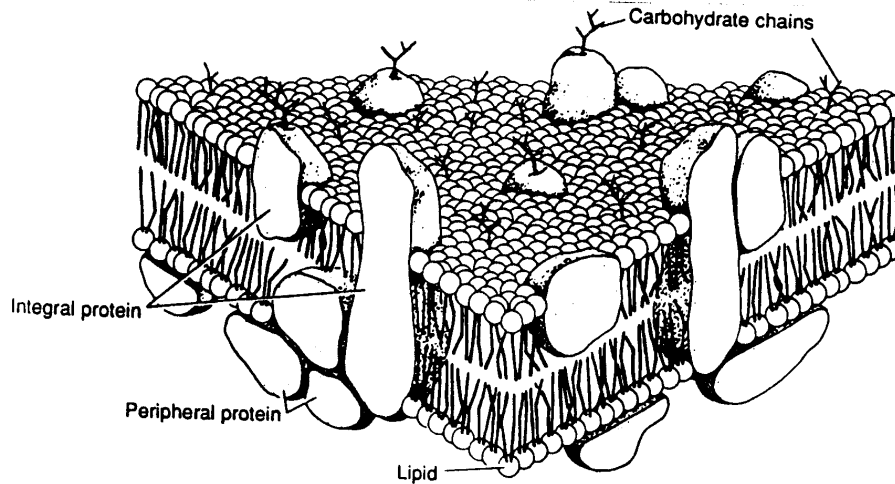

The fluid mosaic model of membrane structure. The membrane consists of a bimolecular lipid layer with proteins inserted in it or bound to the cytoplasmic surface. Integral membrane proteins are firmly embedded in the lipid layers. Some of these proteins completely span the bilayer and are called transmembrane proteins, while others are embedded in either the outer or inner leaflet of the lipid bilayer. Loosely bound to the outer or inner surface of the membrane are the peripheral proteins. Many of the proteins and lipids have externally exposed oligosaccharide chains

- Fluid mosaic model proposed by Singer & Nicolson (1972).
- All membranes have bilayers arrangement as liposomes.
- Amphipathic lipids & cholesterol are oriented so that:
 - 1) Hydrophobic portions interact, minimizing their contact with water.
 - 2) Polar head groups of lipid are at the interface with aqueous environment.
 - 3) Proteins are either immersed in the lipid bilayer (intrinsic) or are loosely attached to the surface of membranes (extrinsic).
- Some proteins traverse the lipid bilayer being in contact with the aqueous medium both out - & inside.
- This model explains the observed cellular movement including fluidity & flexibility, ability to self-seal & impermeability.

Membrane transport:

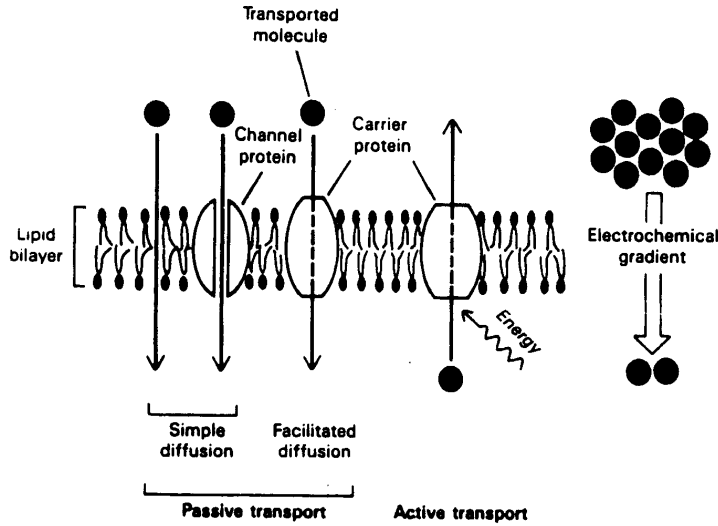

Many small uncharged molecules pass freely through the lipid bilayer. Charged molecules, larger uncharged molecules, and some small- uncharged molecules are transferred through channels or pores or by specific carrier proteins. Passive transport is always down an electrochemical gradient, toward equilibrium. Active transport is against an electrochemical gradient and requires an input of energy. Whereas passive transport does not.

There are several ways for the transport of molecules.

A) Passive transport:

1) Simple diffusion

- Small molecules pass passively in & out of membranes.
- These molecules are soluble in the lipid bilayer.
- Dependant on: i) Concentration gradient of the molecule (transport from high to lower concentration). ii) Lipid solubility of the substance. iii) Diffusion coefficient in lipids which is a function of shape and size of the substance iv).High temperature increases diffusion.
- Not energy dependant.
- **Examples:** a). Fatty acids, steroids (uncharged & lipophilic).
- b) Sugars & inorganic ions (water soluble) diffuse slowly.

2) Transport by channels (pores):

- Small molecules rapidly move (translocated) through an aqueous hole in membrane proteins in both directions.
- Channels have **gates**, which are transiently open or closed (**gated**).
- Gates are opened after contact with the substance in response to a change in membrane potential.
- Dependant on: i) Concentration gradient of the molecules ii) Electrical potential across the membrane .Solute move toward the opposite charge (inside of cells usually have negative charge iii) Permeability coefficient.
- Not energy dependant.
- **Examples:** Gases (O₂, CO₂, N), urea, ammonia, electrolytes.

3) Transport by protein transporters (facilitated diffusion):

- Small molecules are moved (translocated) across membranes by transporters (proteins) in both directions.
- Transporters bind the molecule in a specific way as in enzyme catalyzed reactions (but without chemical reaction).
- **Steps:** i). **Recognition** by transporter of specific molecule ii). **Translocation:** the protein transporter creates a channel for passage of solute which is controlled by gating mechanisms. Channels are created by conformational changes in the protein. iii). **Release** of solute into the other compartment if the latter has lesser concentration gradient than the initial site of binding
iv) **Recovery:** the original conformation gradient of the molecule is restored.
- Dependent on: i). Concentration gradient of the molecule ii). Presence of competitive inhibitors iii). Availability of carrier proteins.
- Not energy dependant
- **Examples:** Some monosacchaides, amino aids, and electrolytes.

B) Active transport

- 1) Similar to passive transport in that there is a specific transporter for every solute (sugar or amino acids).
- 2) Differ from passive transport in i) Unidirectional ii). Not dependant on concentration gradient of solute iii) Require energy from ATP (utilize about 30-40% of total energy expenditure in a resting individual).
- 3) ATP hydrolyses is performed by an ATPase (Na^+ , K^+ - ATPase) which Is an integral membrane protein ii) Has a requirement for Na^+ & K^+ iii) Acts as an active transporter to drive movement of ions

Examples :

a) Na^+ , K^+ pump:

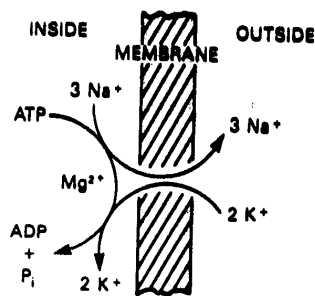

Na^+ , K^+ - ATPase pump

- It is the pump which maintains inside cells low Na^+ and high K^+ concentration.
- Na^+ , K^+ - ATPase has catalytic centers for Na^+ , ATP and K^+ . It hydrolyses ATP & use Na^+ , and K^+ as activators in the following reaction:

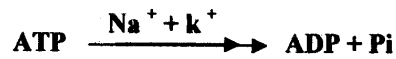

For each ATP utilized 3 Na⁺ are moved out of the cell but only 2 K⁺ in. This leads to an increase in outer positive charge.

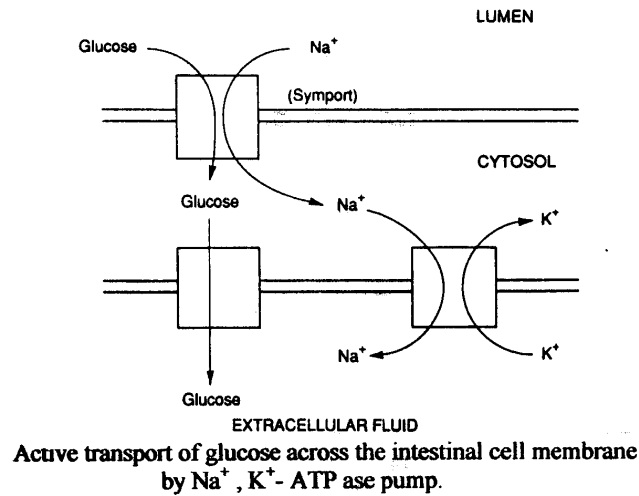

- **Function:** Transport of sugars and am. ac.
- Glucose (or am.ac.) have specific transporter.
- Na⁺ ion concentration in extracellular fluid is high.
- Glucose & Na⁺ bind to different sites on glucose transporter.
- Glucose is driven inside cells by the movement of Na⁺ down its concentration gradient (symport) without hydrolysis of ATP & by passive facilitated transport even against glucose concentration gradient.
- Na⁺ gradient is once more established in extracellular fluid by the Na⁺ / K⁺ pump —————> more glucose is driven by Na⁺ inside cells.
- Low Na⁺ gradient extracellularly inhibits glucose transport.

b) Calcium (Ca⁺⁺) transport:

- Ca⁺⁺ ion concentration is very low inside and high outside cells.

- Ca^{++} ion conc. inside cells can increase rapidly by opening of calcium channels (passive transport) initiated by a signal from some hormones (first messenger). Then Ca^{++} will mediate some metabolic functions of the hormone (Ca^{++} is a second messenger).
- Low cytosolic Ca^{++} levels are established again by a Ca^{++} transporter like that of, $\text{Na}^+ \text{K}^+ \text{ATPase}$ system by driving Ca^{++} outside cells at the end of hormone action.
- Calmodulin (Ca^{++} binding protein) binds Ca^{++} in cytosol & activate Ca^{++} transporter to increase calcium transport outside cells.

C) Transport of large molecules:

1) Endocytosis:

- It is the invagination of a segment of the plasma membrane. Endocytotic vesicle encloses the ingested macromolecule & part of extracellular fluid. Vesicle pinches off & plasma membrane seal.
- Vesicles fuse with lysosomal membranes and their contents are hydrolysed (digested). Requires energy (ATP) & Ca^{++} in extracellular fluid.



Exocytosis: Involves contact of 2 inside surfaces (cytoplasmic side).
 Endocytosis: Involves contact of 2 outer surface (extracellular side).

- Types:

a) Phagocytosis:

Occur in specialized cells (Macrophages)

- Macrophages internalize 3% of its plasma membrane every minute.

b) Pinocytosis:

- Cellular uptake of fluids in all cells.

- **Types:**

1) **Nonselective:** uptake of solutes by making vesicles.

2) **Selective:** Macromolecules will bind to its specific receptors on cell

surface → invagination of outer surface of membrane (pits) → vesicles fuse with lysosomes → macromolecules are digested but receptors are recycled again to membrane surface.

- **Example:** internalization of LDL lipoprotein and its receptor.

2) **Exocytosis:**

- It is the release of macromolecules to the exterior.
- Vesicles of intracellular organelle (E. reticulum & Golgi complex) containing synthesized components are exocytized after several signals are bound to cell surface receptors (hormones, neurotransmitters, immunoglobulins).
- **Examples:** i). Attachment of antigens to cell surface after its synthesis inside cells. ii) Transport of extracellular matrix (ECM) like collagen to outside cells. iii) Release of digestive enzymes, hormones or neurotransmitter outside cells after appropriate stimulation.

NUCLEOTIDES

Definition & importance:

Low molecular weight compounds formed of purine & pyrimidine bases (aromatic nitrogenous compounds), ribose (sugar) and phosphate. Major biochemical functions include DNA & RNA synthesis, energy metabolism (ATP), metabolic mediators (cAMP & cGMP), components of coenzymes, allosteric effectors and activated intermediates.

Structure:

A) General structure:

- Formed of purine or pyrimidine (base) + Ribose + phosphate.
- Base + ribose = nucleoside.
- Base + ribose + P = nucleotide.

B) Pyrimidine bases:

Parent compound is pyrimidine nitrogenous base (planar heterocyclic compound).

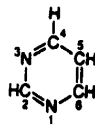

Pyrimidine

- Three main pyrimidines: Uracil (U), thymine (T) & cytosine (C).

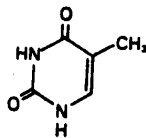

Thymine (T)
(2,4-dioxy-5-methylpyrimidine)

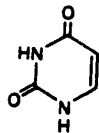

Uracil (U)
(2,4-dioxypyrimidine)

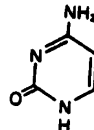

Cytosine (C)
(2-oxo-4-aminopyrimidine)

- Found in DNA & RNA (5-methyl- cytosine is a minor component of DNA).
- Show keto-enol tautomerism: the amino- & oxo-functional groups of aromatic ring exist in tautomeric equilibrium.

a) amino group: amino/imino pair (lactim/lactam form).

b) oxo group: enol/keto pair (Lactin/lactam form).

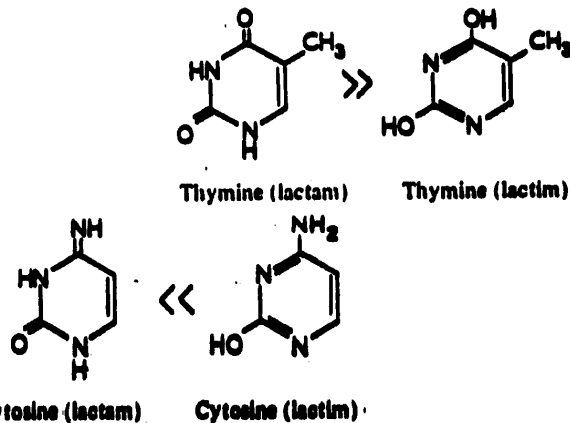

- Under physiological conditions either lactam or lactim forms predominate in DNA which is important for base pairing since it forms hydrogen bonds with another pair.

C) Purine bases:

- Parent compound is purine nitrogenous base (planar heterocyclic compound formed by fusion of 2 fused rings : pyrimidine & imidazole).
- Two main purines: Adenine (A) & Guanine (G).
- Found in DNA & RNA (hypoxanthine is a minor component of tRNA).
- Show keto-enol tautomeric forms with the same function as in pyrimidines.

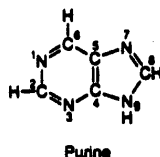

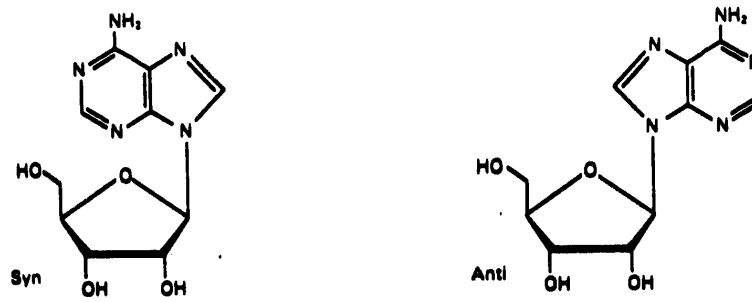

Nucleoside (Adenosine) showing Syn & Anti conformation.

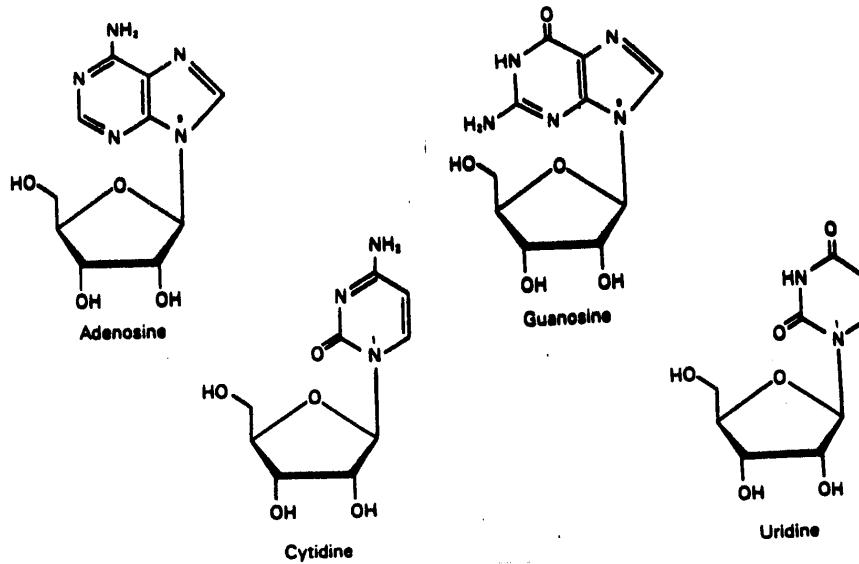

Structure of ribonucleosides (Syn conformation).

E) Nucleotides:

- Formed of base + ribose + phosphate.
- Base is attached to ribose by β -N-glycosidic linkage.
- Phosphate binds either to C₃ or C₅ of ribose by ester bond.
- If it contains ribose +1 phosphate . = nucleoside 5' phosphate.

1) Adenosine 5' monophosphate or adenylic acid (AMP).

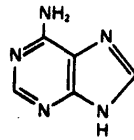

Adenine (A)
(6-aminopurine)

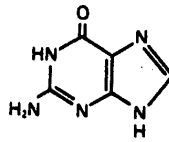

Guanine (G)
(2-amino-6-oxypurine)

- Hypoxanthine and xanthine are present free in cell and are intermediates in the Metabolism of adenine and guanine to uric acid (end product of purine catabolism).

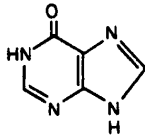

Hypoxanthine
(6-oxypurine)

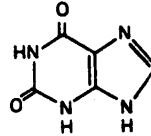

Xanthine
(2,6-dioxypurine)

- Methylated purines are found in food (plant origin):
 - a) Caffeine (1,3,7-trimethylxanthine) in coffee.
 - b) Theophylline (1,3 dimethylxanthine) in tea.
 - c) Theobromine (3,7 dimethyl xanthine) in coca.
- Caffeine, theoph. & theobro. have certain pharmacologic activity.

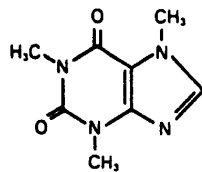

Caffeine
(1,3,7-trimethyl-xanthine)

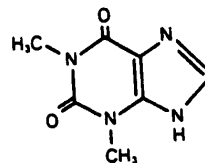

Theophylline
(1,3-dimethyl-xanthine)

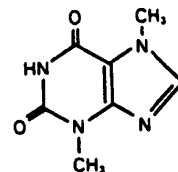

Theobromine
(3,7-dimethyl-xanthine)

D) Nucleosides:

- Formed of either pyrimidine (1 position) or purine (9 position) attached by β -N-glycosidic linkage with position 1 of ribose.
- If contains ribose = ribonucleosides.
If contains deoxyribose = deoxyribonucleosides.
- Show Syn & Anti conformations around the β -N-glycosidic bond due to absence of free rotation around that bond as a result of steric hinderance. Anti conformers predoninate which is essential for base pairing in DNA

2) Uridine 5' monophosphate or uridylic acid (UMP).

- If it contains ribose + 2 phosphate or 3 phosphate = nucleoside 5' di- or triphosphate. 1) Adenosine 5' di- & triphosphate (ADP & ATP).

2) Cytidine 5' di- & triphosphate (CDP & CTP).

- If it contains deoxyribose → deoxyadenosine 5' mono-, di- and triphosphate (dAMP, dADP, dATP, dCMP..... etc).

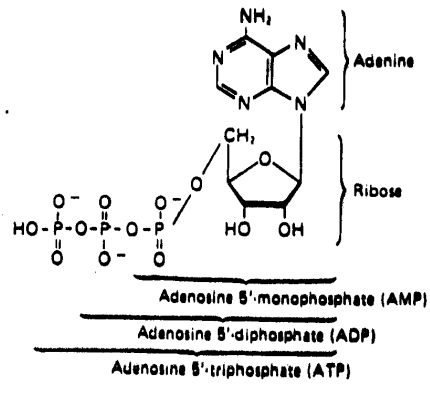
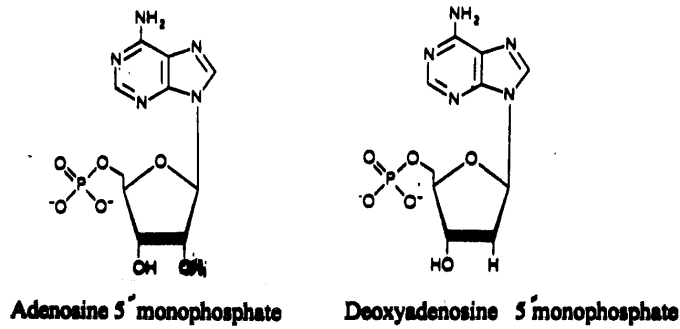

Principal bases, nucleosides, and nucleotides.

Base	Ribonucleoside	Ribonucleotide (5'-monophosphate)
Adenine (A)	Adenosine	Adenosine monophosphate (AMP)
Guanine (G)	Guanosine	Guanosine monophosphate (GMP)
Cytosine (C)	Cytidine	Cytidine 5'-monophosphate (CMP)
Uracil (U)	Uridine	Uridine 5'-monophosphate (UMP)
Base	Deoxyribonucleoside	Deoxyribonucleotide (5'-monophosphate)
Adenine (A)	Deoxyadenosine	Deoxyadenosine 5'-monophosphate (dAMP)
Guanine (G)	Deoxyguanosine	Deoxyguanosine 5'-monophosphate (dGMP)
Cytosine (C)	Deoxycytidine	Deoxycytidine 5'-monophosphate (dCMP)
Thymine (T)	Thymidine	Thymidine 5'-monophosphate (TMP)

- Cyclic forms of nucleotides like cyclic AMP & GMP (cAMP & cGMP) function as intracellular signals or secondary messengers during hormone action. They are synthesized from ATP or GTP, respectively.

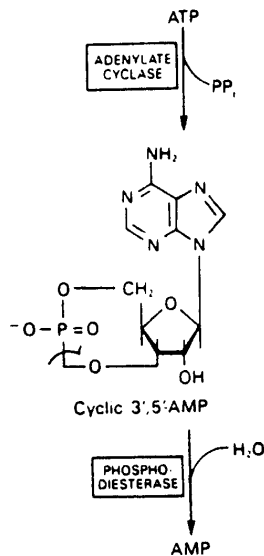

Cyclic AMP (cAMP): Synthesis & degradation

- Naturally there is:

- 1- Only uridine 5' mono-, di- & triphosphate (uridylic acid, UDP & UTP). UTP enters in RNA structure.
- 2- Only deoxythymidine 5' mono-, di-, & triphosphate (thymidylic acid, dTDP & dTTP). dTTP enters in DNA structure.

F) Properties of nucleotides:

- 1- Strong absorption of UV light (maximum absorption at 260 nm). UV absorption is used for assaying nucleotides in nucleic acids.
- 2- Easily hydrolyzed by dilute acid at 60°C → base + sugar + P.
- 3- Solubility in water due to presence of highly polar phosphate gr.

4- Purine & pyrimidine bases can be separated by thin layer chromatography, paper chromatography, electrophoresis & high performance liquid chromatography (HPLC).

Metabolic functions of nucleotides:

- 1) ATP synthesis: ATP is the principal source of energy available for muscle contraction, active transport & maintenance of ion gradients.
- 2) Nucleic acid synthesis (RNA & DNA): nucleoside 5' triphosphate.
- 3) Physiologic mediators:
 - cAMP & cGMP: act as second messenger for hormone action.
 - GTP: for capping of mRNA & in hormonal action.
 - ADP: for platelet aggregation & blood clotting.
- 4) Coenzyme formation: All NAD, NADP, FAD & CoA coenzymes have 5' AMP.

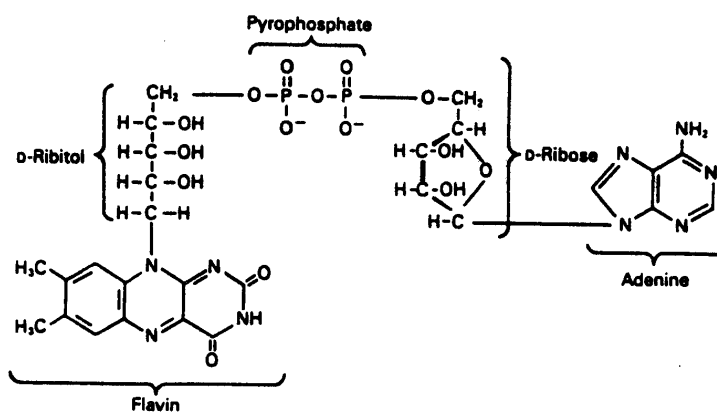

Flavin adenine dinucleotide (FAD).

- 5) Activated intermediates: they are carriers for:
 - UDP-glucose: for glycogen synthesis.
 - CDP choline & ethanolamine: for phospholipid synthesis.

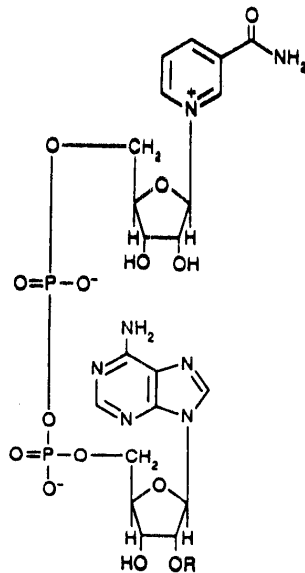

Nicotinamide adenine dinucleotide (NAD) coenzyme.

- GDP mannose and fucose, UDP galatose and CMP sialic acid are involved in glycoprotein synthesis.
- S-adenosylmethionine: for transmethylation reactions (noradrenaline → adrenaline).
- 3' phosphoadenosine -5' phosphosulfate (PAPS): for generation of sulfated molecules (proteoglycans).
- 6- Allosteric effectors: ATP, ADP, AMP and others regulate various metabolic pathways allosterically.

NUCLEIC ACIDS

Definition:

Polynucleotides produced by polymerization of either deoxyribonucleotides (DNA) or ribnucleotides (RNA).

DNA:

- A) **Importance:** It is the carrier of genetic informations in both eukaryotes & prokaryotes. This bank of information is preserved and passed from one

generation to the next over millions of years. DNA controls every aspect of cellular function, primarily through protein synthesis (enzymes, hormones, structural proteins ... etc).

B) Structure:

1) Chemical composition:

- Long chain of repeating mononucleotides bound by phosphodiester bonds.
- Four deoxynucleotides of adenine (A), guanine (G), cytosine (C) and thymine (T) (dAMP, dGMP, dCMP and thymidylic acid).
- Nucleotides are joined by 3',5' phosphodiester bonds: The 3' carbon of the first sugar is bound to the -OH of phosphate bound to 5' carbon of the second sugars (so the phosphate is attached to two sugars = 3',5' phosphodiester bonds). This 3',5' diester bonding continues in the direction 3' → 5' until all nucleotides are joined together.

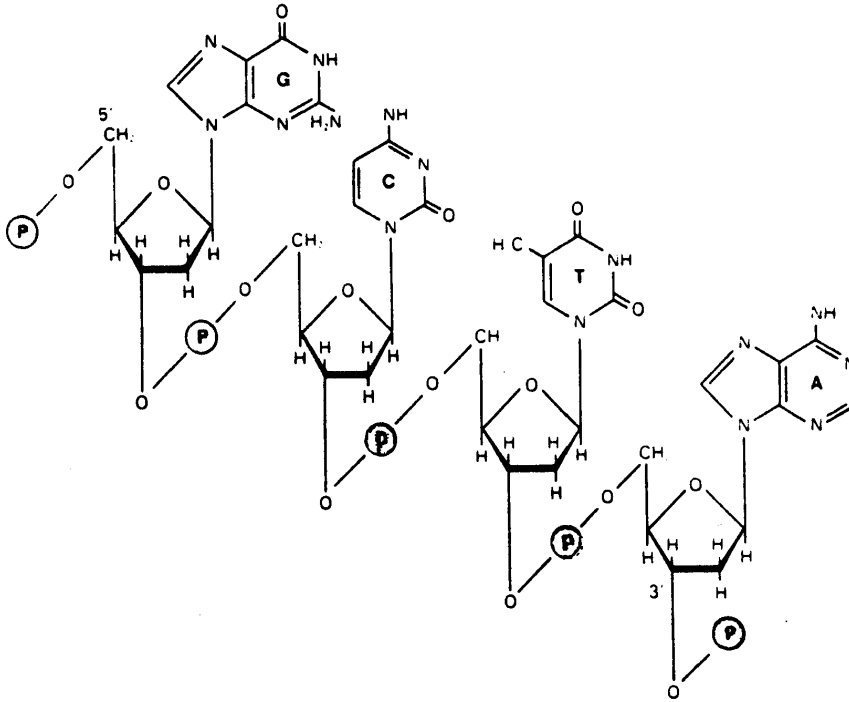

Part of DNA strand. Purine & pyrimidine bases are held by Phosphodiester bonds. Note polarity (direction).

- Nucleotides have 2 terminals: 5' terminal (start end) and 3' terminal (last nucleotide attached to the chain).
- The specific sequence of nucleotides on the chain determines its biological properties (DNA carry genes & genetic code).

2) DNA double helix:

- By Watson and Crick (1953).
- One polynucleotide strand tends to form a single helix.
- The double helix structure of DNA result from interwinding of two right-handed helical polynucleotides.

- Characteristics of DNA double helix:

- a) Like a coiled staircase (ladder) with a sugar-phosphate backbone facing outside and bases facing inside in a perpendicular manner to the backbone (perpendicular to the long axis of D. helix like steps of a staircase).

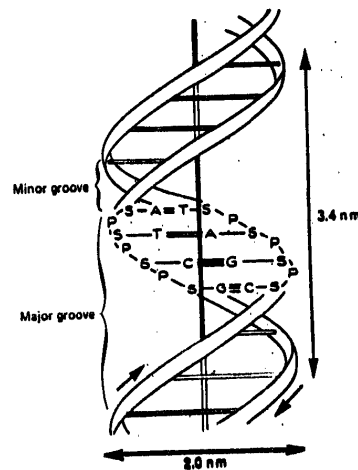

Double helical structure of DNA (width = 2.0 nm; length of one turn of the double helix = 3.4 nm). Strands are antiparallel.

- b) Bases tend to interact with one another due to their hydrophobic nature expelling water between them (stacked conformation).
- c) Double helix is stabilized by:

- i) Stacking conformation between bases.
- ii) Hydrogen bonds between complementary bases.
- d) Base pairing rule (or complementarity). Hydrogen bonds form between purine residue in one strand and pyrimidine residue on the other. Pairs are always adenine - thymine and guanine - cytosine (A-T & G-C).
- e) Two hydrogen bonds in A-T and 3 hydrogen bonds in G-C base pairs. G-C bond is stronger than A-T bond.

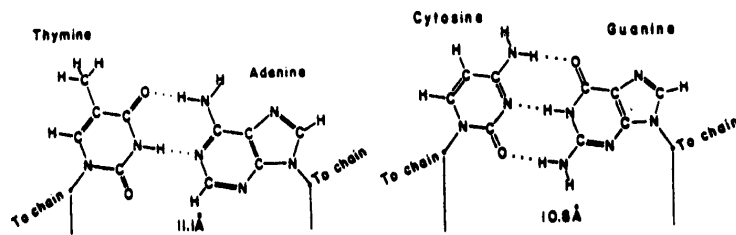

The base pairs of DNA.

- f) Concentration of A equals T and concentration of G equals C (Shargaff rule).
- g) Each strand has polarity and are antiparallel. Each strand runs opposite to one another: One in the 3' to 5' direction and the other in the 5' to 3' direction.
- h) Two strands are complementary to each other due to base pairing and complementarity rule. The genetic information reside in one strand (template strand) while the opposite strand is coding strand. Sometimes one strand has both template and coding regions.
- i) The double helix has:
 - Width = 2.0 nm, 10 base pair (bp) per turn, length of one turn = 3.4 nm.
 - Grooves winding along DNA molecule parallel to the phosphodiester bonds (major & minor grooves). In these grooves, proteins can interact specifically with bases without disrupting the base pairing.

- Negative charge due to the free acidic phosphate group on the outside of the helix which dissociate its protons at physiological pH. Therefore acidic DNA reacts with basic nucleoprotein (**histones**).

3) Different forms of DNA:

- Six forms: A, B, C, D, E & Z.
- B form predominates in the cell (right handed helix, 10 bp/turn).
- A form is similar to B form but more compact (11 bp/turn), and occurs in high salt environment.
- Z form is left handed helix, 12 bp/turn, thinner & longer than B form, phosphodiester bonds form zigzag and is present in some parts of DNA.

4) **Histones and nucleosomes:**

- DNA double strand helix of a genome in a cell is packaged into more compact form by a number of proteins (mostly basic proteins; histones).
- Histones a) basic: rich in arginine and lysine. b) positively charged (basic) and bind to the negatively charged DNA (acidic). c) they are five classes: H1, H2A, H2B, H3 and H4. d) DNA is wound around a core formed of 8 (octamer) molecules of 4 histones (two each of H2A, H2B, H3 and H4) with H1 is present on the surface. The interaction between histones & DNA form **nucleosomes**.

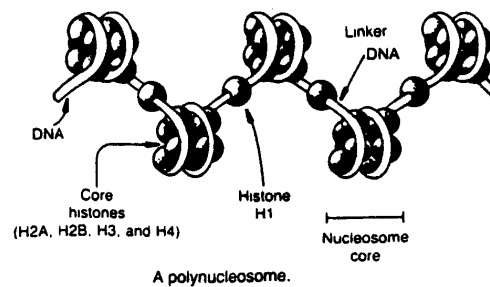

- Nucleosome: a) DNA double helix wound around an octamer of histones (2A, 2B, 3 & 4) with H1 on the surface of linker DNA. b) DNA helix form 1.75 super helix of 146 bp content around the histone octamer. c) Disc like structure 10 nm in diameter and 5 nm in height. d) linker DNA (<100 bp)

-links two nucleosomes forming **polynucleosome** structure like “**beads on a string**”.

C) DNA organization and packaging:

- 1) DNA of eukaryotes is associated with protein (**chromatin**).
- 2) Chromatin in resting nondividing cell is amorphous & dispersed.
- 3) There are 23 pairs (46) of **chromosomes** (diploid number) and each is formed of two sister **chromatids** united at centromeres.
- 4) Each sister chromatid has one DNA molecules with a length = 5 cm (1.8×10^8 bp).
- 5) DNA length of all 46 chromosomes = 2m = 7×10^9 bp = **human genome**.
- 6) Therefore the length of each DNA molecule must be compressed **8000 folds** to generate chromosomes at metaphase.
- 7) Packaging ratio:
 - i) DNA double helix = 1
 - ii) Nucleosome = 7 - 10.
 - iii) Superhelical nucleosomes = 40 - 60
 - iv) Chromosome = 8000.

D) Physicochemical properties:

Denaturation or **melting of DNA** is the separation of the two strands by heat (60°C) which disrupt hydrogen bonds. Denaturation leads to increased absorption of light at 260 nm (**hyperchromism**). Denaturation can be reversed at low temperature (**annealing**). These changes are important in recombinant DNA technology.

RNA:

A) Importance: It is formed from DNA by transcription by which the sequence of DNA is copied exactly into RNA. The primary role of RNA is in protein biosynthesis by a process termed translation.

B) Central dogma of molecular biology:

It is the overall process of information transfer in the cell:



Protein biosynthesis requires several types of RNA, all present in cytoplasm:

a) Messenger RNA, mRNA b) Ribosomal RNA, rRNA c) Transfer RNA, tRNA.

C) Structure:

- It is a polymer of ribonucleoside 5' monophosphate.
- The purines found are adenine (A) and guanine (G), the pyrimidines are cytosine (C) and uracil (u) (DNA has thymine instead of uracil).
- Nucleotides are joined by 3', 5' phosphodiester bonds and have 5' and 3' terminals like DNA.
- Eukaryotic RNA vary from 65-200000 nucleotides long.
- Nucleotide sequence is complementary to base sequence of only one strand of DNA (template strand).
- Molar ratio of A + U & G + C are not equal (unlike DNA).

DNA strands:

Coding	→ 5'-TGG AATTGTGAGCGGATAACAATTTGACACAGCATG-3'
Template	→ 3'-ACCTTACACTCGCCTATTGTTAAAGTGTGTCGTAC-5'
RNA transcript	5' pA UUGUGAGCGGAUACA AUUUCACACAGCAUG 3'

The RNA transcript with 5' → 3' polarity is complementary to the template strand (3' → 5' polarity).

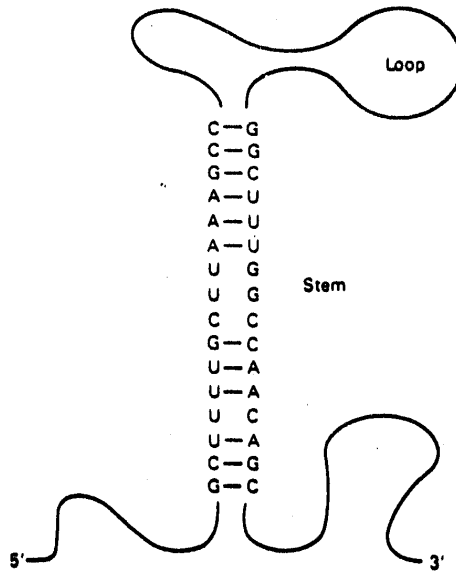

- Single strand double helix (secondary structure):

1) RNA strand is capable of folding back on itself like a hairpin and acquire **double-stranded characteristics**.

2) Folding occurs with proper bp complementarity (A-U & G-C).

D) RNA types (several organized structures):

1) **Messenger RNA (mRNA):**

- The most heterogeneous in size & stability. Synthesized in nucleus from DNA and carry genetic codes for protein biosynthesis on ribosomes.

- It is formed of **clstrons** (DNA sequence for polypeptide synthesis):

a) **Monocistronic:** carry information for one polypeptide (eukaryot).

b) **Polycistronic:** carry information for more than one polypeptide (prokaryots).

- Eukaryotic mRNA is capped to the first nucleotide by 7-methylguanosine & contain polyadenine tail attached to its last nucleotide.

-The cap and tail have two functions: a) Prevent the attack of 5' - exonucleases. b) Important for translation.

2) **Transfer RNA (tRNA):**

- About 75 nucleotides (low molecular weight).

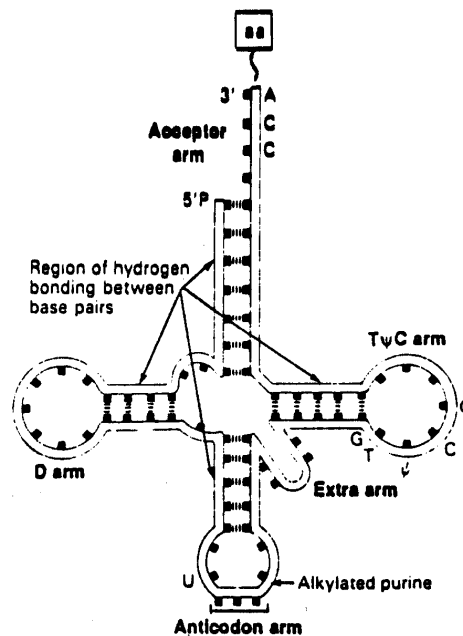

Secondary structure of tRNA that appears like a clover leaf with an amino acid (aa) is attached to the 3' ccA terminus (acceptor arm)

- Synthesized in the nucleus from DNA.
- They function in the cytosol and carry specifically amino acids and adapt them to the proper genetic code of mRNA during protein biosynthesis on ribosomes.
- There are at least 20 species (one for each am. ac).
- Secondary structure allow extensive folding that make tRNA appear like a **clover leaf** with several arms .
- Arms : a) Acceptor arm : CCA sequence at which the specific amino acid is attached through its carboxyl group. b) Anticodon arm recognizes the nucleotides of the codon (on mRNA) and is responsible for the specificity of t RNA.

3) Ribosomal RNA (rRNA):

- Protein synthesis occurs on ribosomes (80% of cellular RNA).
- mRNA & tRNA interact on ribosomes to translate into a specific protein molecule information transcribed from a gene.
- Mammalian ribosomes have 80S sedimentation velocity and contain **two subunits**: a) Big subunit (60 S): contain 5 S rRNA & 28 S rRNA. b) Small subunit (40 S): contain 18 S rRNA.
- Ribosomes have protein part (ribonucleoprotein). They are 83 proteins (49 on 60 S and 34 on 40 S subunits).
- Prokaryotic ribosomes are 70 S (40 S + 30 S subunits).

E) Differences between DNA & RNA:

		DNA	RNA
1.	Sugar	Deoxyribose	Ribose
2.	Bases	Contain thymine	Contain uracil
3.	Strands	Double	Single
4.	Helix	Complete	Incomplete
5.	Size	Big (million bp)	Smaller 100-1000 bp
6.	Function	Genetic information	Protein biosynthesis
7.	Site	Nucleus, mitochondria	Cytoplasm
8.	Base content	G = C & A = T	Not equal