

## In-Depth Analysis of Lining Designs for Several 420 kA Electrolytic Cells

Zhou Jianfei<sup>1</sup> and Marc Dupuis<sup>2</sup>

<sup>1</sup>Guiyang Aluminum Magnesium Design & Research Institute, Guiyang, Guizhou, China, 550081

<sup>2</sup>GeniSim Inc., 3111 Alger St., Jonquiere, Quebec, Canada, G7S 2M9

Keywords: aluminum, smelters, 420 kA, cell lining design, cell productivity, energy efficiency, lining life, safety

### Abstract

With the increase in market's demand and the development of technology, high amperage electrolytic cells in China have become widely used. In recent years, over 40 prototype cells each operating around 420 kA have been constructed. With different electricity prices in different regions and hence different cell heat balance requirements, a wide variety of lining design were tested, each having its advantages and disadvantages. This study aims to analyze and compare each lining design components in terms of cell productivity, energy efficiency, lining life and safety aspects in order to identify the most pertinent and rational design.

### Introduction

Currently with increasing market demands and technology development, GAMI's high-amperage aluminum electrolysis cell technology has gradually become widely used in China. In 2012-2013, there have been 4 to 5 potlines over 400 kA put into operation, each varying in cell lining design based on power price variation in different areas and different process requirements. As a result, GAMI's 420 kA cell technology is now available with various lining options. This study analyses and compares the various options in order to identify the optimum design of the four main cell lining zones from the angle of maximizing several cell characteristics: productivity, energy efficiency, lining life and safety aspects.

### The four main cell lining zones of high amperage cell

From the design aspect, the cell lining can be divided into four general areas: the side wall area at liquids level, the side wall area at block level (pier region), the side wall area at lower insulation level and the bottom insulation area, as shown in Figure 1.

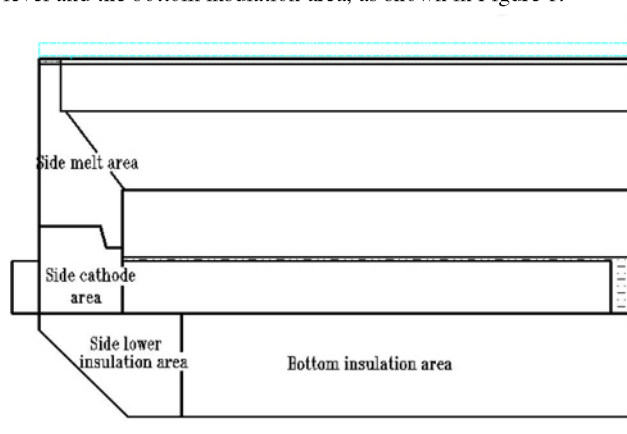

Figure 1: Pot lining zones [1]

### Summary and analysis on the lining areas

#### Side wall area at liquids level

The side wall area at liquids level is the key area of those four cell lining areas because the choice of design option and materials selection determines directly the corresponding operating voltage and cell ledge profile formation, thus influencing the process targets such as current efficiency, DC consumption, etc.

Based on experience, a reasonable side ledge profile should be as follows: ledge thickness at bath level around 8 to 10 cm, thickness of ledge at metal level approx. 3 to 5 cm, ledge toe thickness between 5 and 8 cm and upward crust thickness, less than 15 cm as shown in Figure 2.

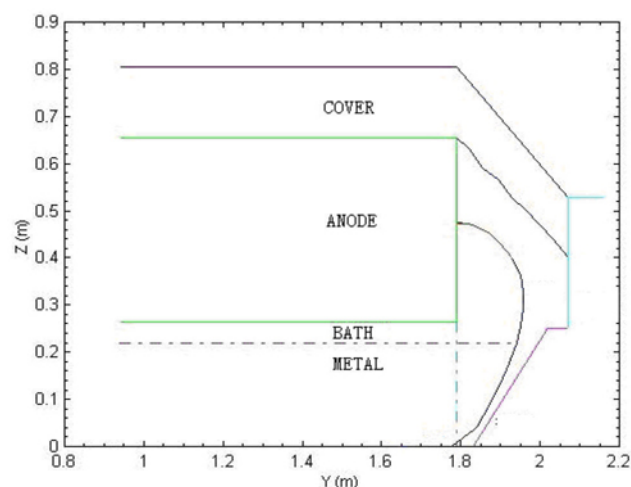
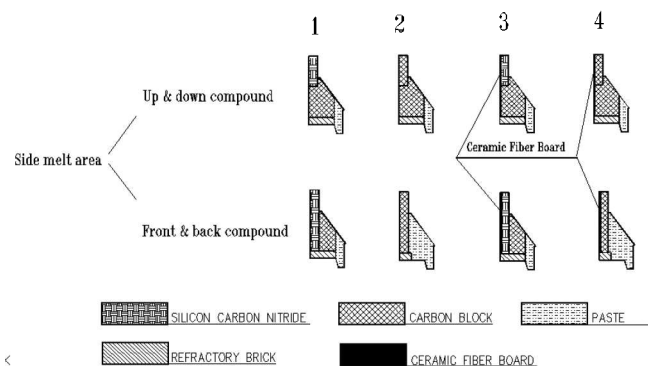

Figure 2: Optimum ledge profile

Currently the mainstream design topologies for this area cover top & bottom material combination and front & back material combination. There are four topologies options for each of those two main categories as shown in Figure 3.

The difference in the top & bottom material combination option 1 and 2 is that there is silicon carbide on top and profiled carbon block on the bottom for option 1 and carbon block on top and profiled carbon block on the bottom for option 2. For option 3 and 4, a ceramic fiber board insulation material is added on the option 1 and 2 respectively.

The front & back option 1 uses silicon carbide in the back and profiled carbon block in the front while option 2 uses side carbon block in the back and ramming pastes in the front. For option 3 and 4, a ceramic fiber board insulation material is added on the option 1 and 2 respectively.



**Figure 3: Side wall area at liquids level**

These eight design options for side wall area at liquids level have been analyzed from the angle of maximizing four cell characteristics.

**Top & bottom material combination or front & back material combination?**

Taking a position on this issue has been delayed for many years in China, but with the cell enlargement and low voltage production trend, new understanding has been given on those two main design topology options.

Traditionally, the slope area is all ramming paste which is the front & back material combination. The side profiled carbon block, which is the top & bottom material combination, has arisen in recent years. It is more convenient for construction compared to ramming pastes, and its heat conduction coefficient is twice that of ramming pastes. So it has good heat dissipation potential, and is also good for ledge formation on the slope. Taking a 420 kA cell operating at 0.78 A/cm<sup>2</sup> as an example, the ledge thickness on the slope of side profiled carbon blocks is 1 cm thicker than that of all ramming pastes. The details are shown in the following heat flux vector graphs of these two material combinations:

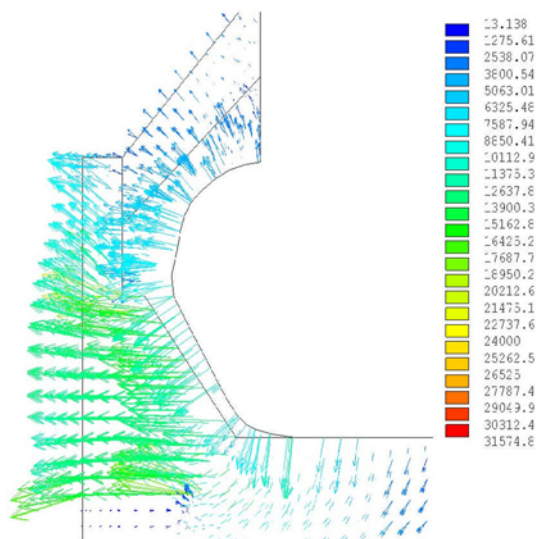

**Figure 4: Heat flux of side profiled carbon block**

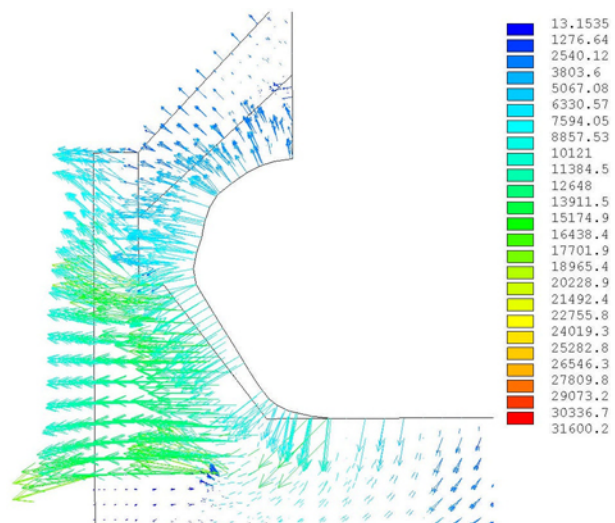

**Figure 5: Heat flux of side ramming paste**

As it can be observed in Figures 4 and 5, the difference between the heat flux distributions of side profiled carbon block and side ramming paste is minor, so the choice of material combinations should be based on ease of construction and ledge thickness requirement.

In general, many high amperage cells have the top hot and bottom cold trends in different degrees, for which the top & bottom material combination has a big advantage proven in practice.

**Adding or not side wall high insulation materials?**

Currently, there are four high thermal insulation materials used in China: ceramic fiber board, nano insulation board, vermiculite insulation board and hard calcium silicate board, which all have high heat insulation performance with heat conduction coefficients around 0.05-0.15 W/m<sup>2</sup>°C. For the present side wall insulation engineering application, the ceramic fiber board is the most widely used.

When the addition of high insulation materials is related with the cell operating voltage range, the following table with 420 kA cell operating at 0.78 A/cm<sup>2</sup> has been produced:

**Table 1**  
**Correspondence between high side insulation materials thickness and operating voltage**

Operating voltage (V)	4.0-4.1	3.9-4.0	3.8-3.9
High insulation materials thickness (mm)	0	6	10

If the cell is operated outside the ranges specified in the above table, the side ledge will be either too thick or too thin. The former will result in increasing metal pad horizontal current which will in turn lower the cell operating stability and make the cell more difficult to operate. The latter can result in cell leakage thus decreasing cell life and increasing safety risk.

In conclusion, the top & bottom material combination option 1 is recommended for side wall area at liquids level for the cell operating over 400 kA. Adding or not side wall high insulation material depends on the selected cell operating voltage range.

### Side wall area at block level (pier region)

There are two mainstream design options for the pier region at present, and they are as follow:



**Figure 6: Side wall area at block level**

With the prevailing low voltage cell operation, increasing the thermal insulation of the cell in order to prevent excessive ledge toe formation to get stable cell with high current efficiency is now the main design focus for the pier region.

It shall be said that option 1, the combination of low strength insulation bricks in the back plus high strength castable in front is the classic structure for the pier region. It is very mature and efficient in both preventing metal infiltration and reducing stress from the cathode sodium expansion. For the low voltage cell operation, 2 cm of ceramic fiber board is added on the outer wall of the low strength insulation bricks, i.e. the combination of ceramic fiber board in the back plus low strength insulation bricks in the middle plus high strength castable in front. That combination has proven over time its efficiency to obtain stable low voltage cell operation.

The difference between option 1 and option 2 lies in the addition of clay semi-insulating refractory bricks. Those bricks have a thermal conductivity of around 0.1~0.15 W/m<sup>2</sup>°C while the thermal conductivity of high strength castable is about 0.3~0.5 W/m<sup>2</sup>°C. So, option 2 has a bigger inhibition on the ledge toe formation. When considering a 420 kA cell operating at 0.78 A/cm<sup>2</sup> for example, the ledge toe of option 2 is about 2~3 cm shorter than that of option 1.

After actual verification on smelters operating using GAMI's cell technology, the cell current density has been increased steadily, so the inhibition of option 2 on ledge toe formation is now too much. Therefore, currently the semi-insulating refractory bricks in the pier region have been removed and option 1 is preferred again.

In conclusion, the option 1 is recommended for side wall area at block level (pier region) for cell operating over 400 kA.

### Adding or not side wall high insulation materials?

Overheated steel collector bars started to be observed in many large cells in recent years approaching 280 to 300 °C as can be seen in the Figure 7 infrared picture. This problem lead to reconsider whether the 2 cm ceramic fiber board was desirable or not at that location. As per calculation, the influence on steel collector bar temperature of the presence of that 2 cm ceramic fiber board is about 10 to 15 °C. Again adding or not side wall high insulation material depends on the selected cell operating voltage range.

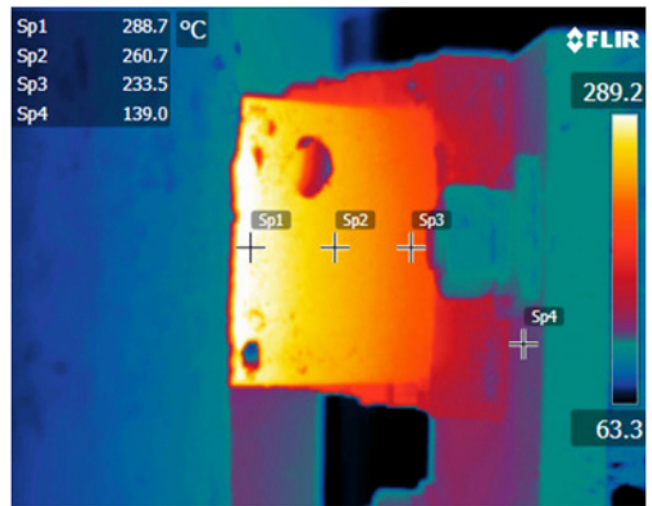
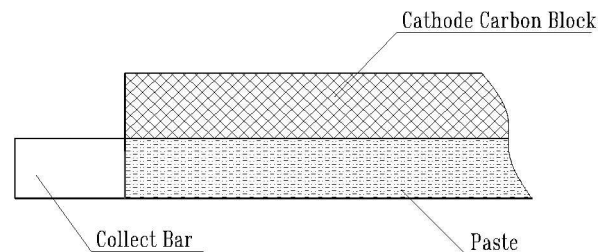

**Figure 7: Infrared picture from thermal imager for steel collector bar**

### Collector bar assembly

Another way to address the above overheated collector bar problem is to work on the collector bar assembly design. Double collector bars per block technology has now become very popular in China.

Typically ramming paste is used in China for the cathode block collector bar connection as follow:



**Figure 8: Full ramming paste connection**

Calculation of metal pad horizontal current for double collector bar connection for a 420 kA cell (current density  $0.78 \text{ A/cm}^2$ ) with bar section dimensions of  $230 \times 100 \text{ mm}$  have been made, the results are as shown below:

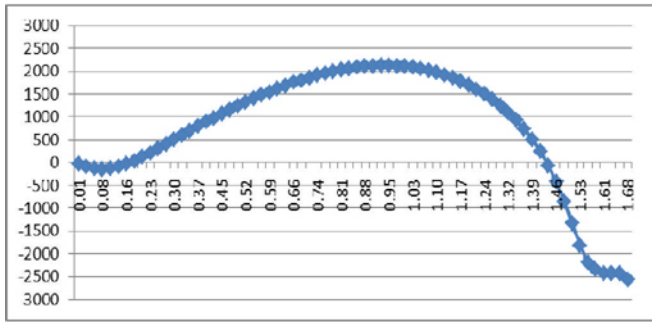

**Figure 9: Metal pad horizontal current density for full ramming paste connection**

Even with the ledge toe at its optimum position, this connection design generates intense horizontal currents in the metal pad which is bad for cell stability.

The usage of double bar technology is allowing the usage of partial ramming paste connection without changing too much the cathode voltage drop as compared to the single bar as follow:

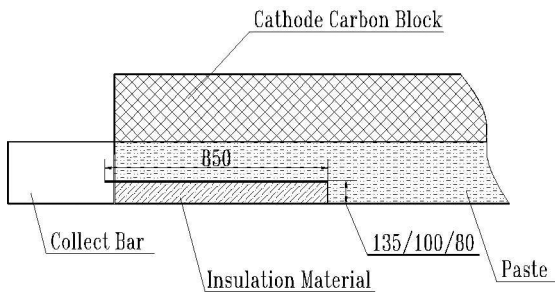

**Figure 10: Partial paste ramming connection [2]**

If the optimum height of 80 mm of insulation material is used, the maximum metal pad horizontal current is decreased to  $300 \text{ A/cm}^2$  as opposed to  $2200 \text{ A/cm}^2$  in the previous case and the average value under the anode is  $0 \text{ A/cm}^2$  as shown below:

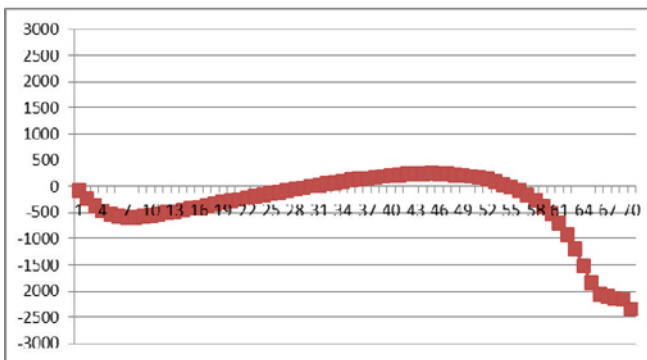

**Figure 11: Curve Partial paste ramming connection (insulation height 80)**

In conclusion, double steel collector bar is better to restrain horizontal current in order to reduce bath-metal interface fluctuation. This increases cell stability and current efficiency. This in turn allows to reduce the anode-cathode distance hence lowering the cell working voltage.

Among the studied partial paste ramming connection design, the one with the insulation part 80 mm high and 850 mm long prove to be optimal to reduce the metal pad horizontal current.

### Side wall area at lower insulation level

There is one mainstream design option for side wall area at lower insulation level at present, as follow:

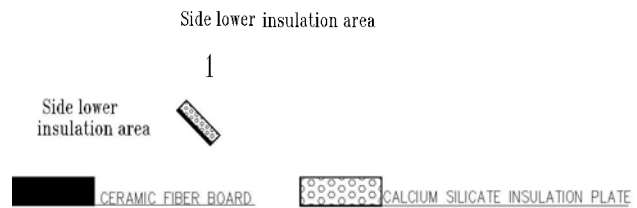

**Figure 12: Side wall area at lower insulation level**

The side lower thermal insulation influences directly the ledge toe extension. The design and choice of materials in this area has also an importance to prevent metal infiltration. After many years of trial and error on many projects, the relatively mature structure has been established, as shown in the above figure. Considering a 420 kA cell operating at  $0.78 \text{ A/cm}^2$  for example, that design option can reduce the ledge toe extension by 3~5 cm as compared to the traditional dry barrier only design option.

In conclusion, the option 1 is recommended for side wall area at lower insulation level for cells operating over 400 kA.

### Bottom insulation area

The cell bottom insulation area is not considered important to be able to decrease the cell heat loss in order to operate at lower cell voltage. Indeed, as the cell bottom area is not dissipating a big percentage of the total cell heat loss, it only represents about 6 to 9 % for GAMF's high amperage cell technology. Figure 13 illustrates a quite typical range that matches what has been reported in the literature [3].

Cell bottom insulation area is rather considered important for keeping the cathode surface relatively clean. Good cell bottom insulation can effectively prevent alumina and bath forming sludge piles on the cathode surface, which is good for preventing cathode drop increase caused by sludge. Hard crust will also form on the cathode surface if the duration of cold cell bottom is too long, which will cause abnormal cell operation, rapid decrease of current efficiency, even safety accidents of "metal boiling" etc. in extreme cases.

Many attempts, optimizations and laboratory tests have been made in China in recent years based on the specific concerned focus of proper cell bottom insulation. Optimum cell bottom insulation is of vital importance to safe and stable cell operation,

because enough bottom insulation is required to ensure good working conditions of cell bottom under low voltage, but excessive bottom insulation must also be avoided in order to prevent the isothermal curve to move too far down which increases safety accidents from cell leakages, etc.

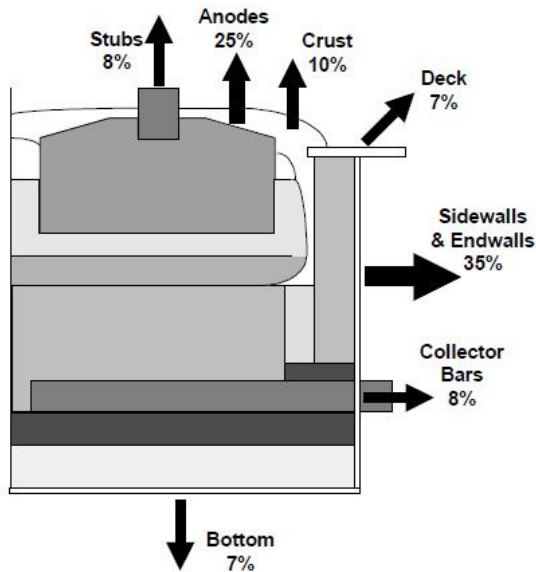

Figure 13: Typical heat loss partition of high amperage cell [3]

There are three mainstream design options for bottom insulation area at present, as follow:

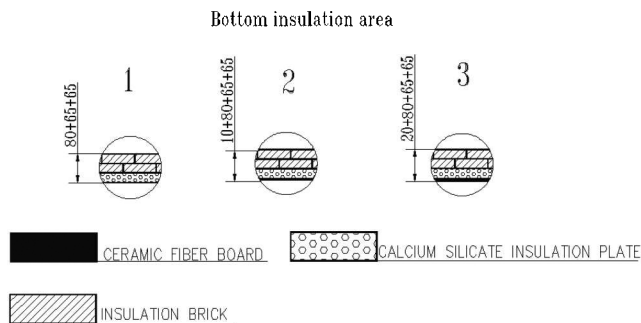

Figure 14: Bottom insulation area

Option 1 has 80 mm of calcium silicate board plus two rows of 65 mm of high strength insulating bricks from bottom to top. Considering a 420 kA cell (current density of 0.78 A/cm<sup>2</sup>, working voltage of 3.95 V) for example, the bottom heat dissipation is 9 % and the temperature on the top surface of the insulating brick is 800 °C.

Option 2 has 10 mm of ceramic fiber board plus 80 mm calcium silicate board plus two rows of 65 mm of high strength insulating brick from bottom to top. Taking the same 420 kA cell as an example, the bottom heat dissipation is 7 % and the temperature on the top surface of the insulating brick is 820 °C.

Option 3 has 20 mm of ceramic fiber board plus 80 mm calcium silicate board plus two rows of 65 mm of high strength insulating brick from bottom to top. For the same 420 kA cell, the bottom

heat dissipation is 6.5 % and the temperature on the top surface of the insulating brick is 825 °C.

Vermiculite insulating brick is used on the surface row in option 3 instead of diatomite insulating brick because vermiculite insulating brick has a better bath corrosion resistance than the diatomite brick. Figure 15 shows the results of a bath corrosion test.

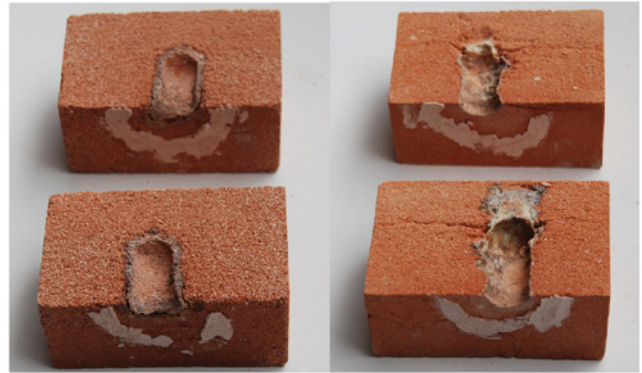

Figure 15: Results of vermiculite (left) and diatomite (right) insulating bricks corrosion test

For the vermiculite insulating brick, the hole diameter increased from 2 to 27 mm and the depth from 3 to 33 mm. The hole boundary is clear and bath corrosion was fully prevented. For the diatomite insulating brick, the hole diameter is increased from 5 to 30 mm and the depth from 30 to 60 mm. The brick was seriously corroded and that was accompanied by expansion and cracking. The results of the test clearly indicate that vermiculite insulating brick has a better bath corrosion resistance than that of diatomite insulating brick.

### Which option to use?

As the bottom insulation increases from option 1 to option 3, the bottom heat dissipation decreases by about 2 % which is not a big change for the cell heat balance. But the cathode surface increases by about 2 to 3 °C, which is very important for keeping cathode surface clean when the metal pad level is increased.

With the large-scale development of the cell, the aluminum metal pad level keeps getting higher and higher. This is required in order to get high enough current efficiency. The following table shows the relationship between cell current and metal pad level:

Table 2

### Relationship between metal pad level and cell current [1]

Current (kA)	300	350	400	420	500	600
Metal level (cm)	22	23	26	27	31	37

## References

- [1] Guo Hailing, "Research & Application of Pot Horizontal Current", IBAAS-CHALIECO International Symposium 2013 Proceedings.
- [2] Zhou Jianfei, "A Kind of Cathode Assembly to Improve the Pot Stability, Increase CE, Reduce the Energy Consumption and Prolong the Pot Life", Chinese Patent: 201020504034.
- [3] Jay Bruggeman, "Pot Heat Balance Fundamentals", Proc. 6<sup>th</sup> Aust. Al Smelting Workshop, 1998, 167-189.

It is shown from the Table 2 that the cells over 420 kA must be operated at a relatively high metal level. This means in turn that the bottom insulation must be increased in order to prevent the cathode surface to become too cold. The above three options are suitable for different voltage cases, as the following table indicates:

**Table 3**

**Relationship between the bottom insulation design option and the cell operating voltage**

<b>Operating voltage (V)</b>	4.05-4.15	3.95-3.85	3.75-3.85
<b>Applicable option</b>	Option 1	Option 2	Option 3

The above three options are recommended for bottom insulation area of the cells over 400 kA. Which is the most suitable depends on the operating voltage range.

## Conclusions

In general, the following recommendations and conclusions are given for design options selection on different lining areas for the cells over 400 kA:

- Side wall area at liquids level: the top & bottom material combination option 1 is recommended for side wall area at liquids level for cells operating over 400 kA. Adding or not side wall high insulation material depends on the selected cell operating voltage range.
- Side wall area at block level (pier region): the option 1 is recommended for side wall area at block level (pier region) of cells operating over 400 kA.
- Collector bar assembly: it is recommended to use double steel collector bar connection with insulation part 80 mm high and 850 mm long.
- Side wall area at lower insulation level: the option 1 is recommended for side wall area at lower insulation level for cells operating over 400 kA.
- Bottom insulation area: the above three options are recommended for bottom insulation area of cells over 400 kA. Which is the most suitable depends on the operating voltage range.