

الله  
رسول  
محمد

**BIOMIMETICS:**  
**TECHNOLOGY**  
**IMITATES**  
**NATURE**



**HARUN YAHYA**

Biomimetics means the imitation of living things in nature. This new study is being spoken of more and more often in technological circles and is opening up important new horizons for mankind.

As biomimetics emerges, imitating the structures of living systems, it presents a major setback for those who still support the theory of evolution. From an evolutionist's point of view, it's entirely unacceptable for men-whom they regard as the highest rung on the evolutionary ladder—to try to draw inspiration from (much less imitate) other living things which, allegedly, are so much more primitive than they are.

This book considers the advances that technology has made by taking nature as its model, and examines the flawless but hitherto, little noted systems that have existed ever since living things were first created. It also describes how nature's many varied and highly efficient mechanisms, which baffle the proponents of evolution, are all products of our Lord's unique creation.

### ABOUT THE AUTHOR



The author, who writes under the pen-name Harun Yahya, was born in Ankara in 1956. He studied arts at Istanbul's Mimar Sinan University, and philosophy at Istanbul University. Since the 1980s, the author has published many books on political, faith-related and scientific issues. Greatly appreciated all

around the world, these works have been instrumental in helping many to return their faith in God, and, in many others, to gain a deeper insight into their faith. Harun Yahya's books appeal to all kinds of readers, regardless of their age, race, or nationality, for they focus on one objective: to broaden the reader's perspective by encouraging him or her to think about a number of critical issues, such as the existence of God and His unity, and to live by the values He prescribed for them.

بِسْمِ اللَّهِ الرَّحْمَنِ الرَّحِيمِ

اللَّهُ  
رَسُولُ  
مُحَمَّدٍ

## TO THE READER

A special chapter is assigned to the collapse of the theory of evolution because this theory constitutes the basis of all anti-spiritual philosophies. Since Darwinism rejects the fact of creation—and therefore, God's Existence—over the last 140 years it has caused many people to abandon their faith or fall into doubt. It is therefore an imperative service, a very important duty to show everyone that this theory is a deception. Since some readers may find the chance to read only one of our books, we think it appropriate to devote a chapter to summarize this subject.

All the author's books explain faith-related issues in light of Qur'anic verses, and invite readers to learn God's words and to live by them. All the subjects concerning God's verses are explained so as to leave no doubt or room for questions in the reader's mind. The books' sincere, plain, and fluent style ensures that everyone of every age and from every social group can easily understand them. Thanks to their effective, lucid narrative, they can be read at one sitting. Even those who rigorously reject spirituality are influenced by the facts these books document and cannot refute the truthfulness of their contents.

This and all the other books by the author can be read individually, or discussed in a group. Readers eager to profit from the books will find discussion very useful, letting them relate their reflections and experiences to one another.

In addition, it will be a great service to Islam to contribute to the publication and reading of these books, written solely for the pleasure of God. The author's books are all extremely convincing. For this reason, to communicate true religion to others, one of the most effective methods is encouraging them to read these books.

We hope the reader will look through the reviews of his other books at the back of this book. His rich source material on faith-related issues is very useful, and a pleasure to read.

In these books, unlike some other books, you will not find the author's personal views, explanations based on dubious sources, styles that are unobscure of the respect and reverence due to sacred subjects, nor hopeless, pessimistic arguments that create doubts in the mind and deviations in the heart.



# **BIOMIMETICS:**

Technology Imitates

Nature

Translated by Carl Rossini

Edited by Tam Mossman

Published by

## **GLOBAL PUBLISHING**

Talatpasa Mah. Emir Gazi Cad.

Ibrahim Elmas Ismerkezi A Blok Kat.4

Okmeydani-Istanbul/Turkey

Phone: +90 212 2220088

Printed and bound by Secil Ofset in Istanbul

100. Yil Mah. MAS-SIT Matbaacilar Sitesi 4. Cadde No: 77

Bagcilar-Istanbul/Turkey

Phone: (+90 212) 629 06 15

All translations from the Qur'an are from *The Noble Qur'an: a New Rendering of its Meaning in English* by Hajj Abdalhaqq and Aisha Bewley, published by Bookwork, Norwich, UK. 1420 CE/1999 AH.

Abbreviation used:

(*pbuh*): Peace be upon him (following a reference to the prophets)

---

**www.harunyahya.com**



**BIOMIMETICS:**  
Technology Imitates  
Nature

**HARUN YAHYA**

March, 2006



# **CONTENTS**

**INTRODUCTION... 10**

**CHAPTER 1.  
INTELLIGENT MATERIALS... 18**

**CHAPTER 2.  
THE DESIGNS IN PLANTS AND  
BIOMIMETICS... 40**

**CHAPTER 3.  
GEARBOXES AND JET ENGINES IN  
NATURE... 56**

**CHAPTER 4.  
USING WAVES AND VIBRATIONS... 64**

**CHAPTER 5.  
LIVING THINGS AND FLIGHT  
TECHNOLOGY... 80**





**CHAPTER 6.  
WHAT WE CAN LEARN FROM ANIMALS... 102**

**CHAPTER 7.  
ORGANS SUPERIOR TO TECHNOLOGY... 124**

**CHAPTER 8.  
BIOMIMETICS AND ARCHITECTURE... 142**

**CHAPTER 9.  
ROBOTS THAT IMITATE LIVING THINGS..158**

**CHAPTER 10.  
TECHNOLOGY IN NATURE... 176**

**APPENDIX.  
DECEPTION OF EVOLUTION... 196**



***Introduction***



Imagine you've just bought an immensely detailed model airplane kit. How do you set about putting all the hundreds of tiny parts together? First, no doubt, you'll examine the illustrations on the box. Then, following the instructions inside shortens the whole process of putting a model together in the best way possible, making no mistakes.

Even lacking any assembly instructions, you can still manage the task if you already possess a similar model airplane. The first plane's design can serve as an important guide in assembling any later one. In the exact same way, using a flawless design in nature as a model provides shortcuts to designing technological equipment with the same functions in the most perfect possible manner. Aware of this, most scientists and research and development (R&D) experts study the examples of living things before embarking on any new designs, and imitate the systems and designs that already exist. In other words, they examine the designs God has created in nature and, then inspired, go on to develop new technologies.

This approach has given birth to a new branch of science: *biomimetics*, which means the imitation of living things in nature. This new study is being spoken of more and more often in technological circles and is opening up important new horizons for mankind.

As biomimetics emerges, imitating the structures of living systems, it presents a major setback for those scientists who still support the theory of evolution. From an evolutionist's point of view, it's entirely unacceptable for men—whom they regard as the highest rung on the evolutionary

ladder—to try to draw inspiration from (much less imitate) other living things which, allegedly, are so much more primitive than they are.

If more advanced living things take the designs of “primitive” ones as models, that means that we’ll be basing a large part of our future technology on the structure of those so-called lesser organisms. That, in turn, is a fundamental violation of the theory of evolution, whose logic maintains that living things too primitive to adapt to their environments soon became extinct, while the remaining “higher” ones evolved and succeeded.

Biomimetics, while placing the proponents of evolution in a vicious circle, is expanding by the day and coming to dominate scientific thought. In the light of this, yet another new scientific branch has emerged: biomimicry, or the science of imitating the behavior of living creatures.

This book considers the advances that biomimetics and biomimicry have made by taking nature as their model. It examines the flawless but hitherto, little noted systems that have existed ever since living things were first created. It also describes how nature’s many varied and highly efficient mechanisms, which baffle the proponents of evolution, are all products of our Lord’s unique creation.

### **What Is Biomimetics?**

Biomimetics and biomimicry are both aimed at solving problems by first examining, and then imitating or drawing inspiration from models in nature.

Biomimetics is the term used to describe the substances, equipment, mechanisms and systems by which humans imitate natural systems and designs, especially in the fields of defense, nanotechnology<sup>1</sup>, robot technology, and artificial intelligence (also known as AI, for short).

The concept of biomimicry, first put forth by Janine M. Benyus, a

writer and scientific observer from Montana, was later taken up and begun to be used by a great many others. One of their accounts describes her work and the whole development of biomimicry:

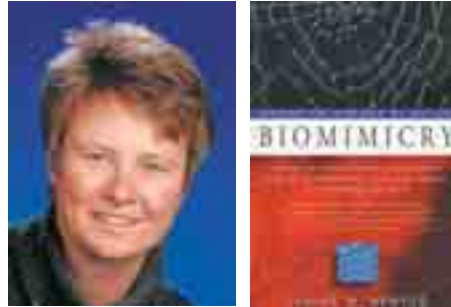

**Janine M. Benyus and her book *Biomimicry***

*A naturalist and author of several field guides to wildlife, she visited the laboratories of a number of scientific researchers who are taking a more modest approach to unraveling nature's secrets. The theme of "biomimicry" is that we have much to learn from the natural world, as model, measure, and mentor. What these researchers have in common is a reverence for natural designs, and the inspiration to use them to solve human problems.<sup>2</sup>*

David Oakey is a product strategist for Interface Inc., one of the firms making use of nature to improve product quality and productivity. On the subject of biomimicry, he has this to say:

*Nature is my mentor for business and design, a model for the way of life. Nature's system has worked for millions of years... Biomimicry is a way of learning from nature.<sup>3</sup>*

This rapidly expanding concept found favor with scientists, who were able to accelerate their own research by drawing for inspiration on nature's incomparably flawless models. Scientific researchers working on economic systems and raw materials—in the industrial field in particular—have now joined forces to determine how best to imitate nature.

Designs in nature ensure the greatest productivity for the least amount of materials and energy. They're able to repair themselves, are environmentally friendly and wholly recyclable. They operate silently, are pleasing in aesthetic appearance, and offer long lives and durability. All

these good qualities are being taken as models to emulate. As the journal *High Country News* wrote, “By using natural systems as models, we can create technologies that are more sustainable than those in use today.”<sup>4</sup>



Janine M. Benyus, author of the book *Biomimicry*, came to believe in the need for imitating nature by considering its perfections. Following are some of the examples she cites, which led her to defend such an approach:

- Hummingbirds' ability to cross the Gulf of Mexico on less than 3 grams of fuel,
- How dragonflies are more maneuverable than even the best helicopters,
- The heating and air conditioning systems in termite mounds—in terms of equipment and energy consumption, far superior to those constructed by man,
- Bats' high-frequency transmitter, far more efficient and sensitive than radar systems created by human beings,
- How light-emitting algae combine different chemical substances to give off light without heat,
- How arctic fish and temperate-zone frogs return to life after being frozen, with the ice doing their organs no harm,
- How anole lizards and chameleons change their colors—and how octopi and cuttlefish change both their colors and patterns in a moment—to blend in with their surroundings,
- Bees', turtles' and birds' ability to navigate without maps,
- Whales and penguins diving underwater for long periods without scuba gear,



- How the DNA helix stores information in all living things,
- How, through photosynthesis, leaves perform an astounding chemical reaction to create 300 billion tons of sugar every year.

These are just a few examples of the natural mechanisms and designs that create great excitement, and have the potential to enrich a great many areas of technology. As our information accumulates and technological possibilities increase, their potential becomes ever clearer.

In the 19<sup>th</sup> century, for example, nature was imitated only for its aesthetic values. Painters and architects of the time, influenced by the beauties of the natural world, duplicated these structures' external appearance in their own creations. But the deeper one looks into the fine detail, the more astonishing nature's immaculate order becomes. Gradually, as the extraordinary nature of natural designs and the benefits that their imitation would bring to mankind, natural mechanisms began to be studied more closely—and finally, at the molecular level.

The emerging materials, structures and machines being developed through biomimetics can be used in new solar cells, advanced robots and future spacecraft. From that perspective, nature's designs are opening incredibly broad horizons.

### **How Will Biomimetics Change Our Lives?**

Our Lord has given us the designs in nature as great blessings. Imitating them, taking them as models will direct mankind toward what is right and true. For some reason, only recently has the scientific community understood that nature's designs are an enormous resource and that these need to be made use of in daily life.

A great many authoritative scientific publications accept that natural structures represent a huge resource for showing mankind the way toward superior designs. *Nature* magazine expresses it in these terms:

*Yet fundamental research on the character of nature's mechanisms, from the elephant to the protein, is sure to enrich the pool from which designers and engineers can draw ideas. The scope for deepening this pool is still tremendous.<sup>5</sup>*

The correct use of this resource will certainly lead to a process of rapid developments in technology. Biomimetics expert Janine M. Benyus has stated that imitating nature will let us advance in a great many fields, such as food and energy production, information storage, and health. As examples, she cites mechanisms inspired by leaves, which work on solar energy; the production of computers that transmit signals the way cells do; and ceramics made to resist breakage by imitating mother-of-pearl.<sup>6</sup>

Therefore, it's evident that the Biomimetic Revolution will influence mankind profoundly and let us live in ever greater ease and comfort.

One by one, today's developing technologies are discovering the miracles of creation; and biomimetics is only one of the fields that's putting the extraordinary designs of living things to use as models in the service of mankind. A few of the scientific papers dealing with these matters include:

- "Learning from Designs in Nature"<sup>7</sup>
- "Projects at the Centre for Biomimetics"<sup>8</sup>
- "Science Is Imitating Nature"<sup>9</sup>
- "Life's Lessons in Design"<sup>10</sup>
- "Biomimicry: Secrets Hiding in Plain Sight"<sup>11</sup>
- "Biomimicry: Innovation Inspired by Nature"<sup>12</sup>
- "Biomimicry: Genius that Surrounds Us"<sup>13</sup>
- "Biomimetics: Creating Materials From Nature's Blueprints"<sup>14</sup>
- "Engineers Ask Nature for Design Advice"<sup>15</sup>

Perusing articles like these demonstrates how the results of this scientific research are, one by one, revealing proofs of the existence of God.



## INTELLIGENT DESIGN, IN OTHER WORDS CREATION

### **In order to create, God has no need to design**

It's important that the word "design" be properly understood. That God has created a flawless design does not mean that He first made a plan and then followed it. God, the Lord of the Earth and the heavens, needs no "designs" in order to create. God is exalted above all such deficiencies. His planning and creation take place at the same instant.

Whenever God wills a thing to come about, it is enough for Him just to say, "Be!"

As verses of the Qur'an tell us:

**His command when He desires a thing is just to say to it, "Be!" and it is. (Qur'an, 36: 82)**

**[God is] the Originator of the heavens and Earth. When He decides on something, He just says to it, "Be!" and it is. (Qur'an, 2: 117)**

Chapter 1.

# INTELLIGENT MATERIALS





Currently, many scientists are studying the structure of natural materials and using them as models in their own research, simply because these structures possess such sought-after properties as strength, lightness and elasticity. For example, the inner shell of the abalone is twice as resistant as the ceramics that even advanced technology can produce. Spider silk is five times stronger than steel, and the adhesive that mussels use to moor themselves to rocks maintains its properties even underwater.<sup>16</sup>

Gulgun Akbaba, a member of the Turkish *Bilim ve Teknik* (Science and Technology) Magazine research and publication group, speaks of the superior characteristics of natural materials and the ways in which we can make use of them:

*Traditional ceramic and glass materials have become unable to adapt to technology, which improves almost with every passing day. Scientists are [now] working to fill this gap. The architectural secrets in the structures in nature have slowly begun to be revealed... In the same way that a mussel shell can repair itself or a wounded shark can repair damage to its skin, the materials used in technology will also be able to renew themselves.*

*These materials which are harder, stronger, more resistant and have superior physical, mechanical, chemical and electromagnetic proper-*





*ties, possess lightness and the ability to withstand high temperatures required by such vehicles as rockets, space shuttles, and research satellites when leaving and entering the Earth's atmosphere. Work on the giant supersonic passenger carriers planned for intercontinental travel also requires light, heat-resistant materials. In medicine, the production of artificial bone requires materials that combine spongy appearance with hard structure, and tissue as close as possible to that found in nature.<sup>17</sup>*

To produce ceramic, used for a wide range of purposes from construction to electrical equipment, temperatures greater than 1,000-1,500°C (1,830-2,730°F) are generally needed.

Several ceramic materials exist in nature, yet such high temperatures are never used to create them. A mussel, for instance, secretes its shell in a perfect manner at only 4°C (39°F). This example of nature's superior creation drew the attention of Turkish scientist Ilhan Aksay, who turned his thoughts to wondering how we might produce better, stronger, useful and functional ceramics.

Examining the internal structures of the shells of a number of sea creatures, Aksay noticed the extraordinary properties of abalone shells. Magnified 300,000 times with an electron microscope, the shell resembled a brick wall, with calcium carbonate "bricks" alternating with a protein "mortar." Despite calcium carbonate's essentially brittle nature, the shell was extremely strong due to its laminated structure and less brittle than man-made ceramics. Aksay found that its lamination helps keep cracks from propagating, in roughly the



same way that a braided rope doesn't fail when one single strand breaks.<sup>18</sup>

Inspired by such models, Aksay developed some very hard, resistant ceramic-metal composites. After being tested in various US Army laboratories, a boron-carbide/aluminum composite he helped develop was used as armor plating for tanks!<sup>19</sup>

In order to produce biomimetic materials, today's scientists are carrying out research at the microscopic level. As one example, Professor Aksay points out that the bioceramic-type materials in bones and teeth are formed at body temperature with a combination of organic materials such as proteins, and yet possess properties much superior to those of man-made ceramics. Encouraged by Aksay's thesis that natural materials' superior properties stem from connections at the nanometric level (one-millionth of a millimeter), many companies aiming to produce micro-tools at these dimensions have embarked on bio-in-

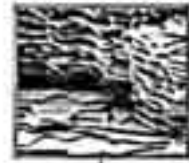

**Abalone shell consists of microscopic bricks in a layered structure that prevents any cracks in the shell from spreading.**

**Coral rivals the mussel shell's mother-of-pearl in terms of solidity. Using the calcium salts from seawater, coral forms a hard structure capable of slicing through even steel ships' hulls.**



spired materials—that is, artificial substances inspired by biological ones.<sup>20</sup>

All too many industrial products and byproducts, produced under conditions of high pressures and temperatures, contain harmful chemicals. Yet nature produces similar substances under what might be described as “life-friendly” conditions—in water-based solutions, for example, and at room temperature. This represents a distinct advantage for consumers and scientists alike.<sup>21</sup>

Producers of synthetic diamonds, designers of metal alloys, polymer scientists, fiber optic experts, producers of fine ceramic and developers of semi-conductors all find applying biomimetic methods to be the most practical. Natural materials, which can respond to all their needs, also display enormous variety. Therefore, research experts in various fields—from bullet-proof vests to jet engines—imitate the originals found in nature, replicating their superior properties by artificial means.

**The U.S. Army subjected the substance inspired by the abalone to various tests and later used it as armor on tanks.**





A great many substances in nature possess features that can be used as models for modern inventions. On a gram-for-gram basis, for example, bone is much stronger than iron.

Man-made materials eventually crack and shatter. This requires replacement or repairs, carried out with adhesives, for instance. But some materials in nature, such as the mussel's shell, can be repaired by the original organisms. Recently, in imitation, scientists have begun development of substances such as polymers and polycyclates, which can renew themselves.<sup>22</sup> In the search to develop strong, self-renewing bio-inspired materials, one natural substance taken as a model is rhinoceros horn. In the 21<sup>st</sup> century, such research will form the basis of material science studies.

### Composites

Most of the materials in nature consist of composites. Composites are solid materials that result when two or more substances are combined to form a new substance possessing properties that are superior to those of the original ingredients.<sup>23</sup>

The artificial composite known as fiberglass, for instance, is used in boat hulls, fishing rods, and sports-equipment materials such as bows

and arrows. Fiberglass is created by mixing fine glass fibers with a jelly-like plastic called polymer. As the polymer hardens, the composite substance that emerges is light, strong and flexible. Altering the fibers or plastic substance used in the mixture also changes the composite's properties.<sup>24</sup>

Composites consisting of graphite and carbon fibers are among the ten best engineering discoveries of the last 25 years. With these, light-structured composite materials are designed for new planes, space shuttle parts, sports equipment, Formula-1 racing cars and yachts, and new discoveries are quickly being made. Yet so far, manmade composites are much more primitive and frail than those occurring naturally.

Like all the extraordinary structures, substances and systems in nature, the composites touched on briefly here are each an example of God's extraordinary art of creation. Many verses of the Qur'an draw attention to the unique nature and perfection of this creation. God reveals the incal-



Thanks to their superior properties, light composite materials are used in a wide number of purposes, from space technology to sports equipment.



culable number blessings imparted to mankind as a result of His incomparable creation:

**If you tried to number God's blessings, you could never count them. God is Ever-Forgiving, Most Merciful. (Qur'an, 16: 18)**



### **Fiberglass Technology in Crocodile Skin**

The fiberglass technology that began to be used in the 20<sup>th</sup> century has existed in living things since the day of their creation. A crocodile's skin, for example, has much the same structure as fiberglass.

Until recently, scientists were baffled as to why crocodile skin was impervious to arrows, knives and sometimes, even bullets. Research came up with surprising results: The substance that gives crocodile skin its special strength is the collagen protein fibers it contains. These fibers have the



property of strengthening a tissue when added to it. No doubt collagen didn't come to possess such detailed characteristics as the result of a long, random process, as evolutionists would have us believe. Rather, it emerged perfect and complete, with all its properties, at the first moment of its creation.

### Steel-Cable Technology in Muscles

Another example of natural composites are tendons. These tissues, which connect muscles to the bones, have a very firm yet pliant structure, thanks to the collagen-based fibers that make them up. Another feature of tendons is the way their fibers are woven together.

Ms. Benyus is a member of the teaching faculty at America's Rutgers University. In her book *Biomimicry*, she states that the tendons in our muscles are constructed according to a very spe-

The load-bearing cables in suspension bridges are composed of bundles of strands, just like our muscles.

Bunch of cables

Cable wire

Load bearing cable

Muscle

Muscle fiber

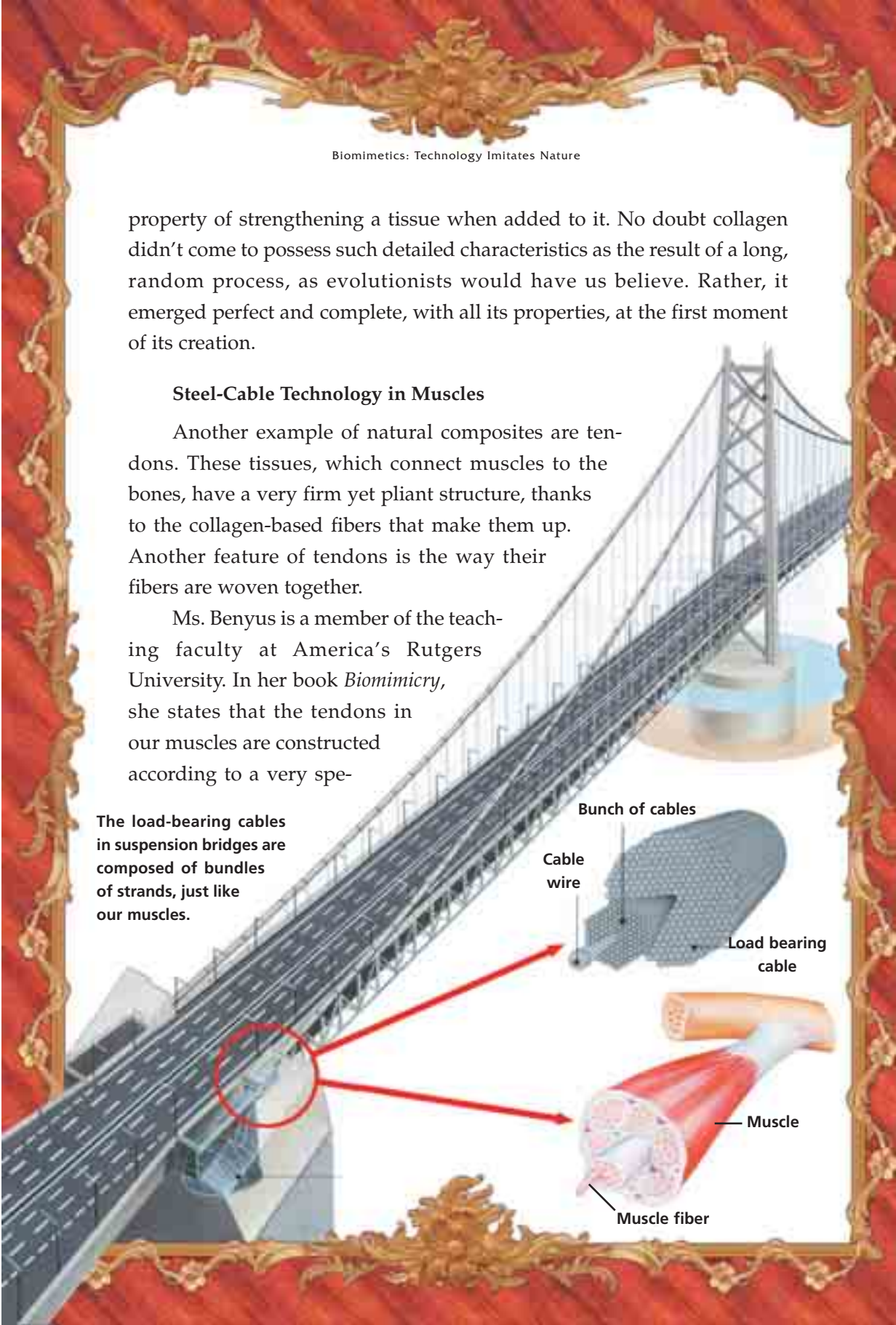

cial method and goes on to say:

*The tendon in your forearm is a twisted bundle of cables, like the cables used in a suspension bridge. Each individual cable is itself a twisted bundle of thinner cables. Each of these thinner cables is itself a twisted bundle of molecules, which are, of course, twisted, helical bundles of atoms. Again and again a mathematical beauty unfolds, a self-referential, fractal kaleidoscope of engineering brilliance.<sup>25</sup>*

In fact, the steel-cable technology used in present-day suspension bridges was inspired by the structure of tendons in the human body. The tendons' incomparable design is only one of the countless proofs of God's superior design and infinite knowledge.

#### **Multi-Purpose Whale Blubber**

A layer of fat covers the bodies of dolphins and whales, serving as a natural flotation mechanism that allows whales to rise to the surface to



breathe. At the same time, it protects these warm-blooded mammals from the cold waters of the ocean depths. Another property of whale blubber is that when metabolized, it provides two to three times as much energy as sugar or protein. During a whale's nonfeeding migration of thousands of kilometers, when it is unable to find sufficient food, it obtains the needed energy from this fat in its body.



**Whale blubber**

Alongside this, whale blubber is a very flexible rubberlike material. Every time it beats its tail in the water, the elastic recoil of blubber is compressed and stretched. This not only provides the whale with extra speed, but also allows a 20% energy saving on long journeys. With all these properties, whale blubber is regarded as a substance with the very widest range of functions.

Whales have had their coating of blubber for thousands of years, yet only recently has it been discovered to consist of a complex mesh of collagen fibers. Scientists are still working to fully understand the functions of this fat-composite mix, but they believe that it is yet another miracle product that would have many useful applications if produced synthetically.<sup>26</sup>

### **Mother-of-Pearl's Special Damage-Limiting Structure**

The nacre structure making up the inner layers of a mollusk shell has been imitated in the development of materials for use in super-tough jet engine blades. Some 95% of the mother-of-pearl consists of chalk, yet thanks to its composite structure it is 3,000 times tougher than bulk chalk.

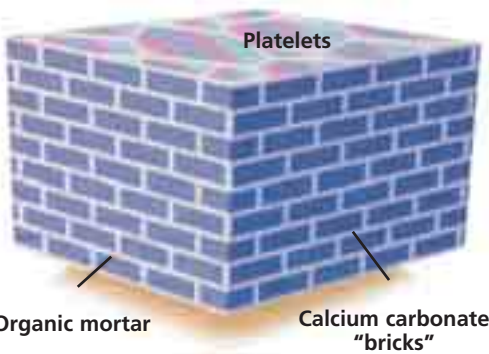

When examined under the microscope, microscopic platelets 8 micrometers across and 0.5 micrometers thick can be seen, arranged in layers (1 micrometer =  $10^{-6}$  meter). These platelets are composed of a dense and crystalline form of calcium carbonate, yet they can be joined together, thanks to a sticky silk-like protein.<sup>27</sup>

This combination provides toughness in two ways. When mother-of-pearl is stressed by a heavy load, any cracks that form begin to spread, but change direction as they attempt to pass through the protein layers. This disperses the force imposed, thus preventing fractures. A second strengthening factor is that whenever a crack does form, the protein layers stretch out into strands across the fracture, absorbing the energy that would permit the cracks to continue.<sup>28</sup>

The internal structure of mother-of-pearl resembles a brick wall and consists of platelets held together with organic mortar. Cracks caused by impacts change direction as they attempt to pass through this mortar, which stops them in their tracks. (Julian Vincent, "Tricks of Nature," *New Scientist*, 40.)

The structure that reduces damage to mother-of-pearl has become a subject of study by a great many scientists. That the resistance in nature's materials is based on such logical, rational methods doubtlessly indicates the presence of a superior intelligence. As this example shows, God clear-

ly reveals evidence of His existence and the superior might and power of His creation by means of His infinite knowledge and wisdom. As He states in one verse:

**Everything in the heavens and everything in the earth belongs to Him. God is the Rich Beyond Need, the Praiseworthy. (Qur'an, 22: 64)**

### **The Hardness of Wood Is Hidden in Its Design**

In contrast to the substances in other living things, vegetable composites consist more of cellulose fibers than collagen. Wood's hard, resistant structure derives from producing this cellulose—a hard material that is not soluble in water. This property of cellulose makes wood so versatile



in construction. Thanks to cellulose, timber structures keep standing for hundreds of years. Described as tension-bearing and matchless, cellulose is used much more extensively than other building materials in buildings, bridges, furniture and any number of items.

Because wood absorbs the energy from low-velocity impacts, it's highly effective at restricting damage to one specific location. In particular, damage is reduced the most when the impact occurs at right angles to the direction of the grain. Diagnostic research has shown that different types of wood exhibit different levels of resistance. One of the factors is density, since denser woods absorb more energy during impact. The number of vessels in the wood, their size and distribution, are also important factors in reducing impact deformation.<sup>29</sup>

**Right: Wood consists of tube-like fibers which give wood its resistant properties.**

**Below right: Wood's raw material, known as cellulose, possesses a complicated chemical structure. If the chemical bonds or atoms comprising cellulose were different, then wood wouldn't be so strong and flexible.**

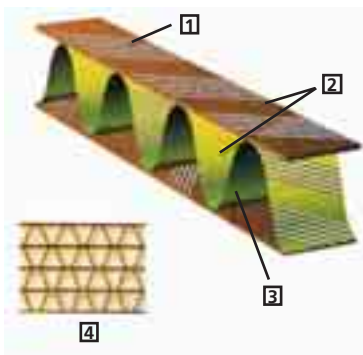
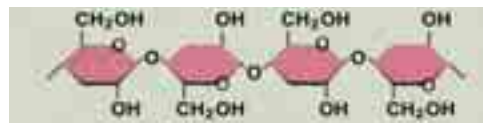
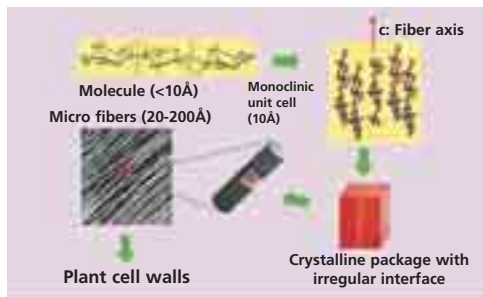

**Left: A structure modeled on wood for the making of bullet-proof clothing. If wood had a different structure, it could not possess such resilient hardness.**

- 1. Carefully placed fibers to imitate the spiral winding of the tube walls in wood.**
- 2. Resin reinforced with glass fibers.**
- 3. Corrugated layer between flat plates.**
- 4. Layers arranged to imitate the tube structure of wood.**



**These materials, modeled on the structure of wood, are believed to be sufficiently strong to be used in bullet-proof vests. (Julian Vincent, "Tricks of Nature," *New Scientist*, 40.)**

The Second World War's Mosquito aircraft, which so far have shown the greatest tolerance to damage, were made by gluing dense plywood layers between lighter strips of balsa wood. The hardness of wood makes it a most reliable material. When it does break, the cracking takes place so slowly that one can watch it happen with the naked eye, thus giving time to take precautions.<sup>30</sup>

Wood consists of parallel columns of long, hollow cells placed end to end, and surrounded by spirals of cellulose fibers. Moreover, these cells are enclosed in a complex polymer structure made of resin. Wound in a spiral, these layers form 80% of the total thickness of the cell wall and, together, bear the main weight. When a wood cell collapses in on itself, it absorbs the energy of impact by breaking away from the surrounding cells. Even if the crack runs between the fibers, still the wood is not deformed. Broken wood is nevertheless strong enough to support a significant load.

Material made by imitating wood's design is 50 times more durable than other synthetic materials in use today.<sup>31</sup> Wood is currently imitated in materials being developed for protection against high-velocity particles, such as shrapnel from bombs or bullets.

As these few examples show, natural substances possess a most intelligent design. The structures and resistance of mother-of-pearl and wood are no coincidence. There is evident, conscious design in these ma-



terials. Every detail of their flawless design—from the fineness of the layers to their density and the number of vessels—has been carefully planned and created to bring about resistance. In one verse, God reveals that He has created everything around us:

**What is in the heavens and in the earth belongs to God. God encompasses all things. (Qur'an, 4: 126)**

### **Spider Silk Is Stronger Than Steel**

A great many insects—moths and butterflies, for example—produce silk, although there are considerable differences between these substances and spider silk.

According to scientists, spider thread is one of the strongest materials known. If we set down all of a spider web's characteristics, the resulting list will be a very long one. Yet even just a few examples of the properties of spider silk are enough to make the point:<sup>32</sup>

- The silk thread spun by spiders, measuring just one-thousandth of a millimeter across, is five times stronger than steel of the same thickness.



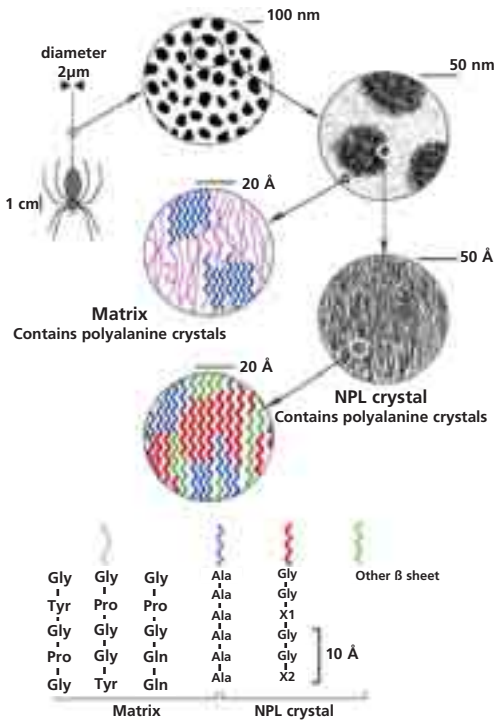

Spider silk, possessing an exceedingly complex structure, is but one example of God's incomparable art and infinite wisdom.

- It can stretch up to four times its own length.
- It is also so light that enough thread to stretch clear around the planet would weigh only 320 grams.

These individual characteristics may be found in various other materials, but it is a most exceptional situation for them all to come together at once. It's not easy to find a material that's both strong and elastic. Strong steel cable, for instance, is not as elastic as rubber and can deform over time. And while rubber cables don't easily deform, they aren't strong enough to bear heavy loads.

How can the thread spun by such a tiny creature have properties vastly superior to rubber and steel, product of centuries of accumulated human knowledge?

Spider silk's superiority is hidden in its chemical structure. Its raw material is a protein called keratin, which consists of helical chains of amino acids cross-linked to one another. Keratin is the building block for such widely different natural substances as hair, nails, feathers and skin. In all the substances it comprises, its protective property is especially important. Furthermore, that keratin consists of amino acids bound by loose hydrogen links makes it very elastic, as described in the American maga-



*zine Science News: "On the human scale, a web resembling a fishing net could catch a passenger plane."<sup>33</sup>*

On the underside of the tip of the spider's abdomen are three pairs of spinnerets. Each of these spinnerets is studded with many hairlike tubes called spigots. The spigots lead to silk glands inside the abdomen, each of which produces a different type of silk. As a result of the harmony between them, a variety of silk threads are produced. Inside the spider's body, pumps, valves and pressure systems with exceptionally developed properties are employed during the production of the raw silk, which is then drawn out through the spigots.<sup>34</sup>

Most importantly, the spider can alter the pressure in the spigots at will, which also changes the structure of molecules making up the liquid keratin. The valves' control mechanism, the diameter, resistance and elasticity of the thread can all be altered, thus making the thread assume desired characteristics without altering its chemical structure. If deeper changes in the silk are desired, then another gland must be brought into operation. And finally, thanks to the perfect use of its back legs, the spider can put the thread on the desired track.

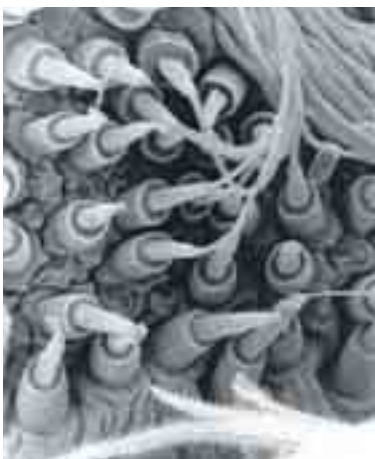

A detailed view of the spigots.

Once the spider's chemical miracle can be replicated fully, then a great many useful materials can be produced: safety belts with the requisite elasticity, very strong surgical sutures that leave no scars, and bulletproof fabrics. Moreover, no harmful or poisonous substances need to be used in their production.

Spiders' silk possesses the most extraordinary properties. On account of its high resistance to tension, ten times more energy is required to break spider silk than other, similar biological materials.<sup>35</sup>

As a result, much more energy needs to be expended in order to break a piece of spider silk of the same size as a nylon thread. One main reason why spiders are able to produce such strong silk is that they manage to add assisting compounds with a regular structure by controlling the crystallization and folding of the basic protein compounds. Since the weaving material consists of liquid crystal, spiders expend a minimum of energy while doing this.

The thread produced by spiders is much stronger than the known natural or synthetic fibers. But the thread they produce cannot be collected and used directly, as can the silks of many other insects. For that reason, the only current alternative is artificial production.

Researchers are engaged in wide-ranging studies on how spiders produce their silk. Dr. Fritz Vollrath, a zoologist at the university of Aarhus in Denmark, studied the garden spider *Araneus diadematus* and succeeded in uncovering a large part of the process. He found that spiders harden their silk by acidifying it. In particular, he examined the duct through which the silk passes before exiting the spider's body. Before en-

tering the duct, the silk consists of liquid proteins. In the duct, specialized cells apparently draw water away from the silk proteins. Hydrogen atoms taken from the water are pumped into another part of the duct, creating an acid bath. As the silk proteins make contact with the acid, they fold and form bridges with one another, hardening the silk, which is *"stronger and more elastic than Kevlar [ . . . ] the strongest man-made fiber,"* as Vollrath puts it.<sup>36</sup>

Kevlar, a reinforcing material used in bulletproof vests and tires, and made through advanced technology, is the strongest manmade synthetic. Yet spider thread possesses properties that are far superior to Kevlar. As well as its being very strong, spider silk can also be re-processed and re-used by the spider who spun it.

If scientists manage to replicate the internal processes taking place

**To catch their prey, spiders construct exceedingly high-quality webs that stop a fly moving through the air by absorbing its energy. The taut cable used on aircraft carriers to halt jets when they land resembles the system that spiders employ. Operating in exactly the same way as the spider's web, these cables halt a jet weighing several tons, moving at 250 kmph, by absorbing its kinetic energy.**





This example alone is enough to demonstrate the great wisdom of God, the Creator all things in nature: Spiders produce a thread five times stronger than steel. Kevlar, the product of our most advanced technology, is made at high temperatures, using petroleum-derived materials and sulfuric acid. The energy this process requires is very high, and its byproducts are exceedingly toxic. Yet from the point of view of strength, Kevlar is much weaker than spider silk. (“Biomimicry,” *Your Planet Earth*; <http://www.yourplanetearth.org/terms/details.php3?term=Biomimicry>)

inside the spider—if protein folding can be made flawless and the weaving material's genetic information added, then it will be possible to industrially produce silk-based threads with a great many special properties. It is therefore thought that if the spider thread weaving process can be understood, the level of success in the manufacture of man-made materials will be improved.

This thread, which scientists are only now joining forces to investigate, has been produced flawlessly by spiders for at least 380 million years.<sup>37</sup> This, no doubt, is one of the proofs of God's perfect creation. Neither is there any doubt that all of these extraordinary phenomena are under His control, taking place by His will. As one verse states, “**There is no creature He does not hold by the forelock**” (Qur'an, 11: 56).

Harun Yahya

## The Mechanism for Producing Spider Thread Is Superior to Any Textile Machine

Spiders produce silks with different characteristics for different purposes. *Diatematus*, for instance, can use its silk glands to produce seven different types of silk—similar to production techniques employed in modern textile machines. Yet those machines' enormous size can't be compared with the spider's few cubic millimeters silk-producing organ. Another superior feature of its silk is the way that the spider can recycle it, able to produce new thread by consuming its damaged web.



Chapter 2.

# THE DESIGN IN PLANTS AND BIOMIMETICS

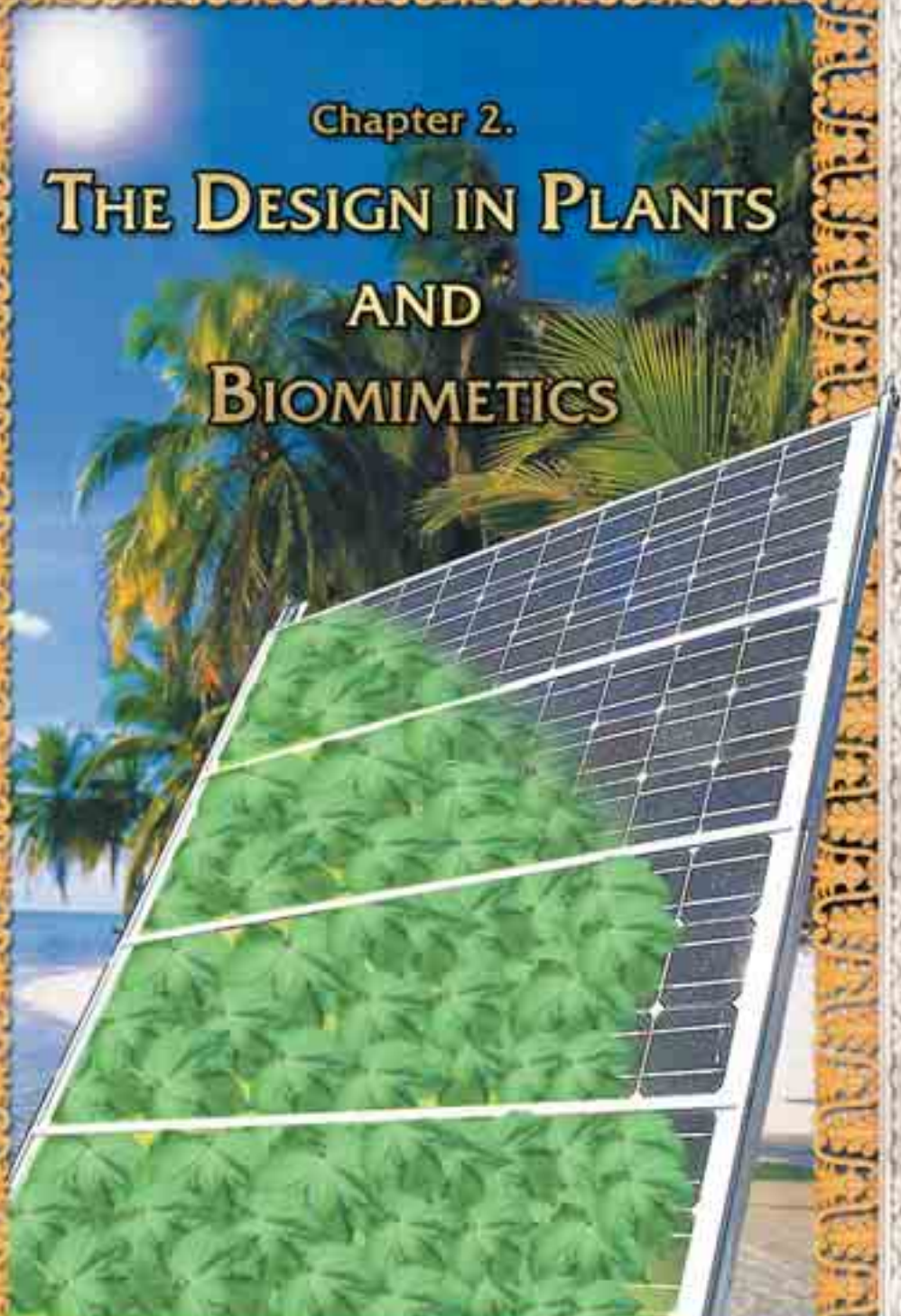



*F*

iber-optic technology, which has recently begun to be employed, uses cables capable of transmitting light and high-capacity information. What if someone were to tell you that living things have been using this technology for millions of years? These are organisms you know very well, but whose superior design a great many people never even consider—plants.

Because so many look at their world around them in a superficial way, out of familiarity, they never see the examples of superior design in the living things that God has created. But in fact, all living things are full of secrets. Asking why and how is enough to let you raise this curtain of familiarity. Anyone who thinks about these questions will realize that everything we see around us is the work of a Creator possessed of reason and knowledge—our

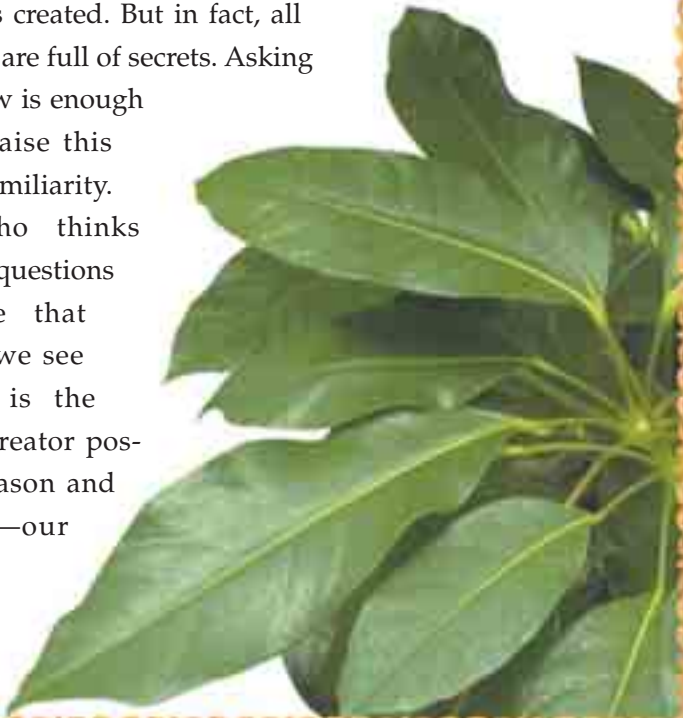

All-Powerful Lord. As an example, take the photosynthesis that plants carry out—a miracle of creation, whose mysteries have not yet been uncovered.

Photosynthesis is the process whereby green plants turn light into carbohydrates that human beings and animals can consume. Perhaps at first sight, this description might not seem too remarkable, yet biochemists believe that artificial photosynthesis could easily change the whole world.

Plants carry out photosynthesis by means of a complex string of events. The exact nature of these processes is still unclear. Just this feature alone is enough to silence the proponents of the theory of evolution. Professor Ali Demirsoy describes very well the dilemma that photosynthesis represents for evolutionist scientists:

*Photosynthesis is a rather complicated event and appears impossible to emerge in the organelles within the cell. That is because it is impossible for all the stages to come about at once, and meaningless for them to do so separately.<sup>38</sup>*

Plants trap sunlight in natural solar cell parts known as chloroplasts. In the same way, we store in batteries the energy we obtain from artificial solar panels, which turn light into electrical energy.

A plant cell's low power output necessitates the use of a great many "panels," in the form of leaves. It's enough for leaves, like solar panels, to face the sun in order to meet human beings' energy needs. When the chloroplasts' functions are fully replicated, tiny solar batteries will be able to operate equipment requiring a great deal of energy. Spacecraft and artificial satellites will be able to operate using solar energy alone, with no need for any other energy source.

Plants, which possess such superior capabilities and astound the scientists who try to imitate them, bow their heads to God, like all other living things. This is revealed in a verse:

**Shrubs and trees both bend in worship. (Qur'an, 55: 6)**

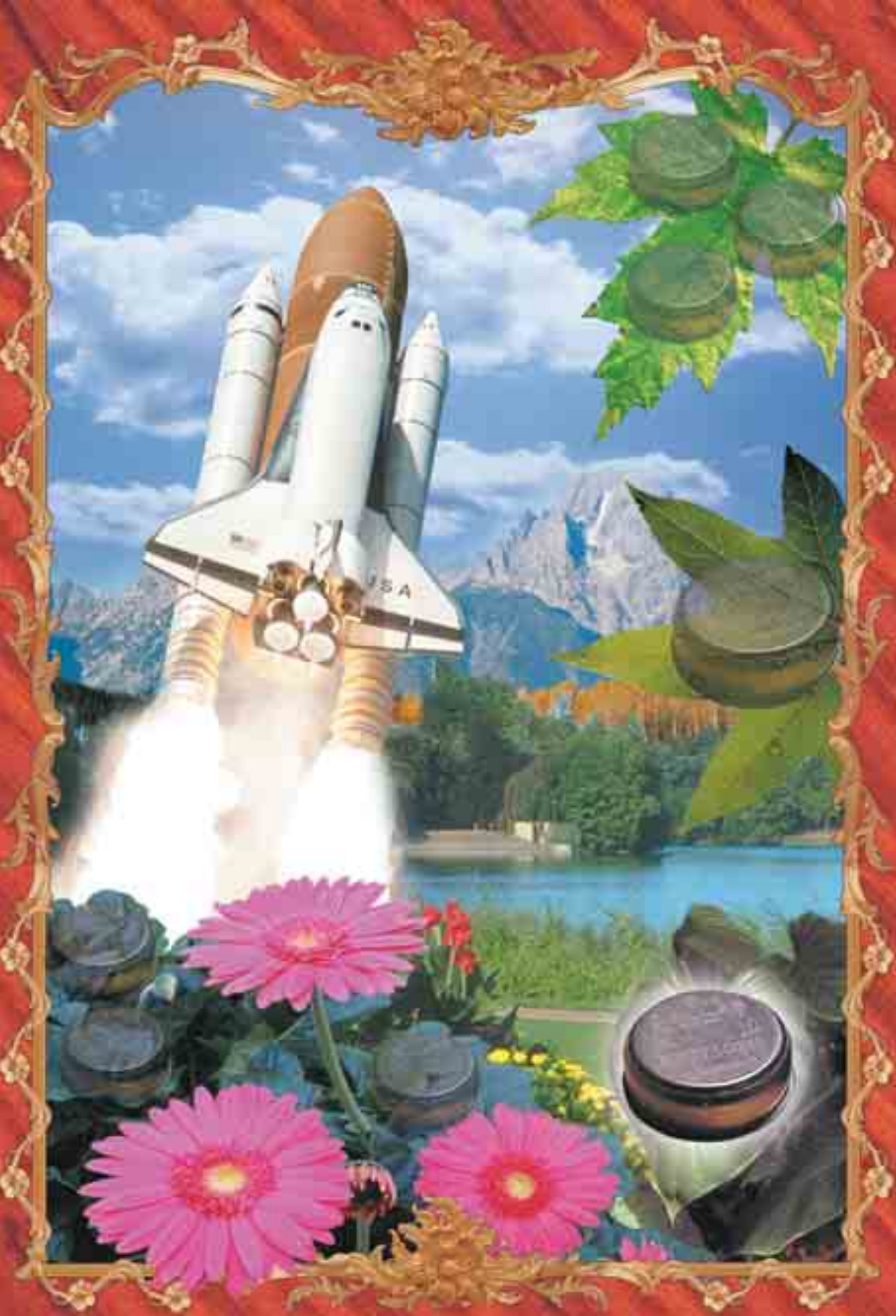

Biomimetics: Technology Imitates Nature



What mankind has to learn from plants isn't limited to solar cells. Plants are opening up many new horizons, from construction to the perfume industry. Chemical engineers producing deodorants and soaps are now trying to produce beautiful fragrances in the laboratory by imitating the scents of flowers. The scents produced by many famous houses, such as Christian Dior, Jacques Fath, Pierre Balmain, contain floral essences found in nature. ("The History of Perfume;" <http://www.parfumsraffy.com/history.html>)

### **Protected Surfaces**

Any surface can be damaged by dirt, or even by bright light. That is why scientists have developed furniture and car polishes, and liquids to

block ultraviolet rays and protect against any possible wear and tear. In nature also, animals and plants produce in their own cells a variety of substances to protect their outer surfaces against external damage. The complex chemical compounds produced by the bodies of living things astound scientists, and designers seek to imitate many examples.

Coating wooden surfaces is important to protect them from dirt and wear and tear, particularly against water, which can enter and rot soft tim-

**The external surfaces of leaves are covered with a thin, polished coating that waterproofs the plant. This protection is essential because carbon dioxide, which plants absorb from the air and is essential to their survival, is found between the leaf cells. If these spaces between the cells filled with rainwater, the carbon dioxide level would fall and the process of photosynthesis, essential to plants' survival, would slow down. But thanks to this thin coating on their leaves' surface, plants are able to carry on photosynthesis with no difficulty.**



ber. But did you know that the first wood coatings were made from natural oils and insect secretions?

Many protective substances used in our daily lives were actually used long before in nature by living things. Wood polish is just one example. The hard shells of insects also protect them against water and damage from the outside.

Insects' shells and exoskeletons are reinforced by a protein called sclerotin, making them among the hardest surfaces in the natural world.

Furthermore, an insect's protective chitin covering never loses its color and brightness.<sup>39</sup>

Clearly, considering all this, the systems construction firms use to cover and protect external surfaces will be much more effective if they have a composition similar to those found in insects.



## The Constantly Self-Cleaning Lotus

The lotus plant (a white water lily) grows in the dirty, muddy bottom of lakes and ponds, yet despite this, its leaves are always clean. That is because whenever the smallest particle of dust lands on the plant, it immediately waves the leaf, directing the dust particles to one particular spot. Raindrops falling on the leaves are sent to that same place, to thus wash the dirt away.

This property of the lotus led researchers to design a new house paint. Researchers began working on how to develop paints that wash clean in the rain, in much the same way as lotus leaves do. As a result of this investigation, a German company called ISPO produced a house paint brand-named Lotusan. On the market in Europe and Asia, the product even came with a guarantee that it would stay clean for five years without detergents or sandblasting.<sup>40</sup>

Of necessity, many living things possess natural features that protect their external surfaces. There is no doubt, however, that neither the lotus's external structure nor insects' chitin layer came about by themselves. These living things are unaware of the superior properties they possess. It is God Who creates them, together with all their features. One verse describes God's art of creation in these terms:

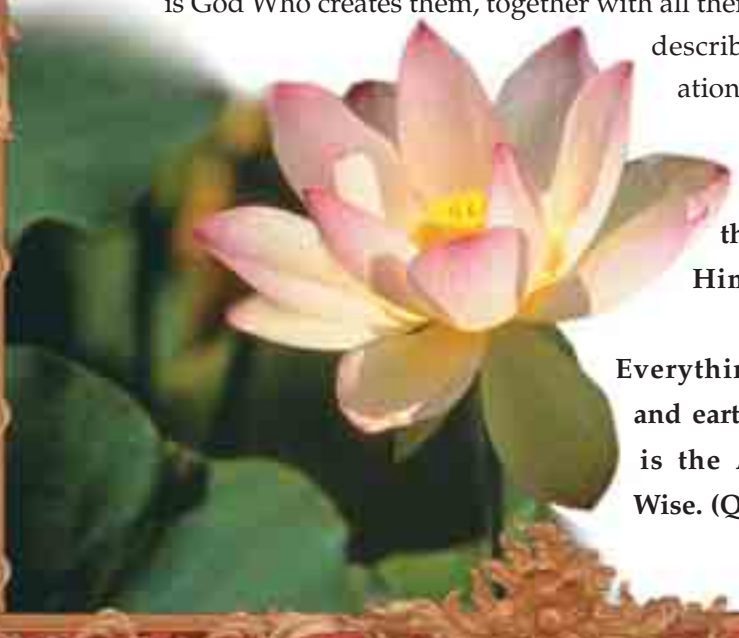

**He is God—the  
Creator, the Maker,  
the Giver of Form. To  
Him belong the Most  
Beautiful Names.  
Everything in the heavens  
and earth glorifies Him. He  
is the Almighty, the All-  
Wise. (Qur'an, 59: 24)**



A lotus leaf with water on it



During his microscopic research, Dr. Wilhelm Barthlott at the University of Bonn realized that leaves that required the least cleaning were those with the roughest surfaces. On the surface of the lotus leaf, the very cleanest of these, Dr. Barthlott found tiny points, like a bed of nails. When a speck of dust or dirt falls onto the leaf, it teeters precariously on these points. When a droplet of water rolls across these tiny points, it picks up the speck, which is only poorly attached, and carries it away. In other words, the lotus has a self-cleaning leaf. This feature has inspired researchers to produce a house paint called LOTUSAN, guaranteed to stay clean for five years. (Jim Robbins, "Engineers Ask Nature for Design Advice," *New York Times*, December 11, 2001.)



How a raindrop cleans a lotus leaf



The effect of a raindrop on a normal surface



The effect of raindrops on a building exterior covered with Lotusan.



## Plants and New Car Design

When designing its new ZIC (Zero Impact Car) model, the Fiat motor company copied the way trees and shrubs divide themselves into branches. Designers built a small channel along the middle of the car, in a similar way as in a plant's stem, and placed in that channel batteries to provide the car with the energy it requires. The car seats were inspired by the plant in the illustration and, just as in that original plant, the seats were attached directly to the channel. The car's roof featured a honeycomb structure similar to that in seaweed. This structure made the ZIC both light and strong.<sup>41</sup>

In a field like automobile technology that freely displays the very latest innovations, a simple plant, living in nature since the very first day it came into being thousands of years ago, provided engineers and designers with a source of inspiration. Evolutionists—who maintain that life came about by chance and whose forms developed over time, always moving in the direction of improvement—find this and similar events difficult to accept.

How can human beings, possessed of consciousness and reason, learn from plants—devoid of any intelligence or knowledge, which cannot even move—and implement what they learn to achieve ever more practical results? The features that



Seaweed

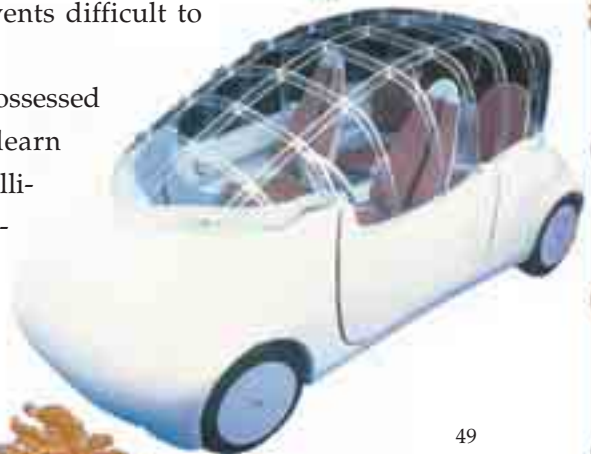

plants and other organisms display cannot, of course, be explained away as coincidences. As proofs of creation, they represent a serious quandary for evolutionists.

### **Plants that Give Off Alarm Signals**

Nearly everyone imagines that plants are unable to combat danger, which is why they easily become fodder for insects, herbivores, and other animals. Yet research has shown that on the contrary, plants use amazing tactics to repel, even overcome their enemies.

To keep leaf-chewing insects at bay, for example, plants sometimes produce noxious chemicals and in a few cases, chemicals to attract other predators to prey on those first ones. Both tactics are no doubt very clever. In the field of agriculture, in fact, efforts are going on to imitate this very useful defense strategy. Jonathan Gershenzon, researching the genetics of plant defenses at Germany's Max Planck Institute for Chemical Ecology, believes that if this intelligent strategy can be imitated properly, then in the future, non-toxic forms of agricultural pest control could be provided.<sup>42</sup>

When attacked by pests, some plants release volatile organic chemicals that attract predators and parasitoids, which lay their eggs inside the living body of pests. The larvae which hatch out inside the pest grow by feeding on the pest from within. This indirect strategy thus eliminates harmful organisms that might damage the crop.

Again, it is by chemical means that the plant realizes that a pest is eating its leaves. The plant gives off such an alarm signal not because it "knows" it's losing its leaves, but rather as a response to chemicals in the pest species' saliva. Although superficially, this phenomenon appears to be quite simple, actually quite a number of points need to be considered:

- 1) How does the plant perceive chemicals in the pest's saliva?

Harun Yahya



The manduca moth and  
the tobacco plant

2) How does the plant know that it will be freed from the pest's ravages when it gives off the alarm signal?

3) How does it know that the signal it gives off will attract predators?

4) What causes the plant to send its signal to insects that feed on its assailants?

5) That signal the plant gives off is chemical, rather than auditory. The chemicals employed by insects have a most complex structure. The slightest deficiency or error in the formula, and the signal may lose its efficacy. How is the plant thus able to fine-tune this chemical signal?

No doubt it is impossible for a plant, lacking a brain, to arrive at a solution to danger, to analyze chemicals like a scientist, even to produce such a compound and carry out a planned strategy. Very definitely, indirectly overcoming an enemy is the work of a superior intelligence. That intelligence's possessor is God, Creator of the plants with all their flawless characteristics and Who inspires them to do what they can to protect themselves.



**Geocoris**

Therefore, current biomimetic research is making a great effort to imitate the astonishing intelligence that God displays in all living things.

One group of researchers, from both the International Centre of Insect Physiology and Ecology in Nairobi, Kenya and Britain's Institute of Arable Crops Research, carried out a study on this



**Manduca moth caterpillar**

subject. To remove pests among maize and sorghum, their team planted species that the stem-borers like to eat, pulling the

pests from the crop. Among the crops, they grew species that repel stem-borers and attract parasitoids. In such fields, they found, the number of plants infested with stem-borers dropped by more than 80%. Further applications of this incomparable solution observed in plants will make for still further advances.<sup>43</sup>

Wild tobacco plants in Utah are subject to attack by caterpillars of the moth *Manduca quinquemaculata*, the eggs of which are a favorite food of the bug *Geocoris pallens*. Thanks to volatile chemicals that the tobacco plant releases, the *G. pallens* is attracted, and number of *M. quinquemaculata* caterpillars is reduced.<sup>44</sup>

### **Fiber Optic Design in the Ocean Depths**

*Rossella racovitzae*, a species of marine sponge, possesses spicules guiding light as optic fibers do, which of course is employed in the very latest technology. The optical fibers can instantly transport vast amounts of information encoded as light pulses across tremendous distances. Transmitting laser light down a fiber-optic cable makes possible communications unimaginably greater than with cables made of ordinary materials. In fact, a strand no thicker than a hair, containing 100 optical fibers, can transmit 40,000 different sound channels.

This species of sponge which lives in the cold, dark depths of Antarctic seas is easily able to collect the light it requires for photosynthesis thanks to its thorn-shaped protrusions of optical fibers, and is a source of light for its surroundings. This enables both the sponge itself and other living things that benefit from its ability to collect and transmit light to survive. Single-celled algae attach themselves to the sponge and obtain from it the light they need to survive.

Fiber optics is one of the most advanced technologies of recent years. Japanese engineers use this technology to transmit solar rays to those

parts of skyscrapers that receive no direct light. Giant lenses sited in a skyscraper's roof focus the sun's rays on the ends of fiber optic transmitters, which then send light to even the very darkest parts of the buildings.

This sponge lives at some 100 to 200 meters depth, off the shores of the Antarctic Ocean, under icebergs in what is virtually total darkness. Sunlight is of the greatest importance to its survival. The creature manages to solve this problem by means of optical fibers that collect solar light in a most effective manner.

Scientists are amazed that a living thing should have used the fiber optic principle, utilized by high-tech industries, in such an environment for the past 600 million years. Ann M. Mescher, a mechanical engineer and polymer fiber specialist at the University of Washington, expresses it in these terms:

*It's fascinating that there's a creature that produces these fibers at low temperature with these unique mechanical properties and fairly good optical properties.<sup>45</sup>*

Brian D. Flinn, University of Washington materials scientist, describes the superior structure in this sponge:

*It's not something they're going to put into telecommunications in the next two or three years. It's something that might be 20 years off.<sup>46</sup>*

This all demonstrates that the living things within nature harbor a great many models for human beings. God, Who has designed everything down to the finest detail, has created these designs for mankind to learn from and think upon. This is revealed in the verses:

**In the creation of the heavens and the Earth, and the alternation of night and day, there are signs for people with intelligence: those who remember God, standing, sitting and lying on their sides, and reflect on the creation of the heavens and the Earth: "Our Lord, You have not created this for nothing. Glory be to You! So safeguard us from the punishment of the Fire." (Qur'an, 3: 190-191)**

"The Originator of the heavens and earth. When He decides on something, He just says to it, 'Be!' and it is."  
(Qur'an, 2: 117)



*Rossella racovitzae*



Optical fibers

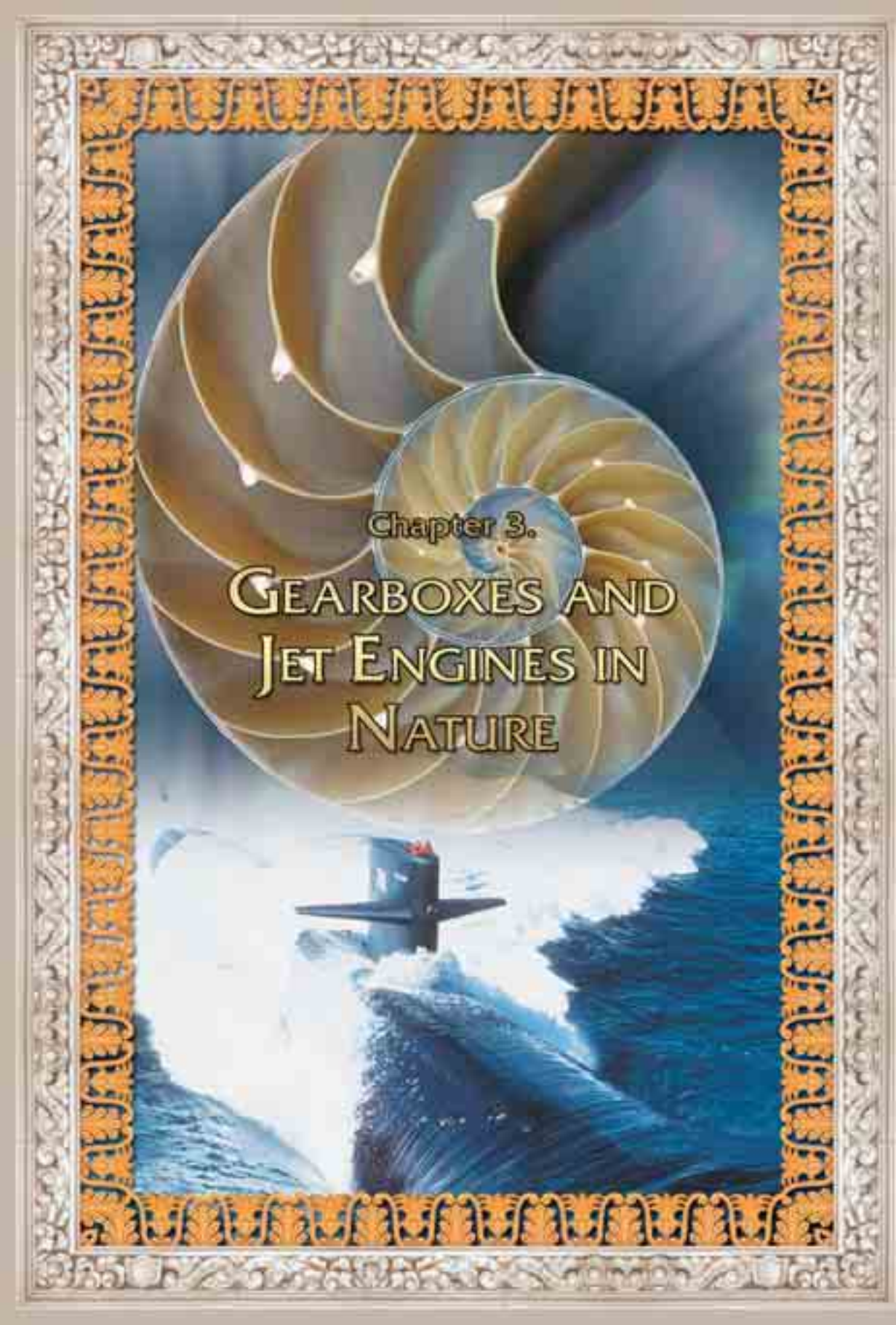

Chapter 3.  
GEARBOXES AND  
JET ENGINES IN  
NATURE





ust about everyone interested in motor vehicles knows the importance of gearboxes and jet engines. Few, however, are aware that there are gearboxes and jet engines in nature, which possess designs far superior to those employed by man.

Gearboxes allow you to change gears in the vehicle so that the motor is used most efficiently. Natural gearboxes work along the same principles as those in cars. Flies, for example, use a natural gearbox that provides three-speed gearshift connected to its wings. Thanks to this system, a fly can instantaneously accelerate or slow down by flapping its wings at the desired speed while in the air.<sup>47</sup>

In cars, at least four gears are used to transmit the power from the engine to the wheels. It is possible to drive smoothly only when the gears are used in succession, from low gear to high, and back again. Instead of gears in cars, which are

heavy and take up a lot of room, flies have a mechanism that takes up only a few cubic millimeters. Thanks to their far more functional mechanism, flies can beat their wings with ease.

The squid, octopus and nautilus employ a propellant force similar to the principle used by jet engines. To understand just how effective

this force is, consider that the species of squid known as *Loligo vulgaris* can travel in the water at speeds up to 32 kilometers [20

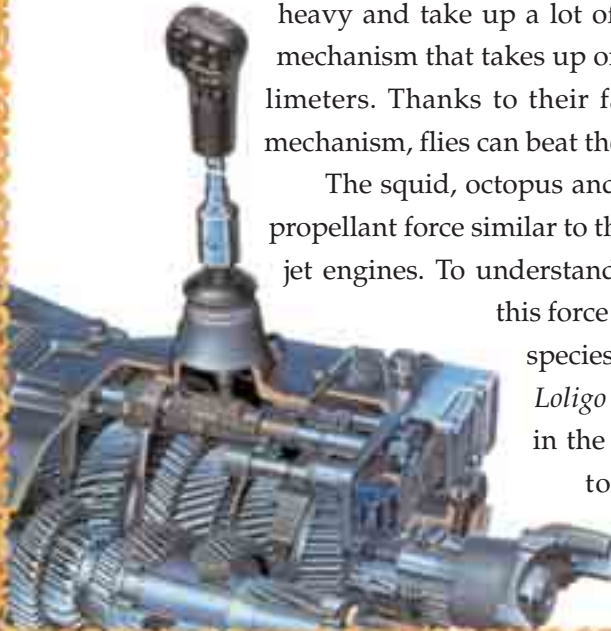

A jet engine takes in air from one end and expels it from the other at a much greater speed. The jet engines in vertical take-off aircraft like the Harrier have nozzles to direct the exhaust down. Thanks to this system, the Harrier can land and take off vertically. After take-off, the nozzles are pointed backwards, so that the aircraft flies forwards.



The squid use a form of propulsion system similar to jet planes. A squid's body contains two open spaces like pockets. Water taken in from them is drawn into a powerful elastic bag of contracting muscles. In this bag is a backward-pointing nozzle. The muscles contract, expelling water out of that nozzle at high speed. The animal can reach speeds of up to 32 km (20 miles) an hour to flee predators, sometimes even leaping out of the water and onto the decks of ships. (Phil Gates, *Wild Technology*, 38.)

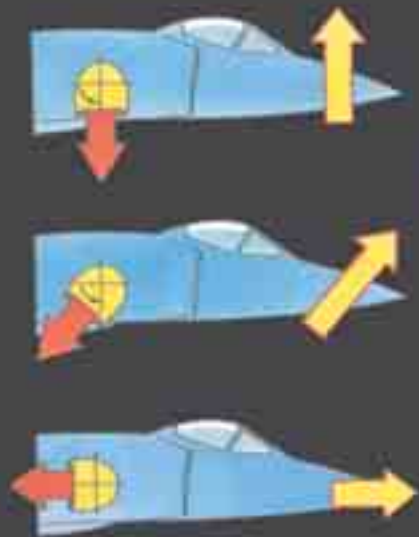



When threatened by a starfish, the scallop suddenly closes the two halves of its shell. It thus expels a quantity of water in such a way as to set up jet propulsion and forces itself forward.

miles] an hour.<sup>48</sup>

The nautilus, an incomparable example in this regard, resembles an octopus and may be compared to a ship with a jet engine. It takes water in through a tube beneath its head and then shoots the water out. While the water travels in one direction, the nautilus is propelled in the other.



Known by its scientific name of *Ecballium elaterium*, the squirting cucumber disperses its fruit's seeds in a sudden explosion. As the fruit ripens, it fills with a slimy juice, which gradually creates pressure. Through the buildup of internal pressure, it then propels its seeds with an initial velocity of 56 km (35 miles) per hour. (Helmut Tributsch, *How Life Learned to Live*, Cambridge: MIT Press, 1982, 59.)

## 100-Million-Year-Old Technology Under the Sea

When a submarine fills its ballast tanks with water, the ship becomes heavier than water and sinks toward the bottom. If water in the tanks is emptied out by means of compressed air, then the submarine surfaces. The nautilus employs the same technique. In its body there is a 19-cm (7.48 in) spiral organ rather like a snail's shell, inside which are 38 interconnected "diving" chambers. To empty out the water; it also needs compressed air—but where does the nautilus find the air it needs?

By biochemical means, the nautilus produces a special gas in its body and transfers this gas to the chambers, expelling water from them to regulate its buoyancy. This allows the nautilus to dive or surface when hunting or chased by predators.

A submarine can only venture safely to a depth of about 400 meters (1,310 feet), whereas the nautilus can easily descend to a depth of 450 meters (1,500 feet).<sup>49</sup>



Nautilus





Submarines' diving techniques resemble those of fish, which are able to control their relative density in order to rise or dive in the water. In their bodies, bony fish have a swim bladder that gives them their buoyancy. When air is added to the swim bladder, by diffusion through the blood vessels in the bladder walls, the fish becomes less dense overall; when air is removed the fish becomes more dense. By changing the volume of air in the bladder, the fish's density can be made equal to that of the surrounding water at a given depth.

Such a depth is very dangerous to many living things. But despite this, the nautilus remains unaffected, its shell is not crushed by the pressure and its body suffers no harm.

Another very important point needs to be considered here. The nautilus has possessed this system, which can withstand the pressure at some 450 meters, since the day it was created. How can it have designed this special structure all by itself? On its own, could the nautilus have developed the gas to obtain the necessary compressed air to empty out the water in its shell? It is definitely impossible for the creature to know how to create the chemical reaction to produce gas, much less build the structures in its body necessary to bring that chemical reaction about, nor to structure a shell capable of withstanding tons of water pressure.

This superior design is the work of God, Who flawlessly created everything, with no prior models. God's title of al-Badi' (the Innovative Creator), is revealed in the Qur'an:

**He is the Originator of the heavens and the Earth... (Qur'an, 6: 101)**



The depth of a submarine in water is adjusted by special command systems, the product of human intelligence, after many years of engineering research. No rational person can claim that these devices came about by chance.

Evolutionists, however, make the unrealistic claim that although the nautilus can do exactly what a submarine does, it is actually the product of blind chance.

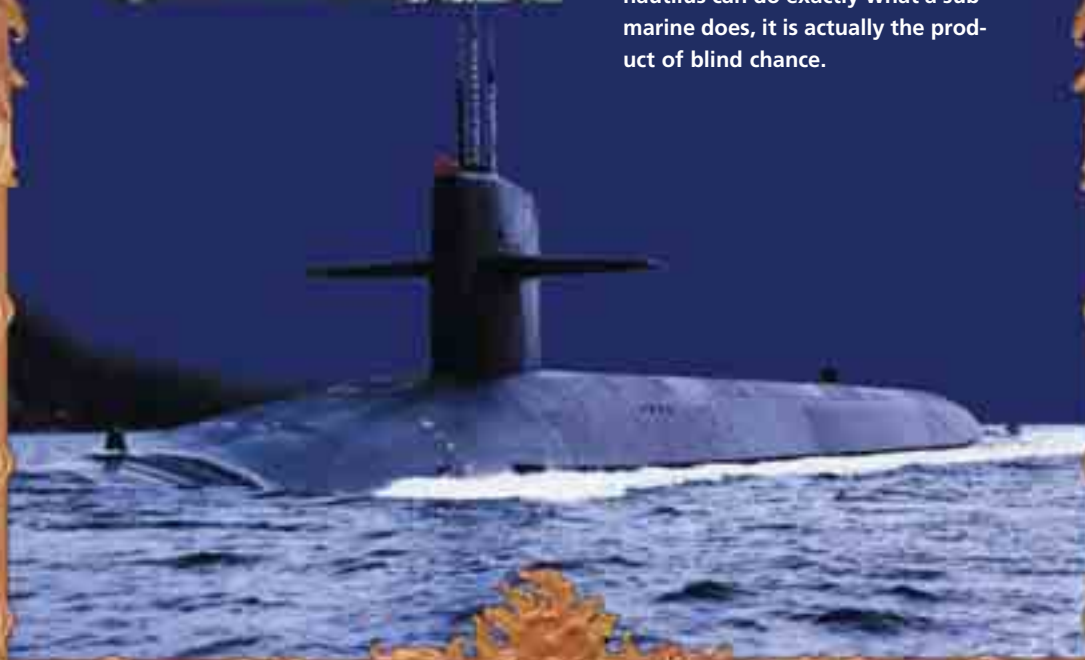

This 100-million-year-old nautilus fossil is proof that the animal never underwent evolution. God created the creature in an instant, and with all its flawless design.





Chapter 4.

# USING WAVES AND VIBRATIONS

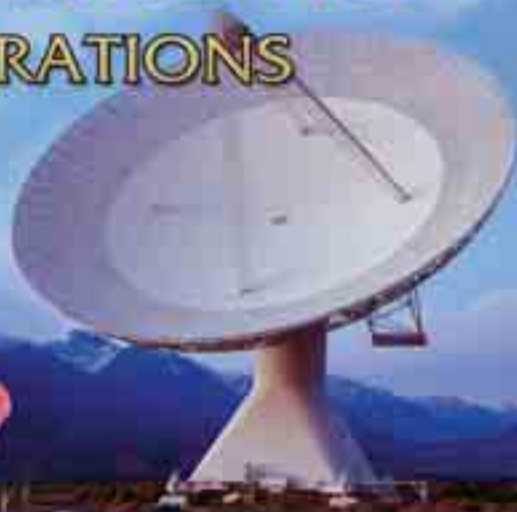





ound moves through air and water in the form of waves, which bounce back if they strike an object. If you possess the necessary technology and knowledge, these rebounding waves can provide a great deal of information about the body they encountered, such as its distance from the source, its size, and the direction and speed of its motion.

This technology to locate objects by means of sound and pressure waves was developed in the 20<sup>th</sup> century, actually for military purposes. But today, it is also used to locate sunken ships and for mapping the ocean floor. However, millions of years ago, long before man discovered this technology, living things in nature were using the sound waves they spread around them in order to survive.

Dolphins, bats, fish and moths have all possessed this system, known as sonar, ever since they were created. What is more, their systems are much more sensitive and functional than those employed by human beings today.

### **Bats' Sonar Goes Far Beyond the Bounds of Human Technology**

The U.S. Defense Department set out to implement principles of bat sonar in its own system of sonar, an indispensable method for locating submarines under the surface of the sea. According to a report in *Science*, one of America's best-known magazines, the Defense Department set aside a special allocation to pay for this project.

It has long been known that bats use their sonar system to find their way around in the pitch dark. Recently, researchers have uncovered new secrets of how they do it. According to their research, the brown insectivorous bat, *Eptesicus fuscus*, can process two million overlapping echoes a second. Furthermore, it can perceive these echoes with a resolution of only 0.3 millimeters (1/80<sup>th</sup> of an inch). According to these figures, bat's sonar is three times more sensitive than its man-made equivalent.<sup>50</sup>

Bats' sonar navigational skills teach us a great deal about flying in the dark. Research carried out with infrared thermal imaging cameras and ultrasound detectors afforded considerable information about how bats fly in search of prey at night.

Bats can seize an insect from mid-air as the insect rises from the grass. Some bats even plunge into bushes to capture their prey. It's no easy task to seize an insect buzzing in the air using only reflected sound waves. But if you consider that the insect is among the bushes, and sound waves bounce back from all the leaves surrounding it, you will grasp what an impressive task the bat actually performs.

In a situation like that, bats reduce their sonar squeals, to prevent their becoming confused by echoes from the surrounding vegetation. Yet by itself, this tactic isn't enough to enable bats to perceive the objects individually, because they also need to distinguish the arrival time and direction of the overlapping echoes.<sup>51</sup>

Bats also use their sonar when flying over water to drink, and in some cases, to capture prey from the ground. Their expert maneuverability can best be seen when one bat chases another. Understanding how they can do this will let us produce a wide range of technological products, especially equipment for sonar navigation and detection. Moreover, bats' broad-band sonar system is also imitated today in mine-sweeping technology.<sup>52</sup>

As we have seen, the properties of living things benefit us in a very large number of ways. In one verse, God draws attention to the uses in animals:

**And there is certainly a lesson for you in your livestock. We give you to drink from what is in their bellies and there are many ways in which you benefit from them... (Qur'an, 23: 21)**



With their highly developed radar equipment, the AWACS (*Airborne Warning And Control System*) in Boeing 767 jets is used for early warning and target control purposes. AWACS, effective in the air and on land, can identify ships on the surface only and fails when it comes to submarines under the water (which are invisible to AWACS). (Bezen Çetin, "Hava Savunma Sistemleri," (Air Defense Systems) *Bilim ve Teknik*, Jan. 1995, 33.)



In identifying underwater targets, the Greater Bulldog Bat (*Noctilio leporinus*) is far superior to AWACS. This bat's sonar system enables it to hunt fish. It's no exaggeration to think of the bat as a kind of advanced warplane with early warning capabilities. When it locates a fish near the surface of the water, it goes into a dive. On the large feet of the bat, which are ideally designed for seizing fish, there are super sharp, powerful claws. As it approaches its prey, the bat drops its feet below the water, where its thin claws meet no water resistance. These large, sharp and pointed claws give the bat a great advantage when it comes to gripping its prey. ("More about bat echolocation;" <http://www.szgdocent.org/resource/ff/f-bateco.htm>)

Some moth species are able to confuse the bats' detection system by means of the high-pitched squeaks they emit. If the bat can't locate the moth, it's unable to catch it. (Phil Gates, *Wild Technology*, 53.) The EA-6B Prowler aircraft currently used by the U.S. military imitate these moths' tactics. It monitors the electromagnetic spectrum and actively denies an adversary the use of radar and communications. ("EA-6B Prowler;" <http://www.globalsecurity.org/military/systems/aircraft/ea-6.htm>)



EA-6B Prowler



## Dolphin Sound Waves and Sonar Technology

From a special organ known as the melon in its head, a dolphin can sometimes produce as many as 1,200 clicks a second. Simply by moving its head, this creature is able to transmit the waves in the direction it wishes. When the sound waves strike an object, they are reflected and return to the dolphin. The echoes reflected from the object pass through the dolphin's lower jaw to the middle ear, and from there to the brain. Thanks to the enormous speed at which these data are interpreted, very accurate and sensitive information is obtained. The echoes let the dolphin determine the direction of movement, speed and size of the object that reflects them.<sup>53</sup>

The dolphin sonar is so sensitive that it can even identify one single fish from among an entire shoal.<sup>54</sup> It can also distinguish between two separate metal coins, three kilometers away in the pitch dark.<sup>55</sup>

In the present day, the instrument known as SONAR<sup>56</sup> is used to identify targets and their directions for ships and submarines. Sonar works on exactly the same principle as that employed by the dolphin.

At Yale University, a robot was developed to be used for exploring

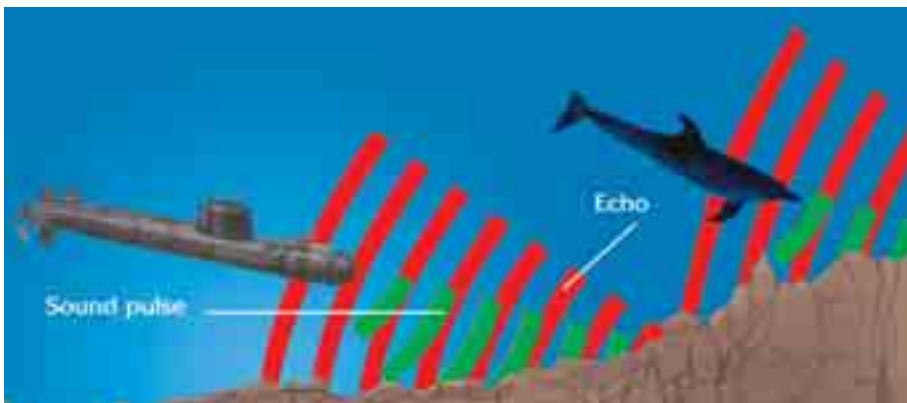

"Glory be to Him Who  
has the Dominion of  
all things in His Hand.  
To Him you will be  
returned."

(Qur'an, 36: 83)





Scientists and engineers have built several robots based on the sonar designs in nature. One of these, the robot named "koala," constructed by the K-Team Company, has six sonar units and was designed for remote-control exploration purposes.



Roman Kuc

new environments. An electrical engineering professor Roman Kuc equipped the robot with a sonar system imitating the one used by dolphins. Professor Kuc, who spent 10 years working on ultrasound sensors and robot-

ics research, admitted, *"We decided to take a closer look at how echolocation is used in nature to see if we might be missing something."*<sup>57</sup>

Imagine that someone told you that under the sea, sound waves travel at 1,500 meters a second; then asked you to calculate, if your submarine sent out sound waves that came back in four seconds' time, how far away was the object that reflected them.

You would calculate that you were three kilometers away. Dolphins are also capable of comfortably performing similar calculations, but they know neither the speed at which their sound waves travel through the water, nor how to multiply and divide. They don't carry out any of these functions; all the animals do is behave the way God inspires them.



Operators trained to interpret the data sit at the consoles of the most developed sonar systems. Yet dolphins, which evolutionists maintain are more primitive than man, have no need of such operators.

Evolutionists claim that dolphins' sonar emerged as the result of a series of changes caused by different factors. ("National Geographic TV's Undersea Fairy Tales;" [www.darwinism-watch.com/nat\\_geo\\_tv\\_undersea\\_tales.php](http://www.darwinism-watch.com/nat_geo_tv_undersea_tales.php)) This is as senseless and meaningless as claiming that wind or earth tremors brought together thousands of pieces of electrical equipment on a shelf and formed a sonar circuit.



Part of a sonar circuit





## Sonar Helps the Visually Impaired

As scientific research advances, we are discovering astonishing abilities in living things that offer solutions to problems in many areas of daily life, from the workplace to our hospitals. Darcy Winslow, General Manager of Environmental Business Opportunities for Nike, expresses this truth:

*The extent to which the natural world can provide technological solutions for the types of product performance characteristics we must provide are virtually unlimited. Biomimicry still requires exploration, innovation and creativity, but by thinking like or working with a biologist, we must learn to ask a different set of questions and look to nature for inspiration and learning opportunities.<sup>58</sup>*

Many firms are now following a strategy that parallels the one that Winslow set out. It is now possible to see electronic and mechanical engineers working together with biologists.

Already, engineers influenced by bat's sonar have mounted a small sonar unit onto a pair of glasses. After a period of familiarization with the glasses, visually handicapped people are now able to avoid obstacles and even ride bicycles. Still, the system's designers stress that it will never replace human vision eye or be as functional as that of the bat.

It's of course impossible for flawless features like this, which even experts have difficulties in replicating, to have appeared by chance. We must not forget that what we refer to here as "features" are actually complex, interconnected systems. The absence or breakdown of only one component means that the whole system fails to work. For example, if bats sent out sound waves but couldn't interpret the echoes reflected back, they would in fact have no echolocation system at all.

In scientific literature, the flawless and complete design that living things display is known as "irreducible complexity." In other words, certain designs become meaningless and functionless if reduced down to a simpler form. Irreducible complexity in all organisms and their systems

demolishes the fundamental idea of the theory of evolution, according to which organisms advance gradually, from the simple towards the complex. If a system can serve no purpose before it reaches its final form, there is no logical reason for it to maintain its existence over millions of years, while it refines and completes itself. A species can survive down the generations only if all its systems are present. No components of a system can afford the luxury of hoping to complete their alleged evolution over



time. This clearly proves that when living things first appeared on Earth, they were created with all their structures developed and fully formed, as they are today.

God brought animals and all other living things into being through His superior creation. News of this creation is given in a verse:

**And He created livestock. There is warmth for you in them, and various uses and some you eat. (Qur'an, 16: 5)**

## **The Superior Design in the Bat Is Showing Us to Make Our Roads Safer**

Researchers at the University of Edinburgh developed a robot that used its smart ears to find its way by means of echolocation, just like a bat. Jose Carmena, of the university's department of informatics, and his colleagues named this invention "RoBat." The RoBat was equipped with a central sound source, serving the same function as a bat's mouth, and two fixed receivers at a distance apart comparable to a bat's ears.

In order to make the best use of echoes, other features of the bat were also borne in mind when designing the RoBat. Bats move their ears to detect interference patterns in the echoes and thus, can easily avoid obstacles in front of them, navigate and hunt down preys. Like bats, the RoBat was also equipped with smart acoustic sensors to make its mechanism as flawless as possible.

Thanks to such nature-inspired sound sensors, it is hoped that one day our roads will be much safer.

In fact, such car manufacturers as Mercedes and BMW already use ultrasonic sensors to help drivers reverse. Thanks to them, the driver is alerted to how close he is to a car or other obstruction behind him.<sup>59</sup>



## A Fish's Detector Against Pollution

The West African elephant nose fish (*Gnathonemus petersii*) lives in 27°C (80°F) muddy waters of Nigeria. This 10 cm (3.9 in) fish uses its eyes very little in the muddy water. It finds its way by means of the electrical signals constantly given off by muscles in its tail. Under normal circumstances, it emits



300-500 signals a minute. As the pollution levels rise, however, the number of signals emitted per minute can exceed 1,000.

Detectors that make use of elephant nose fish are used to measure pollution levels in the British city of Bournemouth. A water company in the city gave specimens of water from the River Stour to be checked by 20 elephant nose fish. Each fish lives in an aquarium filled with water from the river. The receptor signals in the aquarium are forwarded to computers to which they are linked. If the water is polluted the increased numbers of signals emitted by the fish are identified, and the alarm signal is given by means of the computer.<sup>60</sup>



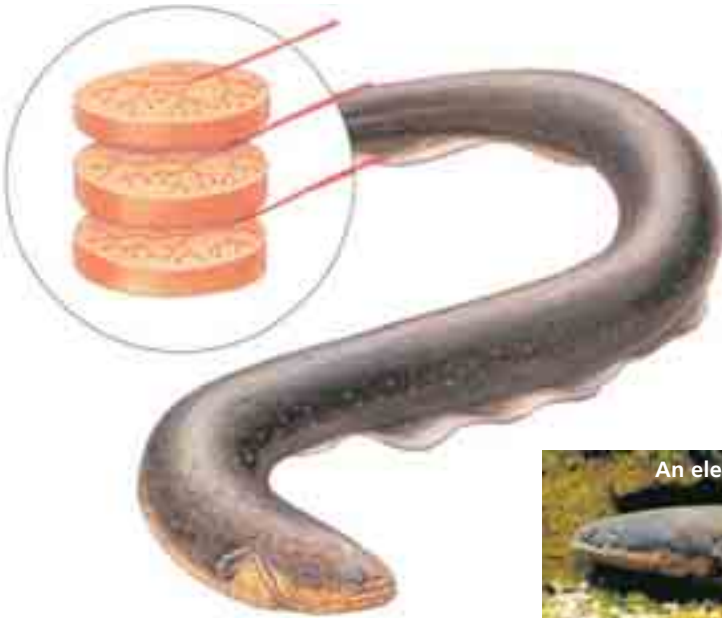

An electric eel

The electric eel *Electrophorus electricus* lives in the Amazon. Two-thirds of its two-meter long body is covered in 5,000 to 6,000 electricity-producing disc-like plates that produce 550 V / 2 A of electricity. The shock is sufficient to stun fish up to two meters away. ("Iste Doga," *Bilim ve Teknik*, Nov. 1985, 11.)

Scientists imitate the electric eel's defense mechanism, using the same principle as it employs today. That the eel can release such a strong discharge of electricity is truly a miracle of creation. It's out of the question for this exceedingly complex system involved to have come about in stages: If the fish's electricity production fails to function completely, it will give it no advantage. In other words, every part of the system must have been created flawlessly and at the same time.



An electric stun gun

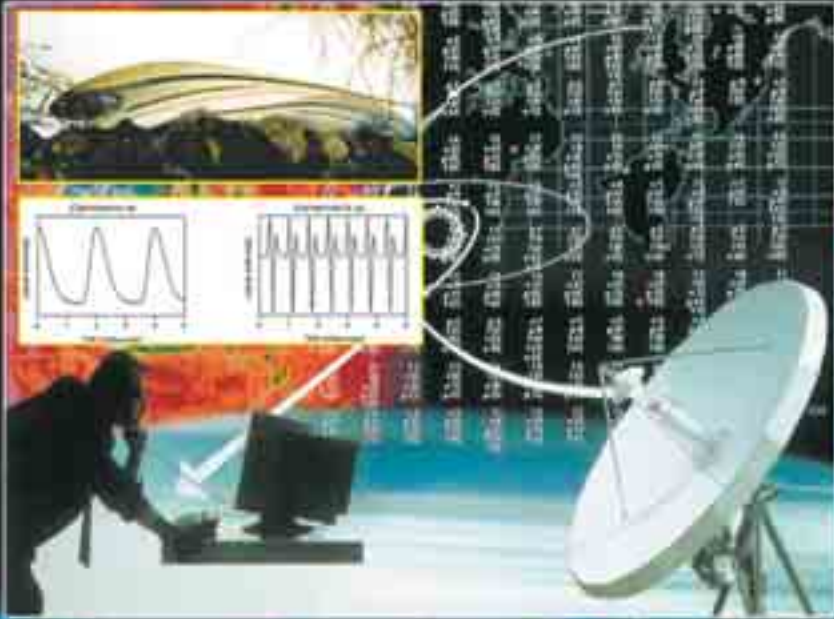

You can use electrical signals to locate an object or for communications, but need to have accumulated scientific technology to do so. Even today, very few countries have reached that level.

Yet some electric eels possess organic radar around their bodies that give off electrical signals that bounce back from its surroundings, letting the animal obtain information about the size, speed and motion of the objects around it.

The eel can also obtain information about the gender and maturity of another electric eel, and then invite it to mate or frighten it off. (W. M. Westby, "Les poissons électriques se parlent par décharges," *Science et Vie*, no. 798, Mar. 1984) Considering the complicated nature of our radar and communications systems, we can better understand the marvelous creation within the eel's body.



Harun Yahya



The glass knife fish (*Eigenmannia virescens*) locates objects in much the same way as humans calculate distance. We calculate distance according to the distance between sound waves and the time waves from the object take to reach our ear. This takes place in a little as 1/15,000 second. Instead of the sound waves, however, the glass knife fish emits electrical signals and detects perturbations in the self-generated electric field due to nearby objects. As California University researchers G. Rose and W. Heiligenberg discovered, the fish can perform these calculations in 400 billionths of a second, like a super-computer. ("Harika Balik," (Wonderful Fish), Hakan Durmus, *Bilim ve Teknik*, Mar. 1991, 43)





Chapter 5.

# LIVING THINGS AND FLIGHT TECHNOLOGY

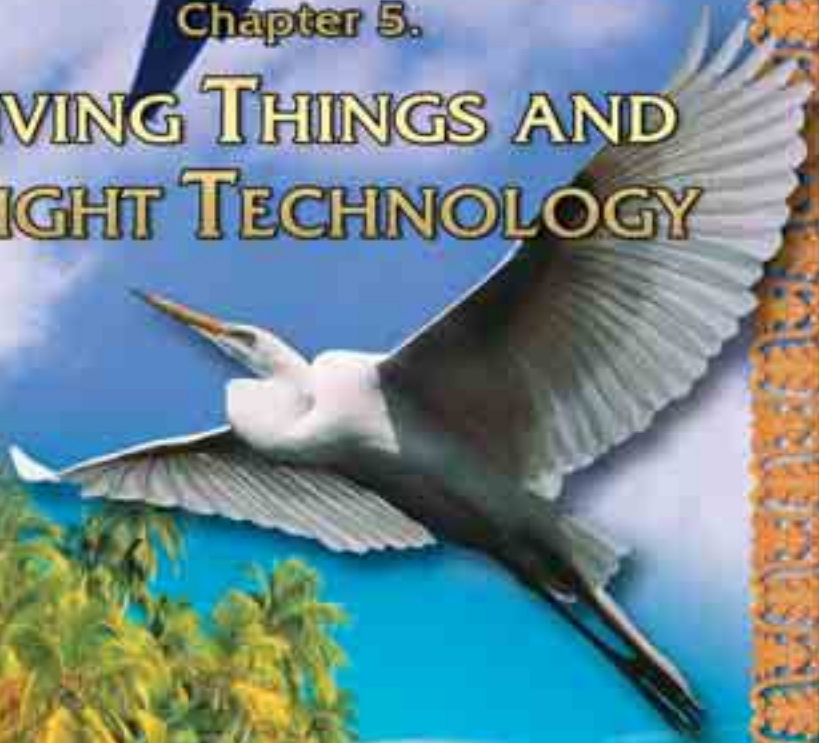



Which is the most flawless, efficient flying machine? A Skorsky helicopter, a Boeing 747 passenger jet, or an F-16 fighter?

The words, beginning a scientific article about birds in *Reader's Digest*, provide an answer to that question, stating that compared to birds, a marvel of aerodynamics, even the most advanced aircraft are nothing more than crude copies.<sup>61</sup>

Birds are perfect flying machines. Any vehicle needs to be fairly light in order to fly. This applies right down to the screws and bolts used to attach the wings. This explains why airplane manufacturers always try to use special materials that are light but also strong and resistant to blows. But despite all the efforts expended toward this goal, we humans are nowhere near birds in this field. Have you ever seen a bird explode or fall apart in mid-air? Or a bird lose a wing because the connections to its body have become weakened?

The flawless designs in birds have an enormous influence on the development of aviation. Indeed, the Wright brothers, regarded as the inventors of the airplane, used the vulture wing as a model when building the wings of their Kitty Hawk plane.<sup>62</sup>



Planes fly much faster than birds, but give off a lot of heat during flight. In a bird's body, however, the air circulation works just like a cooling system. It is therefore impossible to hit a bird with a heat-seeking missile as one can with a plane.

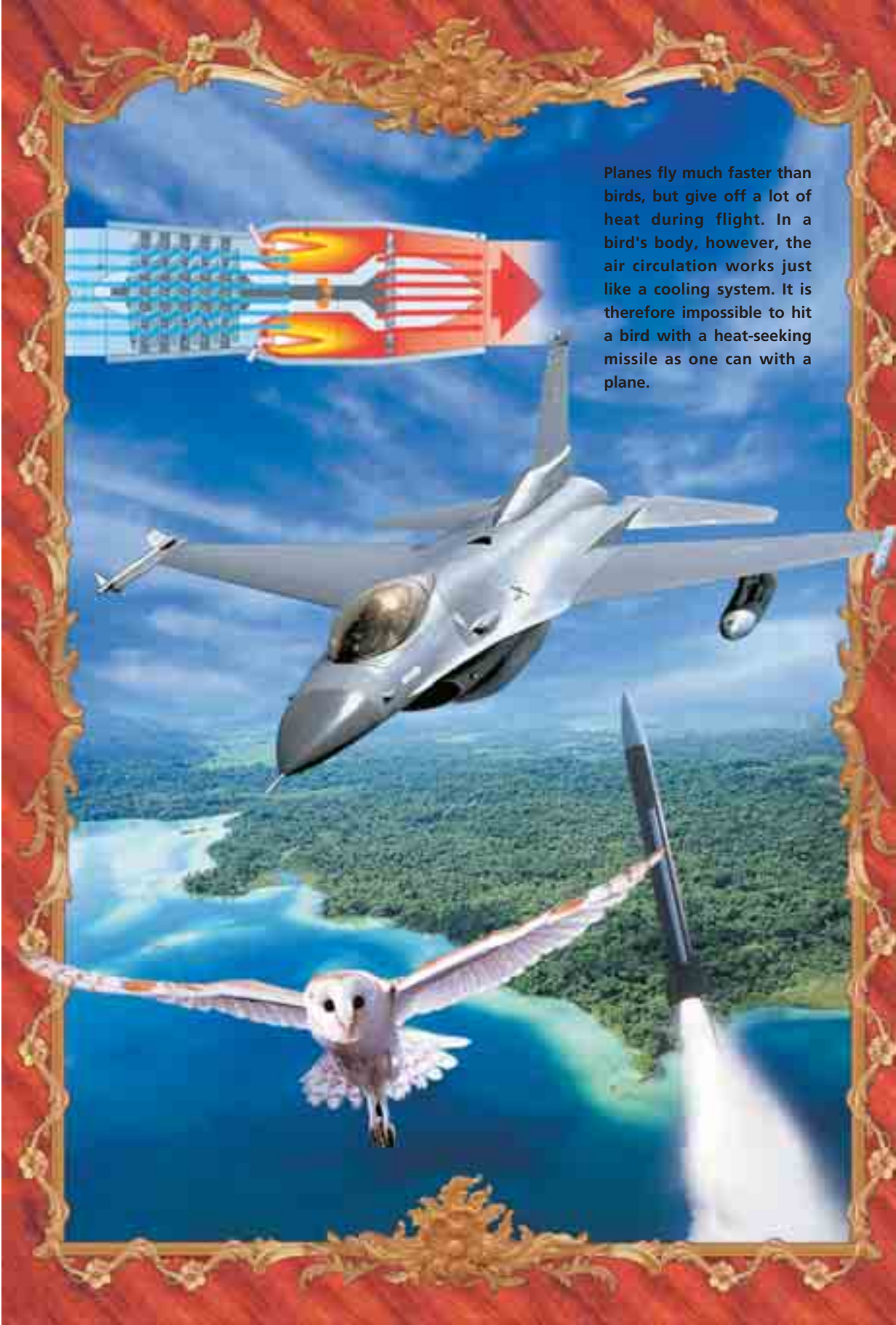

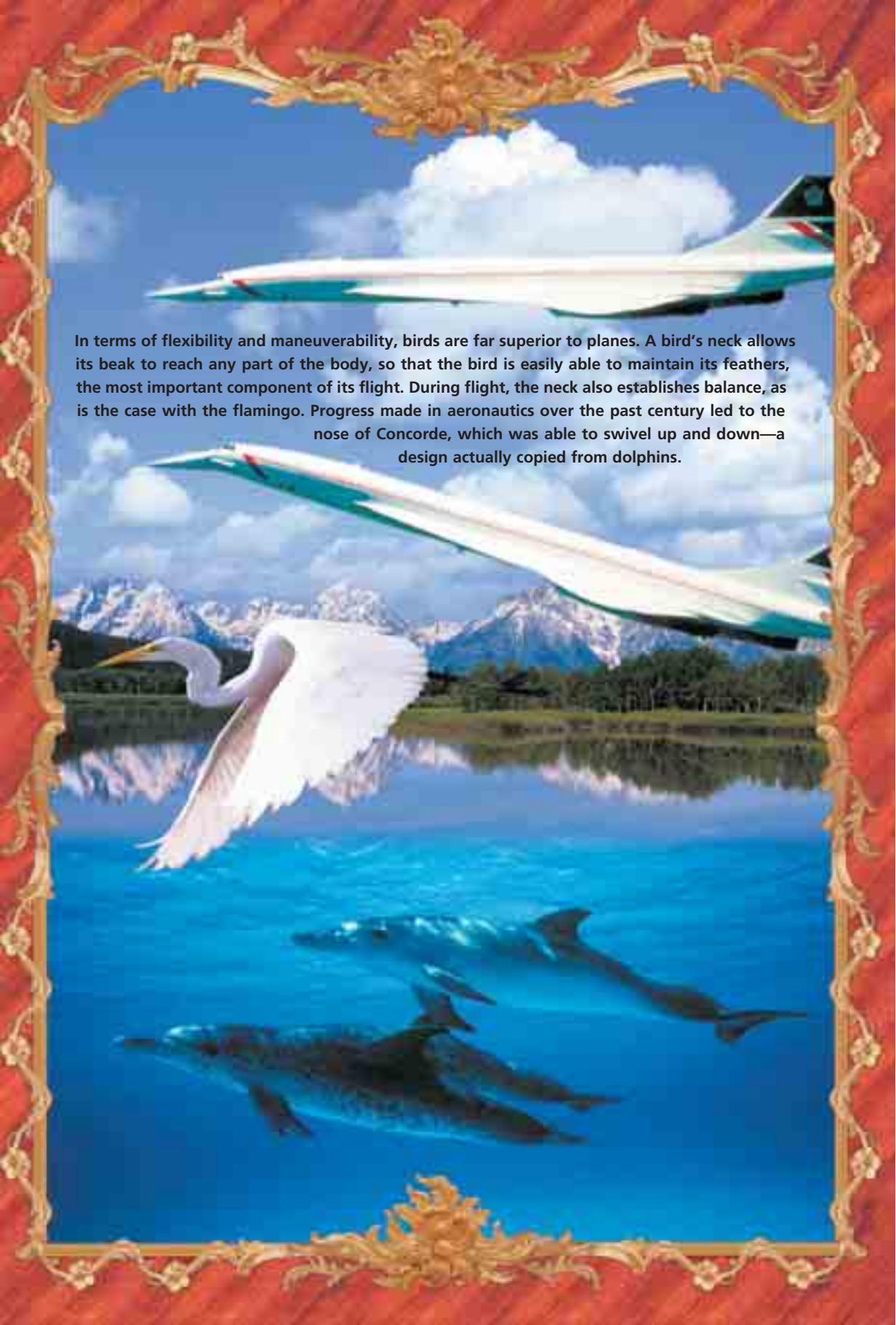

In terms of flexibility and maneuverability, birds are far superior to planes. A bird's neck allows its beak to reach any part of the body, so that the bird is easily able to maintain its feathers, the most important component of its flight. During flight, the neck also establishes balance, as is the case with the flamingo. Progress made in aeronautics over the past century led to the nose of Concorde, which was able to swivel up and down—a design actually copied from dolphins.



The flap of a plane (the movable surface attached to the rear edge of the wing that is used to create lift or drag) can't repair itself when damaged or even replace itself. Feathers, however, which serve the same function for birds, can do so, thanks to the impeccable system God gave them.





Try to tear a feather apart, and you'll meet considerable resistance, because filaments of the feathers are closely bound together by small hooks known as barbils. A split feather even has the power to repair itself. Just rubbing a feather a few times "with the grain" lets these tiny hooks grip themselves together once again.

Hollow bones, powerful chest muscles to move those bones, feathers with properties that enable them to remain in the air, aerodynamic wings, a metabolism that meets high energy needs... All these features, which clearly show that birds are the product of design, also give them extraordinary abilities in the air.

Birds are more advanced than planes in a great many other regards. Birds such as the raven and dove can turn somersaults in the air, and hummingbirds can remain suspended in flight. They can change their minds in flight and suddenly alight on a branch. No airplane can perform such maneuvers.



The *cobra* maneuver performed by Russian pilot Victor Pougatchev in his Su-27 jet has gone down in the history of aviation. The maneuver allowed Pougatchev to halt his plane in the air for a moment, causing an enemy plane to pass underneath. ("Yeni Avcı Uçakları:Pougatchev'in Kobraları," (New Hunter Planes: Pougatchev's Cobras) Asst. Prof. Selcuk Aslan, *Bilim ve Teknik*, Mar. 1990, 57-58.) Yet Pougatchev's maneuver is as nothing compared to what the hummingbird does.



Even before the airplane had been discovered, the flawless design employed by birds in order to fly influenced a great many inventors. As is recorded in early silent movies, in the 19th century some individuals actually tied homemade wings onto their arms and hurled themselves into space, trying to imitate the movements of birds. Predictably, it did not take them long to realize that wings alone were not enough to permit them to fly.

Since then, mankind has made considerable progress in terms of scientific techniques, and research and development. Yet some are still making claims at least as hollow and irrational as those early inventors. In their view, reptiles turned into birds gradually, stage by stage. This imaginary mechanism of gradual evolution has no foundation to support it. Birds possess a totally different structure from land-dwelling creatures. Their bone and muscle structure, feathers, aerodynamic wings and metabolisms bear not the slightest similarity to those of reptiles,<sup>63</sup> and the alleged gradual evolution model cannot account for even one of their bodily mechanisms.

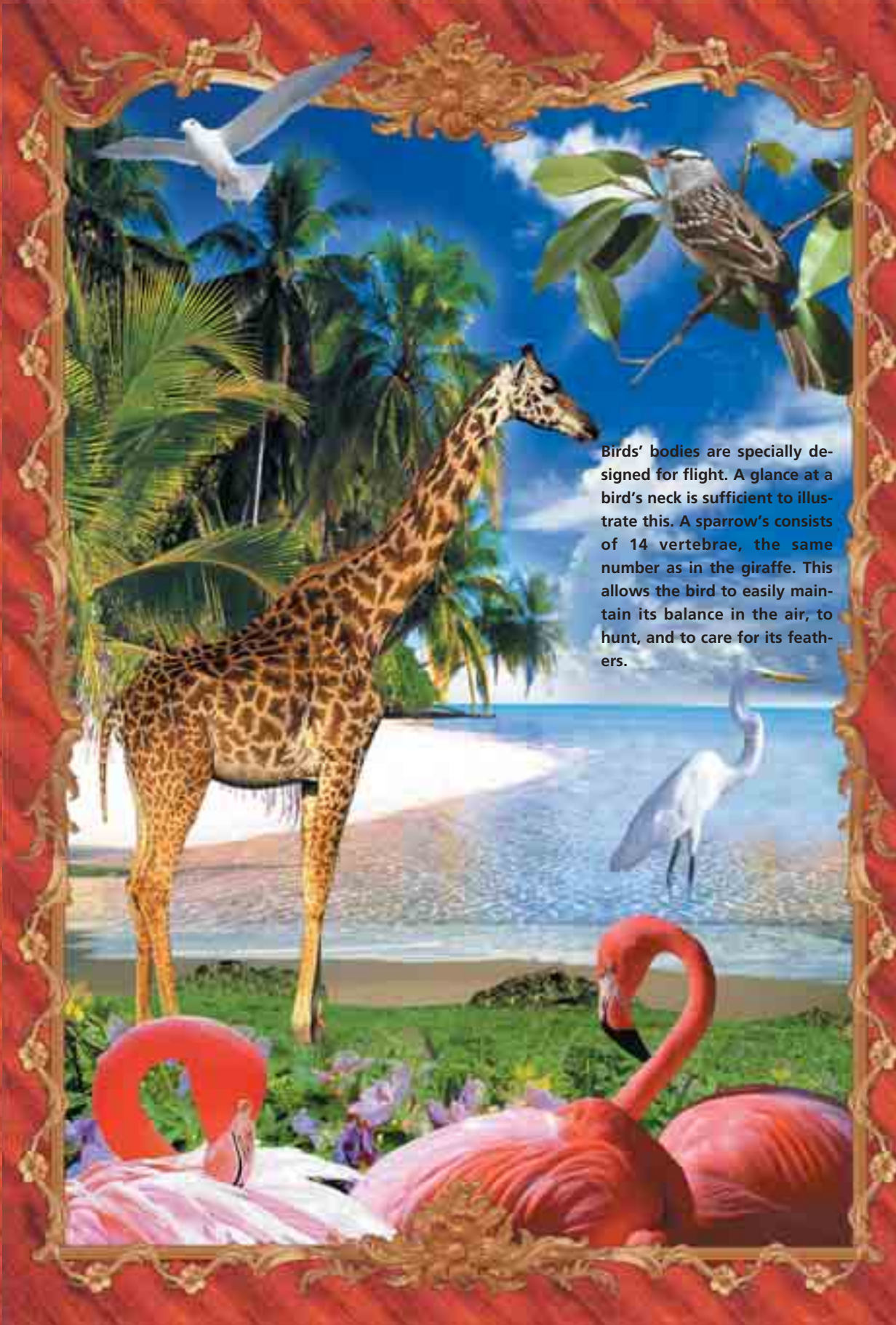

A composite illustration set within an ornate gold frame. The background is a tropical beach with palm trees, a white sandy shore, and blue water. A giraffe stands on the left, facing right. In the upper left, a white bird flies. In the upper right, a sparrow-like bird sits on a branch. In the lower right, a white egret stands near the water. In the foreground, there are two pink flamingos and a pink inflatable ring. The entire scene is set against a red background.

Birds' bodies are specially designed for flight. A glance at a bird's neck is sufficient to illustrate this. A sparrow's consists of 14 vertebrae, the same number as in the giraffe. This allows the bird to easily maintain its balance in the air, to hunt, and to care for its feathers.



Don't you see that  
everyone in the  
heavens and earth  
glorifies God, as do  
the birds with their  
outspread wings?  
(Qur'an, 24: 41)

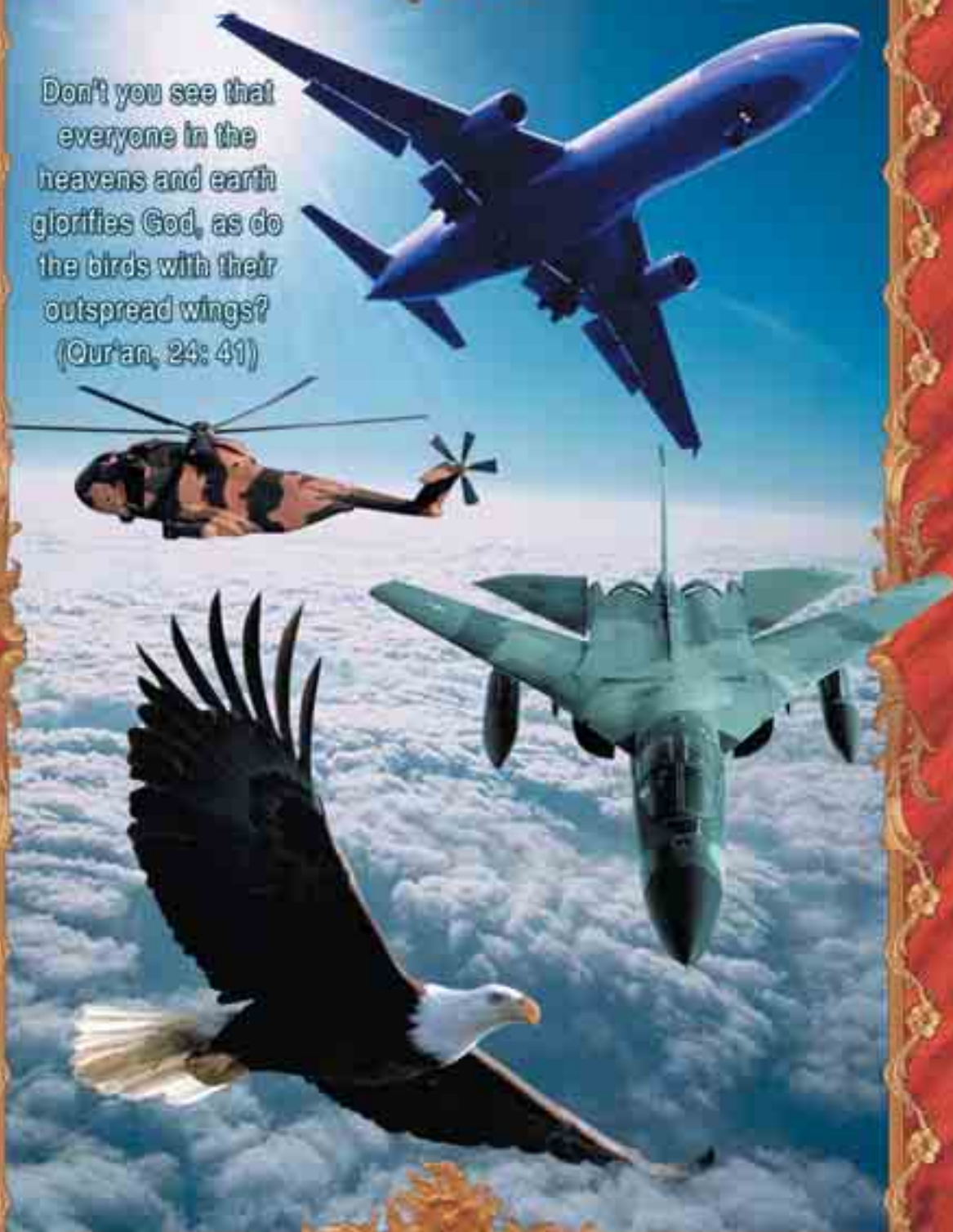

## The New Objective in Aeronautics: A Wing that Changes Shape According to Prevailing Conditions

As they fly, birds can use their wings in the most efficient way possible, automatically changing to deal with factors like temperature and wind. Currently, companies engaged in airplane technology are actively seeking to develop designs that make use of these features.

NASA, Boeing and the U.S. Air Force have designed a flexible wing, made of glass fibers, that can change its shape according to data from a computer inside the plane. This computer will also be able to process data from measuring equipment regarding flight conditions such as temperature, wind force, etc.<sup>64</sup>

Airbus, another firm working in this field, is trying to build adaptive wings that can change shape according to prevailing conditions, in order to reduce fuel consumption as much as possible.<sup>65</sup>

In short, birds' wing structures are literally a marvel of design. For many years, their matchless ability in flying has been a source of

**Birds' wing structures are a marvel of design. By their masterful use of the exact same wing structure, a bird can manage to fly in heat or cold, in windy or still conditions. This feature attracted scientists' attention and led them to try to produce a wing that could change shape according to changing conditions. The picture shows a cross-section of a wing designed with that purpose in mind.**

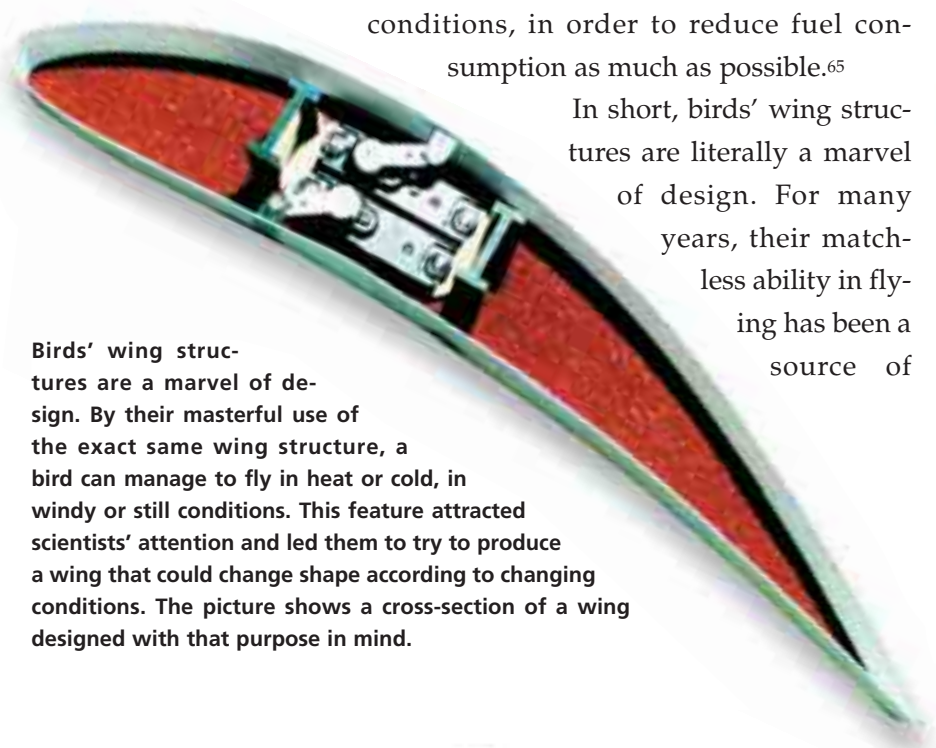



inspiration for engineers. God has equipped these creatures in the best possible manner for flight. He draws attention to them in the following verse:

**Haven't they looked at the birds above them, with wings outspread and folded back? Nothing holds them up but the All-Merciful. He sees all things.**

**(Qur'an, 67: 19)**



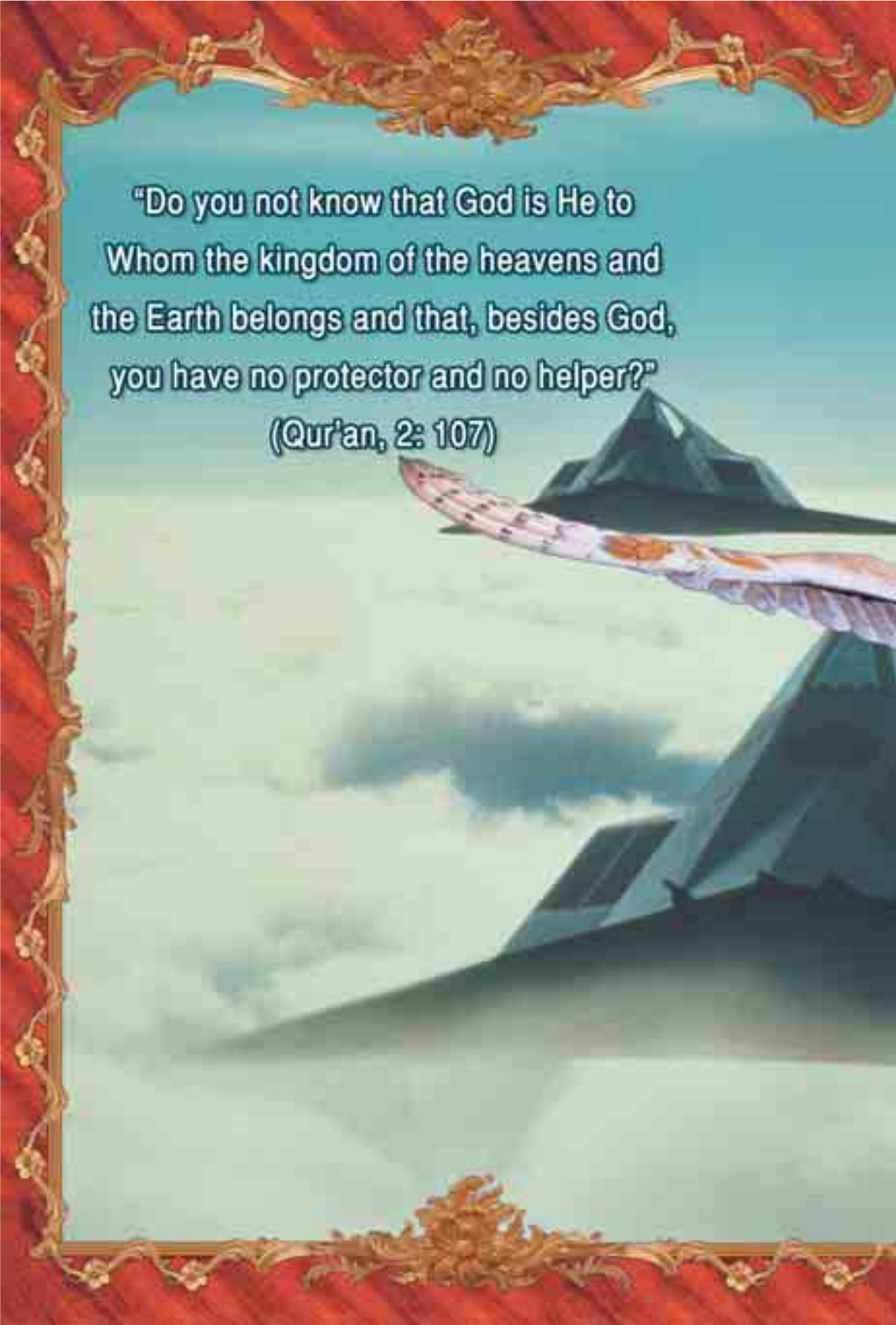

**"Do you not know that God is He to  
Whom the kingdom of the heavens and  
the Earth belongs and that, besides God,  
you have no protector and no helper?"**

**(Qur'an, 2: 107)**

Owls silently glide at night to catch their prey unawares, then suddenly swoop down. According to the findings of researchers at NASA's Langley Research Center in Virginia, an owl's flight feathers—unlike most birds, the flight feathers of whose have a sharp, clean edge—have soft fringes that decrease the turbulence, and thus the noise, of air as it flows over wing. Military designers hope that stealth airplanes can be made even stealthier by imitating the owl's wings. It is hoped that planes now invisible to radar will be completely silent. (Robin Meadows, "Designs from Life," *Zooger*, July/August 1999.)



## How Birds' Wings Are Shaping Flight Technology

The study of bird flight has led to important changes in the structure of airplane wings.

One of the first planes to make use of these changes was the American F-111 fighter. F-111 did not have control surfaces such as ailerons and flaps, which are used to control movements of the aircraft. Instead, just as birds do, the fighter could sweep its wings. This allowed it to remain balanced even while turning.<sup>66</sup>



The shape of birds' wings is the determining factor in their ability to fly. Wings of fast-flying birds like the falcon, hawk, and swallow are long, narrow and pointed—features that have served as a guide to flight engineers. ("Kusursuz Ucus Makineleri" (Perfect Flight Machines), *Bilim ve Teknik*, 23.)

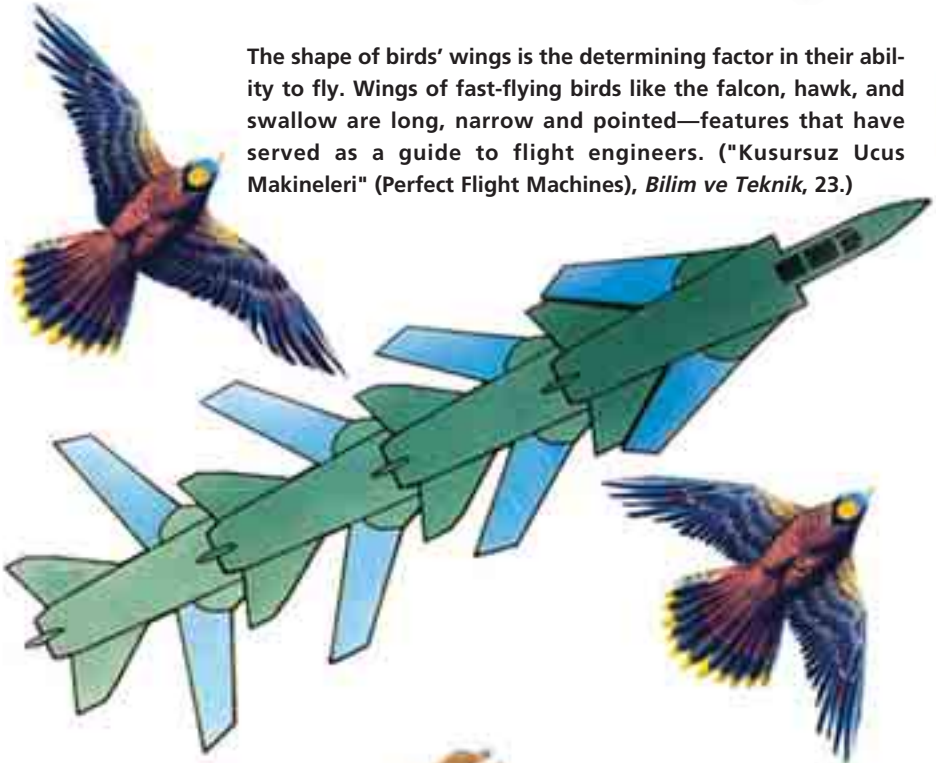



For high-speed flight, the most advantageous wing shape is one swept back. On the other hand, straight wings allow greater lift, important for takeoff and landing. The only way of benefiting from both these features is to construct variable-sweep wings, capable of moving backward and forward. (Clive Gifford, *Her Yonuyle Ucaklar*, (Cutaway Planes) TUBITAK, 4th ed., January 1999, 24.) Fighters such as the Tornado and F-111 have just such wings, the sweep of which can be changed in flight. This design, the result of long study, has been present in birds since the moment of their creation.



Inspired by bird bones—which are hollow, making them very light—the wings of modern planes are designed to be hollow also.

The albatross has long wings with a large surface area, allowing the bird to fly long distances without flapping its wings. Gliders designed along the lines of the albatross wing are thus able to remain in the air for long periods of time without the need for a propeller.

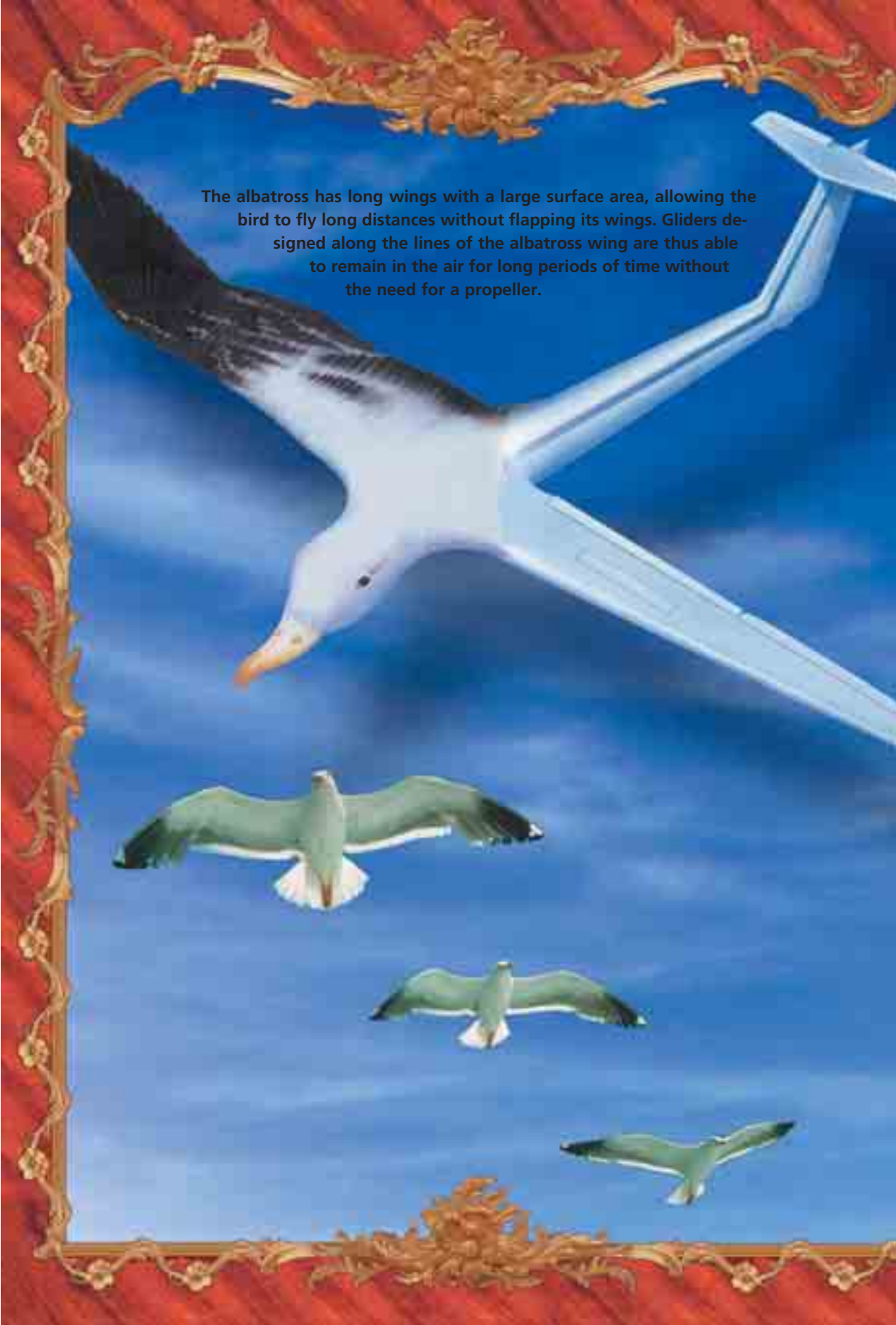

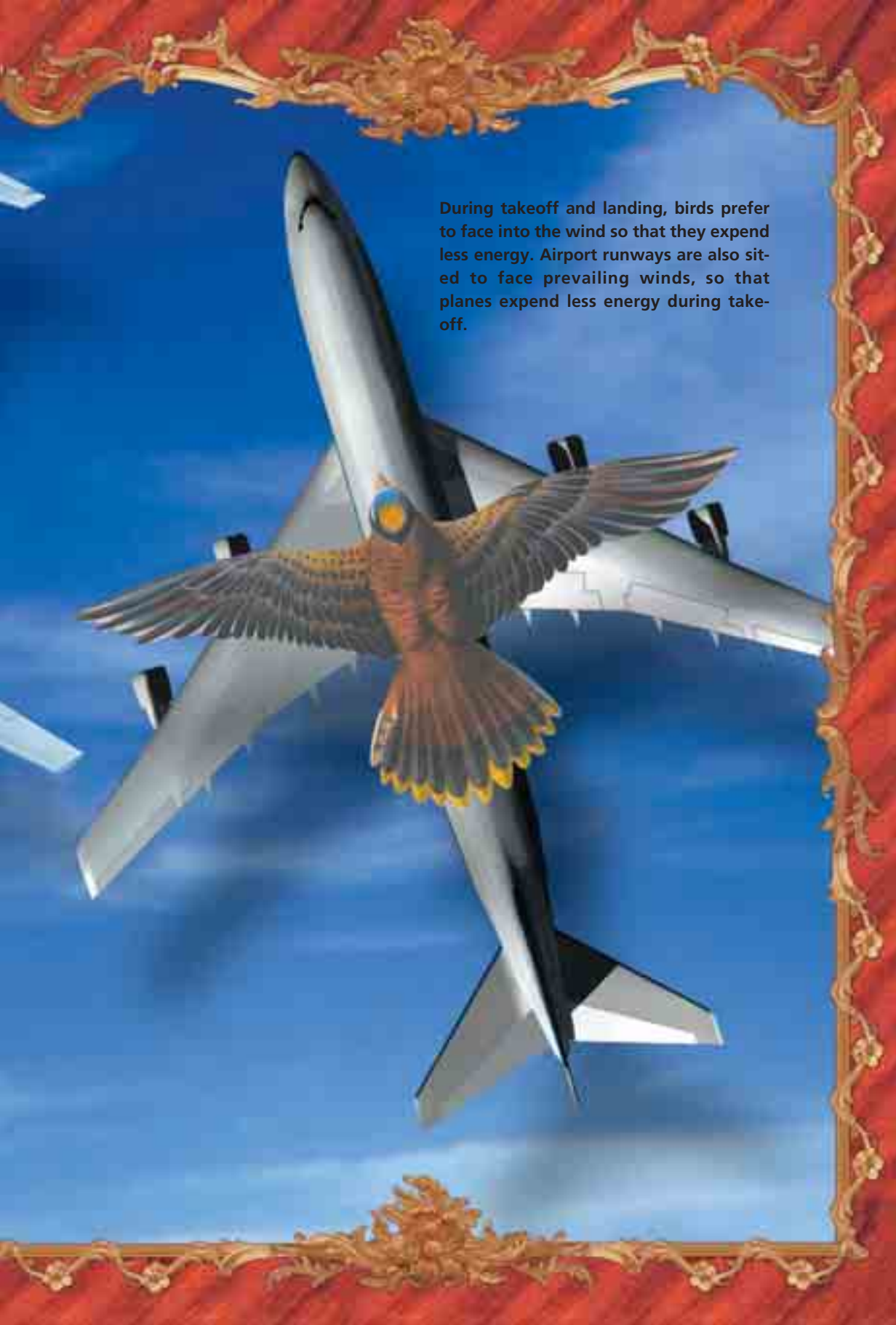

A composite image showing a large commercial airplane flying upwards against a blue sky with light clouds. In the foreground, a colorful bird with brown, blue, and yellow feathers is shown in flight, its wings spread wide, as if flying directly in front of the airplane. The entire scene is framed by a red, textured curtain with a gold, ornate border. The text is positioned in the upper right quadrant of the image.

During takeoff and landing, birds prefer to face into the wind so that they expend less energy. Airport runways are also sited to face prevailing winds, so that planes expend less energy during take-off.

## In Aviation Research, the Vulture's Feathers Show the Way

During a plane's flight, pressure changes at the wing's edge can form small vortexes—air currents at the edges of the wings that can impede flight performance.

Aviation research studies have revealed that when vultures fly, they open their quill feathers—the large feathers at the edge of the wing—like the fingers of a hand. From this observation, researchers thought of taking it as a model to make small metal ailerons and test them in flight. Using these, they hoped it would be possible to reduce the vortexes' unwelcome effects on a plane by setting up a series of smaller vortexes to replace the large ones that had previously been causing problems. Experiments proved this idea to be correct, and they are now seeking to implement it in real aircraft.

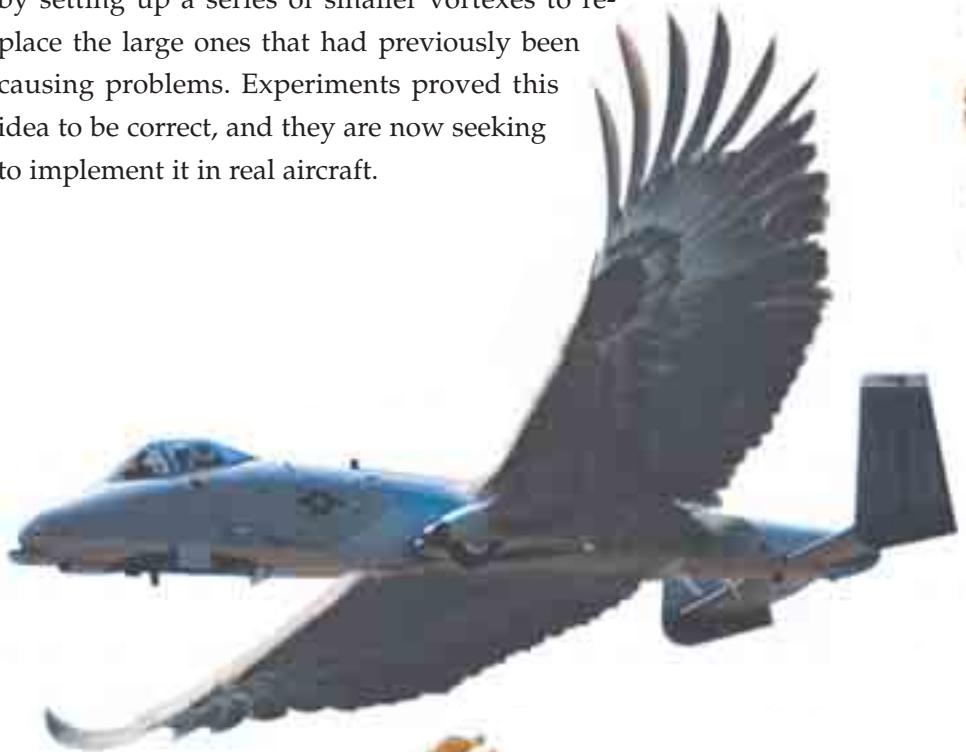

## 20th-Century Science Failed to Unravel the Aerodynamic Techniques That Insects Use to Fly

As an insect flies, it beats its wings an average of several hundred times a second. Some insects can even flap and rotate their wings 600 times a second.<sup>67</sup>

So many movements are carried out with such extraordinary rapidity that this design can't possibly be reproduced technologically. In order to reveal the flight techniques of fruit flies, Michael Dickinson, a professor in the department of integrative biology at the University of California, Berkeley, and his colleagues constructed a robot, called Robofly. Robofly imitates the insect's flapping motion, but on a 100-fold larger scale and at only a 1,000<sup>th</sup> of the fly's speed. It can flap its wings once every five seconds, driven by six computer-controlled motors.<sup>68</sup>

For years, many scientists like Professor Dickinson have been carrying out experiments hoping to discover the details of how insects flap their wings back and forth. During his experiments on fruit flies, Dickinson discovered that insect wings do not merely oscillate up and down, as if attached by a simple hinge, but actually use the most complex aerodynamic techniques. Moreover, the wings change orientation during each flap: The wing's top surface faces up as the wing moves downwards, but then the wing rotates on its axis so that the underside faces up as the wing rises. Scientists trying to analyze these complex motions say that the conventional steady-state aerodynamics, the approach that works for air-



Michael Dickinson

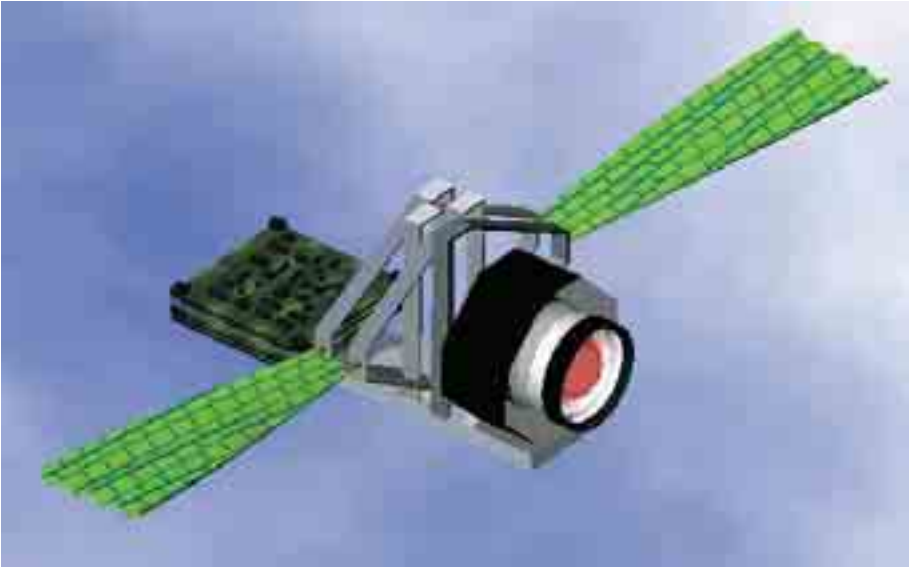

Scientists agree that considerable progress has been made in aviation technology. When it comes to micro-flapping flight, however, they admit that they are still at the same stage that the Wright Brothers were in 1903. Above: A micro-flight system modeled on insect wings. Right: The Wright Brothers' first plane.



plane wings, is insufficient.

Fruit flies actually make use of more than one aerodynamic feature. For example, when they flap their wings, they leave behind them a complicated whirlpool of air currents, rather like the wake of a ship. As the wing reverses direction, it passes back through this churning air, recovering some of the energy lost beforehand. The muscles that allow the fruit fly's only 2.5 mm wings to flap 200 times a second are considered as the most powerful of all insects' flight muscles.<sup>69</sup>

Many other details in addition to their wings, the flies' sharp eyes,

their small rear wings (known as halteres) aiding balance, and the sensors organizing the timing of the flapping motion, all testify to the perfection of their design.

Flies have been using these aerodynamic rules for millions of years. That today's scientists, equipped with the most advanced technology, can't fully account for insects' flying techniques is one of the evident proofs of creation. For those who are able to think, God reveals the incomparable nature of His wisdom and knowledge in the tiny fly. In one verse, He reveals:

**Humanity! An example has been made, so listen to it carefully. Those whom you call upon besides God are not even able to create a single fly, even if they were to join together to do it. And if a fly steals something from them, they cannot get it back. How feeble are both the seeker and the sought! (Qur'an, 22: 73)**

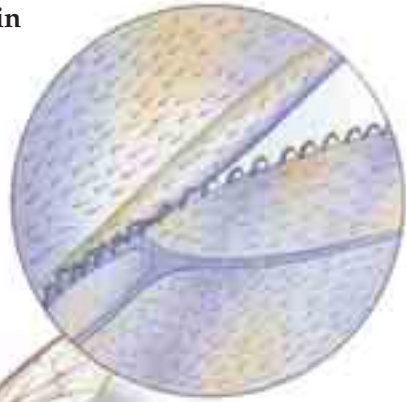

Large, flat wings give insects a flight advantage, but also a higher risk of the wings being damaged. They need to be foldable, therefore—yet the wings' size makes folding difficult. Bees solve this problem by means of a series of hooks known as the hamuli, which join the front and hind wings together in flight. When the bee lands, the hooks separate, and the wings can be comfortably folded away.



Chapter 6.

# WHAT WE CAN LEARN FROM ANIMALS





very single animal possesses many astonishing features given to it at creation. Some enjoy the ideal hydrodynamic form to allow them to move through water; others use rather outlandish sensory devices. Most of these are devices that mankind has encountered for the first time, or has just begun to grasp. Thanks to the science of biomimicry, products emerging from the imitation of these extraordinary discoveries will no doubt be employed frequently in our future.

### **Surface Drag and Swimsuits Inspired by Shark Skin**

In Olympic swimming competitions, 1/100th of a second can make the difference between winning and losing. Because the resistive drag opposing the motion of swimmers' bodies is of great importance, many swimmers choose newly-designed swimsuits that reduce the drag. These tightly fitting suits, covering a rather large area of the body, are made out of a fabric which was designed to mimic the properties of a shark's skin by superimposing vertical resin stripes.

Scanning electron microscope studies have revealed that tiny "teeth" (riblets) cover



the surface of a sharks' skin that produce vertical vortices or spirals of water, keeping the water closer to the shark's body and thus reducing drag. This phenomenon is known as the Riblet Effect, and research into shark skin is ongoing at NASA Langley Research Center.

Swimsuits made with new fibers and weaving techniques are produced to cling tightly to the swimmer's body and reduce drag as much as possible. Research has shown that such garments can reduce drag by 8% over ordinary swimsuits.<sup>70</sup>



The U-shaped channels on a shark's skin generate tiny vortices, bringing the water closer to the body and reducing drag. The large picture above shows a scanning electron microscope image of shark skin. ("Fizik, Teknoloji ve Olimpiyatlar" (Physics, Technology and Olympics), *Bilim ve Teknik*, 77.) At the Sydney Olympics, all gold-medal-winning swimmers like the Australian Ian Thorpe, wore swimsuits with the same properties as shark skin. This important development led to a new sphere of business activity. Firms such as Speedo, Nike and Adidas, well known bathing suit manufacturers, hired many experts in the fields of biomechanics and hydrodynamics.



## USA Takes the Viper as a Model in Its Defense

Dr. John Pearce, of the University of Texas Electrical and Computer Engineering Department, has studied *Crotalines*, better known as pit vipers.

His research focused on the pit organs of these snakes. In front of the snake's eye is a tiny nerve-rich depression, called the pit, which is used in locating warm-blooded prey. It contains a sophisticated heat-sensing system—so sensitive, in fact, that the snake can detect a mouse several meters away in pitch darkness.<sup>71</sup>

The researchers stated that when they unravel the secrets of the pit viper's search-and-destroy mechanism, the methods the snake employs can be adapted more widely to protect the country from enemy missiles. They hope to develop systems that will help pilots flying dangerous missions avoid enemy weaponry. Dr. Pearce says, "*The Air Force wants to see if they can mimic the biological system and get a better missile detector.*"<sup>72</sup> But so far, he explains that studies carried out to that end have found it difficult to match the snake's sensitivity:

*We're basically modeling the sensitivity of the snake organ. You can measure nerve impulses, but the question is, what do those impulses mean? We use a numerical*





*model to tell us: there's this much infrared hitting the organ, and that means this many nerve pulses.<sup>73</sup>*

The snake's pit is a thin membrane rich in blood vessels and nerve bundles. The membrane is so sensitive, and the variations in the responses so minute and subtle that to catch and study these signals has proved exceedingly difficult. To understand the functioning of the pit organ, it is necessary to work with delicate measurements and photomicrographs.

As this example shows, living things in nature display a superior intelligence and technology. Researchers investigating natural designs as their models thus acquire inspiration for projects that might otherwise last years and bring them to a conclusion in a much shorter time.

## Chameleons and Clothes that Change Color

The impressive ability that chameleons have to change colors to match their surroundings is both astonishing and aesthetically pleasing. The chameleon can camouflage itself at a speed that quite amazes people.

With great expertise, the chameleon uses its cells called chromatophores which contain basic yellow and red pigments, the reflective layer reflecting blue and white light, and the melanophores containing the black to dark brown pigment melanin, which darkens its color.<sup>74</sup>

For instance, place a chameleon into a bright yellow environment, and it quickly turns yellow. In addition, the chameleon can match not only one single color, but a mixture of hues. The secret behind this lies in the way pigment-containing cells under this master of camouflage's skin expand or contract to match their surroundings.

Current research under way at Massachusetts Institute of



The technology in color-changing clothes and the chameleon's ability to change color may appear similar, but are in fact very different. Even if this technology can change color, still it entirely lacks the chameleon's camouflage ability that lets it match its surroundings in moments.

Technology, USA, is aimed at making clothes, bags and shoes able to change colors the same way as the chameleon does. Researchers envision clothing made from the newly developed fiber, which can reflect all the light that hits it, and equipped with a tiny battery pack. This technology will allow the clothing to change colors and patterns in seconds by means of a switch on the pack.<sup>75</sup> Yet this technology is still very expensive. For instance, the cost of a color-

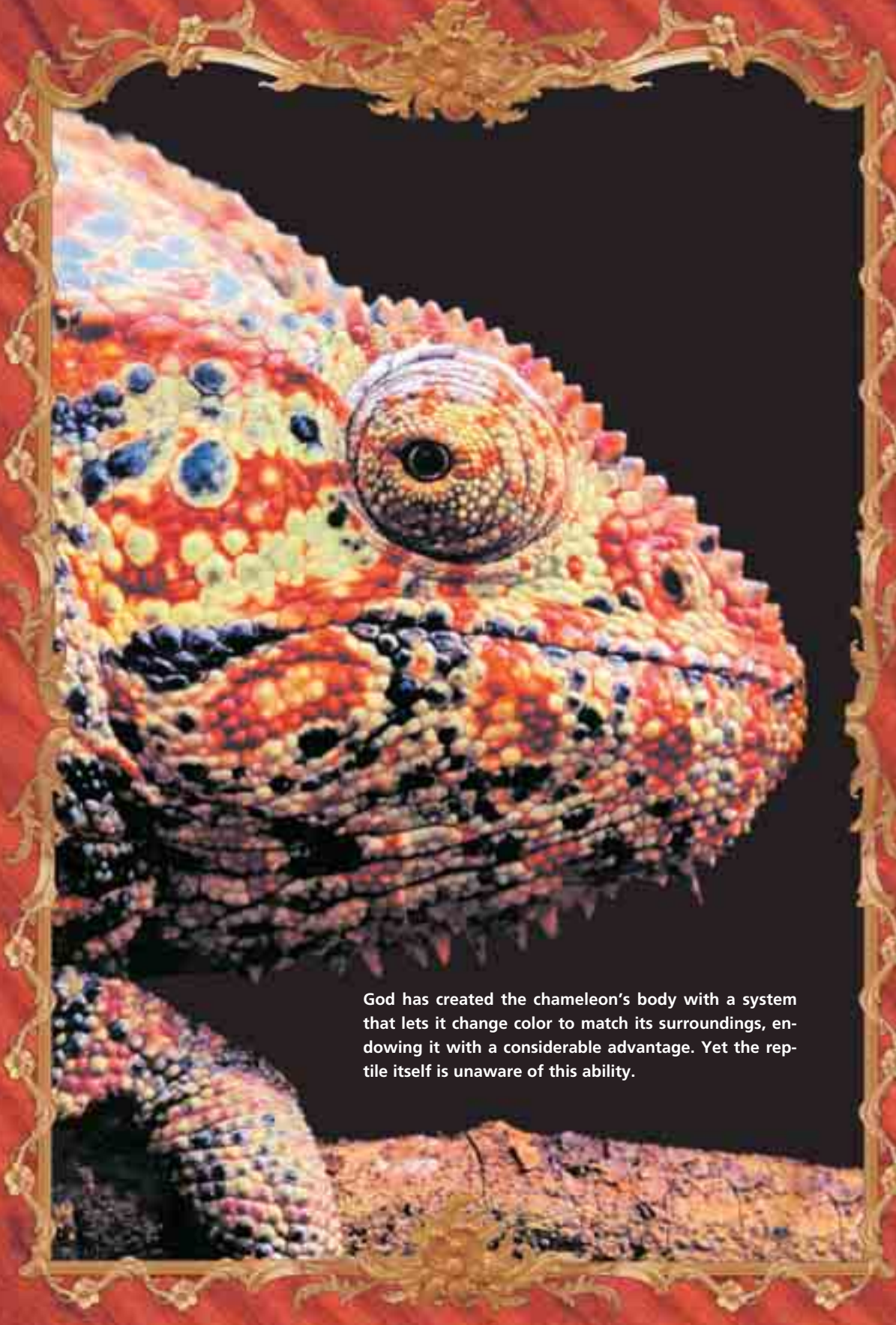

God has created the chameleon's body with a system that lets it change color to match its surroundings, endowing it with a considerable advantage. Yet the reptile itself is unaware of this ability.

changing man's jacket is around \$10,000.

What would you think if someone showed you a jacket and claimed, "This can change color. Yet nobody prepared the jacket, nor its ability to change color. It all just happened by itself." Probably you'd imagine that person to be mad or else very ignorant. Quite clearly, there must have been a tailor to put it together, and even before that, engineers to create its ability to change color.

So, how can the chameleon carry out these impeccable changes? Did it design the systems that permit the change, install them inside its own body, and carry out the processes all by itself? Of course it would be most irrational to claim that the chameleon did this all of its own free will. Since even human beings find it definitely impossible to bring about such a change, how can a reptile install a system capable of changing its own body's appearance? To claim that such a superior ability came about by chance is nonsensical and invalid.

No natural mechanism has the power to form such impeccable abilities and bestow them on the living things that need it. A superior power rules the atoms, molecules, and cells in the creature's body and arranges them as it wishes. God, Who created the chameleons, reveals to us the incomparable nature of His creation in such examples. As is revealed in the Qur'an, God is All-Powerful:

**Everything in the heavens and the earth glorifies God. He is the Almighty, the All-Wise. The kingdom of the heavens and the Earth belongs to Him. He gives life and causes to die. He has power over all things. (Qur'an, 57: 1-2)**

## 515-Million-Year-Old Optic Design

In an article published in *American Scientist*, the well-known US scientific magazine, Andrew R. Parker states that he and his colleagues examined a mummified fly preserved in amber resin for 45 million years. There was a periodic grating structure on the curved surfaces of the fly ommatidia (individual visual organs composing the fly's compound eye). Analyzing the reflective properties of this structure, they realized that the fly-eye structure was a very efficient antireflector, particularly at high angles of incidence. This hypothesis was indeed confirmed in later studies.

Thanks to these findings and others, today's scientists have determined how to greatly increase the efficiency of solar absorbers and solar panels used to provide energy for satellites. Work is currently under way





to reduce the angular reflection of infrared (heat) and other light waves by mimicking the fly-eye structure. Most suitable for use in solar panel surfaces, the fly-eye grating has also done away with the necessity for expensive equipment to ensure that these panels are always directly facing the Sun.<sup>76</sup>

Only recently have space technologists discovered and imitated this design, but flies have possessed it for millions of years. Similar structures have recently been discovered also on some Burgess Shale fossils, 515 million years old. Permitting very acute and color vision, this design shows just what a superior product of creation it really is. But such evidence can be comprehended only by believers—those who can use their reason to comprehend

that everything that exists is under God's control.

One verse describes how similar proofs mean nothing to those who deny God:

**God is not ashamed to use the example of a mosquito or of an even smaller thing. As for those who believe, they know it is the truth from their Lord. But as for those who do not believe, they say, "What does God mean by this example?" He misguides many by it and guides many by it. But He only misguides the deviators. (Qur'an, 2: 26)**

### ***Stenocara*: A Fully-Fledged Water Capturing Unit**

In the desert, where few living things are to be found, some species possess the most astonishing designs. One of these is the tenebrinoid beetle *Stenocara*, which lives in the Namib Desert, in Southern Africa. A report in the November 1, 2001, edition of *Nature* describes how this beetle collects the water so vital to its survival.

*Stenocara*'s water capture system basically depends on a special feature of its back, whose surface is covered with tiny bumps. The surface of the regions between these bumps is wax-coated, though the peaks of the bumps are wax-free. This allows the beetle to collect in a more productive manner.

*Stenocara* extracts from the air the water vapor that occurs only rarely in its desert environment. What is remarkable is how it separates out the water from the desert air, where tiny water droplets evaporate very quickly due to heat and wind. Such droplets, weighing almost nothing, are borne along parallel to the ground by the wind. The beetle, behaving as if

it knew this, tilts its body forwards into the wind. Thanks to its unique design, droplets form on the wings and roll down the beetle's surface to its mouthparts.<sup>77</sup>



The article about *Stenocara* included the following comment: "*The mechanism by which water is extracted from the air and formed into large droplets has so far not been explained, despite its biomimetic potential.*"<sup>78</sup>



Examining the features of this beetle's back under an electron microscope, scientists established that it's a perfect model for water-trapping tent and building coverings, or water condensers and engines. Designs of such a complex nature cannot come about just by themselves or through natural events. Also, it's impossible for a tiny beetle to have "invented" any system of such extraordinary design. Just *Stenocara* alone is sufficient to prove that our Creator designed everything that exists.

### 100% Efficient Light-Generating Fireflies

From the tip of their abdomens, fireflies produce greeny-yellow light. This light is produced in cells containing a chemical called luciferin, which reacts with oxygen and an enzyme known as luciferase. The beetle can turn the light on and off by varying the amount of air entering its cells from its breathing tubes. A normal household bulb has a productivity level of 10%, the other 90% of the energy being wasted as heat. But in a firefly, almost 100% of the energy produced is light, representing with this very efficient process, a target for scientists to aim for.<sup>79</sup>

What force allows fireflies to engage in such a high level of efficiency? According to evolutionists, the answer





lies in unconscious atoms, happenstance, or other external factors with no propulsive force; none of which can possess the power to actually initiate such productive activity. God's art is infinite and incomparable. In many verses of the Qur'an, God speaks of the need for people to use reason to consider and draw lessons from what He has created. Therefore, man's responsibility is to consider God's miracles and turn only towards Him.

## A Solution to Traffic Problems from Locusts!

Auto accidents cost millions of lives every year. In its search for a solution, the scientific world now believes that locusts might offer just such a remedy. Even though locusts travel in swarms of millions, research has shown that they never collide with one another. The answer to how locusts avoid doing so led to the opening of a whole new scientific horizon.

Experiments determined that locusts send out an electronic signal to any body approaching them to identify that body's location, and then change direction accordingly.<sup>80</sup>

Inventors are now trying to implement the method locusts employ in order to resolve a problem that has remained in-



tractable for years. These creatures, behaving in the way God inspires them to, are among the clearest proofs of creation.

### **Birds' Flight Methods as a Model for High-Speed Trains**

When Japanese engineers and scientists were designing their high-speed 500-Series electric trains, they encountered a major problem: Examining wild birds for the perfect solution, soon they found the design they were seeking and implemented it successfully.

#### **Owl Flight and High-Speed Train Noise**

In the high-speed trains developed by the Japanese, safety is one of the most important factors. A second is compatibility with Japanese environmental standards. Japan's noise regulations regarding railway operators are the strictest in the world. Using current technology, it's not actually that difficult to go faster, though it's hard to eliminate noise while doing so. Under Japanese Environment Agency regulations, a railway's



noise levels must not exceed 75 decibels at a point 25 meters (82 feet) away from the center of railway track in urban areas. At a crossing in a town, when cars start to move all at once on the green light, they create more than 80 decibels. This goes to show just how quiet the high-speed Shinkansen train must be.



The reason for the noise that a train produces up to a certain operation speed is the rolling of its wheels on the tracks. At speeds of 200 kmph (125 mph) or over, however, the sound source becomes the aerodynamic noise caused by its movement through the air.

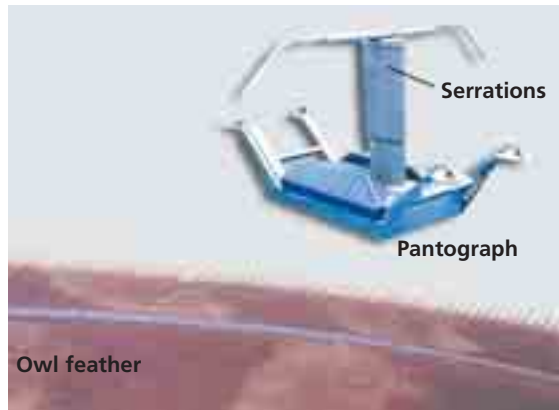

The major sources of aerodynamic noise are the pantographs, or current collectors, used to take in electricity from overhead catenary. Engineers, realizing that they couldn't reduce noise levels with the conventional rectangular pantographs, concentrated their research on animals that move quickly, yet silently.

Of all birds, owls make the least noise during flight. One of the ways they manage this is through the plumes of their wings. In addition, an owl's wings have many small saw-toothed feathers (serrations) visible

even to the naked eye, which other birds lack. These serrations generate small vortexes in the air flow. Aerodynamic noise stems from vortexes forming in the air flow. As these grow in size, the noise increases. Since owls' wings feature many saw-toothed projections, they form smaller vortexes instead of large ones, and the owls can fly very quietly.

When Japanese designers and engineers tested stuffed owls in a wind tunnel, they once again witnessed the perfection of these birds' wing design. Later, they succeeded in efficiently reducing train noise by using wing-shaped pantographs based on the principle of the owl's serrations. Thus the pantograph system developed by the Japanese, inspired by nature, became the quietest functioning.<sup>81</sup>

### **The Kingfisher's Dive and High-Speed Trains' Entry into Tunnels**

The tunnels on the lines used by high-speed trains represented another problem for engineers to solve. When a train enters a tunnel at a high speed, atmospheric pressure waves rise up and gradually grow up to be like tidal waves that approach the exit of the tunnel at the same sonic speed. At the exit, the waves then return. At the tunnel's exit, part of the pressure waves is released with a sometimes explosive noise.



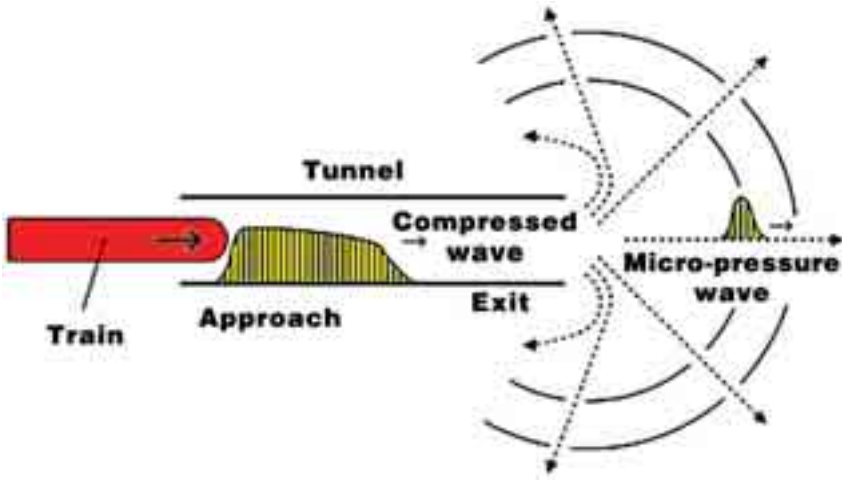

Since the pressure of the waves is about one thousandth of atmospheric pressure or less, they're referred to as tunnel micro-pressure waves, which form as shown in the diagram.

The very disturbing noise created under the influence of the pressure waves can be reduced by widening the tunnel, but the task of altering the cross-sectional area of tunnels is very difficult and expensive.

At first, engineers thought that reducing the cross-sectional area of trains and making the forefront shape sharp and smooth might be a solution. They put these ideas into action in an experimental train, but remained unable to eliminate the micro-pressure waves it created.

Wondering if similar dynamics arose in nature, the designers and engineers thought of the kingfisher. In order to hunt its prey, the kingfisher dives into water, which has greater fluid resistance than air, and it experiences sudden





To catch its prey, the kingfisher dives from low-resistance air into high-resistance water. Just as the bird's beak facilitates such a dive, it also prevents its body from harm. But the kingfisher still needs to be able to see its prey as it dives into the water. God has created the bird with a protective mechanism to protect its eyes without hindering its ability to see and seize its prey underwater. When one bears in mind the fact that underwater objects appear to be somewhere else than where they really are when one looks at them from above the water, the importance of this becomes even clearer.

changes in the resistance like a train does when it enters a tunnel.

Accordingly, a train traveling at 300 kmph (186 mph) needs to have a forefront shape like a kingfisher's beak, which facilitates the bird's diving.

Studies conducted by the Japanese Railway Technical Research Institute and the University of Kyushu revealed that the ideal shape to suppress tunnel micro-pressure waves was a shape of revolving paraboloid or a wedge. A close-up cross-section of a kingfisher's upper and lower beak form precisely this shape.<sup>82</sup> The kingfisher is yet another example of how all living things are created with exactly what they need to survive—and whose designs can serve as models for human beings.



## Peacock Feathers and Self-Changing Display Signs

In a peacock's feathers, the keratin protein together with the brown feather pigment melanin, the only pigment these feathers contain, allow light to refract so that we can see the color. The light and dark colors we see in feathers derive from the directional layering of keratin. Peacock feathers' exceedingly bright hues stem from this structural feature.



Nature inspired one Japanese company to develop reusable display signs, whose surfaces are structurally altered under ultraviolet light which changes the materials's crystalline alignment, thus eliminating certain colors so as to display the desired message. These signs can be used over and over and imprinted with new images. This eliminates the cost of producing new signs, as well as the need for using toxic paints.<sup>83</sup>



## A Computer Solution from Butterflies

We use computers so extensively that they've become part of every moment of our lives 24 hours a day—at home, at work, even in our cars. Computer technology is developing rapidly day by day, and increasing living standards require of computers' functioning to increase at the same pace, growing faster all the time. The latest models can achieve breathtaking speeds, and faster chips mean that computers can carry out more tasks in less time. However, faster chips lead to greater consumption of electricity, which warms up the chips as a result. It is essential for computer chips to be cooled down to prevent them from melting. The existing fans are no longer sufficient to cool down the latest generation of chips. Designers seeking a solution to this problem eventually declared that they had found a solution in nature.

Butterfly wings contain a perfect structure in their design. Research carried out at Tufts University has revealed that there is a cooling system in butterfly wings. When this system is compared to that in computer





chips, it has a much better performance. A team headed by assistant research professor of mechanical engineering Peter Wong was funded by the American National Science Foundation to study how iridescent butterflies control heat.

Since butterflies are cold-blooded, they have to constantly regulate their body temperatures. This is a serious problem, because friction during flight leads to considerable quantities of heat. This heat needs to be cooled down at once. Otherwise, the butterfly will not survive. The solution is provided by the millions of microscopic scales, called thin-film structures, clinging to their wings. The heat generated is thus dispersed.<sup>84</sup>

The team estimates that this research will become useful for chip manufacturers like Intel and Motorola in the near future. But in butterflies, this matchless design has been around for as long as they have. That butterfly wings embody such a flawless solution introduces us to the wisdom and power of the Creator. That power belongs to God, Who has dominion and power over all.

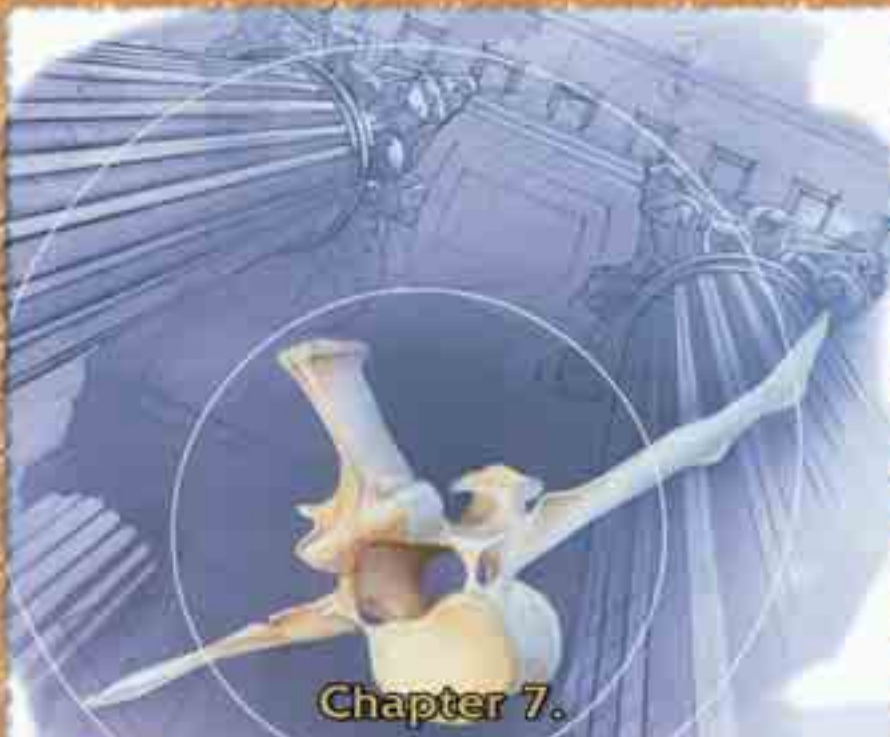

Chapter 7.

# ORGANS SUPERIOR TO TECHNOLOGY





July 12, 2001 news release published by America's Sandia National Laboratories announced that as a result of their work, they had "approached the visual acuity of the eye itself." The report stated that using 64 computers, a digital image was produced that took them only seconds to acquire.<sup>85</sup>

This is a most important development, yet one point shouldn't be forgotten. In as little as one-tenth of a second, human eyes form an image that takes up no more space than one square millimeter on the retina. With this in mind, it can be seen that the human eye is much faster and more functional than 64 computers, using the very latest technology.

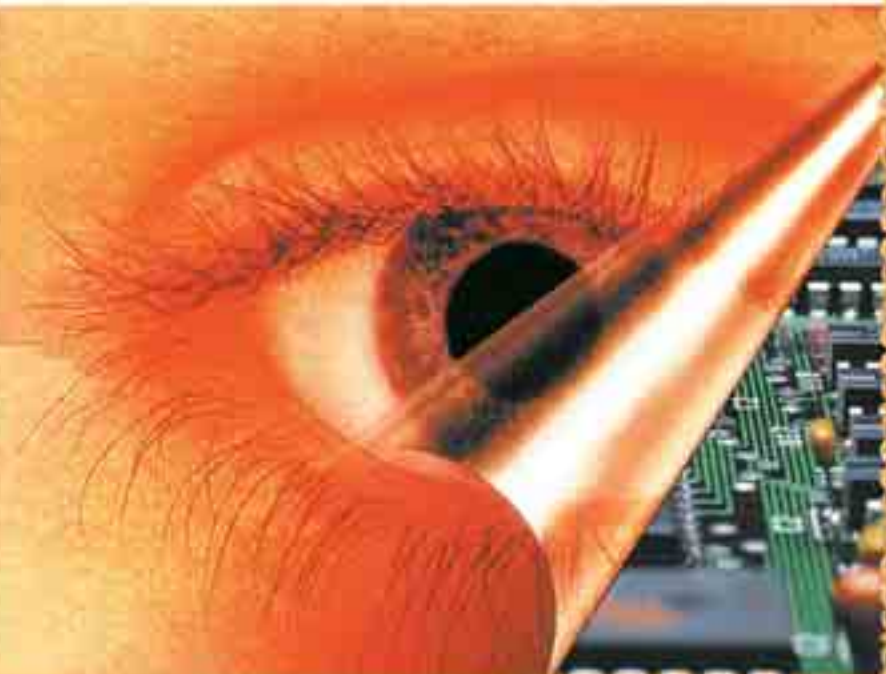

## Technology Is Unable to Match the Design in the Human Heart

Human beings live for an average of between 70 and 80 years. The human heart beats some 70 to 80 times a minute, for a total of several billion times during the course of an individual's lifetime. The Abiomed company, known for its research into artificial hearts, has stated that despite all its work, it will be unable to imitate the flawless functioning that the heart displays successfully over the years. For the company's newly-developed artificial heart to beat 175 million beats, or about five years, appears a significant target.<sup>86</sup>

A product of the latest technology, this artificial heart was tested in calves before human beings, although the calves survived for only a few months. The artificial heart developed by the company has been put in safety trials in human heart failure patients in 2004. But, obviously researchers find the human heart so difficult to imitate. Steven Vogel of Duke University, a biomechanic who has also written a book on this sub-

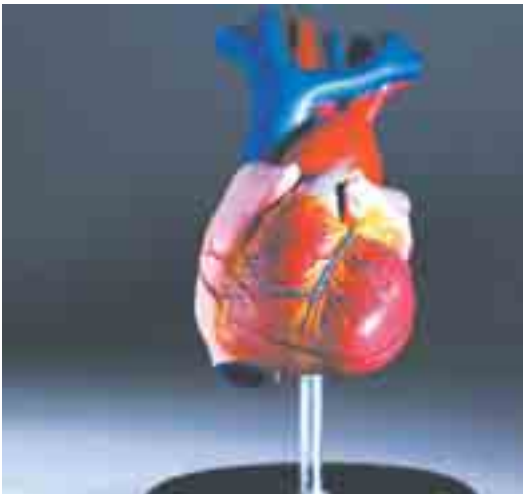

Alan Snyder

ject, describes why:

*It's that the engines we have available, whatever their power output or efficiency work so differently. Muscle is a soft, wet, contractile engine, and that's just unlike anything in our technological armamentarium. So you can't imitate a heart . . .*<sup>87</sup>

Like the genuine article, Abiomed's artificial heart consists of two ventricles. There the similarity ends, however. Alan Snyder of Penn State, a bioengineer who led the research, explains the difference in these terms: "In the natural heart, you're using muscle as a container and the container pumps on its own."<sup>88</sup> Pumps that work along the same lines as the heart contain a container *and* a system that pumps the fluid. In the heart, however, the container carries out its own pumping. That is the difference Snyder summarized.

Researchers, wondering how to make a heart that contracts by itself, set the interior walls of the two ventricles into motion by placing a separate engine between them. This artificial heart works with a battery located in the patient's abdomen. This battery has to be recharged continuously by radio waves emitted by a rechargable battery pack patients will wear in a harness.

Our natural hearts, on the other hand, have no need of a battery for energy, because they boast an incomparable muscular design capable of creating its own energy in every cell. Another feature of the heart that can't be replicated is the incomparable efficiency of its pulses. In fact, the heart can pump five liters of blood a minute while at rest, which can rise to 25-30 liters during exercise. Kung, Abiomed's director, describes this extraordinary change of tempo as "a challenge that currently no mechanical device can meet." The artificial heart made by the company can only



pump 10 liters a minute at best, which is not sufficient for a great many ordinary activities.<sup>89</sup>

The real heart is nourished and strengthened according to its needs by the blood it pumps. Such a heart can work for 50 to 60 years with no need for repairs. The heart possesses the capacity for self-renewal, which is why it never loses its ability for uninterrupted work. This is yet another feature that makes it impossible to imitate artificially.

Our heart, which scientists can only dream of matching with present-day technology, shows to us the superior knowledge of our Creator and our Great Lord—God.

### **From the Immune System, a Solution to the Computer Virus Menace**

Once a single computer is affected by a virus, this means that other computers in the world may soon be contaminated as well. Many companies, therefore, have seen it necessary to set up an “immune system” to protect their network systems from viruses and continue to carry out intensive research in this area. One of the centers that is carrying out this work is the virus isolation laboratory at the IBM's Watson Research Center in New York. There, a high-security microbiology laboratory works with lethal viruses, also producing programs that can diagnose the 12,000 or so viruses identified so far—and also isolate the viruses from a computer in a safe manner and then kill them.

IBM is only one of the firms trying to construct a worldwide immune system to protect its existing computer systems from virus threats in the cyberspace. Steve White, one of the company's executives, states that to achieve that end, an immune system like the human body's is needed.

*It's only the existence of an immune system that allows the human race to exist. Only an immune system in cyberspace will allow it to exist.<sup>90</sup>*





Pursuing this analogy between the computer and living things, researchers have begun producing protective programs that function like our own immune systems. They believe what we have learnt from epidemiology (the branch of science which studies contagious diseases) and immunology (which deals with the immune system) will be able to protect electronic programs from new threats in the same way that antibodies protect living organisms.

Computer viruses are clever self-replicating programs designed to infiltrate computers, multiply by copying themselves and damage or “hijack” the computers they enter. Indications that such viruses are present include a slowing down of the computer system, occasional mysterious damage to files, and sometimes, complete failure or “crashing” of the computer itself—much as with the various diseases that affect human beings.

To protect our computers against the menace of viruses, identification programs search every code in the computer's memory to find traces of viruses that have previously been identified and stored in the programs' memory. Computer viruses carry traces of the signature of the software writer that let them be recognized. When the computer's search program recognizes that telltale signature, it warns that the computer has been infected with a virus.

Even so, anti-virus programs can't offer complete protection for computers. Some programmers can write new viruses within a matter of a few days and again insert them into cyberspace through just one infected computer. That being the case, it's vital that anti-virus programs be constantly updated so that they have the information they need to recognize new viruses. New anti-virus programs need to be added constantly, therefore, to protect against the virus threat.

With the increasing spread of worldwide use of the Internet, these viruses have begun to spread very much faster and to inflict serious harm to infected computers. IBM researchers have found solutions by imitating natural examples. First of all, just like biological viruses in nature, artificial computer viruses use the host programming to multiply. Starting from that analogy, researchers investigated how the human immune system works to protect the body.

When it encounters a foreign organism, the body immediately begins to build antibodies that will recognize the invader and destroy it. The immune system doesn't need to analyze the whole of a cell that might result in a sickness. Once any preliminary infection has been suppressed, the body keeps a number of the appropriate antibodies in readiness, to respond immediately to any future recurrence. Thanks to these standby antibodies, there is no need to examine the entire infected cell. Similarly, existing anti-virus programs also contain an "antibody" that recognizes not the whole computer virus, but rather its signature.

As we have seen, the solutions to many problems in the technical arena that leave us floundering already exist in nature. Our immune system, of which every detail has been thought out and which functions perfectly, was ready to protect us before we were even born. It is Our Lord Who watches and protects all. In one verse it is revealed:

**My Lord is the Preserver of everything. (Qur'an, 11: 57)**

### **From the Eye to the Camera: the Technology of Sight**

The eyes of vertebrates resemble spheres with openings called pupils through which light enters. Behind the pupils are lenses. Light passes first through these lenses, then through the fluid that fills the eyeball, finally striking the retina. In the retina there are some 100 million cells known as rods and cones. The rod cells distinguish between light and dark, and the cones detect colors. All these cells turn the light falling onto them into electrical signals and send them to the brain via the optic nerve.

The eye regulates the intensity of the light entering it by means of the iris, surrounding the pupil. The iris is able to expand and contract, thanks to its tiny muscles. Similarly, the amount of light entering a camera is restricted by a device known as a diaphragm. In his book *Wild Technology*, Phil Gates describes how the camera is a very simple copy of the eye:

*Cameras are primitive, mechanical versions of vertebrate eyes. They are light-proof boxes equipped with a lens to focus an im-*

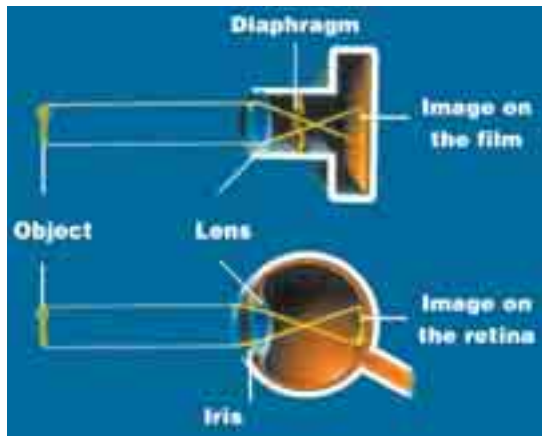

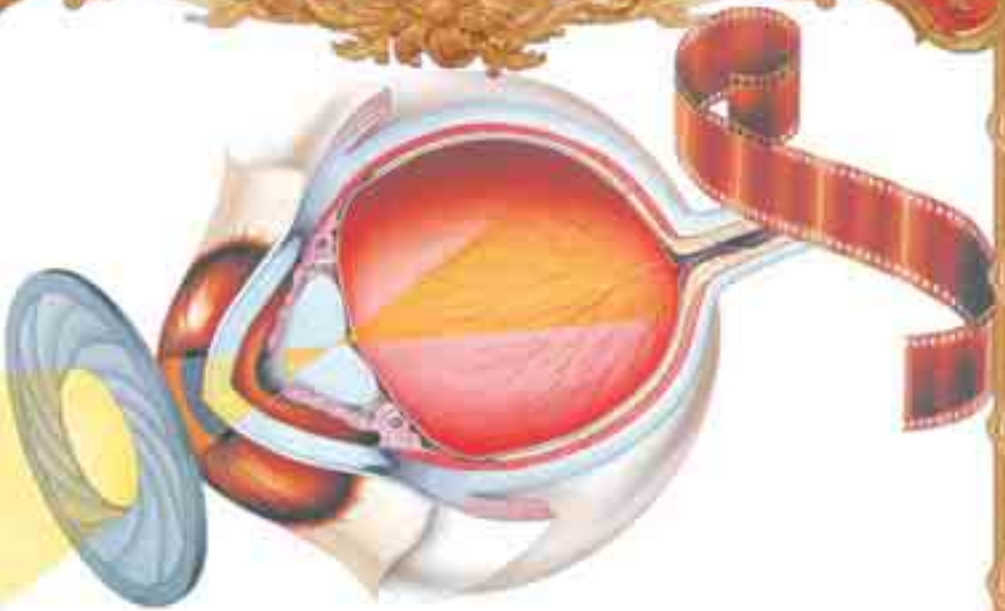

*age on film that is briefly exposed when a shutter is opened. In eyes the image is focused by changing the shape of the lens, but cameras are focused by changing the distance of the lens from the film.<sup>91</sup>*

### **Focusing**

This is the first step in taking a photograph. The same kind of focusing of an image is also necessary in order for it to fall clearly onto the sensitive retina in the eye. With cameras, this is done by hand or automatically in more sophisticated models. Microscopes and telescopes, used to see up close and far away, can also be focused, yet this process always involves a certain loss of time.

The human eye, on the other hand, performs this process constantly by itself, and very quickly. Furthermore, the method it employs is so superior that it cannot possibly be imitated. Thanks to the muscles around it, the lens sends the image onto the retina. Very flexible, this lens easily changes shape, sharpening the point on which light falls by expanding or contracting.

If the lens didn't do this automatically—for instance, if we had to

consciously focus on the object of our attention—then we'd have to make a constant effort to be able to see. Images in our sight would blur in and out of focus. We would require time to see anything properly and as a result, all of our actions would be slowed down.

Because God has made our eyes flawless, however, we experience none of these difficulties. When he wants to see anything, no one has to wrestle with setting his eyes' focus and make various optical calculations. In order to see an object clearly, it is sufficient to look at it. The rest of the process is handled automatically by the eye and the brain—moreover, it all takes place in the space of time it takes to wish to do it.

### Light Settings

A photograph taken in the daytime will be very clear, but not when the same film is used to take a picture of the night sky. Yet even though our eyes open and close in less than one-tenth of a second, we can see the

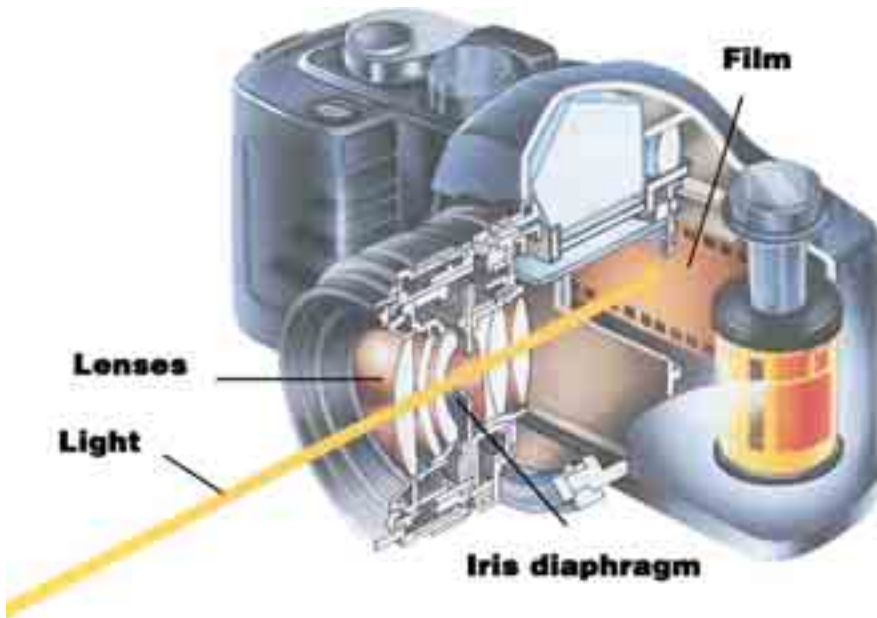

stars quite clearly, because our eyes automatically set themselves according to various intensities of light. Muscles around the pupil allow this to happen. If our surroundings are dark, these muscles expand, the pupil widens and more light is allowed into the eye. With plenty of light, the muscles contract, the pupil shrinks and less light is permitted to enter. That is why we enjoy clear vision both night and day.

### **A Window on a Colored World**

The eye “snaps” both a black-and-white picture and a colored one at the same time. These two pictures are later combined in the brain, where they take on a normal appearance, in much the same way as four-color photography combines black with red, yellow, and blue to produce a realistic full-color image.

The rod cells in the retina perceive objects in black and white, but in a detailed manner. The cone cells identify the colors. As a result, the signals received are analyzed, and our brains form a colored image of the outside world.



### **The Eye's Superior Technology**

Compared with the eye, cameras possess a very primitive structure. Visual images are many times more precise than those obtainable with even the most highly developed camera. As a result, images perceived by the eye are of much higher quality than those provided by any man-made equipment.

This whole idea can be better grasped if we examine the principles of a TV camera, which operates by transmitting numerous dots of light. During broadcast, a scanning procedure is applied, and the object before the camera is thus divided into a specific number of lines. A photocell lamp scans all the dots in each line consecutively, from left to right. Having finished scanning one line, it moves on to the next, and the process continues. The light values of each dot are analyzed, and the resulting signal is emitted. This photocell scans 625 or 819 lines in one-twenty fifth of a second. When one entire image is complete, a new one is transmitted. In this way the quantity of signals emitted is very high, all created at a dazzling speed.

The eye's mechanism is much more functional. One can clearly understand the astonishing perfection of its structure when one considers that it never needs to repair or replace any parts.



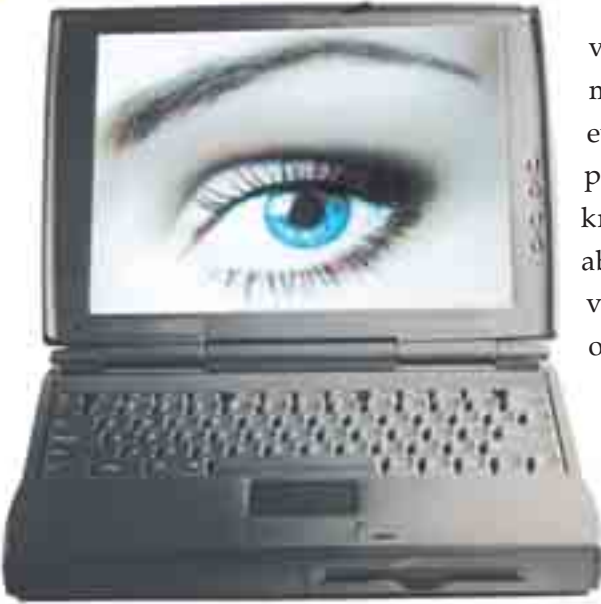

As medical science advances, the human eye's miraculous nature is being ever better understood. By applying to technology the knowledge we're acquiring about the eye, ever more advanced cameras and countless optical systems are being developed. But no matter how much technology advances, the electronic devices manufactured so far remain a primitive copy of the eye itself. No computer-supported camera or other

man-made gadget can rival the human eye.<sup>92</sup>

So how did this complex structure in the eye emerge?

It is undoubtedly impossible for any structure this complex to form itself by trial and error, over a long period of time. The eye's structure is such that it won't be able to work if even one component is lacking. No design can come about by chance, and the eye reveals a very clear and incomparable design. This leads us to the question of Who designed it. The only Originator of the design is God. The fact that such an organ has been given to us, allowing us to perceive everything round us in the best possible way, is a great reason for us to thank Him. As we are told in one verse of the Qur'an,

**Say: "It is He Who brought you into being and gave you hearing, sight and hearts. What little thanks you show!" (Qur'an, 67: 23)**



## Scientists' Attempt to Imitate the Eye

Amazed at the eye's functioning, and seeking to duplicate its superior features in the technological field, scientists have recently begun to examine more closely the flawless mechanisms of living things in nature. A number of studies in biomimetics have greatly accelerated progress in the technological arena.

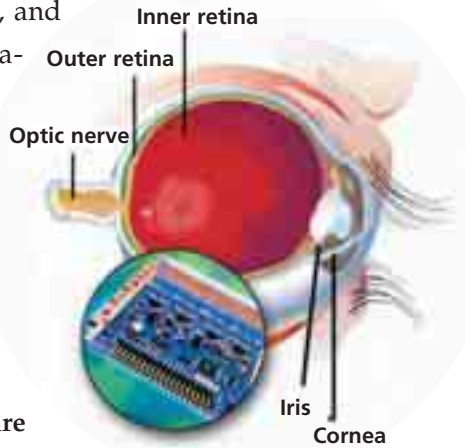

### Computer Circuitry Imitates Nature

The retinal cells in our eyes recognize and interpret light, then send this information to other cells to which they are connected. All these visual processes have inspired a new model for computers.

The retina, consisting of nerve cells tightly linked to one another, is not restricted to only perceiving light. Before signals from the retina are transmitted to the brain, they undergo a huge number of processes. For instance, cells that compose the retina process information to accentuate the edges of objects, called "edge extraction," boost the power of the electrical signal and carry out adjustments, depending on whether the ambient illumination is dark or bright. Yes, powerful modern computers are capable of carrying out similar functions, but the retina's neural network uses a relatively much smaller amount of energy.<sup>93</sup>

One research team, led by Carver Mead of the California Institute of Technology, is looking into the secrets that allow the retina to carry out all these processes so easily. Together with the Caltech biologist Misha Mahowald, Mead designed electronic circuits containing light receptors

like those in the eye, with a structure similar to the retina's neural network. Also as in the retina, these light receptors are connected to others, allowing the electronic circuit components to communicate with one another, just as retinal cells do.<sup>94</sup>



Carver Mead

Despite all these efforts, however, it's proved to be impossible to imitate the retinal network's circuitry, because of the vast number of individual cells in the living retina and the connections between them. Design engineers, therefore, are now trying to understand how the retina's neural network operates and are designing simpler circuits which, ideally, can perform similar functions.

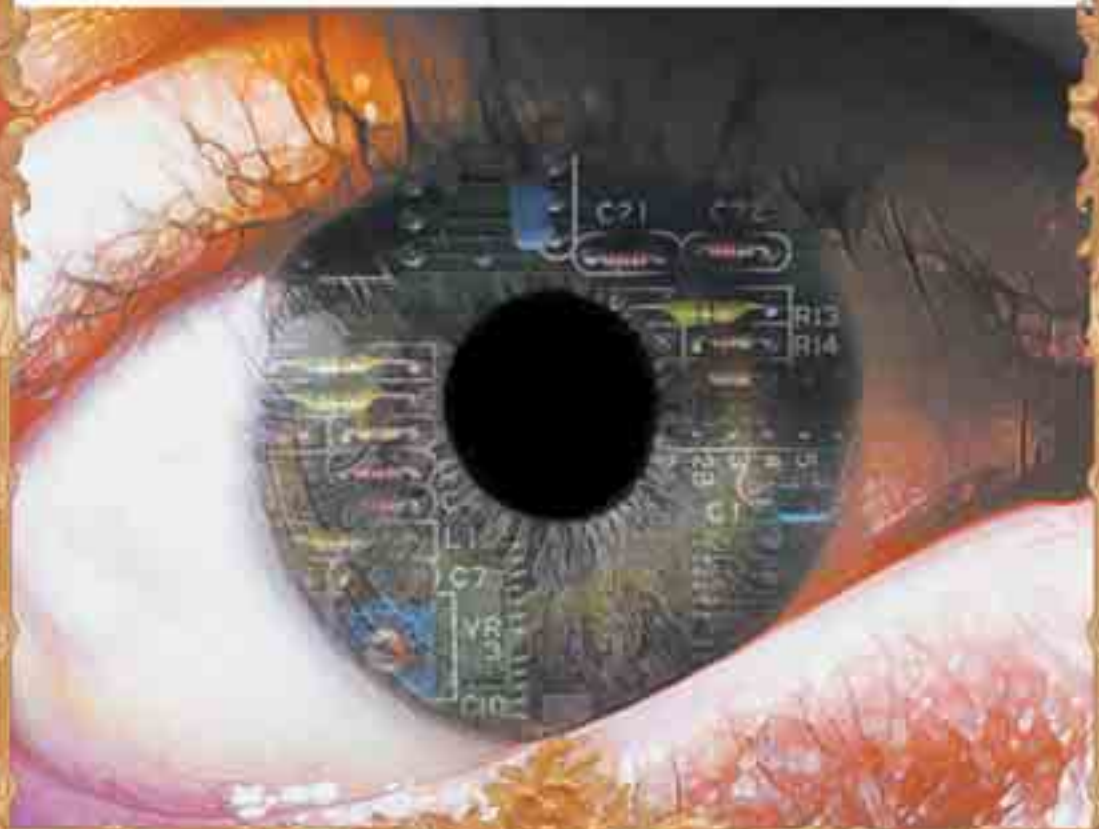

## The Fly's Ear Will Cause a Revolution in Hearing Devices

Researchers from Cornell University in Ithaca, N.Y., began studying hearing systems in nature in order to design more sensitive auditory equipment. As a result, they realized that the ear of *Ormia ochracea*, and its extraordinary design could lead to a revolution in hearing aids. The ear of this species of fly can identify a sound's direction in a most accurate manner. As an article of U.S. National Institute on Deafness and Other Communication Disorders describes it:

*Humans were considered the best creatures at locating sounds... Because humans have six or so inches between their right and left ears, the difference between what each ear hears is greater, making it easier to compute the location of the sound. But with its right ear only half a millimeter away from its left, Ormia has a much bigger challenge in telling the difference.<sup>95</sup>*

Identifying the direction of sounds is essential for *Ormia's* survival, because it must locate crickets as a source of food for its larvae. The fly deposits its eggs atop the cricket, and its larvae feed on the insect after they emerge.

*Ormia* has very sensitive ears designed to establish the location of a chirping cricket. It can pinpoint sounds exceptionally well.

For locating sounds, the human brain uses a similar method to that of *Ormia*. For this purpose, it's enough for sound to reach the closer ear first, then the more distant one. When a sound wave strikes the eardrum's membrane, it is converted into an electrical signal and immediately transmitted to the brain. The brain calculates the milliseconds of difference between the sound's reaching both ears and thus determines the direction it came from. The fly, whose brain is no larger than a pinhead, performs this calculation only



in 50 nanoseconds, 1,000 times faster than we can.<sup>96</sup>

Scientists are trying to use the exceptionally functional design of this small fly's ear in the manufacturing of hearing and listening devices under the brand name of ORMIA-FON. As we have shown, even the tiny fly possesses a superior structure and design that demolishes evolution's nonsensical theory of "coincidence." In the same way, this minute creature's every organ and feature display the infinite might and knowledge of our Creator.

It is impossible for such a tiny yet complex creature to be recreated even by skillful scientists working together and employing the most advanced technology, let alone through an imaginary "evolutionary" process.

Even this tiny fly constitutes a self-evident proof of God's superior creation.



**O Humanity! An example has been made, so listen to it carefully. Those whom you call upon besides God are not even able to create a single fly, even if they were to join together to do it. And if a fly steals something from them, they cannot get it back. How feeble are both the seeker and the sought! They do not measure God with His true measure. God is All-Strong, Almighty.**

**(Qur'an, 22: 73-74)**



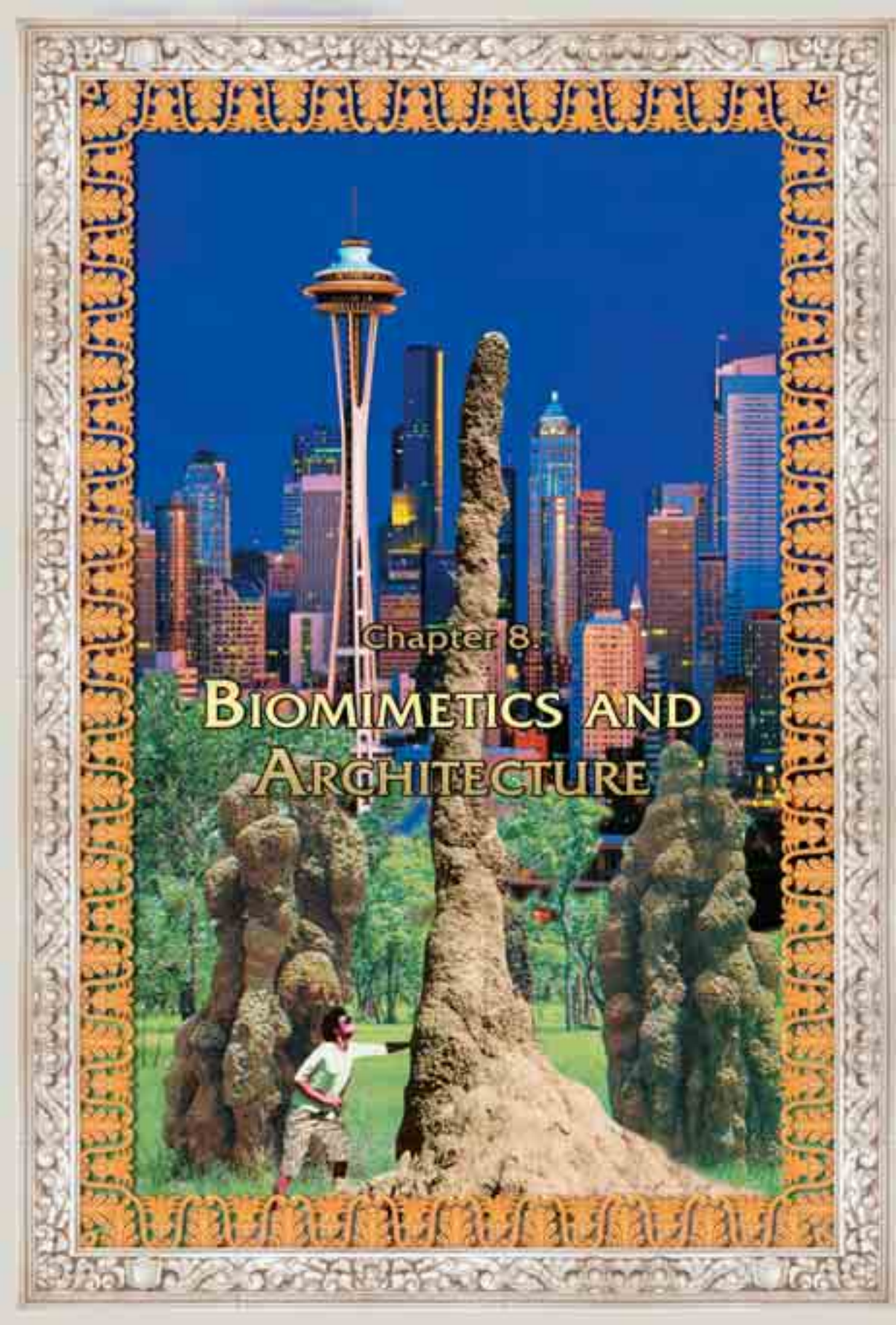

Chapter 8

# BIOMIMETICS AND ARCHITECTURE



ince the designs in nature are quite flawless, their inspirations are now frequently employed in architectural designs. All the features necessary in a structure, such as energy savings, beauty, functionality and durability have already been created in the natural world. No matter how many superior systems human beings may run across, their imitations can never be as good or practical as the originals.

In order to copy nature's designs and implement them in architectural design, a high level of engineering know-how is essential. Yet the living things in the natural world know nothing about load bearing or architectural principles. Nor do they have any opportunity of understanding them. All living things behave in the manner God inspires in them. In one verse, He reveals that all living things are under His control:

**... There is no creature He does not hold by the forelock...  
(Qur'an, 11: 56)**



Buckminster Fuller, an architect famous for using forms in nature in the structures he designed, said that the designs in nature make marvelous models. According to Fuller, what makes nature's dynamic, functional and light weight technology essential is "optimum efficiency." ("Invisible Architecture," Bonnie Goldstein DeVarco, <http://members.cruzio.com/~devarco/nature.htm>) The picture shows Fuller with a design inspired by the microscopic creatures known as radiolarians.



Architect Eugene Tsui is known for using the designs in nature in his structures. Tsui does not employ the right angles and straight lines we are accustomed to, but instead prefers the soft lines found in nature. Structures planned along these lines, he says, are better able to withstand the destructive effects of earthquakes, wind and water. (National Geographic Channel (Turkey), Animal Inventors, 25/11/2001)

### Oyster Shells—a Model for Light, Sturdy Roofs

The shells of mussels and oysters resemble wavy hair because of their irregularly shapes. This shape allows the shells, despite being very lightweight, to withstand enormous pressure. Architects have employed their structure as a model for designing various roofs and ceilings. For example, the roof of Canada's Royan Market was designed with the oyster shell in mind.<sup>97</sup>



An oyster shell and the Royan Market



The oyster shell's curved shape makes it especially resistant. Corrugated cardboard duplicates the curved lines found in oyster shells, making it stronger than ordinary, flat cardboard.



Harun Yahya

## The Munich Olympic Stadium and Dragonfly Wings

Dragonfly wings are one three-thousandth of a millimeter thick. Despite being so thin, however, they are very strong since they consist of up to 1,000 sections. Thanks to this compartmental structure the wings do not tear, and are able to withstand the pressure that forms during flight. The roof of the Munich Olympic Stadium was designed along the same principle.



The Munich Olympic Stadium

## From the Water Lily to the Crystal Palace

Built for the first World's Fair in London in 1851, the Crystal Palace was a technological marvel of glass and iron. Some 35 meters (108 feet) high and covering an area of approximately 7,500 square meters (18 acres), it featured more than 200,000 panes of glass, each 30 by 120 centimeters (12-by-49 inches) in size.

The Crystal Palace was designed by landscape designer Joseph Paxton, who drew inspiration from *Victoria amazonica*, a species of water lily. Despite its very fragile appearance, this lily possesses huge leaves that are strong enough for people to stand on.

When Paxton examined these leaves' undersides, he found they were supported by fibrous extensions like ribs. Each leaf has radial ribs stiffened by slender crossribs. Paxton thought these ribs could be duplicated as weight-bearing iron struts, and the leaves themselves as the glass panes. In this way, he succeeded in constructing a roof made of glass and iron, which was very light yet still very strong.<sup>98</sup>

The water lily begins growing in the mud at the bottom of Amazonian lakes, but in order to survive, it needs to reach the surface.



The structure of the water lily was used when building the Pan Am Terminal at New York's John F. Kennedy Airport.

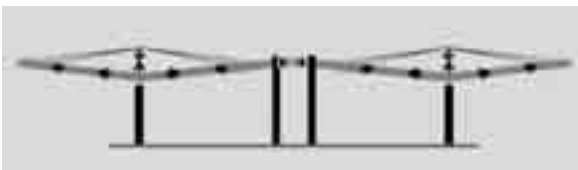

The diagram to the left shows how a roof designed along the lines of a water lily leaf distributes the load.

The Crystal Palace in London



When it comes to the surface of the water it stops growing, then starts forming thorn-tipped buds. In as little as a few hours, these buds open into enormous leaves up to two meters across. The more area they cover on the surface of the river, the more sunlight they can obtain with which to carry out photosynthesis.



Another thing the root of the water lily requires is oxygen, of which there is little in the muddy bottom where the plant is rooted. However, tubes running down the long stems of the leaves, which can reach as much as 11 meters (35 feet) in height, serve as channels that carry oxygen from the leaves down to the roots.<sup>99</sup>

As the seed starts to grow in the depths of the lake, how does it know that it will soon need light and oxygen, without which it can't survive, and that everything it requires is at the surface of the water? A plant that has only just begun to germinate is unaware that the water around has a surface up above, and knows nothing of the Sun or oxygen.

According to evolutionist logic, therefore, new water lilies should have drowned under several feet of water and become extinct long ago. Yet the fact is that these water lilies are still around today, in all their perfection.

Amazon lilies, after reaching the light and oxygen they need, curl their leaves upwards at the edges so that they do not fill with water and sink. These precautions may help them survive, but if the species is to

continue, they need some insects to carry their pollen to other lilies. In the Amazon, beetles have a special attraction to the color white and therefore, select this lily's flowers to land on. With the arrival of this six-legged guests, who will allow the Amazon lilies to survive down the generations, the petals close up, preventing the insects from escaping, while offering them large quantities of pollen. After holding them imprisoned for the whole night and throughout the next day, the flower then releases them, also changing color so that the beetles do not bring its own pollen back to it. The lily, formerly a shining white, now adorns the river in a dark pink.

No doubt that all these flawless, perfectly calculated, and consecutive steps are not the work of the lily itself, which has no foreknowledge or planning abilities, but flow from the infinite wisdom of God, its Creator. All the details summarized briefly here demonstrate that, like all things in the universe, God created them with all the necessary systems to ensure their survival.



**Left: Cross section of the water lily.**

**Below: The water lily's leaf and flower on the water's surface.**



## A Structure that Makes Bones More Resistant

Even today, the Eiffel Tower is accepted as a marvel of engineering, but the event that led to its design took place back to 40 years before its construction. This was a study in Zurich aimed at revealing "the anatomical structure of the thigh bone."

In the early 1850s, the anatomist Hermann von Meyer was studying the part of the thigh bone that inserts into the hip joint. The thigh bone head extends sideways into the hip socket, and bears the body's weight off-center. Von Meyer saw that the inside of the thigh bone, which is capable of withstanding a weight of



The Eiffel Tower was built with a structure similar to that of the thigh bone head. Thanks to this design, the tower acquired an unshakable structure that also solved the ventilation problem.

of one ton when in a vertical position, consists not of one single piece, but contains an orderly latticework of tiny ridges of bone known as trabeculae.

In 1866, when the Swiss engineer Karl Cullman visited von Meyer's laboratory, the anatomist von Meyer showed him a piece of bone he had been studying. Cullman realized that the bone's structure was designed to reduce the effects of weight load and pressure. The trabeculae were effectively a series of studs and braces arranged along the lines of force generated when standing. As a mathematician and engineer, Cullman translated these findings

Harun Yahya



The latticework, copied from bones, has become one of the basic elements employed in construction techniques today. It requires fewer materials, and makes for a building framework that's both strong and flexible.



Many architects and construction engineers duplicate the internal structure of bone, which increases its load-bearing capabilities and provides enormous strength. Roofs can be built to cover large areas thanks to the use of ribbed structures similar to those in bone.

into applicable theory and the model lead to the design of the Eiffel Tower.

As in the thigh bone, the Eiffel Tower's metal curves formed a lattice built from metal studs and braces. Thanks to this structure, the tower was easily able to stand up to the bending and shearing effects caused by the wind.<sup>100</sup>

A vibrant tropical garden scene framed by an ornate, golden-brown border. In the foreground, a stone bridge with a white railing spans a blue stream. To the left, a pavilion with a red roof and white pillars stands near a pool. The background is filled with lush greenery, including several tall palm trees and various shrubs. The sky is a clear, bright blue. The entire scene is set against a deep red background.

**Your deity is God alone, there is no deity but Him. He encompasses all things in His knowledge.**  
**((Qur'an, 20: 98))**



## The Radiolaria Design Used as a Model in Dome Design

Radiolaria and diatoms, organisms that live in the sea, are virtual catalogs of ideal solutions to architectural problems. In fact, these tiny creatures have inspired a great many large-scale architectural projects. The U.S. Pavilion at EXPO '76 in Montreal is just one example. The pavilion's dome was inspired by the radiolarians.<sup>101</sup>



## The Earthquake-Proof Design in Honeycombs

The construction of honeycombs offers a great many important advantages, including stability. As the bees in the hive give directions to one another in the so-called “waggle dance,” they set up vibrations that, in a structure of such small dimensions, can be equated to an earthquake. The walls of the comb absorb these potentially damaging vibrations. *Nature* magazine stated that architects could use this superior structure in designing earthquake-proof buildings. Included in the report was the following statement by Jurgen Tautz of the University of Wurzburg, in Germany:

*Vibrations in honeybee nests are like miniature earthquakes generated by the bees, so it's very interesting to see how the structure responds to it... Understanding the phase reversal could help architects predict which parts of a building will be especially vulnerable to earthquakes... They could then strengthen these areas, or even introduce weak spots into non-critical areas of buildings to absorb harmful vibrations.<sup>102</sup>*

As this all shows, the combs that bees construct with such flawless precision expertise are marvels of design. This structure within the comb thus paves the way for architects and scientists, giving them new ideas. It isn't chance that allows bees to construct their combs so perfectly, as evolutionists claim, but God, the Lord of infinite might and knowledge, Who gives them that ability.

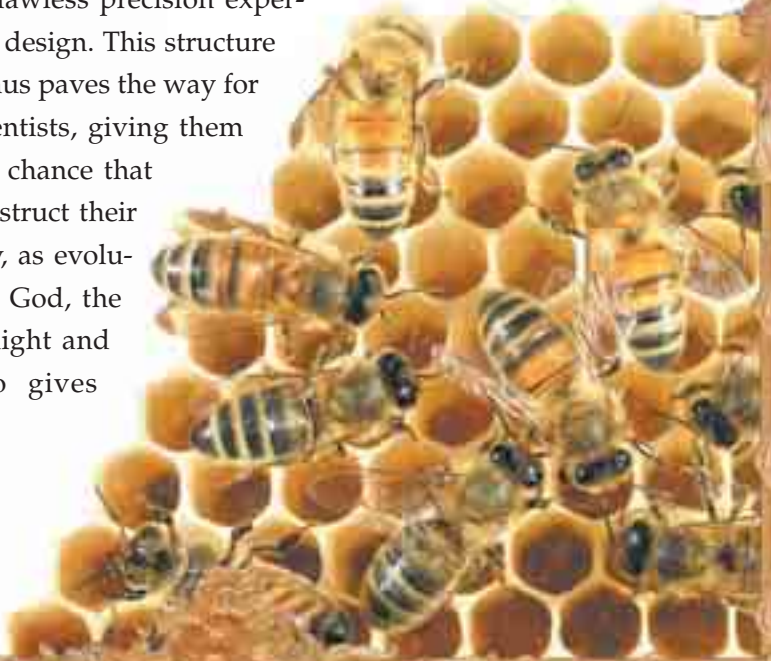

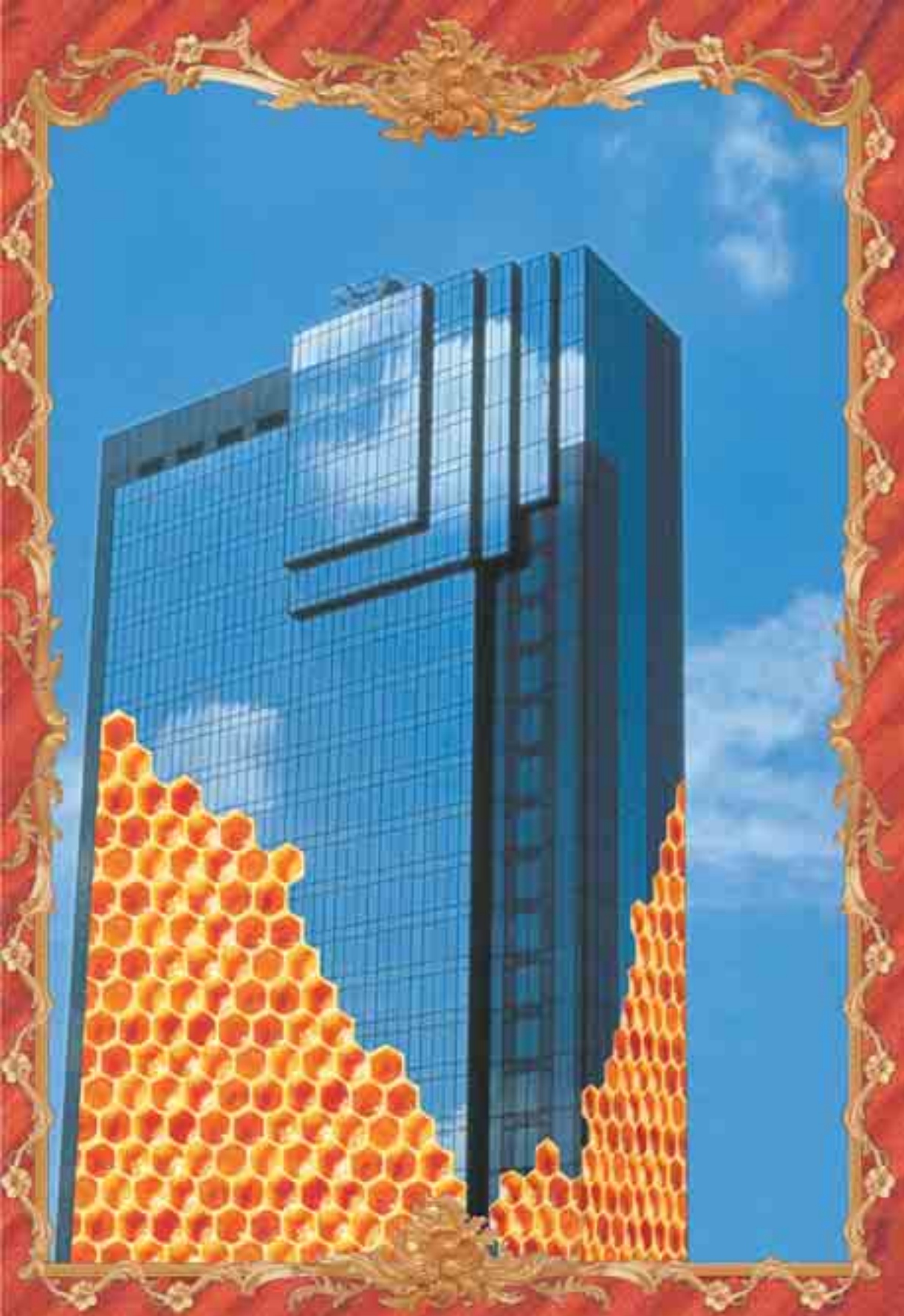

## Architectural Designs Drawn from Spider Webs

Some spiders spin webs that resemble a tarpaulin covering thrown over a bush. The web is borne by stretched threads attached to the edges of the bush. This load-bearing system lets the spider spread its web wide, while still making no concessions as to its strength.

This marvelous technique has been imitated by man in many structures to cover wide areas. Some of these include the Jeddah Airport's Pilgrim Terminal, the Munich Olympic Stadium, the Sydney National Athletic Stadium, zoos in Munich and Canada, Denver Airport in Colorado, and the Schlumberger Cambridge Research Centre building in England.

To learn these web-building techniques all by itself, any spider species would have to undergo a long period of engineering training. That, of course, is out of the question. Spiders, knowing nothing about load-bearing or architectural design, merely behave in the manner God inspires in them.

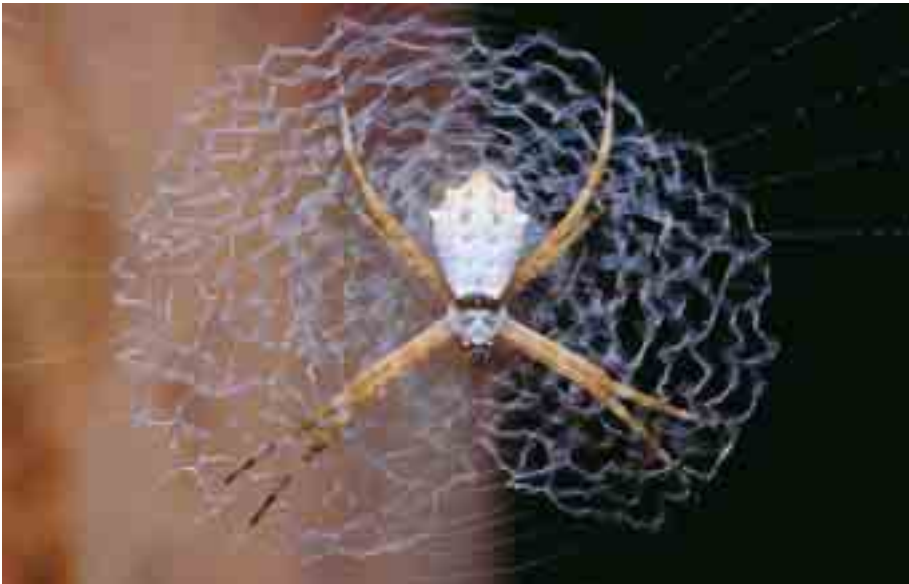



1. The Munich Olympic Stadium
2. Munich Zoo
3. Jeddah Airport
4. Denver's Airport
5. Sydney's National Athletic Stadium



Chapter 9.

# ROBOTS THAT IMITATE LIVING THINGS



ike areas contaminated with radioactivity and deep space, the depths of the sea are dangerous places for human beings. Improvements in electronics and computer technology have let us construct robots that can work in such places. Eventually, this discipline split away from electronics and mechanics to form a branch of science in its own right—robotics. These days, those who work with robotics have a new concept on their agenda: biomimetic robotics.

Scientists and engineers engaged in robotics now believe that designing robots for a particular task isn't very practical. They consider it easier and makes better sense to build robots that imitate the features and abilities of living things, indigenous to the environments where these robots are to be employed. For desert exploration, for example, they'll create a biomimetic robot resembling a scorpion or an ant. A book called *Neurotechnology for Biomimetic Robots* contains the following information on this subject:

*Biomimetic robots differ from traditional robots in that they are agile, relatively cheap, and able to deal with real-world environments. The engineering of these robots requires a thorough understanding of the biological systems on which they are based, at both the biomechanical and physiological levels.*

*... The ultimate goal is to develop a truly autonomous robot, one able to navigate and interact with its environment solely on the basis of sensory feedback without prompting from a human operator.<sup>103</sup>*





What led scientists to imitate living things was their flawless physical designs. Engineer Hans J. Schneebeli, designer of the robotic device known as the Karlsruhe Hand, stated that the more he worked on robotic hands, the more he admired the human hand. He added that they still need plenty of time to duplicate even a few of the many tasks that a human hand can accomplish.<sup>104</sup>



On occasion, scientists from such different disciplines as computer technology, mechanics, electronics, mathematics, physics, chemistry and biology must join forces to replicate just one feature of a living creature. Yet evolutionist thinking still maintains that the extraordinarily complex structures of living things could have come about unplanned, of their own accord.



## **Robotics Is Imitating Snakes to Overcome the Problem of Balance**

For those engaged in robotics, one of the problems they encounter most frequently is maintaining equilibrium. Even robots equipped with the very latest technology can lose their balance when walking. A three-year-old child can manage to regain balance with no difficulty, yet robots lacking this ability are, of necessity, stationary and of very little use. In fact, one robot that NASA prepared for duty on the planet Mars couldn't be used at all, for that very reason. After that, robot experts abandoned attempts to build a balance-establishing mechanism and instead looked to a creature that never loses its balance—the snake.

Unlike other vertebrates, snakes lack a hard spine and limbs, and have been created in such a way as to enter cracks and crevices. They can expand and contract the diameter of their bodies, can cling to branches and glide over rocks. Snakes' properties inspired for a new robotic, interplanetary probe developed by NASA's Ames Research Center which they





called the "snakebot." This robot thus was designed to be in a constant state of balance, without ever getting caught up by obstacles.<sup>105</sup>

### **The Balance Center in the Inner Ear Astounds Robotics Experts**

The inner ear performs a vital role in our system of balance, controlling our whole body at every moment and allows us to perform the delicate adjustments required by a tightrope walker, for example.

This center of balance in the inner ear, known as the labyrinth, consists of three small semicircular canals. They are 6.5 mm (0.26 in) in diameter and, in cross-section, the hollow space inside them measures 0.4 mm (0.016 in). The three are laid out in orthogonal planes. An individual canal senses rotations in one of three orthogonal directions. Thus the three canals combine their results and give the ability to sense rotations in any direction in three-dimensional space.

Inside each of these three canals is a viscous fluid. At one end of the

tube is a gelatinous cap (cupula), which sits on a bulged area (crista) covered with sensory hair cells. When we turn our heads, walk, or make any movement, the fluid within these canals lags behind because of inertia. The fluid pushes against the cupula, deflecting it. This deflection is measured by the hair cells in the crista as the hairs' vibration alters the ion balance in the cells connected to them, producing electrical signals.

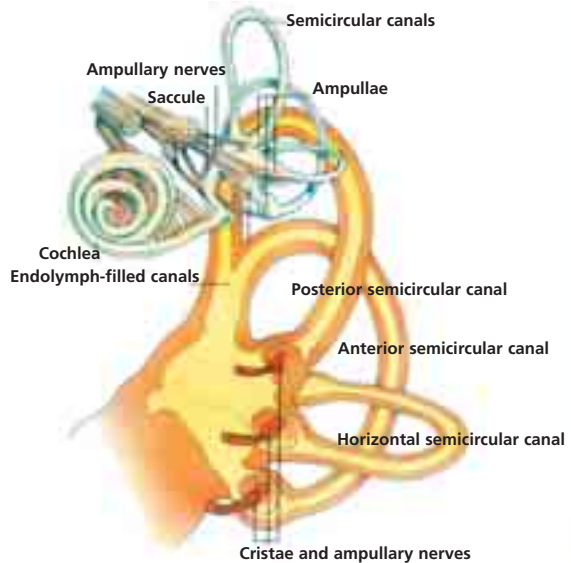

These signals produced in the inner ear are transmitted by means of nerves to the cerebellum at the back of our brain. These transmitter nerves from the labyrinth to the cerebellum have been shown to contain 20,000 nerve fibers.

The cerebellum interprets this information from the labyrinth, but in order to maintain balance, it also needs other information. Therefore, the cerebellum receives constant information from the eyes and from muscles throughout the body, rapidly analyzing all this information and calculating the body's position relative to gravity. Then, based on these instant calculations, it notifies the muscles via the nerves of the exact movements they should make to maintain balance.

These extraordinary processes occur in less than 1/100th of a second. We are able to walk, run, ride a bicycle, and play sports without even being aware all this is going on. Yet if we were to put down on paper all the calculations going on in our bodies at any one instant, the formulae



**Balance is brought about by a most extraordinarily complicated system, since the human body is in constant motion. That means the brain must constantly recalculate the body's center of gravity, and send instructions to the muscles in light of this.**

would fill thousands of pages.

Totally flawless, our balance system functions by means of several very complex mechanisms, all interconnected and working together. Modern science and technology have yet to unravel all the details of their operative principles, let alone imitate them.

It is of course impossible for such a complex design to have come about by chance, as evolution theory would have us believe. Every design reveals the existence of a conscious designer. Our balance system's superior design is one more proof of the existence of God, Who created that system so impeccably, and of His infinite wisdom.

In the face of this realization, man's responsibility is to give thanks to God, Who gave him such a structure.

### **A Robot Scorpion Able to Withstand Harsh Desert Conditions**

In the United States, Defense Advanced Research Projects Agency (DARPA) is working to develop a robot scorpion. The reason the project selected a scorpion as its model is that the robot was to operate in the desert. Scorpions have been able to survive harsh desert conditions ever since their creation. But another reason why DARPA selected a scorpion was that along with being able to move over tough terrain very easily, its reflexes are much simpler than those of mammals—and can be imitated.<sup>106</sup>

Before developing their robot, the researchers spent a long time observing the movements of live scorpions using high-speed cameras, and analyzed the video data.<sup>107</sup> Later, the coordination and organization of the scorpion's legs were used as a starting point for the model's creation.



DARPA's objective is to have its 50 cm (20 in) robot scorpion reach a target 40 km (25 miles) away in the desert and then return—entirely on its own, without receiving any directions.<sup>108</sup>

Designed by Frank Kirchner and Alan Rudolph at Northeastern University in Boston, the robot has no ability to “think through” complex problems. Upon encountering a difficulty, it merely relies on its reflexes. This allows it to overcome any obstacles that might impede its progress—a rock, for example. At the front, the robot has two ultrasonic sensors. Should it encounter an obstacle more than half its own height, it will try going around it. If the detector on the left identifies an obstacle, it will turn to the right. The robot can be asked to go to a specific region and, with a camera in its tail, send back to base images of the location.

The U.S. Army was greatly impressed by the trials held in Arizona.

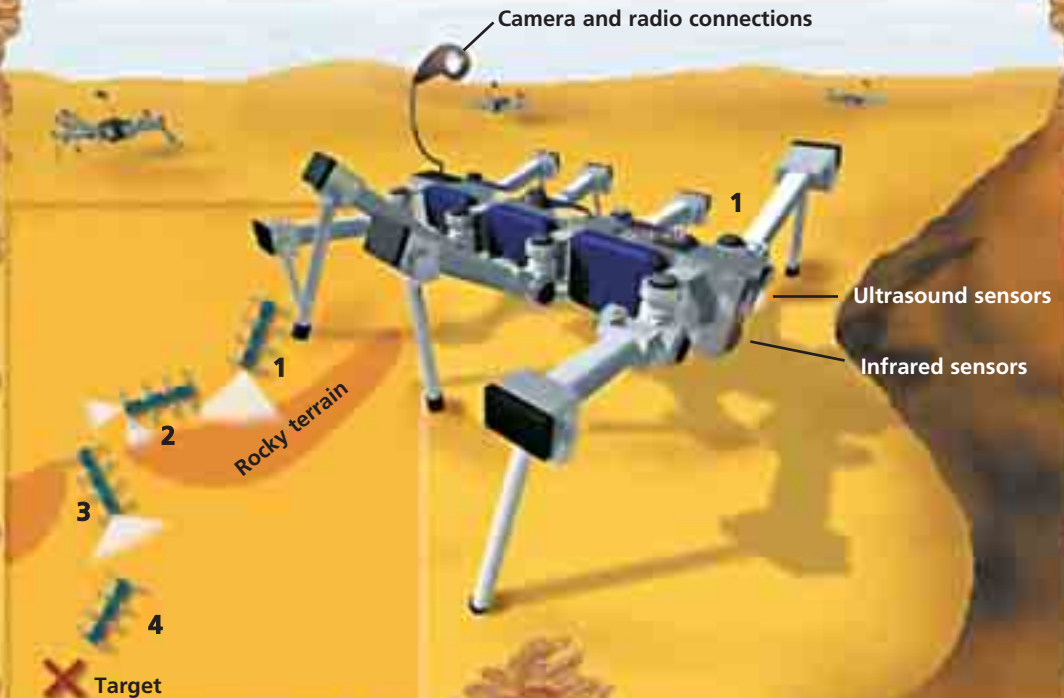

The scorpion robot, built using advanced technology, possesses a complex structure. Even though a great many scientists and engineers worked on this robot, it can only travel towards a pre-established target.

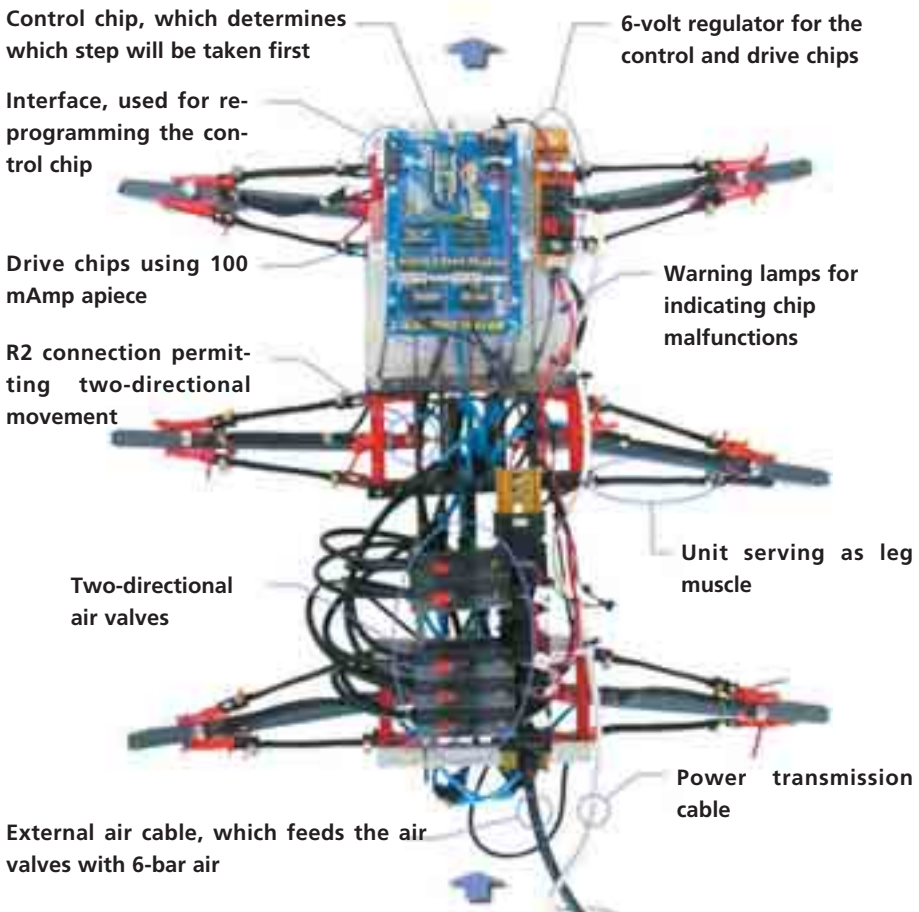

1. When the robot scorpion encounters a rock, first it scans it with ultrasound to decide whether it's too high to climb.
2. The robot moves away from the obstacle and goes around it, looking for a gap with one sensor and looking forward with the other.
3. On finding a gap, it determines whether it is wide enough to pass through.
4. Once it moves through the gap, the scorpion moves on towards its target.

It is hoped that the robot's ability to find its way to a target are could be particularly useful in cluttered battlefields such as towns.<sup>109</sup>

### **Just Like a Real Lobster, This Robot Will Identify Water Currents**

Even fully-equipped human divers have difficulty in moving through turbulent and murky waters, crawling along the bottom where it may be rough, sandy or covered with algae. Lobsters can, and very easily too. But so far, no robot made for use on the sea bed has been successful in such environments.





Joseph Ayers, Director of the Marine Science Center at Northeastern University in Boston is leading a project to develop a robot that imitates the lobster. As he describes it, the project's "technical goal is to capture the performance advantages that the animal systems hold in the target environment."<sup>110</sup>

They expect to use this "robo-lobster" in finding and disarming mines. Ayers says the robot will be ideally suited to this kind of work:

*... the sequence of behavioral acts that a lobster performs when it searches for food is exactly what one would want a robot to perform to find and neutralize underwater mines.*<sup>111</sup>

Lobsters' shape helps them resist tumbling or moving in fast-moving water. They are able to proceed in the direction they want under the most difficult conditions, even over very rough terrain. In the same way, the robo-lobster will use its tail and claws for stability.

On the robot, micro-electro-mechanical sensors (MEMS) imitate the lobster's sensory organs. Equipped with water current sensors and antennae, the robot can adapt its movements to the currents of the water around it. A live lobster uses hairs to determine the direction of currents,



and the robot lobster's electro-mechanical sensors are intended to do the same thing.<sup>112</sup>

### The Lobster's Technique for Identifying Scents

Underwater creatures such as crabs and lobsters use their sense of smell to find food, mates or to flee from predators. One study carried out by researchers from the Universities of California at Berkeley and Stanford revealed how lobsters smell the world around them.

Lobsters possess a very sensitive sense of smell, whose features will open up new horizons for robot engineers trying to build new odor sensors. Mimi A. R. Koehl, a professor of integrative biology in the College of Letters & Science at University of California, Berkeley, says:

*If you want to build unmanned vehicles or robots to go into toxic sites where you do not want to send a scuba diver, and if you want those robots to locate something by smell, you need to design noses or olfactory antennae for them.<sup>113</sup>*

Lobsters and other crustaceans smell by flicking a pair of antennules toward the source of the odor, so that the chemosensory hairs on the ends of the antennules come into contact with the water-borne odor molecules. The spiny lobster *Panulirus argus*, which lives in the Caribbean Sea, has



antennules 30 cm (3 to 4 inches) in length. On the outer edge of one of the split ends of its antennules are hairs resembling a brush—a region particularly sensitive to chemicals.

A group of researchers led by

Professor Koehl made a mechanical lobster that flicked its antennules in the same way. Tests and observations of this robot, dubbed Rasta Lobsta, were performed to study in detail the technique that lobsters employ in order to smell.

When the lobster wants to smell something, during the downstroke, it pushes the antennule through the water fast enough for the water bearing the odor to

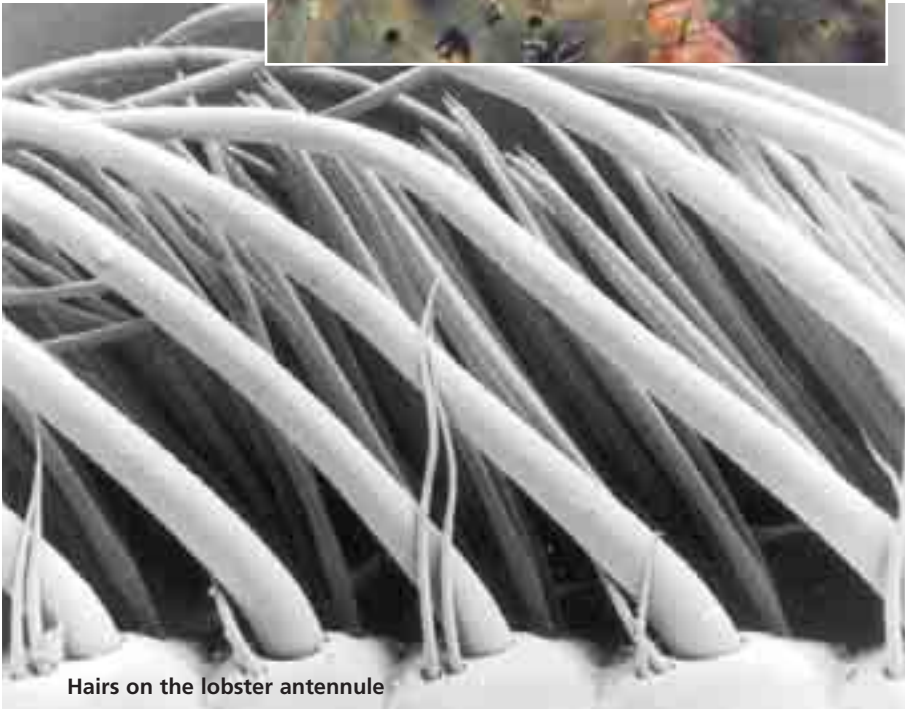

Hairs on the lobster antennule

penetrate into the brush of sensory hairs. On the return stroke, however, it sweeps more slowly, so the water is unable to move between the hairs and the odor plume that penetrated between the hairs during the downstroke are trapped until the next rapid downstroke.

The antennules move forward and back at the ideal speed for the lobster to be able to smell. Tests have shown that if the antennules moved more slowly, the water would not flow between the hairs, reducing the crustacean's ability to smell. Therefore, it uses its antennules in such a manner that it's able to preserve and capture even small differences in odor concentration in a plume.<sup>114</sup>

### **Structure of Worm Muscles Lead the Way to New Mechanical Systems**

The skin covering a worm's cylindrical body consists of fibers that are wound in a crossed helical form around and along the body—a most impressive design. The contraction of muscles in the body wall leads to an increase in the internal pressure, and the worm is able to change shape as the fibers in the skin allow it to go from short and fat to long and thin. This is the basis of how worms move.

This matchless mechanical system is presently inspiring new projects at Reading University's Centre for Biomimetics. In one experiment, cylinders of various fiber angles were arranged along the lines of the worm's anatomy. The plan is to fill these cylinders with a water-absorbent poly-



mer gel. Water causes this gel to expand. In this way, chemical energy is converted to mechanical energy in just the right place, and the resulting pressure will be contained safely inside the helically-wound bag. Once the swelling and contracting of the polymer gel is controlled, it is hoped that the resulting system will operate like an artificial muscle.<sup>115</sup>

Every living thing that man takes as a model, and every system in it, is a sign of God for those who believe. This truth is expressed in a verse:

**And in your creation and all the creatures He has spread about there are signs for people with certainty. (Qur'an, 45: 4)**



Changing shape, expanding and contracting by the use of pressure, is frequently used in nature.

The worm, octopus, starfish and anemone are some of the best examples; yet shape-changing is found much less frequently in technological equipment. In those few examples that do exist,

hydraulic pressure is employed. In lifts, for example, hydraulic liquid is pumped into a thin cylinder to raise heavy objects. To lower the lift, the cylinder is emptied again.

Starfish also use hydraulic pressure to move. Along the undersides of its arms, the echinoderm possesses tube-like feet, attached to an internal, fluid-filled tubing system. When its muscles contract the tubes, the resulting hydraulic pressure sends fluid to the feet. Using its muscles, the starfish uses hydraulic power to set up a wave motion in its feet, moving forward and back and allowing the starfish to progress in one direction.

## The Gecko's Feet Open New Technological Horizons

These small lizards are able to run very fast up walls and walk around clinging to the ceiling, very comfortably. Until recently, we didn't understand how it could be possible for any vertebrate animal to climb walls like the cartoon and film hero Spiderman. Now, years of research have finally uncovered



the secret on which their extraordinary ability depends. Little steps by the gecko have led to enormous discoveries with tremendous implications, particularly for robot designers. A few can be summarized as follows:

- Researchers in California believe that the lizard's "sticky" toes can help in developing a dry, and self-cleaning adhesive.<sup>116</sup>
- Geckos' feet generate an adhesive force 600 times greater than that of friction. Gecko-like robots could climb up the walls of burning build-





ings to rescue those inside. Dry adhesives could be of great benefits in smaller devices, such as in medical applications and computer architecture.<sup>117</sup>

- Their legs act like springs, responding automatically when they touch a surface. This is a particularly appropriate feature for robots, which have no brain. Geckos' feet never lose their effectiveness, no matter how much they are used; they are self-cleaning and they also work in a vacuum or underwater.<sup>118</sup>

- A dry adhesive could help hold slick body parts in place during nanosurgery.<sup>119</sup>

- Such an adhesive could keep car tires stuck to the road.<sup>120</sup>

- Gecko-like robots could be used to repair cracks in ships, bridges and piers, and in the regular maintenance of satellites.<sup>121</sup>

- Robots modeled after the geckos' feet could be used to wash windows, clean floors, and ceilings. Not only will they be able to climb up flat vertical surfaces, but overcome any obstacles they meet on the way.<sup>122</sup>

Chapter 10.

# TECHNOLOGY IN NATURE







reating technology—all the manufacturing methods and equipment used in a particular branch of industry—is no easy matter, because so many components need to be brought together. In order to produce technology in any given area, first of all we need to possess information. Next, the scientists and technical personnel who are to use this information must be added to the equation. These personnel need the right materials and the facilities in which to make use of them. For all these reasons, producing technology is a difficult business. Indeed, the history of those advances we describe as “technological” is by no means a long one. Even today, though many countries enjoy technology, very few of them actually produce it.

As scientific circles have noted, most of the technological products emerging as the result of investment, information and research have their “originals” and counterparts in nature.

Phil Gates, a well-known scientist and author of the book *Wild Technology*, expresses this in the following terms:

*Many of our best inventions are copied from, or already in use by, other living things. We have only discovered a tiny fraction of the vast numbers of living organisms that share our planet. Somewhere, amongst the millions of organisms that remain undiscovered, there are natural inventions that could improve our lives. They could provide new medicines, building materials, ways of controlling pests and dealing with pollution.*<sup>123</sup>



Every niche of our surroundings—from the sky to the land to the depths of the oceans—are full of countless “technological” marvels, each of them a product of creation. Even the simplest industrial product has a designer and place where it was manufactured. That being so, it would be obviously irrational to claim that living things, possessing systems incomparably superior to huge factories with their state-of-the-art machinery, could have arisen through chance, by themselves, as a result of natural conditions.

Every living thing possesses a superior, perfect design that emerged flawless and complete from the very day of its creation, because God is He Who creates flawlessly.

In this chapter we’ll examine some marvels of creation and compare them to present-day technology. We should regard these examples as food for thought, as God instructs us in the Qur’an, **“An instruction and a reminder for every penitent human being.”** (Qur’an, 50: 8)

### Light Sensors in Plants

Some species of plants are acutely sensitive to changes in light intensity. When night falls, they close up their petals. Some flowering plants even do this in cloudy weather, in order—scientists believe—to protect



Some flowers, sensitive to light, close their petals when it grows dark and keep them closed until dawn. Others keep their flowers facing the sun throughout the day.

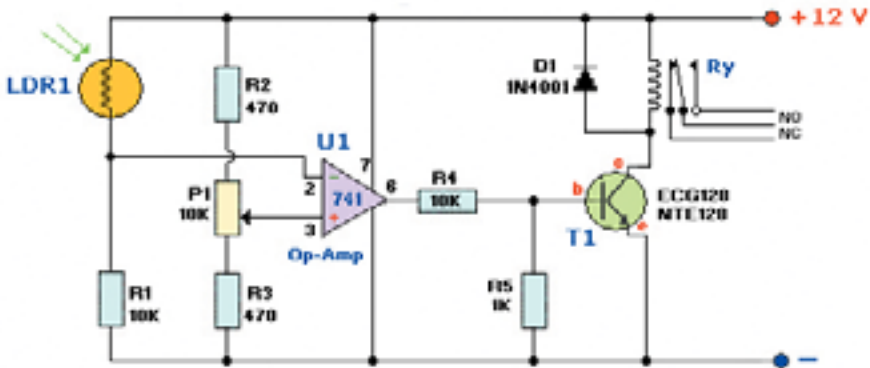

Above: In a light sensor, the electrical circuit consists of a great many parts. If just one is removed or only one connection altered, the circuit fails to work. The light sensors in plants possess a feature similar to this circuit: The slightest deficiency in the system will make the sensor totally useless.

their pollen from dew and approaching rain. We humans also use sensors that detect light intensity changes, and use them in lamps that go on when it gets dark at night and turn themselves off at dawn.<sup>124</sup>

### The Eider Duck and Its Insulation System

Our bodies generate heat energy by digesting the food we've eaten during the day. The best way to prevent the loss of this warmth is to keep it from leaving our bodies too soon. That is why we wear varying layers of clothing, depending on the weather. Warm air, trapped between the layers, is unable to reach outside. Preventing energy loss in this way is known as insulation.

The eider duck employs the exact same method. Like many birds, its feathers enable it to fly



and also keep it warm. It uses its soft and fluffy chest feathers in building its nest. This down protects the eggs and the emerging featherless chicks from the cold air. Since the eider's feathers retain warm air, they exemplify the very best form of natural insulation.<sup>125</sup>



Modern mountain climbers keep their bodies warm by wearing special costumes filled with feathers with high heat-retaining properties, similar to those of eider feathers.

### Fiber Optic Technology in Living Creatures

Fiber optics are transparent glass cables capable of transmitting light. Since optical fibers can be easily bent and twisted, they can “pipe” light into even the most inaccessible locations. Fiber optic cables also possess the advantage of being able to carry coded messages loaded onto them, much better than other cables can.

The polar bear's fur is very similar to an optical fiber, carrying the rays of the faint polar sun directly to the animal's body. Since the fur possesses fiber optic capabilities, the sun's rays make direct contact with the

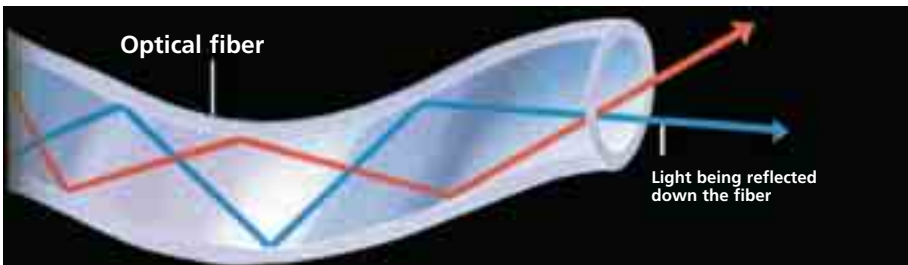

bear's skin. So great is its fur's capacity to transmit light that despite the harsh polar climate, the animal's skin turns dark, as if sunburned. The light, converted into heat and absorbed, helps warm the bear's body. Thanks to its fur's unique feature, the bear is able to keep its body warm even under the freezing polar conditions.<sup>126</sup>



Bears' fur is not their only feature that we can learn from. They can spend up to six months a year in hibernation, doing so by putting their excretory systems on hold and without suffering toxic buildups in their blood. Discovering how they do this will help in the fight against diabetes.<sup>127</sup>



The polar bear isn't the only living thing possessing fiber optic technology. Leaves of the *Fenestraria* plant, which lives in the deserts of South Africa, are nearly entirely buried in the sand. This protects *Fenestraria* from water loss and grazing animals. The tip of every leaf is transparent: Light enters here and can travel down the leaf. (Phil Gates, *Wild Technology*, 67.)

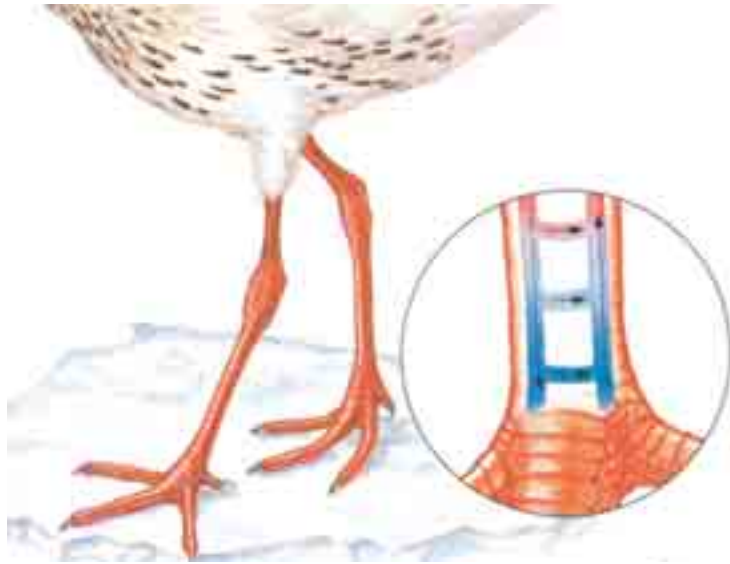

### Arctic Birds Using Counter-Current Heat Exchangers

In the coldest climates, local birds generally have their feet either in cold water or standing on ice. Yet there is no question of them ever freezing. All of them possess circulatory systems that reduce heat loss to a minimum. In these birds, heated and chilled blood circulate in different blood vessels, but these vessels run close together, however. In this way, warm blood flowing to the extremities downwards warms the cold blood circulating upwards. This also reduces the shock of cold blood returning to the body from the feet. This natural heat exchange mechanism, known as counter-current, is the same as that used in various machines.<sup>128</sup>

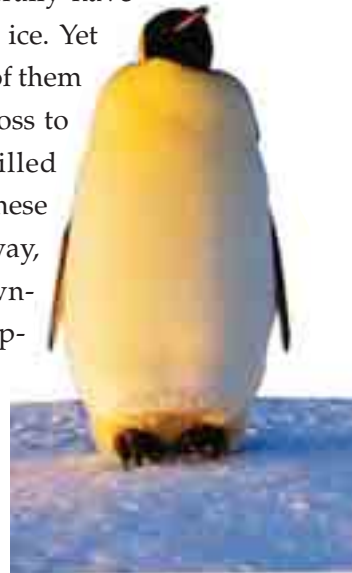

In these counter-current heat exchangers, as engineers refer them, two fluids (liquid or gas) flow in opposite directions in two separate but contiguous channels. If the fluid in one channel is warmer than in the other, heat passes from the warm fluid to the colder one.

### Can Plants Use an Electrical Switch?

The carnivorous Venus flytrap catches insects that land on its hinged trap and trigger the hairs on it. These hairs act like electrical switches. The instant one is touched, it gives off electrical signals that change the water balance in the plant's cells, and trigger the flow of water out of cells along the leaf midrib, closing the trap.<sup>129</sup>

The switches controlling the flow of current in electrical circuits operate in much the same way. When the switch is turned off, electric current cannot flow. As soon as it is turned on and the circuit is completed, however, electric current begins to flow along the wire once again. Similarly, animals and plants use a great many biological switches to initiate or halt the flow of electrical signals to the relevant parts of their bodies.<sup>130</sup>

The Venus flytrap's cir-

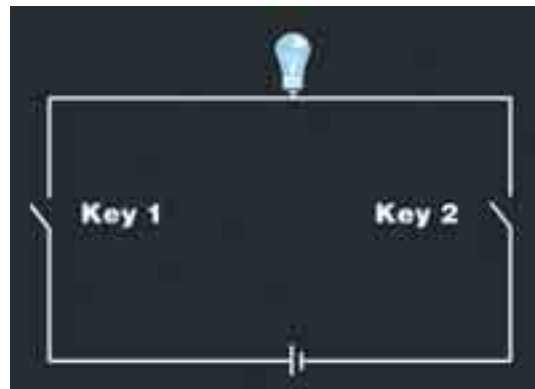

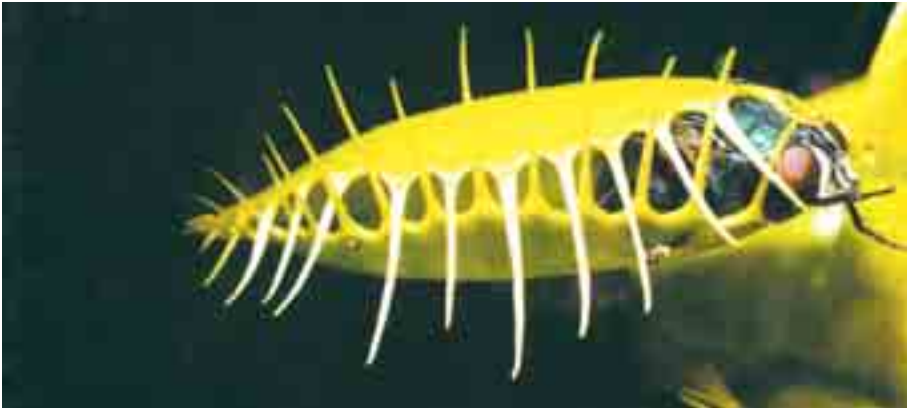

cuit actually works like two electrical switches connected together in series. Two hairs must be stimulated before the trap to close.<sup>131</sup> This precaution prevents unnecessary closing triggered by such phenomena as raindrops.

Of course, the Venus fly-trap knows nothing about electric current or the switches that let these currents flow. Nor is it possible for the plant to receive any kind of training in these areas. That being so, how does it come by this knowledge, which even a human being can't learn without special instruction, and how is it able to employ it so flawlessly? God, the Ruler of all, teaches the plants what to do. The Venus flytrap acts under His inspiration.

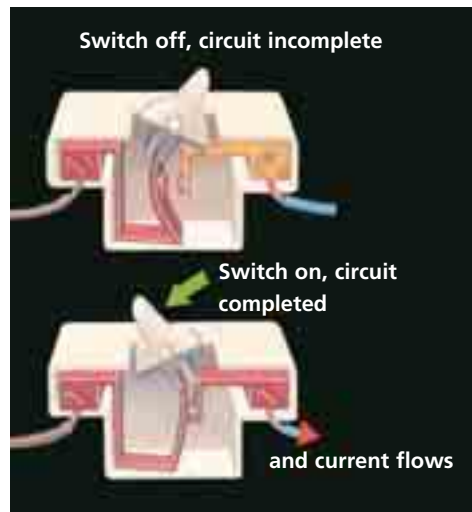





## The snail's drilling system is even able to rasp holes in rocks.

The snail's tongue, called a radula, resembles a large-toothed file. Thanks to this design, the mollusk is able to rasp holes in leaves and pick up algae on rocks.

Teeth on the radula are so hard that some desert snails are even able to make holes in rock. (Phil Gates, *Wild Technology*, 45.)

The giant excavators humans use to dig tunnels perform a similar function to the radula. However, the tips of these machines' drills wear out and have to be frequently replaced.



## If Nerve Cells Lacked Insulation

Nerve fibers carry messages from the brain to the muscles and other organs, and from there, messages back to the brain. The fibers are coated with a special, fatty substance known as myelin that works just like the plastic insulation around an electric cable. Were it not present, then the electrical signals would leak away into the surrounding tissues, either garbling the message or damaging the body.<sup>132</sup>

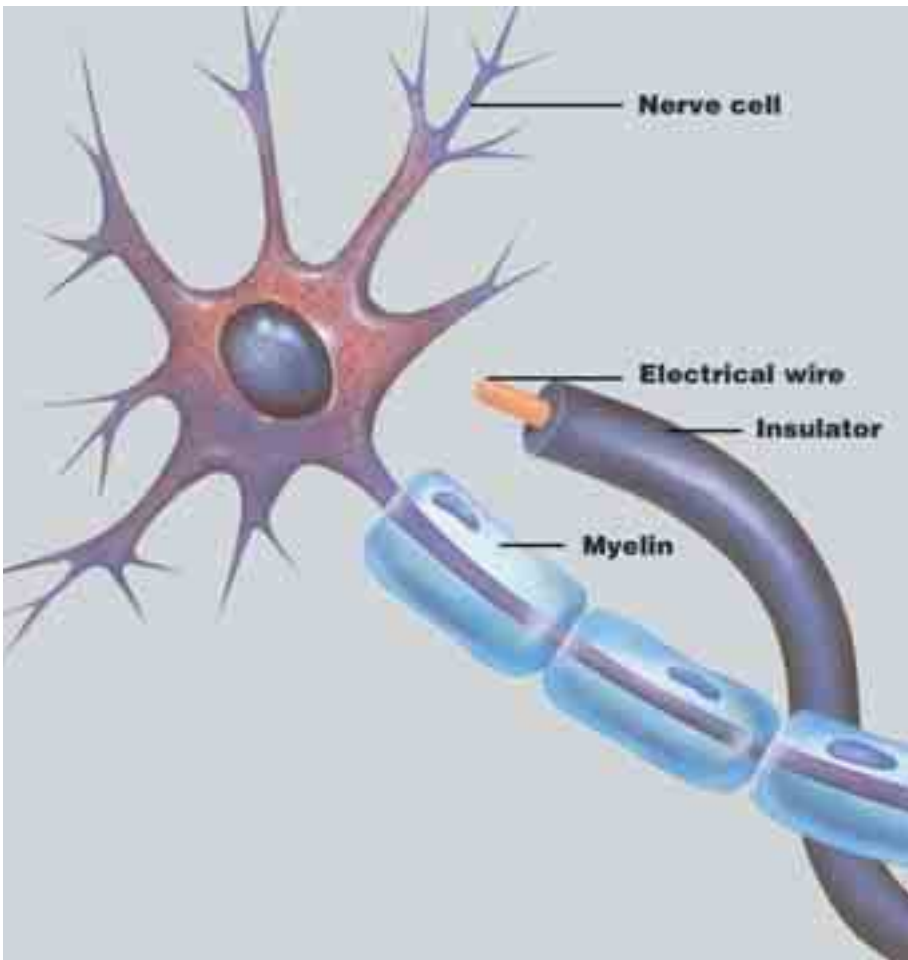

Electric cables are designed to protect from injury those who touch them and also to avoid any loss of power due to electricity leakage. Tough and durable plastics are used for this purpose.

### **Prairie Dogs' Ventilation Technology**

Many animals build underground shelters that require special features to defend them from predators.

In such shelters, the tunnels need to be at a specific distance from the surface and parallel to the ground, or else they may easily be flooded. If the tunnels are dug at a sharp angle, that poses a risk of collapse. Another problem in tunnel construction is meeting the need for air and ventilation.

Prairie dogs are social animals, living in large groups in burrows they construct underground. As their population grows, they dig new burrows, joining them up with tunnels. The space that such complexes occupy can sometimes equal the size of a small city, and thus ventilation assumes a vital importance. Therefore prairie dogs build aboveground towers where their tunnels emerge, rather like volcanoes, which let air be drawn into the city below.

Air travels from regions of high pressure to areas of low.



Some of the towers that prairie dogs build are taller than others. Their differences in height give rise to different levels of air pressure in the tunnel entrances. This way, air enters towers with low air pressure above them and emerges through ones with high pressure. Air drawn into the tunnels passes through all the nests, thus establishing an ideal air circulation system.<sup>133</sup>

To construct a ventilation system such as employed in prairie dogs' tunnels, knowledge of tunnel building, of high and low air pressure, and how they change with altitude are all essential. All these considerations require consciousness, and all these activities indicate the presence of reason and judgment. Therefore, we need to examine the source of this intelligence in the prairie dogs, since clearly it does not belong to the animals themselves—and, contrary to what evolutionists claim, cannot have resulted from blind chance.

God, Who provides countless examples in nature for mankind to



ponder upon, created prairie dogs, like all living things on Earth. Every rational person needs to think, listen to the voice of his conscience and turn to God whenever he encounters an example of beauty; because God is the All-forgiving, the Lord of infinite justice. In the Qur'an, God gives glad tidings to servants who believe in Him:

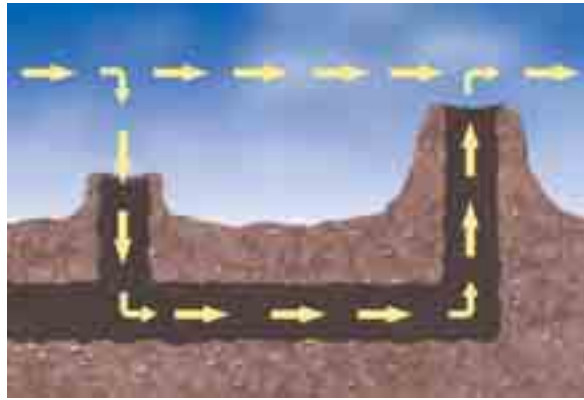

**Your Lord knows best what is in your selves. If you are righteous, He is Ever-Forgiving to the remorseful. (Qur'an, 17: 25)**

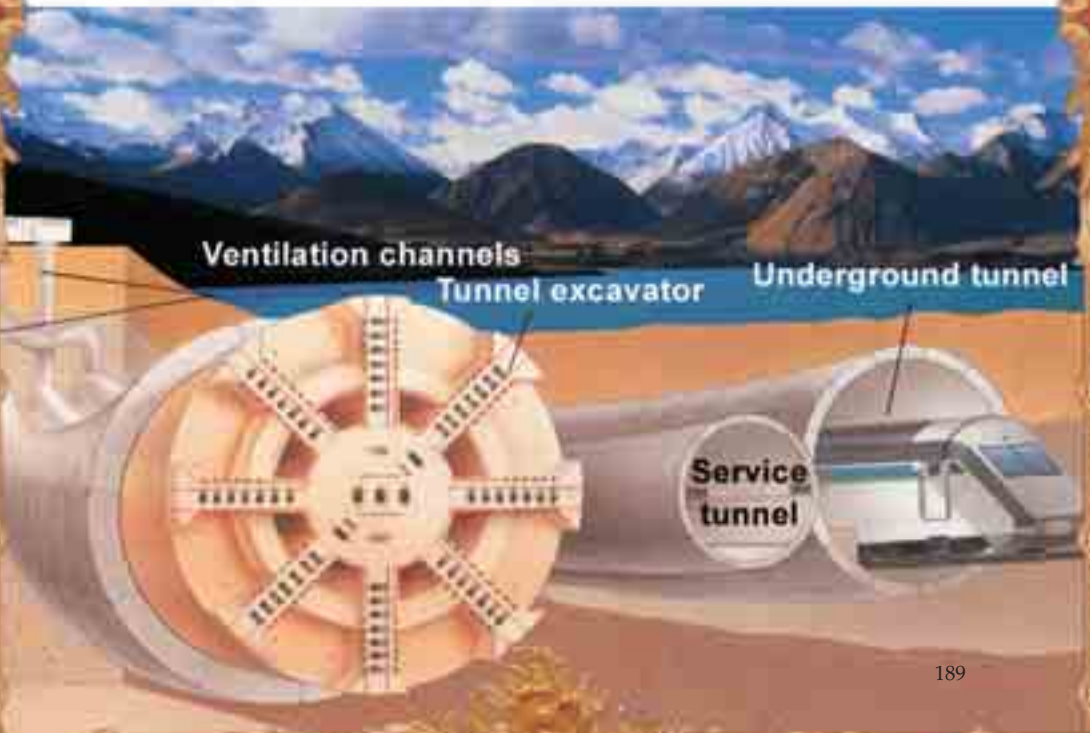



## Wasps and the Paper Industry

A series of chemical processes turn logs of wood into a kind of pulp that can later be made into paper. However, the natural inventors of paper are actually wasps.

To build their nests, wasps use paper that they make by mixing their saliva with shreds of chewed wood. Our furniture industry makes chipboard in exactly the same way, although using glue instead of saliva.<sup>134</sup>

Any wasp resembles a particularly efficient tree-processing and paper making factory. However, all of the processes carried out by large industrial complexes,

wasps perform within their own tiny bodies. The paper industry still has a lot to learn from wasps!

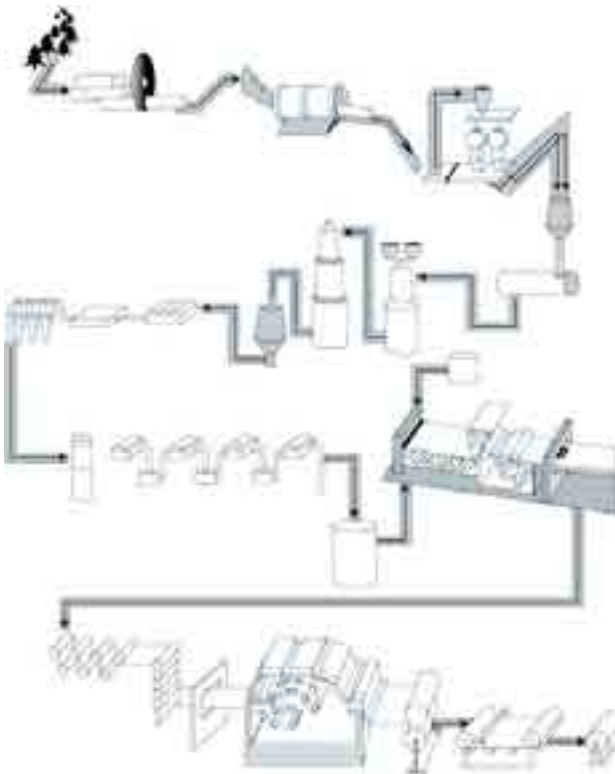

This diagram shows the various processes in paper manufacturing. If just one of these stages were skipped, no paper could be produced. The equivalent to all these processes is carried out in the tiny body of the wasp, just a few centimeters long.

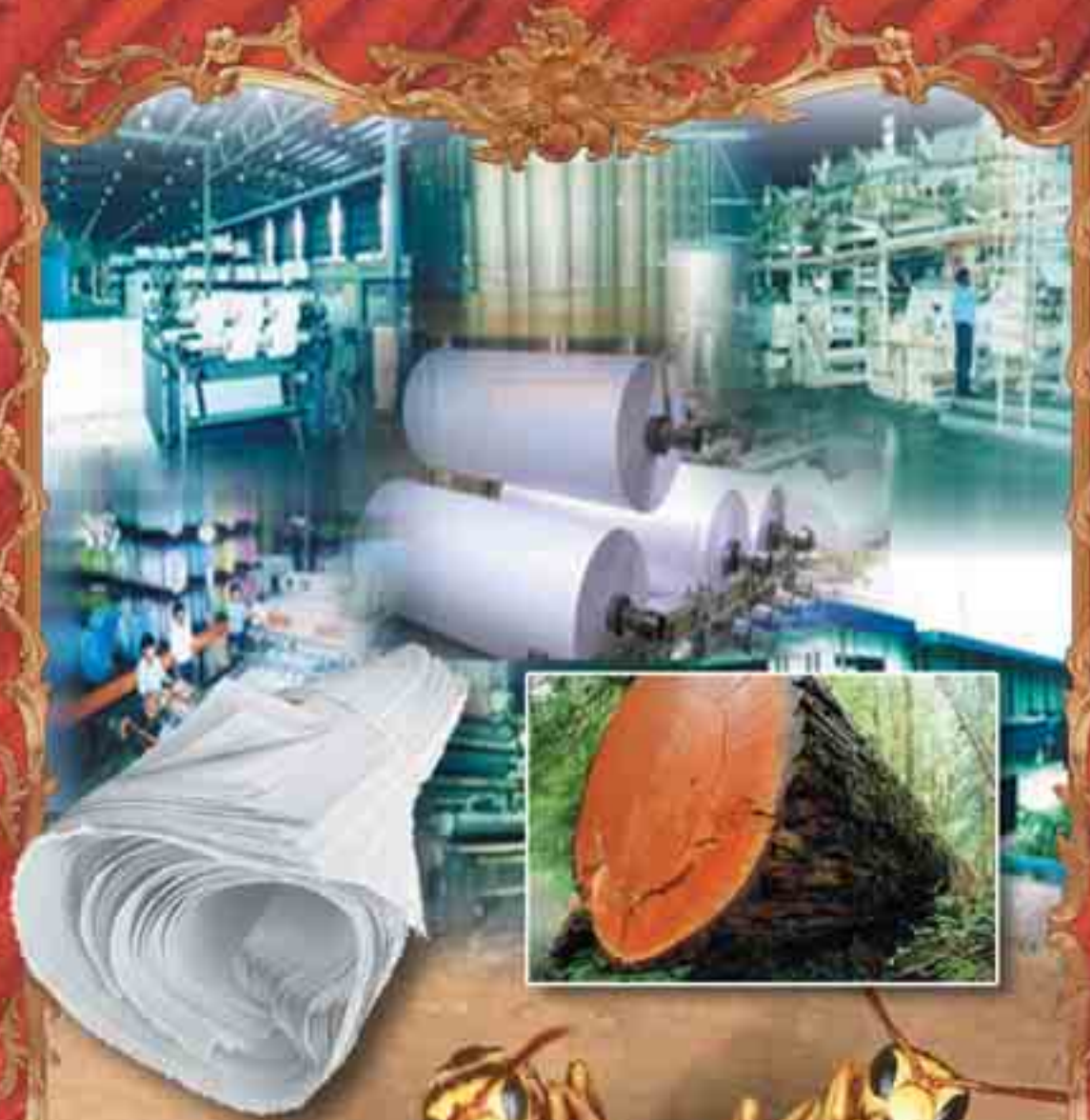

## A Robotic Arm Inspired by the Elephant's Trunk

As scientists tried to design a robotic arm, one of the worst problems they faced was achieving freedom of movement. In order for a robot's arm to serve any useful purpose, it must be able to perform all the movements required by that particular task. In nature, God has created all creatures with the ability to move their limbs in such a way as to meet all their needs. An elephant's trunk, with its 50,000 or so muscles,<sup>135</sup> is one of the most striking examples.

The elephant is able to move its trunk in any direction it wants and can perform tasks requiring the greatest care and sensitivity.

One robotic arm constructed in the U.S. at Rice University clearly reveals the elephant trunk's superior design. There is no single skeleton-like structure in the trunk, thus endowing it with enormous flexibility and lightness. The robotic arm, on the other hand, does have a spine. The elephant's trunk possesses a degree of movement which allows it to move in any direction, while the robotic arm is comprised of 32 degrees of freedom in 16 links.<sup>136</sup>

This only goes to show that the elephant trunk is a special structure, whose every particular feature reveals the nature of God's flawless art in creation.

**Left: A robotic arm with six degrees of freedom. Above: A robotic trunk, modeled on the elephant's, has 32 degrees of freedom. Elephants' trunks have incomparably greater abilities and freedom of movement. If they had to use these artificial trunks instead of their own, they'd encounter severe difficulties.**

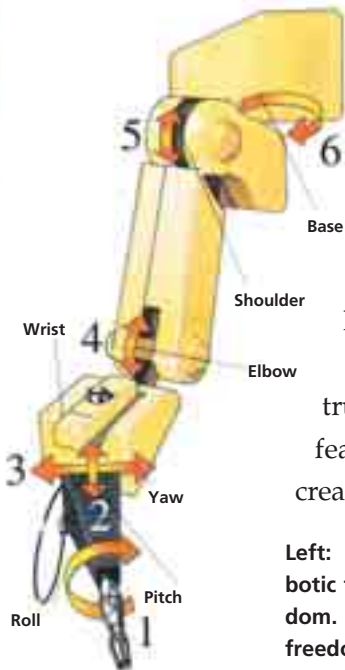



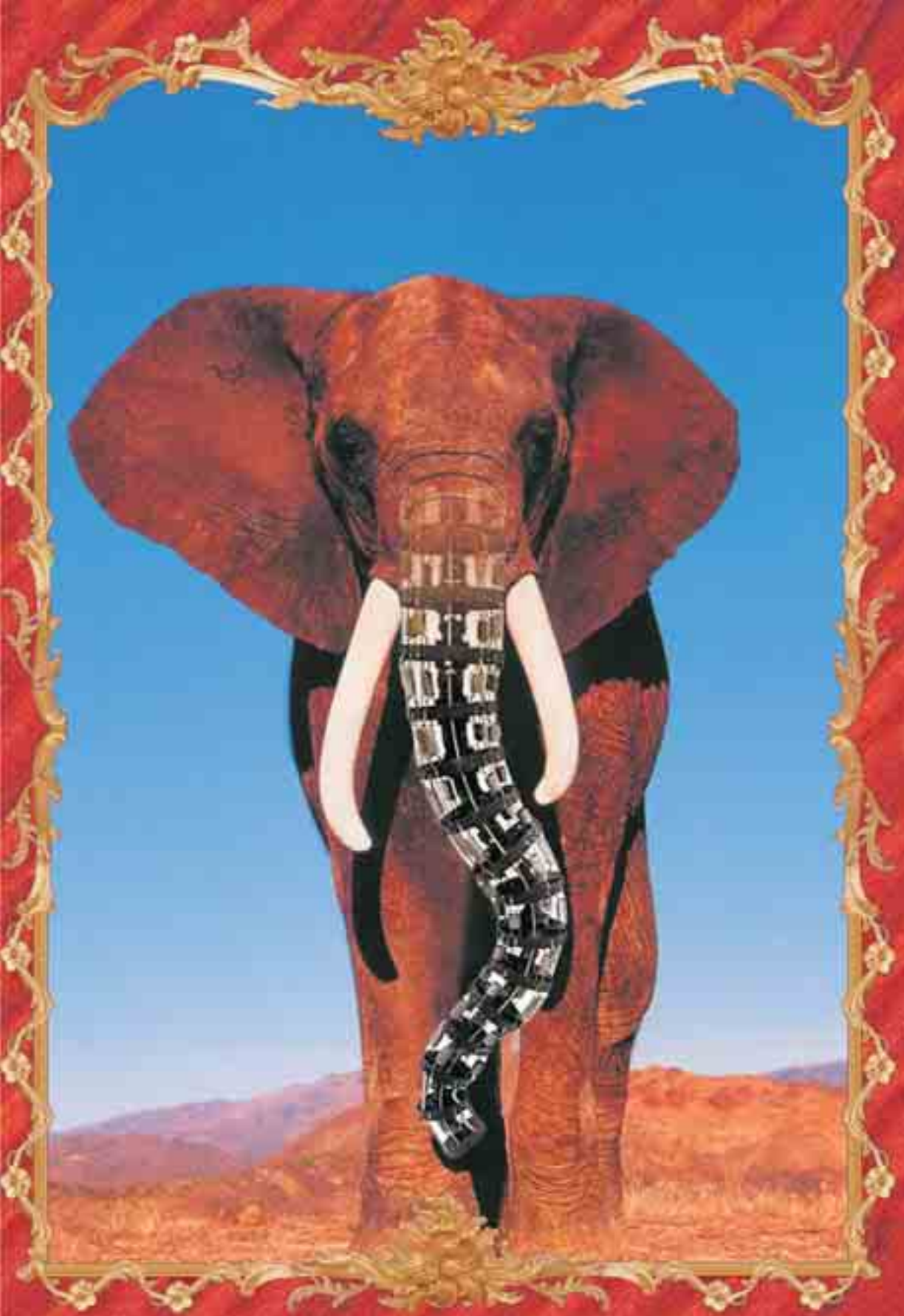

## Conclusion

Scientists are continually amazed at the incomparable structures and systems they discover in nature—and they express their wonder by copying them to create new technologies for mankind's benefit. They've realized that those impeccable systems and extraordinary techniques that nature employs, far superior to their own knowledge and capabilities, offer incomparable solutions to existing problems. Accordingly, they're now resorting to natural designs in a great many areas where, after years of effort, they've been unable to come up with solutions. As a result, they've been able to produce successful results within very short spaces of time. Furthermore, by imitating nature, scientists have saved considerable terms of time and effort, and applied material resources far more effectively.

Recognizing the superior nature of natural designs, evolutionists are suffering yet another disappointment, another loss of hope. Once again, their unscientific claims that living things develop gradually, from the simple to the complex, and that the designs of living things came about through chance has been demonstrated to be untrue. Also, they've had to accept, albeit unwillingly, that the incomparable art that has so astonished them—that the knowledge and reason they so greatly admire—cannot be the work of chance, but only of our Almighty Creator.

It is God, the Lord of the worlds, Who creates the flawless and unmatched systems in all living things; He Who creates everything flawlessly. Those who refuse to accept this fact will suffer an irreparable sorrow on the Day of Judgment. In the Qur'an, God describes how such people waste their time in this world. The Qur'an describes in these terms the impeccable nature of our Lord's artistry:

**He, Who created the seven heavens in layers. You will not find any flaw in the creation of the All-Merciful. Look again—do you see any gaps? Then look again and again. Your sight will return to you dazzled and exhausted! (Qur'an, 67: 3-4)**

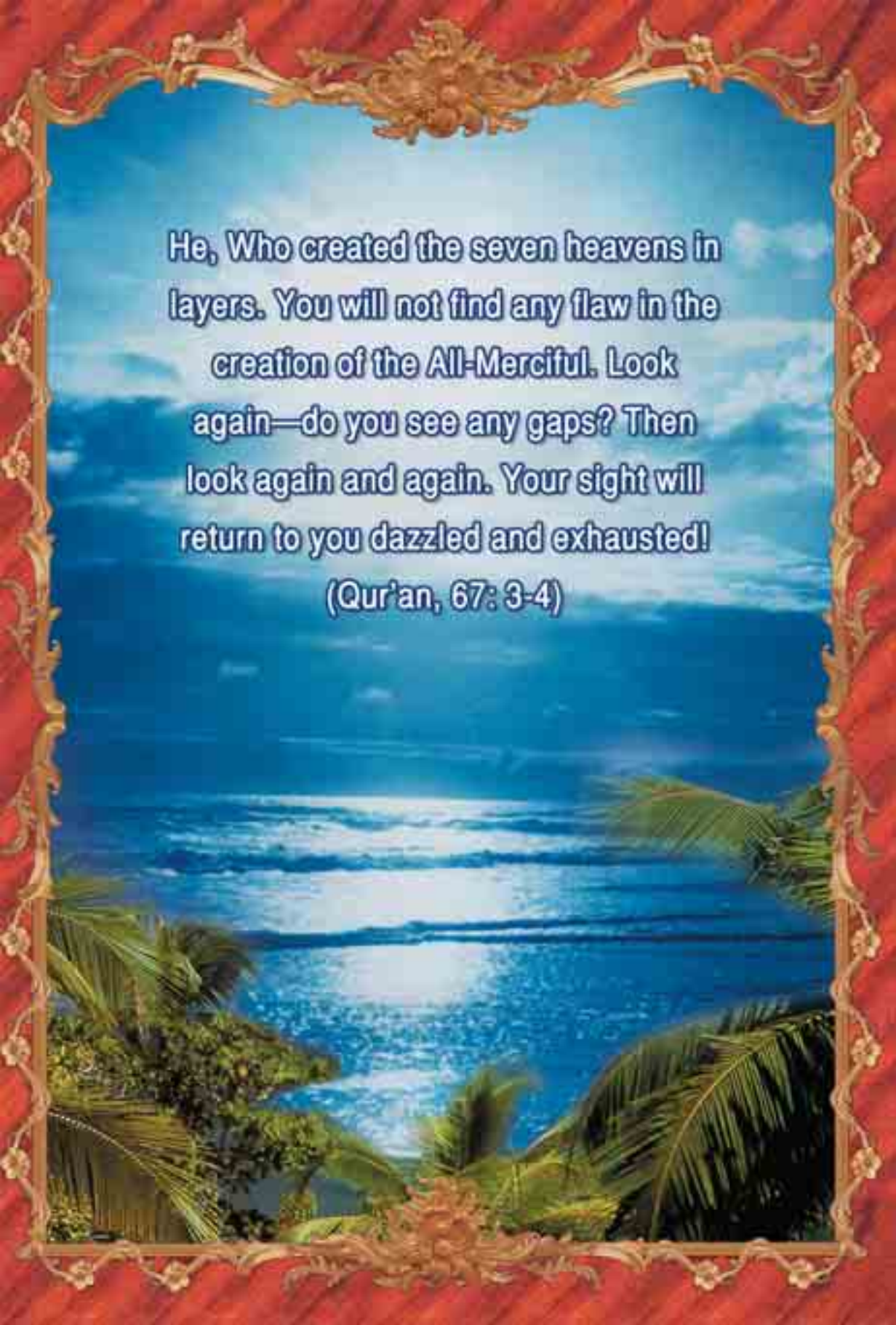

He, Who created the seven heavens in layers. You will not find any flaw in the creation of the All-Merciful. Look again—do you see any gaps? Then look again and again. Your sight will return to you dazzled and exhausted!  
(Qur'an, 67: 3-4)



Appendix:  
**DECEPTION OF  
EVOLUTION**



arwinism, in other words the theory of evolution, was put forward with the aim of denying the fact of creation, but is in truth nothing but failed, unscientific nonsense. This theory, which claims that life emerged by chance from inanimate matter, was invalidated by the scientific evidence of clear "design" in the universe and in living things. In this way, science confirmed the fact that God created the universe and the living things in it. The propaganda carried out today in order to keep the theory of evolution alive is based solely on the distortion of the scientific facts, biased interpretation, and lies and falsehoods disguised as science.

Yet this propaganda cannot conceal the truth. The fact that the theory of evolution is the greatest deception in the history of science has been expressed more and more in the scientific world over the last 20-30 years. Research carried out after the 1980s in particular has revealed that the claims of Darwinism are totally unfounded, something that has been stated by a large number of scientists. In the United States in particular, many scientists from such different fields as biology, biochemistry and paleontology recognize the invalidity of Darwinism and employ the fact of creation to account for the origin of life.

We have examined the collapse of the theory of evolution and the proofs of creation in great scientific detail in many of our works, and are still continuing to do so. Given the enormous importance of this subject, it will be of great benefit to summarize it here.



### **The Scientific Collapse of Darwinism**

Although this doctrine goes back as far as ancient Greece, the theory of evolution was advanced extensively in the nineteenth century. The most important development that made it the top topic of the world of science was Charles Darwin's *The Origin of Species*, published in 1859. In this book, he denied that God created different living species on Earth separately, for he claimed that all living beings had a common ancestor and had diversified over time through small changes. Darwin's theory was not based on any concrete scientific finding; as he also accepted, it was just an "assumption." Moreover, as Darwin confessed in the long chapter of his book titled "Difficulties on Theory," the theory failed in the face of many critical questions.

Darwin invested all of his hopes in new scientific discoveries, which he expected to solve these difficulties. However, contrary to his expectations, scientific findings expanded the dimensions of these difficulties. The defeat of Darwinism in the face of science can be reviewed under three basic topics:

- 1) The theory cannot explain how life originated on Earth.
- 2) No scientific finding shows that the "evolutionary mechanisms"

proposed by the theory have any evolutionary power at all.

3) The fossil record proves the exact opposite of what the theory suggests.

In this section, we will examine these three basic points in general outlines:

### **The First Insurmountable Step: The Origin of Life**

The theory of evolution posits that all living species evolved from a single living cell that emerged on the primitive Earth 3.8 billion years ago. How a single cell could generate millions of complex living species and, if such an evolution really occurred, why traces of it cannot be observed in the fossil record are some of the questions that the theory cannot answer. However, first and foremost, we need to ask: How did this "first cell" originate?

Since the theory of evolution denies creation and any kind of supernatural intervention, it maintains that the "first cell" originated coincidentally within the laws of nature, without any design, plan or arrangement. According to the theory, inanimate matter must have produced a living cell as a result of coincidences. Such a claim, however, is inconsistent with the most unassailable rules of biology.

### **"Life Comes From Life"**

In his book, Darwin never referred to the origin of life. The primitive understanding of science in his time rested on the assumption that living beings had a very simple structure. Since medieval times, spontaneous generation, which asserts that non-living materials came together to form living organisms, had been widely accepted. It was commonly believed that insects came into being from food leftovers, and

mice from wheat. Interesting experiments were conducted to prove this theory. Some wheat was placed on a dirty piece of cloth, and it was believed that mice would originate from it after a while.

Similarly, maggots developing in rotting meat was assumed to be evidence of spontaneous generation. However, it was later understood that worms did not appear on meat spontaneously, but were carried there by flies in the form of larvae, invisible to the naked eye.

Even when Darwin wrote *The Origin of Species*, the belief that bacteria could come into existence from non-living matter was widely accepted in the world of science.

However, five years after the publication of Darwin's book, Louis Pasteur announced his results after long studies and experiments, that disproved spontaneous generation, a cornerstone of Darwin's theory. In his triumphant lecture at the Sorbonne in 1864, Pasteur said: "Never will the doctrine of spontaneous generation recover from the mortal blow struck by this simple experiment."<sup>137</sup>

For a long time, advocates of the theory of evolution resisted these findings. However, as the development of science unraveled the complex structure of the cell of a living being, the idea that life could come into being coincidentally faced an even greater impasse.

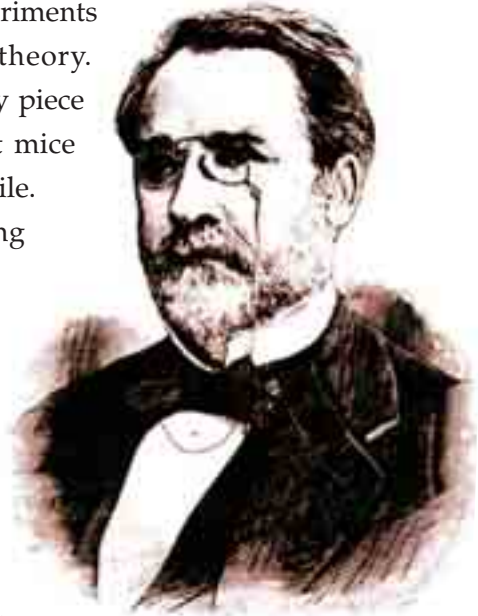

French chemist Louis Pasteur



## Inconclusive Efforts of the Twentieth Century

The first evolutionist who took up the subject of the origin of life in the twentieth century was the renowned Russian biologist Alexander Oparin. With various theses he advanced in the 1930s, he tried to prove that a living cell could originate by coincidence. These studies, however, were doomed to failure, and Oparin had to make the following confession:



**Russian biologist Alexander Oparin**

*Unfortunately, however, the problem of the origin of the cell is perhaps the most obscure point in the whole study of the evolution of organisms.<sup>138</sup>*

Evolutionist followers of Oparin tried to carry out experiments to solve this problem. The best known experiment was carried out by the American chemist Stanley Miller in 1953. Combining the gases he alleged to have existed in the primordial Earth's atmosphere in an experiment set-up, and adding energy to the mixture, Miller synthesized several organic molecules

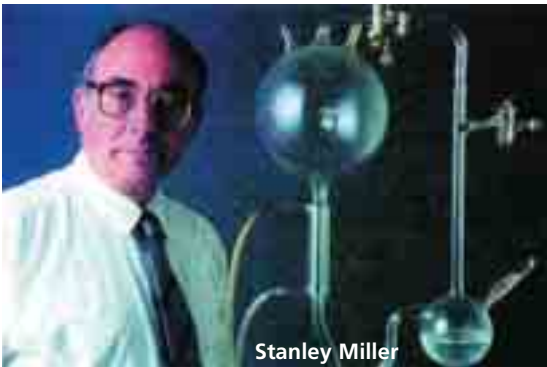

**Stanley Miller**

present in the structure of proteins.

Barely a few years had passed before it was revealed that this experiment, which was then presented as an important

step in the name of evolution, was invalid, for the atmosphere used in the experiment was very different from the real Earth conditions.<sup>139</sup>

After a long silence, Miller confessed that the atmosphere medium he used was unrealistic.<sup>140</sup>

All the evolutionists' efforts throughout the twentieth century to explain the origin of life ended in failure. The geochemist Jeffrey Bada, from the San Diego Scripps Institute accepts this fact in an article published in *Earth* magazine in 1998:

*Today as we leave the twentieth century, we still face the biggest unsolved problem that we had when we entered the twentieth century: How did life originate on Earth?*<sup>141</sup>



One of the evolutionists' gravest deceptions is the way they imagine that life could have emerged spontaneously on what they refer to as the primitive Earth, represented in the picture above. They tried to prove these claims with such studies as the Miller experiment. Yet they again suffered defeat in the face of the scientific facts: The results obtained in the 1970s proved that the atmosphere on what they describe as the primitive Earth was totally unsuited to life.

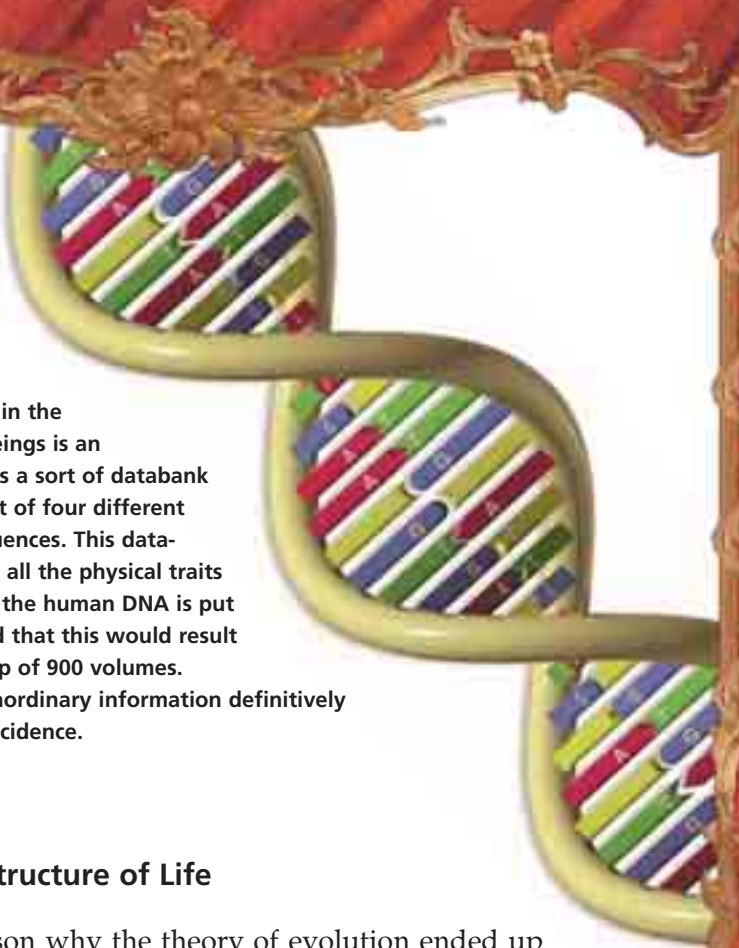

One of the facts nullifying the theory of evolution is the incredibly complex structure of life.

The DNA molecule located in the nucleus of cells of living beings is an example of this. The DNA is a sort of databank formed of the arrangement of four different molecules in different sequences. This databank contains the codes of all the physical traits of that living being. When the human DNA is put into writing, it is calculated that this would result in an encyclopedia made up of 900 volumes. Unquestionably, such extraordinary information definitively refutes the concept of coincidence.

## The Complex Structure of Life

The primary reason why the theory of evolution ended up in such a great impasse regarding the origin of life is that even those living organisms deemed to be the simplest have incredibly complex structures. The cell of a living thing is more complex than all of our man-made technological products. Today, even in the most developed laboratories of the world, a living cell cannot be produced by bringing organic chemicals together.

The conditions required for the formation of a cell are too great in quantity to be explained away by coincidences. The probability of proteins, the building blocks of a cell, being synthesized coincidentally, is 1 in  $10^{950}$  for an average protein made up of 500 amino acids. In mathematics, a probability smaller than 1 over  $10^{50}$  is considered to be impossible in practical terms.

The DNA molecule, which is located in the nucleus of a cell and

which stores genetic information, is an incredible databank. If the information coded in DNA were written down, it would make a giant library consisting of an estimated 900 volumes of encyclopedias consisting of 500 pages each.

A very interesting dilemma emerges at this point: DNA can replicate itself only with the help of some specialized proteins (enzymes). However, the synthesis of these enzymes can be realized only by the information coded in DNA. As they both depend on each other, they have to exist at the same time for replication. This brings the scenario that life originated by itself to a deadlock. Prof. Leslie Orgel, an evolutionist of repute from the University of San Diego, California, confesses this fact in the September 1994 issue of the *Scientific American* magazine:

*It is extremely improbable that proteins and nucleic acids, both of which are structurally complex, arose spontaneously in the same place at the same time. Yet it also seems impossible to have one without the other. And so, at first glance, one might have to conclude that life could never, in fact, have originated by chemical means.<sup>142</sup>*



No doubt, if it is impossible for life to have originated from natural causes, then it has to be accepted that life was "created" in a supernatural way. This fact explicitly invalidates the theory of evolution, whose main purpose is to deny creation.

## Imaginary Mechanism of Evolution

The second important point that negates Darwin's theory is that both concepts put forward by the theory as "evolutionary mechanisms" were understood to have, in reality, no evolutionary power.

Darwin based his evolution allegation entirely on the mechanism of "natural selection." The importance he placed on this mechanism was evident in the name of his book: *The Origin of Species, By Means of Natural Selection...*

Natural selection holds that those living things that are stronger and more suited to the natural conditions of their habitats will survive in the struggle for life. For example, in a deer herd under the threat of attack by wild animals, those that can run faster will survive. Therefore, the deer herd will be comprised of faster and stronger individuals. However, unquestionably, this mechanism will not cause deer to evolve and transform themselves into another living species, for instance, horses.

Therefore, the mechanism of



French naturalist Lamarck



Lamarck believed that giraffes evolved from such animals as antelopes. In his view, the necks of these grass-eating animals gradually grew longer, and they eventually turned into giraffes. The laws of inheritance discovered by Mendel in 1865 proved that it was impossible for properties acquired during life to be handed on to subsequent generations. Lamarck's giraffe fairy tale was thus consigned to the wastebin of history.

natural selection has no evolutionary power. Darwin was also aware of this fact and had to state this in his book *The Origin of Species*:

*Natural selection can do nothing until favourable individual differences or variations occur.*<sup>143</sup>

### Lamarck's Impact

So, how could these "favorable variations" occur? Darwin tried to answer this question from the standpoint of the primitive understanding of science at that time. According to the French biologist Chevalier de Lamarck (1744-1829), who lived before Darwin, living creatures passed on the traits they acquired during their lifetime to the next generation. He asserted that these traits, which accumulated from one generation to another, caused new species to be formed. For instance, he claimed that giraffes evolved from antelopes; as they struggled to eat the leaves of high trees, their necks were extended from generation to generation.



**Accidental mutations develop into defects in humans as well as other living beings. The Chernobyl disaster is an eye-opener for the effects of mutations.**

Darwin also gave similar examples. In his book *The Origin of Species*, for instance, he said that some bears going into water to find food transformed themselves into whales over time.<sup>144</sup>

However, the laws of inheritance discovered by Gregor Mendel (1822-84) and verified by the science of genetics, which flourished in the twentieth century, utterly demolished the legend that acquired traits were passed on to subsequent generations. Thus, natural selection fell out of

favor as an evolutionary mechanism.

## Neo-Darwinism and Mutations

In order to find a solution, Darwinists advanced the "Modern Synthetic Theory," or as it is more commonly known, Neo-Darwinism, at the end of the 1930s. Neo-Darwinism added mutations, which are distortions formed in the genes of living beings due to such external factors as radiation or replication errors, as the "cause of favorable variations" in addition to natural mutation.

Today, the model that stands for evolution in the world is Neo-Darwinism. The theory maintains that millions of living beings formed as a result of a process whereby numerous complex organs of these organisms (e.g., ears, eyes, lungs, and wings) underwent "mutations," that is, genetic disorders. Yet, there is an outright scientific fact that totally undermines this theory: Mutations do not cause living beings to develop; on the contrary, they are always harmful.

The reason for this is very simple: DNA has a very complex structure, and random effects can only harm it. The American geneticist B. G. Ranganathan explains this as follows:

*First, genuine mutations are very rare in nature. Secondly, most mutations are harmful since they are random, rather than orderly changes in the structure of genes; any random change in a highly ordered system will be for the worse, not for the better. For example, if an earthquake were to shake a highly ordered structure such as a building, there would be a random change in the framework of the building which, in all probability, would not be an improvement.<sup>145</sup>*

Not surprisingly, no mutation example, which is useful, that is, which is observed to develop the genetic code, has been observed so far. All mutations have proved to be harmful. It was understood that mutation, which is presented as an "evolutionary mechanism," is actually a



The larger picture belongs to a 100-million-year-old Nautilus fossil. On the left is a Nautilus living in our day. When we compare the fossil with today's Nautilus (on the right is the cross section of the creature's shell), we see that they both have the same identical characteristics.

genetic occurrence that harms living things, and leaves them disabled. (The most common effect of mutation on human beings is cancer.) Of course, a destructive mechanism cannot be an "evolutionary mechanism." Natural selection, on the other hand, "can do nothing by itself," as Darwin also accepted. This fact shows us that there is no "evolutionary mechanism" in nature. Since no evolutionary mechanism exists, no such any imaginary process called "evolution" could have taken place.

### **The Fossil Record: No Sign of Intermediate Forms**

The clearest evidence that the scenario suggested by the theory of evolution did not take place is the fossil record.

According to this theory, every living species has sprung from a predecessor. A previously existing species turned into something else over time and all species have come into being in this way. In other



words, this transformation proceeds gradually over millions of years.

Had this been the case, numerous intermediary species should have existed and lived within this long transformation period.

For instance, some half-fish/half-reptiles should have lived in the past which had acquired some reptilian traits in addition to the fish traits they already had. Or there should have existed some reptile-birds, which acquired some bird traits in addition to the reptilian traits they already had. Since these would be in a transitional phase, they should be disabled, defective, crippled living beings. Evolutionists refer to these imaginary creatures, which they believe to have lived in the past, as "transitional forms."

If such animals ever really existed, there should be millions and even billions of them in number and variety. More importantly, the remains of these strange creatures should be present in the fossil record. In *The Origin of Species*, Darwin explained:

*If my theory be true, numberless intermediate varieties, linking most closely all of the species of the same group together must assuredly have existed... Consequently, evidence of their former existence could be found only amongst fossil remains.<sup>146</sup>*

### **Darwin's Hopes Shattered**

However, although evolutionists have been making strenuous efforts to find fossils since the middle of the nineteenth century all over the world, no transitional forms have yet been uncovered. All of the fossils, contrary to the evolutionists' expectations, show that life appeared on Earth all of a sudden and fully-formed.

One famous British paleontologist, Derek V. Ager, admits this fact, even though he is an evolutionist:



Evolutionist newspapers and magazines often print pictures of primitive man. The only available source for these pictures is the imagination of the artist. Evolutionary theory has been so dented by scientific data that today we see less and less of it in the serious press.

*The point emerges that if we examine the fossil record in detail, whether at the level of orders or of species, we find – over and over again – not gradual evolution, but the sudden explosion of one group at the expense of another.<sup>147</sup>*

This means that in the fossil record, all living species suddenly emerge as fully formed, without any intermediate forms in between. This is just the opposite of Darwin's assumptions. Also, this is very strong evidence that all living things are created. The only explanation of a living species emerging suddenly and complete in every detail without any evolutionary ancestor is that it was created. This fact is admitted also by the widely known evolutionist biologist Douglas Futuyma:

*Creation and evolution, between them, exhaust the possible explanations for the origin of living things. Organisms either appeared on the earth fully developed or they did not. If they did not, they must have developed from pre-existing species by some process of modification. If they did appear in a fully developed state, they must indeed have been created by some omnipotent intelligence.<sup>148</sup>*

Fossils show that living beings emerged fully developed and in a perfect state on the Earth. That means that "the origin of species," contrary to Darwin's supposition, is not evolution, but creation.

### **The Tale of Human Evolution**

The subject most often brought up by advocates of the theory of evolution is the subject of the origin of man. The Darwinist claim holds that modern man evolved from ape-like creatures. During this alleged evolutionary process, which is supposed to have started 4-5 million years ago, some "transitional forms" between modern man and his ancestors are supposed to have existed. According to this completely imaginary scenario, four basic "categories" are listed:

1. *Australopithecus*
2. *Homo habilis*
3. *Homo erectus*
4. *Homo sapiens*

Evolutionists call man's so-called first ape-like ancestors *Australopithecus*, which means "South African ape." These living beings are actually nothing but an old ape species that has become extinct. Extensive research done on various *Australopithecus* specimens by two world famous anatomists from England and the USA, namely, Lord Solly Zuckerman and Prof. Charles Oxnard, shows that these apes belonged to an ordinary ape species that became extinct and bore no resemblance to humans.<sup>149</sup>

Evolutionists classify the next stage of human evolution as "homo," that is "man." According to their claim, the living beings in the Homo series are more developed than *Australopithecus*. Evolutionists devise a fanciful evolution scheme by arranging different fossils of these crea-

tures in a particular order. This scheme is imaginary because it has never been proved that there is an evolutionary relation between these different classes. Ernst Mayr, one of the twentieth century's most important evolutionists, contends in his book *One Long Argument* that "particularly historical [puzzles] such as the origin of life or of *Homo sapiens*, are extremely difficult and may even resist a final, satisfying explanation."<sup>150</sup>

By outlining the link chain as *Australopithecus* > *Homo habilis* > *Homo erectus* > *Homo sapiens*, evolutionists imply that each of these species is one another's ancestor. However, recent findings of paleoanthropologists have revealed that *Australopithecus*, *Homo habilis*, and *Homo erectus* lived at different parts of the world at the same time.<sup>151</sup>

Moreover, a certain segment of humans classified as *Homo erectus* have lived up until very modern times. *Homo sapiens neandarthalensis* and *Homo sapiens sapiens* (modern man) co-existed in the same region.<sup>152</sup>

This situation apparently indicates the invalidity of the claim that they are ancestors of one another. Stephen Jay Gould explained this deadlock of the theory of evolution, although he was himself one of the leading advocates of evolution in the twentieth century:

*What has become of our ladder if there are three coexisting lineages of hominids (A. africanus, the robust australopithecines, and H. habilis), none clearly derived from another? Moreover, none of the three display any evolutionary trends during their tenure on earth.*<sup>153</sup>

Put briefly, the scenario of human evolution, which is "upheld" with the help of various drawings of some "half ape, half human" creatures appearing in the media and course books, that is, frankly, by means of propaganda, is nothing but a tale with no scientific foundation.

Lord Solly Zuckerman, one of the most famous and respected sci-

entists in the U.K., who carried out research on this subject for years and studied *Australopithecus* fossils for 15 years, finally concluded, despite being an evolutionist himself, that there is, in fact, no such family tree branching out from ape-like creatures to man.

Zuckerman also made an interesting "spectrum of science" ranging from those he considered scientific to those he considered unscientific. According to Zuckerman's spectrum, the most "scientific" – that is, depending on concrete data – fields of science are chemistry and physics. After them come the biological sciences and then the social sciences. At the far end of the spectrum, which is the part considered to be most "unscientific," are "extra-sensory perception" – concepts such as telepathy and sixth sense – and finally "human evolution." Zuckerman explains his reasoning:

*We then move right off the register of objective truth into those fields of presumed biological science, like extrasensory perception or the interpretation of man's fossil history, where to the faithful [evolutionist] anything is possible – and where the ardent believer [in evolution] is sometimes able to believe several contradictory things at the same time.<sup>154</sup>*

The tale of human evolution boils down to nothing but the prejudiced interpretations of some fossils unearthed by certain people, who blindly adhere to their theory.

### **Darwinian Formula!**

Besides all the technical evidence we have dealt with so far, let us now for once, examine what kind of a superstition the evolutionists have with an example so simple as to be understood even by children:

The theory of evolution asserts that life is formed by chance. According to this claim, lifeless and unconscious atoms came together

to form the cell and then they somehow formed other living things, including man. Let us think about that. When we bring together the elements that are the building-blocks of life such as carbon, phosphorus, nitrogen and potassium, only a heap is formed. No matter what treatments it undergoes, this atomic heap cannot form even a single living being. If you like, let us formulate an "experiment" on this subject and let us examine on the behalf of evolutionists what they really claim without pronouncing loudly under the name "Darwinian formula":

Let evolutionists put plenty of materials present in the composition of living things such as phosphorus, nitrogen, carbon, oxygen, iron, and magnesium into big barrels. Moreover, let them add in these bar-



**Compared to cameras and sound recording devices, the eye and ear are much more complex, much more successful and possess far superior features to these products of high technology.**

rels any material that does not exist under normal conditions, but they think as necessary. Let them add in this mixture as many amino acids and as many proteins – a single one of which has a formation probability of  $10^{-950}$  – as they like. Let them expose these mixtures to as much heat and moisture as they like. Let them stir these



with whatever technologically developed device they like. Let them put the foremost scientists beside these barrels. Let these experts wait in turn beside these barrels for billions, and even trillions of years. Let them be free to use all kinds of conditions they believe to be necessary for a human's formation. No matter what they do, they cannot produce from these barrels a human, say a professor that examines his cell structure under the electron microscope. They cannot produce giraffes, lions, bees, canaries, horses, dolphins, roses, orchids, lilies, carnations, bananas, oranges, apples, dates, tomatoes, melons, watermelons, figs, olives, grapes, peaches, peafowls, pheasants, multicoloured butterflies, or millions of other living beings such as these. Indeed, they could not obtain even a single cell of any one of them.

Briefly, unconscious atoms cannot form the cell by coming together. They cannot take a new decision and divide this cell into two, then take other decisions and create the professors who first invent the electron microscope and then examine their own cell structure under that



microscope. Matter is an unconscious, lifeless heap, and it comes to life with God's superior creation.

The theory of evolution, which claims the opposite, is a total fallacy completely contrary to reason. Thinking even a little bit on the claims of evolutionists discloses this reality, just as in the above example.

### **Technology in the Eye and the Ear**

Another subject that remains unanswered by evolutionary theory is the excellent quality of perception in the eye and the ear.

Before passing on to the subject of the eye, let us briefly answer the question of how we see. Light rays coming from an object fall oppositely on the eye's retina. Here, these light rays are transmitted into electric signals by cells and reach a tiny spot at the back of the brain, the "center of vision." These electric signals are perceived in this center as an image after a series of processes. With this technical background, let us do some thinking.

The brain is insulated from light. That means that its inside is completely dark, and that no light reaches the place where it is located.



Thus, the "center of vision" is never touched by light and may even be the darkest place you have ever known. However, you observe a luminous, bright world in this pitch darkness.

The image formed in the eye is so sharp and distinct that even the technology of the twentieth century has not been able to attain it. For instance, look at the book you are reading, your hands with which you are holding it, and then lift your head and look around you. Have you ever seen such a sharp and distinct image as this



one at any other place? Even the most developed television screen produced by the greatest television producer in the world cannot provide such a sharp image for you. This is a three-dimensional, colored, and extremely sharp image. For more than 100 years, thousands of engineers have been trying to achieve this sharpness. Factories, huge premises were established, much research has been done, plans and designs have been made for this purpose. Again, look at a TV screen and the book you hold in your hands. You will see that there is a big difference in sharpness and distinction. Moreover, the TV screen shows you a two-dimensional image, whereas with your eyes, you watch a three-dimensional perspective with depth.

For many years, tens of thousands of engineers have tried to make

a three-dimensional TV and achieve the vision quality of the eye. Yes, they have made a three-dimensional television system, but it is not possible to watch it without putting on special 3-D glasses; moreover, it is only an artificial three-dimension. The background is more blurred, the foreground appears like a paper setting. Never has it been possible to produce a sharp and distinct vision like that of the eye. In both the camera and the television, there is a loss of image quality.

Evolutionists claim that the mechanism producing this sharp and distinct image has been formed by chance. Now, if somebody told you that the television in your room was formed as a result of chance, that all of its atoms just happened to come together and make up this device that produces an image, what would you think? How can atoms do what thousands of people cannot?

If a device producing a more primitive image than the eye could not have been formed by chance, then it is very evident that the eye and the image seen by the eye could not have been formed by chance. The same situation applies to the ear. The outer ear picks up the available sounds by the auricle and directs them to the middle ear, the middle ear transmits the sound vibrations by intensifying them, and the inner ear sends these vibrations to the brain by translating them into electric signals. Just as with the eye, the act of hearing finalizes in the center of hearing in the brain.

The situation in the eye is also true for the ear. That is, the brain is insulated from sound just as it is from light. It does not let any sound in. Therefore, no matter how noisy is the outside, the inside of the brain is completely silent. Nevertheless, the sharpest sounds are perceived in the brain. In your completely silent brain, you listen to symphonies, and hear all of the noises in a crowded place. However, were the sound level in your brain measured by a precise device at that moment, complete

Harun Yahya

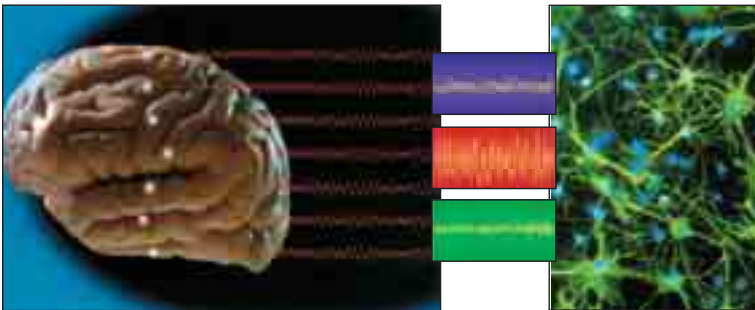
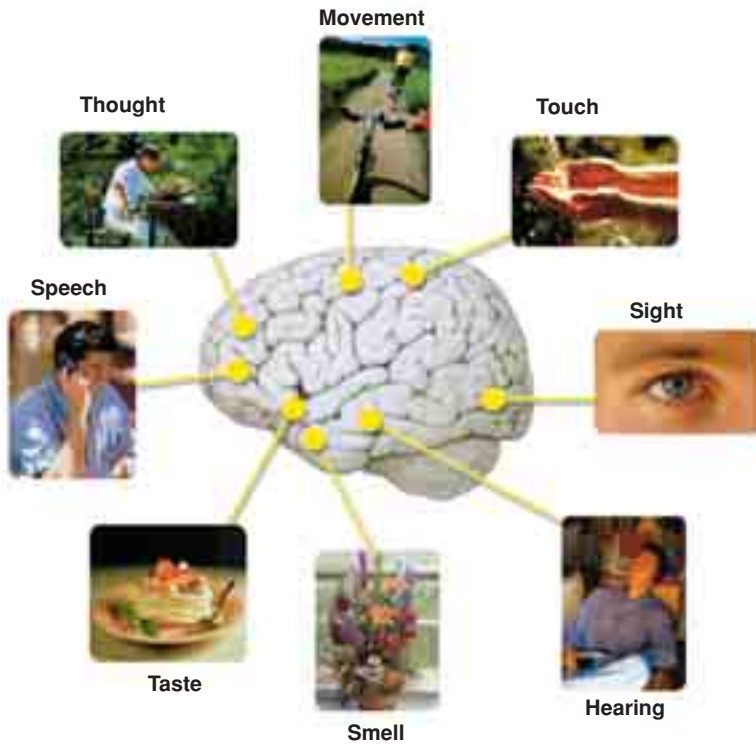

We live our whole life in our brains. People we see, flowers we smell, music we hear, fruit we taste, the moisture we feel with our hands—all these are impressions that become "reality" in the brain. But no colors, voices or pictures exist there. We live in an environment of electrical impulses. This is no theory, but the scientific explanation of how we perceive the outside world.

silence would be found to be prevailing there.

As is the case with imagery, decades of effort have been spent in trying to generate and reproduce sound that is faithful to the original. The results of these efforts are sound recorders, high-fidelity systems, and systems for sensing sound. Despite all of this technology and the thousands of engineers and experts who have been working on this endeavor, no sound has yet been obtained that has the same sharpness and clarity as the sound perceived by the ear. Think of the highest-quality hi-fi systems produced by the largest company in the music industry. Even in these devices, when sound is recorded some of it is lost; or when you turn on a hi-fi you always hear a hissing sound before the music starts. However, the sounds that are the products of the human body's technology are extremely sharp and clear. A human ear never perceives a sound accompanied by a hissing sound or with atmospheric sounds as does a hi-fi; rather, it perceives sound exactly as it is, sharp and clear. This is the way it has been since the creation of man.

So far, no man-made visual or recording apparatus has been as sensitive and successful in perceiving sensory data as are the eye and the ear. However, as far as seeing and hearing are concerned, a far greater truth lies beyond all this.

### **To Whom Does the Consciousness that Sees and Hears within the Brain Belong?**

Who watches an alluring world in the brain, listens to symphonies and the twittering of birds, and smells the rose?

The stimulations coming from a person's eyes, ears, and nose travel to the brain as electro-chemical nerve impulses. In biology, physiology, and biochemistry books, you can find many details about how this image forms in the brain. However, you will never come across the

most important fact: Who perceives these electro-chemical nerve impulses as images, sounds, odors, and sensory events in the brain? There is a consciousness in the brain that perceives all this without feeling any need for an eye, an ear, and a nose. To whom does this consciousness belong? Of course it does not belong to the nerves, the fat layer, and neurons comprising the brain. This is why Darwinist-materialists, who believe that everything is comprised of matter, cannot answer these questions.

For this consciousness is the spirit created by God, which needs neither the eye to watch the images nor the ear to hear the sounds. Furthermore, it does not need the brain to think.

Everyone who reads this explicit and scientific fact should ponder on Almighty God, and fear and seek refuge in Him, for He squeezes the entire universe in a pitch-dark place of a few cubic centimeters in a three-dimensional, colored, shadowy, and luminous form.

### **A Materialist Faith**

The information we have presented so far shows us that the theory of evolution is incompatible with scientific findings. The theory's claim regarding the origin of life is inconsistent with science, the evolutionary mechanisms it proposes have no evolutionary power, and fossils demonstrate that the required intermediate forms have never existed. So, it certainly follows that the theory of evolution should be pushed aside as an unscientific idea. This is how many ideas, such as the Earth-centered universe model, have been taken out of the agenda of science throughout history.

However, the theory of evolution is kept on the agenda of science. Some people even try to represent criticisms directed against it as an

"attack on science." Why?

The reason is that this theory is an indispensable dogmatic belief for some circles. These circles are blindly devoted to materialist philosophy and adopt Darwinism because it is the only materialist explanation that can be put forward to explain the workings of nature.

Interestingly enough, they also confess this fact from time to time. A well-known geneticist and an outspoken evolutionist, Richard C. Lewontin from Harvard University, confesses that he is "first and foremost a materialist and then a scientist":

*It is not that the methods and institutions of science somehow compel us accept a material explanation of the phenomenal world, but, on the contrary, that we are forced by our a priori adherence to material causes to create an apparatus of investigation and a set of concepts that produce material explanations, no matter how counter-intuitive, no matter how mystifying to the uninitiated. Moreover, that materialism is absolute, so we cannot allow a Divine Foot in the door.<sup>155</sup>*

These are explicit statements that Darwinism is a dogma kept alive just for the sake of adherence to materialism. This dogma maintains that there is no being save matter. Therefore, it argues that inanimate, unconscious matter created life. It insists that millions of different living species (e.g., birds, fish, giraffes, tigers, insects, trees, flowers, whales, and human beings) originated as a result of the interactions between matter such as pouring rain, lightning flashes, and so on, out of inanimate matter. This is a precept contrary both to reason and science. Yet Darwinists continue to defend it just so as "not to allow a Divine Foot in the door."

Anyone who does not look at the origin of living beings with a materialist prejudice will see this evident truth: All living beings are works of a Creator, Who is All-Powerful, All-Wise, and All-Knowing. This



**The magicians of Pharaoh were authorities on subjects ranging from astronomy to medicine. They exploited their prestige to influence the public and only to reinforce the oppressive rule of Pharaoh. Above is an ancient Egyptian relief showing the magicians holding the world.**

Creator is God, Who created the whole universe from non-existence, designed it in the most perfect form, and fashioned all living beings.

### **The Theory of Evolution: The Most Potent Spell in the World**

Anyone free of prejudice and the influence of any particular ideology, who uses only his or her reason and logic, will clearly understand that belief in the theory of evolution, which brings to mind the superstitions of societies with no knowledge of science or civilization, is quite impossible.

As explained above, those who believe in the theory of evolution think that a few atoms and molecules thrown into a huge vat could produce thinking, reasoning professors and university students; such scientists as Einstein and Galileo; such artists as Humphrey Bogart, Frank Sinatra and Luciano Pavarotti; as well as antelopes, lemon trees, and carnations. Moreover, as the scientists and professors who believe in this nonsense are educated people, it is quite justifiable to speak of this theory as "the most potent spell in history." Never before has any other belief or idea so taken away peoples' powers of reason, refused to allow them to think in-



**In the same way that the beliefs of people who worshipped crocodiles now seem odd and unbelievable, so the beliefs of Darwinists are just as incredible. Darwinists regard chance and lifeless, unconscious atoms as a creative force, and are as devoted to that belief as if to a religion.**

telligently and logically, and hidden the truth from them as if they had been blindfolded. This is an even worse and unbelievable blindness than the Egyptians worshipping the Sun God Ra, totem worship in some parts of Africa, the people of Saba worshipping the Sun, the tribe of Prophet Abraham (pbuh) worshipping idols they had made with their own hands, or the people of Prophet Moses (pbuh) worshipping the Golden Calf.

In fact, God has pointed to this lack of reason in the Qur'an. In many verses, He reveals that some peoples' minds will be closed and that they will be powerless to see the truth. Some of these verses are as follows:

**As for those who do not believe, it makes no difference to them whether you warn them or do not warn them, they will not believe. God has sealed up their hearts and hearing and over their eyes is a blindfold. They will have a terrible punishment. (Qur'an, 2:6-7)**

**... They have hearts with which they do not understand. They have**



**eyes with which they do not see. They have ears with which they do not hear. Such people are like cattle. No, they are even further astray! They are the unaware. (Qur'an, 7:179)**

**Even if We opened up to them a door into heaven, and they spent the day ascending through it, they would only say: "Our eyesight is befuddled! Or rather we have been put under a spell!" (Qur'an, 15:14-15)**

Words cannot express just how astonishing it is that this spell should hold such a wide community in thrall, keep people from the truth, and not be broken for 150 years. It is understandable that one or a few people might believe in impossible scenarios and claims full of stupidity and illogicality. However, "magic" is the only possible explanation for people from all over the world believing that unconscious and lifeless atoms suddenly decided to come together and form a universe that functions with a flawless system of organization, discipline, reason, and consciousness; a planet named Earth with all of its features so perfectly suited to life; and living things full of countless complex systems.

In fact, the Qur'an relates the incident of Prophet Moses (pbuh) and Pharaoh to show that some people who support atheistic philosophies actually influence others by magic. When Pharaoh was told about the true religion, he told Prophet Moses (pbuh) to meet with his own magicians. When Moses (pbuh) did so, he told them to demonstrate their abilities first. The verses continue:

**He said: "You throw." And when they threw, they cast a spell on the people's eyes and caused them to feel great fear of them. They produced an extremely powerful magic. (Qur'an, 7:116)**

**Glory be to You! We have no  
knowledge except what You  
have taught us. You are the  
All-Knowing, the All-Wise.  
(Qur'an, 2: 32)**

As we have seen, Pharaoh's magicians were able to deceive everyone, apart from Moses (pbuh) and those who believed in him. However, his evidence broke the spell, or "swallowed up what they had forged," as the verse puts it:

**We revealed to Moses, "Throw down your staff." And it immediately swallowed up what they had forged. So the Truth took place and what they did was shown to be false. (Qur'an, 7:117-118)**

As we can see, when people realized that a spell had been cast upon them and that what they saw was just an illusion, Pharaoh's magicians lost all credibility. In the present day too, unless those who, under the influence of a similar spell, believe in these ridiculous claims under their scientific disguise and spend their lives defending them, abandon their superstitious beliefs, they also will be humiliated when the full truth emerges and the spell is broken. In fact, world-renowned British writer and philosopher Malcolm Muggeridge, who was an atheist defending evolution for some 60 years, but who subsequently realized the truth, reveals the position in which the theory of evolution would find itself in the near future in these terms:

*I myself am convinced that the theory of evolution, especially the extent to which it's been applied, will be one of the great jokes in the history books in the future. Posterity will marvel that so very flimsy and dubious an hypothesis could be accepted with the incredible credulity that it has.<sup>156</sup>*

That future is not far off: On the contrary, people will soon see that "chance" is not a deity, and will look back on the theory of evolution as the worst deceit and the most terrible spell in the world. That spell is already rapidly beginning to be lifted from the shoulders of people all over the world. Many people who see its true face are wondering with amazement how they could ever have been taken in by it.

## Notes

1 Nanotechnology means building something by manipulating the placement of pieces that vary in size from 0.1 to 100 nanometers (nm)—roughly the range of size between atoms and molecules.

2 Janine M. Benyus, *Biomimicry, Innovation Inspired By Nature*, William Morrow and Company Inc., New York, 1998;  
[http://www.biomimicry.org/reviews\\_text.htm](http://www.biomimicry.org/reviews_text.htm)

3 “Biomimicry,” Buckminster Fuller Institute;  
<http://www.bfi.org/Trimtab/spring01/biomimicry.htm>

4 Michelle Nijhuis, *High Country News*, July 06, 1998, vol. 30, no. 13;  
[http://www.biomimicry.org/reviews\\_text.htm](http://www.biomimicry.org/reviews_text.htm)

5 Philip Ball, “Life’s lessons in design,” *Nature*, January 18, 2001.

6 A Conversation with Janine Benyus, “Biomimicry Explained;” <http://www.biomimicry.org/faq.html>

7 [http://www.watchtower.org/library/g/2000/1/22/article\\_02.htm](http://www.watchtower.org/library/g/2000/1/22/article_02.htm)

8 <http://www.rdg.ac.uk/biomimetics/projects.htm>

9 *Bilim ve Teknik* (Science and Technology Magazine), TUBITAK Publishings, August 1994, p. 43.

10 Philip Ball, “Life’s lessons in design,” *Nature* 409, 413-416 (2001).

11 “Biomimicry: Secrets Hiding in Plain Sight,” *NBL* 6.22, November 17, 1997;  
<http://www.natlogic.com/resorces/nbl/v06/n22.html>

12 Janine M. Benyus, *Biomimicry: Innovation Inspired By Nature*, William Morrow and Company Inc., New York, 1998;  
[http://www.biomimicry.org/reviews\\_text.htm](http://www.biomimicry.org/reviews_text.htm)

13 Ed Hunt, “Biomimicry: Genius that

Surrounds Us,” Tidepool Editor;  
[http://www.biomimicry.org/reviews\\_text.htm](http://www.biomimicry.org/reviews_text.htm)

14 Robin Eisner, “Biomimetics: Creating Materials From Nature’s Blueprints,” *The Scientist*, July 08, 1991; [http://www.the-scientist.com/yr1991/july/research\\_910708.html](http://www.the-scientist.com/yr1991/july/research_910708.html)

15 Jim Robbins, “Engineers Ask Nature for Design Advice,” *New York Times*, December 11, 2001.

16 David Perlman, “Business and Nature in Productive, Efficient Harmony,” *San Francisco Chronicle*, November 30, 1997, p. 5;  
[http://www.biomimicry.org/reviews\\_text.htm](http://www.biomimicry.org/reviews_text.htm)

17 Ilhan Aksay, “Malzeme Biliminin Onderlerinden” (A leading figure in material science), *Bilim ve Teknik* (Science and Technology Magazine), TUBITAK Publishings, February 2002, p. 92.

18 Billy Goodman, “Mimicking Nature,” *Princeton Weekly*, Feature-January 28, 1998;  
<http://www.princeton.edu/~cml/html/publicity/PAW19980128/0128feat.htm>

19 Ilhan Aksay, “Malzeme Biliminin Onderlerinden” (A leading figure in material science), *Bilim ve Teknik* (Science and Technology Magazine), TUBITAK Publishings, February 2002, p. 93.

20 *Ibid.*

21 Julian Vincent, “Tricks of Nature,” *New Scientist*, August 17, 1996, vol. 151, no. 2043, p. 38.

22 Ilhan Aksay, “Malzeme Biliminin Onderlerinden” (A leading figure in material science) *Bilim ve Teknik* (Science and Technology Magazine), TUBITAK Publishings, February 2002, p. 93.

23 “Learning From Designs in Nature,” Life A product of Design; [228](http://www.watch-</a></p></div><div data-bbox=)

tower.org/library/g/2000/1/22/article\_02.htm  
24 *Ibid.*

25 Benyus, *Biomimicry*, pp. 99-100.

26 "Learning From Designs in Nature,"  
Life A product of Design; [http://www.watch-tower.org/library/g/2000/1/22/article\\_02.htm](http://www.watch-tower.org/library/g/2000/1/22/article_02.htm)

27 Julian Vincent, "Tricks of Nature,"  
*New Scientist*, August 17, 1996, vol. 151,  
no. 2043, p. 38.

28 *Ibid.*, p. 39.

29

<http://www.rdg.ac.uk/AcaDepts/cb/97hep-worth.html>

30 Julian Vincent, "Tricks of Nature,"  
*New Scientist*, August 17, 1996, vol. 151,  
no. 2043, p. 39

31 *Ibid.*, p. 40.

32 J. M. Gosline, M. E. DeMont & M. W.  
Denny, "The Structure and Properties of  
Spider Silk," *Endeavour*, Volume 10, Issue  
1, 1986, p. 42.

33 "Learning From Designs in Nature",  
Life A product of Design; [http://www.watch-tower.org/library/g/2000/1/22/article\\_02.htm](http://www.watch-tower.org/library/g/2000/1/22/article_02.htm)

34 "Spider (arthropod)," *Encarta Online  
Encyclopedia 2005*

35 J. M. Gosline, M. W. Denny & M. E.  
DeMont, "Spider silk as rubber," *Nature*,  
vol. 309, no. 5968, pp. 551-552; <http://ia-go.stfx.ca/people/edemont/abstracts/spider.html>

36 "How Spiders Make Their Silk",  
*Discover*, vol. 19, no. 10, October 1998.

37 Shear, W.A., J. M. Palmer, "A  
Devonian Spinneret: Early Evidence of  
Spiders and Silk Use," *Science*, vol. 246,  
pp. 479-481;  
[http://faculty.washington.edu/yagerp/silkpro-  
jecthome.html](http://faculty.washington.edu/yagerp/silkprojecthome.html)

38 Ali Demirsoy, *Kalitim ve Evrim*  
(Inheritance and Evolution), Meteksan  
Publishing Co., Ankara, 1984, p. 80.

39 For further details see Harun Yahya's  
*Design in Nature*, Ta Ha Publishers,  
January 2002.

40 Jim Robbins, "Engineers Ask Nature

for Design Advice," *New York Times*,  
December 11, 2001.

41 Jim Robbins, "Engineers Ask Nature  
for Design Advice," *New York Times*,  
December 11, 2001.

42 John Whitfield, "Making Crops Cry  
For Help," *Nature*, April 12, 2001, p. 736-  
737.

43 *Ibid.*

44 *Ibid.*

45 Peter Weiss, "Soaking Up Rays,"  
*Science News*, August 4, 2001.

46 *Ibid.*

47 "Learning From Designs in Nature,"  
Life A product of Design; [http://www.watch-tower.org/library/g/2000/1/22/article\\_02.htm](http://www.watch-tower.org/library/g/2000/1/22/article_02.htm)

48 Stuart Blackman, "Synchronised  
Swimming," *BBC Wildlife*, February 1998,  
p. 57.

49 Waikiki Aquarium Education  
Department, December 1998;  
[http://waquarium.mic.hawaii.edu/MLP/root/  
html/MarineLife/Invertebrates/Molluscs/Nau-  
tilus.html](http://waquarium.mic.hawaii.edu/MLP/root/html/MarineLife/Invertebrates/Molluscs/Nautilus.html)

50 "The Designing Times," vol. 1, no. 8,  
March 2000;  
[http://www.godandscience.org/evolution/de-  
sign.html](http://www.godandscience.org/evolution/design.html)

51 Philip Ball, "Astounding Bat Mobility,"  
*Nature*, February 2, 2001.

52 *Ibid.*

53 For further details see Harun Yahya's  
*Design in Nature*, Ta Ha Publishers,  
January 2002.

54 Phil Gates, *Wild Technology*, p. 52.

55 Betty Mamane, "Le surdoué du garnd  
blue," *Science et vie Junior*, August 1998,  
pp. 79-84.

56 Sonar means "Sound Navigation and  
Ranging."

57 "Yale Sonar Robot Modeled After Bat  
and Dolphin Echolocation Behavior," Yale  
University—Office of Public Affairs;  
[http://www.robotbooks.com/sonar-  
robots.htm](http://www.robotbooks.com/sonar-robots.htm)

58 "Biomimicry," Buckminster Fuller

Institute;

<http://www.bfi.org/Trimtab/spring01/bio-mimicry.htm>

59 *New Scientist*, October 14, 2000, p. 20.

60 "Kırlilige Balık Dedektörü", *Science*; trans.: Mustafa Ozturk, *Bilim ve Teknik* (Science and Technology), TUBITAK Publishings, February 1991, p. 43.

61 "Kusursuz Uçus Makineleri" (Flawless Flying Machines), *Reader's Digest*, trans.: Ruhsar Kansu, *Bilim ve Teknik* (Science and Technology), TUBITAK Publishings, no. 136, March 1979, p. 21

62 "Biomimicry," Your Planet Earth; <http://www.yourplanetearth.org/terms/details.php3?term=Biomimicry>

63 For further information see Harun Yahya's *Darwinism Refuted*, Goodword Books, New Delhi, 2003.

64 "Biyonik, Dogayı Kopya Etmektir," (Bionics Copies Nature) *Science et Vie*, trans.: Dr.Hanaslı Gur, *Bilim ve Teknik* (Science and Technology), TUBITAK Publishings, July 1985, pp. 19-20.

65 Necmi Kara, "Yakıtsız Uçus" (Fuelless Flight), *Bilim ve Teknik* (Science and Technology), TUBITAK Publishings; <http://www.biltek.tubitak.gov.tr/dergi/98/ocak/yakitsiz.html>

66 "Biyonik, Dogayı Kopya Etmektir" (Bionics Copies Nature), *Science et Vie*, trans.: Dr.Hanaslı Gur, *Bilim ve Teknik* (Science and Technology), TUBITAK Publishings, July 1985, p. 19.

67 Michael Dickinson, "Solving the Mystery of Insect Flight," *Scientific American*, June 2001.

68 *Ibid.*

69 *Ibid.*

70 Hideki Takagi, Ross Sanders, "Hydrodynamics makes a splash," *Physics World*, September 2000.

71 "Heat-seeking vipers may help with U.S. defense, UT Austin researcher finds," *On Campus*, vol.28, no.08, 27 June 2001; <http://www.utexas.edu/admin/opa/oncam->

[pus/01oc\\_issues/oc010627/oc\\_vipers.html](http://www.bfi.org/Trimtab/spring01/bio-mimicry.htm)  
72 *Ibid.*

73 *Ibid.*

74 *International Wildlife*, September-October 1992, p. 34.

75 Ann Marie Cunningham, "Clothes That Change Color," ScienCentral.Inc., [www.sciencentral.com](http://www.sciencentral.com).

76 Parker, A.R., "Light-reflection strategies," *American Scientist* (1999a) 87 (3), 248-255; <http://www.rdg.ac.uk/Biomim/00parker.htm>

77 Parker, A. R., "Water capture by a desert beetle," *Nature* 414, 2001, pp. 33-34.

78 *Ibid.*

79 Stuart Blackman, "Fatal Flasher," *BBC Wildlife*, April 1998, vol.16, no.4, p. 60.

80

<http://www.milliyet.com.tr/2001/07/31/yasam/yas07.html>

81 Eiji Nakatsu, "Learning From Nature - A Flight of Wild Birds and Railways," [http://www.wbsj.org/birdwatching/contribution/97\\_910e.html](http://www.wbsj.org/birdwatching/contribution/97_910e.html)

82 *Ibid.*

83 "Biomimicry", Buckminster Fuller Institute; <http://www.bfi.org/Trimtab/spring01/bio-mimicry.htm>

84 Ilan Greenberg, "Butterflies Show Path to Cooler Chips," *Wired News*, <http://wired-vig.wired.com/news/technology/0,1282,10163,00.html>.

85 "New standard set for scientific visualizations", Sandia National Laboratories, *News Releases*, July 12, 2001; <http://www.sandia.gov/media/NewsRel/NR2001/vizcor.htm>

86 Robert Kunzig, "The Beat Goes On," *Discover*, January 2000.

87 *Ibid.*

88 *Ibid.*

89 *Ibid.*

90 "The Internet strikes back," *New*

*Scientist*, May 24, 1997.

91 Phil Gates, *Wild Technology*, p. 54.

92 David H. Hubbel, *Eye Brain and Vision*, Scientific American Library, 1988, p. 34.

93 Jim Giles, "Think Like A Bee," *Nature*, March 29, 2001, pp. 510-512.

94 *Ibid.*

95 "SWAT'z new?—fly that's setting the hearing world abuzz", NIDCD, February 13, 2003; <http://www.nidcd.nih.gov/health/education/news/swatz.asp>

96 Peter M. Narins, "Acoustics: In a Fly's Ear," *Nature* 410, 2001, pp. 644-645.

97 "Biyonik, Dogayı Kopya Etmektir" (Bionics Copies Nature), *Science et Vie*, trans.: Dr. Hanaslı Gur, *Bilim ve Teknik* (Science and Technology), TUBITAK Publishings, July 1985, p. 21.

98 Smithsonian National Zoological Park; [http://www.fonz.org/zoogoer/zg1999/28\(4\)b iomimetics.htm](http://www.fonz.org/zoogoer/zg1999/28(4)b iomimetics.htm)

99 David Attenborough, *The Private Life Of Plants*, Princeton University Press, 1995, p. 291.

100 Smithsonian National Zoological Park; [http://www.fonz.org/zoogoer/zg1999/28\(4\)b iomimetics.htm](http://www.fonz.org/zoogoer/zg1999/28(4)b iomimetics.htm)

101 "Biyonik, Dogayı Kopya Etmektir," (Bionics Copies Nature) *Science et Vie*, trans.: Dr. Hanaslı Gur, *Bilim ve Teknik* (Science and Technology), TUBITAK Publishings, July 1985, p. 21.

102 Erica Klarreich, "Good vibrations," *Nature Science Update*, April 3, 2001.

103 Joseph Ayers, Joel L. Davis and Alan Rudolph, "Neurotechnology for Biomimetic Robots;" <http://mitpress.mit.edu/catalog/item/default.asp?sid=059CE164-6183-4410-8320-D5828734B95A&ttype=2&tid=8812>

104 For further information see Harun Yahya's *For Men of Understanding*, Ta Ha

Publishers, April 2003.

105 Kevin Bonsor, "How Snakebots will Work," Howstuffworks; <http://www.howstuffworks.com/snakebot.htm>

106 Duncan Graham-Rowe, "Walk like a scorpion," *NewScientist*; 21 April 2001.

107 "Biological Analysis," AIS Approach; <http://ais.gmd.de/BAR/SCORPION/biology.htm>

108 *Ibid.*

109 Duncan Graham-Rowe, "Walk like a scorpion," *NewScientist*; 21 April 2001.

110 Yvonne Carls-Powell, "Robots mimic living creatures," *OE Reports*; <http://www.spie.org/web/oer/september/sep00/cover1.html>

111 *Ibid.*

112 *Ibid.*

113 Robert Sanders, "Lobster sniffing: how lobsters' hairy noses capture smells from the sea," *UC Berkeley Campus News*, November 30, 2001; [http://www.berkeley.edu/news/media/releases/2001/11/30\\_lobst.html](http://www.berkeley.edu/news/media/releases/2001/11/30_lobst.html)

114 *Ibid.*

115 Projects at the Centre for Biomimetics; <http://www.rdg.ac.uk/Biomim/projects.htm>

116 *BBC News Online*, June 7, 2000; [http://news.bbc.co.uk/low/english/sci/tech/newsid\\_781000/781611.htm](http://news.bbc.co.uk/low/english/sci/tech/newsid_781000/781611.htm)

117 *World Wealth International*, vol. 1, no. 1, February 2001; <http://www.world-wealth.net/samplemag/ArticleGeckoPrint.html>

118 Fenella Saunders, "Robo-Geckos," *Discover*, September 2000, vol. 21, no. 9

119 *Ibid.*

120 *Ibid.*

121 *Ibid.*

122 *Ibid.*

123 Phil Gates, *Wild Technology*, p. 5.

124 *Ibid.*, p. 55.

125 *Ibid.*, p. 64.

126 *Ibid.*, p. 67.

127 "Biomimicry", *Your Planet Earth*

Glossary 1.0.1; <http://www.yourplanetearth.org/terms/details.php3?term=Biomicry>

128 Phil Gates, *Wild Technology*, p. 65.

129 For further information see Harun Yahya's *For Men of Understanding*, Ta Ha Publishers, April 2003.

130 Phil Gates, *Wild Technology*, p. 66.

131 <http://www.bitkidunyasi.net/ilgincbitkiler/ilgincbitkiler1.html>

132 Phil Gates, *Wild Technology*, p. 67.

133 Animal Inventors, *National Geographic Channel* (Turkey), November 25, 2001.

134 Phil Gates, *Wild Technology*, p. 16.

135 Richard Dawkins, *Climbing Mount Improbable*, W.W. Norton & Company, September 1996, p. 92.

136 "The Elephant's Trunk Robotic Arm;" <http://ece.clemson.edu/crb/labs/biomimetic/elephant.htm>

137 Sidney Fox, Klaus Dose, *Molecular Evolution and The Origin of Life*, W.H. Freeman and Company, San Francisco, 1972, p. 4.

138 Alexander I. Oparin, *Origin of Life*, Dover Publications, New York, 1936, 1953 (reprint), p. 196.

139 "New Evidence on Evolution of Early Atmosphere and Life", *Bulletin of the American Meteorological Society*, vol 63, November 1982, 1328-1330.

140 Stanley Miller, *Molecular Evolution of Life: Current Status of the Prebiotic Synthesis of Small Molecules*, 1986, p. 7.

141 Jeffrey Bada, *Earth*, February 1998, p. 40.

142 Leslie E. Orgel, "The Origin of Life on Earth", *Scientific American*, vol. 271, October 1994, p. 78.

143 Charles Darwin, *The Origin of Species by Means of Natural Selection*, The Modern Library, New York, p. 127.

144 Charles Darwin, *The Origin of Species: A Facsimile of the First Edition*, Harvard University Press, 1964, p. 184.

145 B. G. Ranganathan, *Origins?*, Pennsylvania: The Banner Of Truth Trust, 1988, p. 7.

146 Darwin, *The Origin of Species: A Facsimile of the First Edition*, p. 179.

147 Derek A. Ager, "The Nature of the Fossil Record," *Proceedings of the British Geological Association*, vol 87, 1976, p. 133.

148 Douglas J. Futuyma, *Science on Trial*, Pantheon Books, New York, 1983, p. 197.

149 Solly Zuckerman, *Beyond The Ivory Tower*, Toplinger Publications, New York, 1970, pp. 75-14; Charles E. Oxnard, "The Place of Australopithecines in Human Evolution: Grounds for Doubt," *Nature*, vol 258, p. 389.

150 "Could science be brought to an end by scientists' belief that they have final answers or by society's reluctance to pay the bills?" *Scientific American*, December 1992, p. 20.

151 Alan Walker, *Science*, vol. 207, 7 March 1980, p. 1103; A. J. Kelso, *Physical Anthropology*, 1st ed., J. B. Lipincott Co., New York, 1970, p. 221; M. D. Leakey, *Olduvai Gorge*, vol. 3, Cambridge University Press, Cambridge, 1971, p. 272.

152 Jeffrey Kluger, "Not So Extinct After All: The Primitive Homo Erectus May Have Survived Long Enough To Coexist With Modern Humans", *Time*, 23 December 1996.

153 S. J. Gould, *Natural History*, vol. 85, 1976, p. 30.

154 Zuckerman, *Beyond The Ivory Tower*, p. 19.

155 Richard Lewontin, "The Demon-Haunted World," *The New York Review of Books*, January 9, 1997, p. 28.

156 Malcolm Muggeridge, *The End of Christendom*, Grand Rapids:Eerdmans, 1980, p. 43.



## ABOUT THE AUTHOR

Now writing under the pen-name of HARUN YAHYA, he was born in Ankara in 1956. Having completed his primary and secondary education in Ankara, he studied arts at Istanbul's Mimar Sinan University and philosophy at Istanbul University. Since the 1980s, he has published many books on political, scientific, and faith-related issues. Harun Yahya is well-known as the author of important works disclosing the imposture of evolutionists, their invalid claims, and the dark liaisons between Darwinism and such bloody ideologies as fascism and communism.

Harun Yahya's works, translated into 41 different languages, constitute a collection for a total of more than 45,000 pages with 30,000 illustrations.

His pen-name is a composite of the names Harun (Aaron) and Yahya (John), in memory of the two esteemed prophets who fought against their people's lack of faith. The Prophet's seal on his books' covers is symbolic and is linked to their contents. It represents the Qur'an (the Final Scripture) and Prophet Muhammad (may God bless him and grant him peace), last of the prophets. Under the guidance of the Qur'an and the Sunnah (teachings of the Prophet), the author makes it his purpose to disprove each fundamental tenet of godless ideologies and to have the "last word," so as to completely silence the objections raised against religion. He uses the seal of the final Prophet (may God bless him and grant him peace), who attained ultimate wisdom and moral perfection, as a sign of his intention to offer the last word.

All of Harun Yahya's works share one single goal: to convey the Qur'an's message, encourage readers to consider basic faith-related issues such as God's existence and unity and the Hereafter; and to expose godless systems' feeble foundations and perverted ideologies.

Harun Yahya enjoys a wide readership in many countries, from India to America, England to Indonesia, Poland to Bosnia, Spain to Brazil, Malaysia to Italy, France to Bulgaria and Russia. Some of his books are available in English, French, German, Spanish, Italian, Portuguese, Urdu, Arabic, Albanian, Chinese, Swahili, Hausa, Dhivehi (spo-



ken in Mauritius), Russian, Serbo-Croat (Bosnian), Polish, Malay, Uygur Turkish, Indonesian, Bengali, Danish and Swedish.

Greatly appreciated all around the world, these works have been instrumental in many people recovering faith in God and gaining deeper insights into their faith. His books' wisdom and sincerity, together with a distinct style that's easy to understand, directly affect anyone who reads them. Those who seriously consider these books, can no longer advocate atheism or any other perverted ideology or materialistic philosophy, since these books are characterized by rapid effectiveness, definite results, and irrefutability. Even if they continue to do so, it will be only a sentimental insistence, since these books refute such ideologies from their very foundations. All contemporary movements of denial are now ideologically defeated, thanks to the books written by Harun Yahya.

This is no doubt a result of the Qur'an's wisdom and lucidity. The author modestly intends to serve as a means in humanity's search for God's right path. No material gain is sought in the publication of these works.

Those who encourage others to read these books, to open their minds and hearts and guide them to become more devoted servants of God, render an invaluable service.

Meanwhile, it would only be a waste of time and energy to propagate other books that create confusion in people's minds, lead them into ideological chaos, and that clearly have no strong and precise effects in removing the doubts in people's hearts, as also verified from previous experience. It is impossible for books devised to emphasize the author's literary power rather than the noble goal of saving people from loss of faith, to have such a great effect. Those who doubt this can readily see that the sole aim of Harun Yahya's books is to overcome disbelief and to disseminate the Qur'an's moral values. The success and impact of this service are manifested in the readers' conviction.

One point should be kept in mind: The main reason for the continuing cruelty, conflict, and other ordeals endured by the vast majority of people is the ideological prevalence of disbelief. This can be ended only with the ideological defeat of disbelief and by conveying the wonders of creation and Qur'anic morality so that people can live by it. Considering the state of the world today, leading into a downward spiral of violence, corruption and conflict, clearly this service must be provided speedily and effectively, or it may be too late.

In this effort, the books of Harun Yahya assume a leading role. By the will of God, these books will be a means through which people in the twenty-first century will attain the peace, justice, and happiness promised in the Qur'an.