

# **Complete Solutions to Selected Problems**

*to accompany*

---

## **MATERIALS SCIENCE AND ENGINEERING**

### **AN INTRODUCTION**

**Sixth Edition**

---

**William D. Callister, Jr.**  
The University of Utah



**John Wiley & Sons, Inc.**

Copyright © 2003 John Wiley & Sons, Inc. All rights reserved.

No part of this publication may be reproduced, stored in a retrieval system or transmitted in any form or by any means, electronic, mechanical, photocopying, recording, scanning or otherwise, except as permitted under Sections 107 or 108 of the 1976 United States Copyright Act, without either the prior written permission of the Publisher, or authorization through payment of the appropriate per-copy fee to the Copyright Clearance Center, 222 Rosewood Drive, Danvers, MA 01923, (508)750-8400, fax (508)750-4470. Requests to the Publisher for permission should be addressed to the Permissions Department, John Wiley & Sons, Inc., 605 Third Avenue, New York, NY 10158-0012, (212) 850-6011, fax (212) 850-6008, E-Mail: [PERMREQ@WILEY.COM](mailto:PERMREQ@WILEY.COM).

To order books or for customer service please call 1(800)225-5945.

# SOLUTIONS TO PROBLEMS

## PREFACE

This section of instructor's resource materials contains solutions and answers to all problems and questions that appear in the textbook. My penmanship leaves something to be desired; therefore, I generated these solutions/answers using computer software so that the resulting product would be "readable." Furthermore, I endeavored to provide complete and detailed solutions in order that: (1) the instructor, without having to take time to solve a problem, will understand what principles/skills are to be learned by its solution; and (2) to facilitate student understanding/learning when the solution is posted.

I would recommend that the course instructor consult these solutions/answers before assigning problems and questions. In doing so, he or she ensures that the students will be drilled in the intended principles and concepts. In addition, the instructor may provide appropriate hints for some of the more difficult problems.

With regard to symbols, in the text material I elected to boldface those symbols that are italicized in the textbook. Furthermore, I also endeavored to be consistent relative to symbol style. However, in several instances, symbols that appear in the textbook were not available, and it was necessary to make appropriate substitutions. These include the following: the letter **a** (unit cell edge length, crack length) is used in place of the cursive *a*. And Roman **E** and **F** replace script *E* (electric field in Chapter 18) and script *F* (Faraday's constant in Chapter 17), respectively.

I have exercised extreme care in designing these problems/questions, and then in solving them. However, no matter how careful one is with the preparation of a work such as this, errors will always remain in the final product. Therefore, corrections, suggestions, and comments from instructors who use the textbook (as well as their teaching assistants) pertaining to homework problems/solutions are welcomed. These may be sent to me in care of the publisher.

## CHAPTER 2

### ATOMIC STRUCTURE AND INTERATOMIC BONDING

#### PROBLEM SOLUTIONS

2.1 (a) When two or more atoms of an element have different atomic masses, each is termed an **isotope**.

(b) The atomic weights of the elements ordinarily are not integers because: (1) the atomic masses of the atoms generally are not integers (except for  $^{12}\text{C}$ ), and (2) the atomic weight is taken as the weighted average of the atomic masses of an atom's naturally occurring isotopes.

2.2 Atomic mass is the mass of an individual atom, whereas atomic weight is the average (weighted) of the atomic masses of an atom's naturally occurring isotopes.

2.3 (a) In order to determine the number of grams in one amu of material, appropriate manipulation of the amu/atom, g/mol, and atom/mol relationships is all that is necessary, as

$$\begin{aligned}\# \text{ g/amu} &= \left( \frac{1 \text{ mol}}{6.023 \times 10^{23} \text{ atoms}} \right) \left( \frac{1 \text{ g/mol}}{1 \text{ amu/atom}} \right) \\ &= 1.66 \times 10^{-24} \text{ g/amu}\end{aligned}$$

(b) Since there are 453.6 g/lb<sub>m</sub>,

$$\begin{aligned}1 \text{ lb - mol} &= (453.6 \text{ g/lb}_m) (6.023 \times 10^{23} \text{ atoms/g - mol}) \\ &= 2.73 \times 10^{26} \text{ atoms/lb-mol}\end{aligned}$$

2.4 (a) Two important quantum-mechanical concepts associated with the Bohr model of the atom are that electrons are particles moving in discrete orbitals, and electron energy is quantized into shells.

(b) Two important refinements resulting from the wave-mechanical atomic model are that electron position is described in terms of a probability distribution, and electron energy is quantized into both shells and subshells--each electron is characterized by four quantum numbers.

2.5 The **n** quantum number designates the electron shell.

The **l** quantum number designates the electron subshell.

The **m<sub>l</sub>** quantum number designates the number of electron states in each electron subshell.

The **m<sub>s</sub>** quantum number designates the spin moment on each electron.

2.6 For the **L** state, **n** = 2, and eight electron states are possible. Possible **l** values are 0 and 1, while possible **m<sub>l</sub>** values are 0 and  $\pm 1$ . Therefore, for the **s** states, the quantum numbers are  $200(\frac{1}{2})$  and  $200(-\frac{1}{2})$ . For the **p** states, the quantum numbers are  $210(\frac{1}{2})$ ,  $210(-\frac{1}{2})$ ,  $211(\frac{1}{2})$ ,  $211(-\frac{1}{2})$ ,  $21(-1)(\frac{1}{2})$ , and  $21(-1)(-\frac{1}{2})$ .

For the **M** state, **n** = 3, and 18 states are possible. Possible **l** values are 0, 1, and 2; possible **m<sub>l</sub>** values are 0,  $\pm 1$ , and  $\pm 2$ ; and possible **m<sub>s</sub>** values are  $\pm \frac{1}{2}$ . Therefore, for the **s** states, the quantum numbers are  $300(\frac{1}{2})$ ,  $300(-\frac{1}{2})$ , for the **p** states they are  $310(\frac{1}{2})$ ,  $310(-\frac{1}{2})$ ,  $311(\frac{1}{2})$ ,  $311(-\frac{1}{2})$ ,  $31(-1)(\frac{1}{2})$ , and  $31(-1)(-\frac{1}{2})$ ; for the **d** states they are  $320(\frac{1}{2})$ ,  $320(-\frac{1}{2})$ ,  $321(\frac{1}{2})$ ,  $321(-\frac{1}{2})$ ,  $32(-1)(\frac{1}{2})$ ,  $32(-1)(-\frac{1}{2})$ ,  $322(\frac{1}{2})$ ,  $322(-\frac{1}{2})$ ,  $32(-2)(\frac{1}{2})$ , and  $32(-2)(-\frac{1}{2})$ .

2.7 The electron configurations of the ions are determined using Table 2.2.

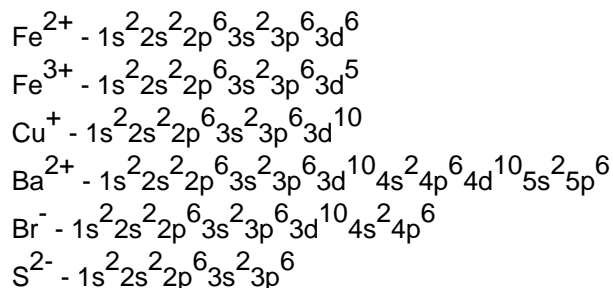

2.8 The  $\text{Na}^+$  ion is just a sodium atom that has lost one electron; therefore, it has an electron configuration the same as neon (Figure 2.6).

The  $\text{Cl}^-$  ion is a chlorine atom that has acquired one extra electron; therefore, it has an electron configuration the same as argon.

2.9 Each of the elements in Group IIA has two **s** electrons.

2.10 (a) The  $1s^2 2s^2 2p^6 3s^2 3p^6 3d^7 4s^2$  electron configuration is that of a transition metal because of an incomplete **d** subshell.

- (b) The  $1s^2 2s^2 2p^6 3s^2 3p^6$  electron configuration is that of an inert gas because of filled **3s** and **3p** subshells.
- (c) The  $1s^2 2s^2 2p^5$  electron configuration is that of a halogen because it is one electron deficient from having a filled **L** shell.
- (d) The  $1s^2 2s^2 2p^6 3s^2$  electron configuration is that of an alkaline earth metal because of two **s** electrons.
- (e) The  $1s^2 2s^2 2p^6 3s^2 3p^6 3d^2 4s^2$  electron configuration is that of a transition metal because of an incomplete **d** subshell.
- (f) The  $1s^2 2s^2 2p^6 3s^2 3p^6 4s^1$  electron configuration is that of an alkali metal because of a single **s** electron.

2.11 (a) The **4f** subshell is being filled for the rare earth series of elements.

(b) The **5f** subshell is being filled for the actinide series of elements.

2.12 The attractive force between two ions  $F_A$  is just the derivative with respect to the interatomic separation of the attractive energy expression, Equation (2.8), which is just

$$F_A = \frac{dE_A}{dr} = \frac{d\left(-\frac{A}{r}\right)}{dr} = \frac{A}{r^2}$$

The constant **A** in this expression is defined in footnote 3. Since the valences of the  $\text{Ca}^{2+}$  and  $\text{O}^{2-}$  ions ( $Z_1$  and  $Z_2$ ) are both 2, then

$$\begin{aligned} F_A &= \frac{(Z_1 e)(Z_2 e)}{4\pi\epsilon_0 r^2} \\ &= \frac{(2)(2)(1.6 \times 10^{-19} \text{ C})^2}{(4)(\pi)(8.85 \times 10^{-12} \text{ F/m})(1.25 \times 10^{-9} \text{ m})^2} \\ &= 5.89 \times 10^{-10} \text{ N} \end{aligned}$$

2.13 (a) Differentiation of Equation (2.11) yields

$$\frac{dE_N}{dr} = \frac{A}{r^{(1+1)}} - \frac{nB}{r^{(n+1)}} = 0$$

(b) Now, solving for  $r (= r_o)$

$$\frac{A}{r_o^2} = \frac{nB}{r_o^{(n+1)}}$$

or

$$r_o = \left( \frac{A}{nB} \right)^{1/(1-n)}$$

(c) Substitution for  $r_o$  into Equation (2.11) and solving for  $E (= E_o)$

$$\begin{aligned} E_o &= -\frac{A}{r_o} + \frac{B}{r_o^n} \\ &= -\frac{A}{\left( \frac{A}{nB} \right)^{1/(1-n)}} + \frac{B}{\left( \frac{A}{nB} \right)^{n/(1-n)}} \end{aligned}$$

2.14 (a) Curves of  $E_A$ ,  $E_R$ , and  $E_N$  are shown on the plot below.

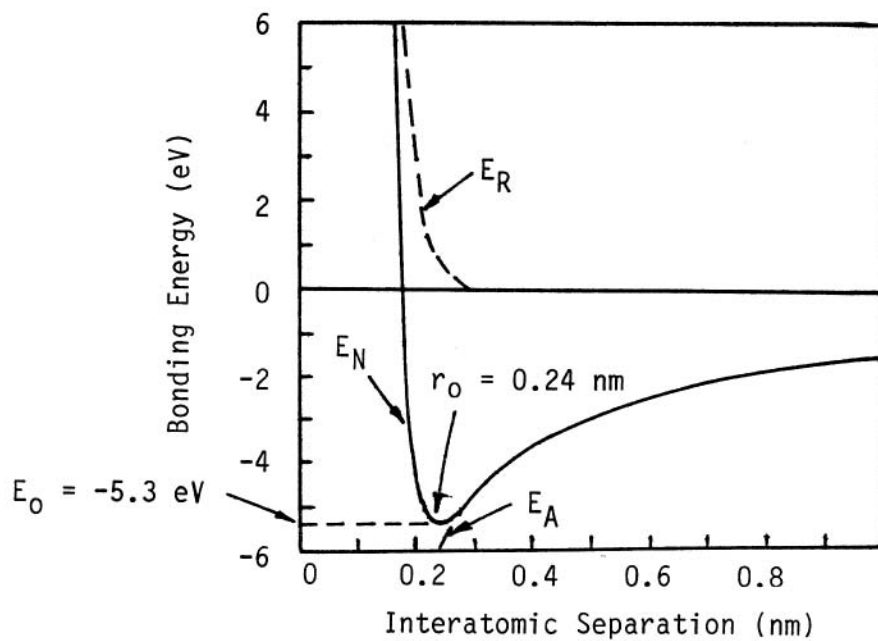

(b) From this plot

$$r_o = 0.24 \text{ nm}$$

$$E_o = -5.3 \text{ eV}$$

(c) From Equation (2.11) for  $E_N$

$$A = 1.436$$

$$B = 7.32 \times 10^{-6}$$

$$n = 8$$

Thus,

$$r_o = \left( \frac{A}{nB} \right)^{1/(1-n)}$$

$$= \left[ \frac{1.436}{(8)(7.32 \times 10^{-6})} \right]^{-1/(1-8)} = 0.236 \text{ nm}$$

and

$$E_o = - \frac{1.436}{\left[ \frac{1.436}{(8)(7.32 \times 10^{-6})} \right]^{1/(1-8)}} + \frac{7.32 \times 10^{-6}}{\left[ \frac{1.436}{(8)(7.32 \times 10^{-6})} \right]^{8/(1-8)}}$$

$$= - 5.32 \text{ eV}$$

2.15 This problem gives us, for a hypothetical  $X^+Y^-$  ion pair, values for  $r_o$  (0.35 nm),  $E_o$  (-6.13 eV), and  $n$  (10), and asks that we determine explicit expressions for attractive and repulsive energies of Equations 2.8 and 2.9. In essence, it is necessary to compute the values of  $A$  and  $B$  in these equations. Expressions for  $r_o$  and  $E_o$  in terms of  $n$ ,  $A$ , and  $B$  were determined in Problem 2.13, which are as follows:

$$r_o = \left( \frac{A}{nB} \right)^{1/(1-n)}$$



$$E_o = -\frac{A}{\left(\frac{A}{nB}\right)^{1/(1-n)}} + \frac{B}{\left(\frac{A}{nB}\right)^{n/(1-n)}}$$

Thus, we have two simultaneous equations with two unknowns (viz. **A** and **B**). Upon substitution of values for  $r_o$  and  $E_o$  in terms of **n**, these equations take the forms

$$0.35 \text{ nm} = \left(\frac{A}{10B}\right)^{1/(1-10)}$$

$$-6.13 \text{ eV} = -\frac{A}{\left(\frac{A}{10B}\right)^{1/(1-10)}} + \frac{B}{\left(\frac{A}{10B}\right)^{10/(1-10)}}$$

Simultaneous solution of these two equations leads to **A** = 2.38 and **B** =  $1.88 \times 10^{-5}$ . Thus, Equations (2.8) and (2.9) become

$$E_A = -\frac{2.38}{r}$$

$$E_R = \frac{1.88 \times 10^{-5}}{r^{10}}$$

Of course these expressions are valid for **r** and **E** in units of nanometers and electron volts, respectively.

2.16 (a) Differentiating Equation (2.12) with respect to **r** yields

$$\frac{dE}{dr} = \frac{C}{r^2} - \frac{De^{-r/\rho}}{\rho}$$

At  $r = r_o$ ,  $dE/dr = 0$ , and

$$\frac{C}{r_o^2} = \frac{De^{-(r_o/\rho)}}{\rho} \quad (2.12b)$$

Solving for **C** and substitution into Equation (2.12) yields an expression for  $E_o$  as

$$E_o = D e^{-(r_o/\rho)} \left( 1 - \frac{r_o}{\rho} \right)$$

(b) Now solving for **D** from Equation (2.12b) above yields

$$D = \frac{C \rho e^{(r_o/\rho)}}{r_o^2}$$

Substitution of this expression for **D** into Equation (2.12) yields an expression for **E<sub>o</sub>** as

$$E_o = \frac{C}{r_o} \left( \frac{\rho}{r_o} - 1 \right)$$

2.17 (a) The main differences between the various forms of primary bonding are:

**Ionic**--there is electrostatic attraction between oppositely charged ions.

**Covalent**--there is electron sharing between two adjacent atoms such that each atom assumes a stable electron configuration.

**Metallic**--the positively charged ion cores are shielded from one another, and also "glued" together by the sea of valence electrons.

(b) The Pauli exclusion principle states that each electron state can hold no more than two electrons, which must have opposite spins.

2.18 Covalently bonded materials are less dense than metallic or ionically bonded ones because covalent bonds are directional in nature whereas metallic and ionic are not; when bonds are directional, the atoms cannot pack together in as dense a manner, yielding a lower mass density.

2.19 The percent ionic character is a function of the electron negativities of the ions **X<sub>A</sub>** and **X<sub>B</sub>** according to Equation (2.10). The electronegativities of the elements are found in Figure 2.7.

For MgO, **X<sub>Mg</sub>** = 1.2 and **X<sub>O</sub>** = 3.5, and therefore,

$$\%IC = \left[ 1 - e^{(-0.25)(3.5-1.2)^2} \right] \times 100 = 73.4\%$$

For GaP, **X<sub>Ga</sub>** = 1.6 and **X<sub>P</sub>** = 2.1, and therefore,

$$\%IC = \left[ 1 - e^{(-0.25)(2.1-1.6)^2} \right] \times 100 = 6.1\%$$

For CsF,  $X_{Cs} = 0.7$  and  $X_F = 4.0$ , and therefore,

$$\%IC = \left[ 1 - e^{(-0.25)(4.0-0.7)^2} \right] \times 100 = 93.4\%$$

For CdS,  $X_{Cd} = 1.7$  and  $X_S = 2.5$ , and therefore,

$$\%IC = \left[ 1 - e^{(-0.25)(2.5-1.7)^2} \right] \times 100 = 14.8\%$$

For FeO,  $X_{Fe} = 1.8$  and  $X_O = 3.5$ , and therefore,

$$\%IC = \left[ 1 - e^{(-0.25)(3.5-1.8)^2} \right] \times 100 = 51.4\%$$

2.20 Below is plotted the bonding energy versus melting temperature for these four metals. From this plot, the bonding energy for copper (melting temperature of 1084°C) should be approximately 3.6 eV. The experimental value is 3.5 eV.

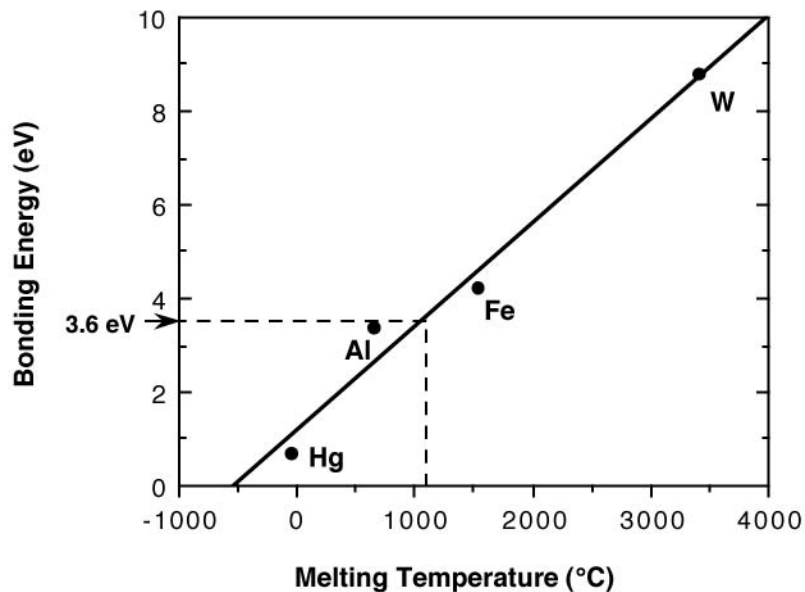

2.21 For silicon, having the valence electron structure  $3s^2 3p^2$ ,  $N' = 4$ ; thus, there are  $8 - N' = 4$  covalent bonds per atom.

For bromine, having the valence electron structure  $4s^2 4p^5$ ,  $N' = 7$ ; thus, there is  $8 - N' = 1$  covalent bond per atom.

For nitrogen, having the valence electron structure  $2s^2 2p^3$ ,  $N' = 5$ ; thus, there are  $8 - N' = 3$  covalent bonds per atom.

For sulfur, having the valence electron structure  $3s^2 3p^4$ ,  $N' = 6$ ; thus, there are  $8 - N' = 2$  covalent bonds per atom.

2.22 For brass, the bonding is metallic since it is a metal alloy.

For rubber, the bonding is covalent with some van der Waals. (Rubber is composed primarily of carbon and hydrogen atoms.)

For BaS, the bonding is predominantly ionic (but with some covalent character) on the basis of the relative positions of Ba and S in the periodic table.

For solid xenon, the bonding is van der Waals since xenon is an inert gas.

For bronze, the bonding is metallic since it is a metal alloy (composed of copper and tin).

For nylon, the bonding is covalent with perhaps some van der Waals. (Nylon is composed primarily of carbon and hydrogen.)

For AlP the bonding is predominantly covalent (but with some ionic character) on the basis of the relative positions of Al and P in the periodic table.

2.23 The intermolecular bonding for HF is hydrogen, whereas for HCl, the intermolecular bonding is van der Waals. Since the hydrogen bond is stronger than van der Waals, HF will have a higher melting temperature.

2.24 The geometry of the  $H_2O$  molecules, which are hydrogen bonded to one another, is more restricted in the solid phase than for the liquid. This results in a more open molecular structure in the solid, and a less dense solid phase.

## CHAPTER 3

### THE STRUCTURE OF CRYSTALLINE SOLIDS

#### PROBLEM SOLUTIONS

3.1 Atomic structure relates to the number of protons and neutrons in the nucleus of an atom, as well as the number and probability distributions of the constituent electrons. On the other hand, crystal structure pertains to the arrangement of atoms in the crystalline solid material.

3.2 A crystal structure is described by both the geometry of, and atomic arrangements within, the unit cell, whereas a crystal system is described only in terms of the unit cell geometry. For example, face-centered cubic and body-centered cubic are crystal structures that belong to the cubic crystal system.

3.3 For this problem, we are asked to calculate the volume of a unit cell of aluminum. Aluminum has an FCC crystal structure (Table 3.1). The FCC unit cell volume may be computed from Equation (3.4) as

$$V_C = 16R^3\sqrt{2} = (16)(0.143 \times 10^{-9} \text{ m})^3\sqrt{2} = 6.62 \times 10^{-29} \text{ m}^3$$

3.4 This problem calls for a demonstration of the relationship  $a = 4R\sqrt{3}$  for BCC. Consider the BCC unit cell shown below

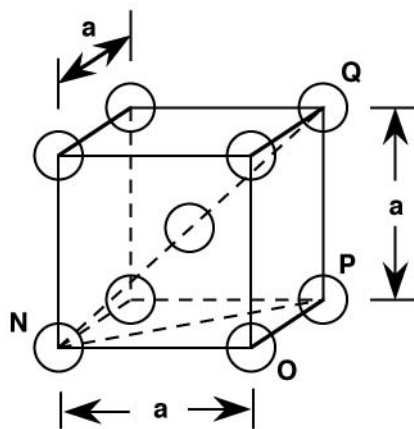

Using the triangle **NOP**

$$(\overline{NP})^2 = a^2 + a^2 = 2a^2$$

And then for triangle **NPQ**,

$$(\overline{NQ})^2 = (\overline{QP})^2 + (\overline{NP})^2$$

But  $\overline{NQ} = 4R$ , **R** being the atomic radius. Also,  $\overline{QP} = a$ . Therefore,

$$(4R)^2 = a^2 + 2a^2, \text{ or}$$

$$a = \frac{4R}{\sqrt{3}}$$

3.5 We are asked to show that the ideal **c/a** ratio for HCP is 1.633. A sketch of one-third of an HCP unit cell is shown below.

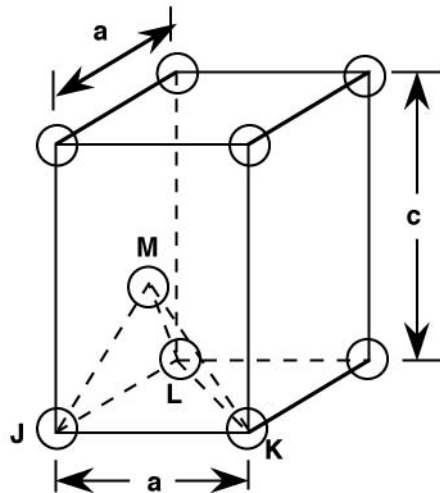

Consider the tetrahedron labeled as **JKLM**, which is reconstructed as

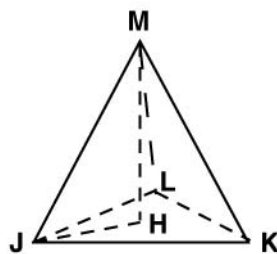

The atom at point **M** is midway between the top and bottom faces of the unit cell--that is  $\overline{MH} = c/2$ . And, since atoms at points **J**, **K**, and **M**, all touch one another,

$$\overline{JM} = \overline{JK} = 2R = a$$

where **R** is the atomic radius. Furthermore, from triangle **JHM**,

$$(\overline{JM})^2 = (\overline{JH})^2 + (\overline{MH})^2, \text{ or}$$

$$a^2 = (\overline{JH})^2 + \left(\frac{c}{2}\right)^2$$

Now, we can determine the  $\overline{JH}$  length by consideration of triangle **JKL**, which is an equilateral triangle,

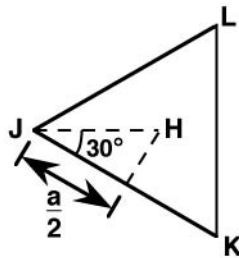

$$\cos 30^\circ = \frac{a/2}{JH} = \frac{\sqrt{3}}{2}, \text{ and}$$

$$\overline{JH} = \frac{a}{\sqrt{3}}$$

Substituting this value for  $\overline{JH}$  in the above expression yields

$$a^2 = \left(\frac{a}{\sqrt{3}}\right)^2 + \left(\frac{c}{2}\right)^2 = \frac{a^2}{3} + \frac{c^2}{4}$$

and, solving for **c/a**

$$\frac{c}{a} = \sqrt{\frac{8}{3}} = 1.633$$

3.6 We are asked to show that the atomic packing factor for BCC is 0.68. The atomic packing factor is defined as the ratio of sphere volume to the total unit cell volume, or

$$APF = \frac{V_S}{V_C}$$

Since there are two spheres associated with each unit cell for BCC

$$V_S = 2(\text{sphere volume}) = 2\left(\frac{4\pi R^3}{3}\right) = \frac{8\pi R^3}{3}$$

Also, the unit cell has cubic symmetry, that is  $V_C = a^3$ . But  $a$  depends on  $R$  according to Equation (3.3), and

$$V_C = \left(\frac{4R}{\sqrt{3}}\right)^3 = \frac{64R^3}{3\sqrt{3}}$$

Thus,

$$APF = \frac{8\pi R^3/3}{64R^3/3\sqrt{3}} = 0.68$$

3.7 This problem calls for a demonstration that the **APF** for HCP is 0.74. Again, the **APF** is just the total sphere-unit cell volume ratio. For HCP, there are the equivalent of six spheres per unit cell, and thus

$$V_S = 6\left(\frac{4\pi R^3}{3}\right) = 8\pi R^3$$

Now, the unit cell volume is just the product of the base area times the cell height,  $c$ . This base area is just three times the area of the parallelepiped **ACDE** shown below.



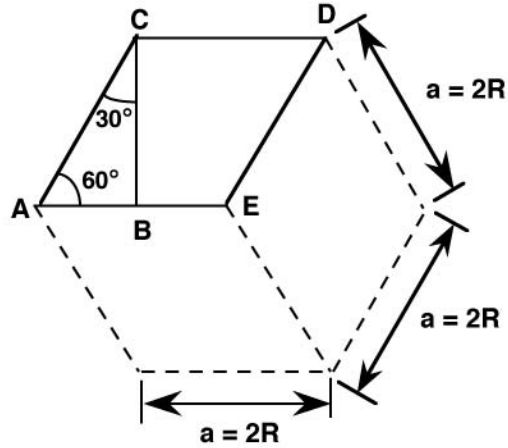

The area of **ACDE** is just the length of  $\overline{CD}$  times the height  $\overline{BC}$ . But  $\overline{CD}$  is just  $a$  or  $2R$ , and

$$\overline{BC} = 2R \cos(30^\circ) = \frac{2R\sqrt{3}}{2}$$

Thus, the base area is just

$$\text{AREA} = (3)(\overline{CD})(\overline{BC}) = (3)(2R)\left(\frac{2R\sqrt{3}}{2}\right) = 6R^2\sqrt{3}$$

and since  $c = 1.633a = 2R(1.633)$

$$V_C = (\text{AREA})(c) = 6R^2c\sqrt{3} = (6R^2\sqrt{3})(2)(1.633)R = 12\sqrt{3}(1.633)R^3$$

Thus,

$$\text{APF} = \frac{V_S}{V_C} = \frac{8\pi R^3}{12\sqrt{3}(1.633)R^3} = 0.74$$

3.8 This problem calls for a computation of the density of iron. According to Equation (3.5)

$$\rho = \frac{nA_{\text{Fe}}}{V_C N_A}$$

For BCC,  $n = 2$  atoms/unit cell, and

$$V_C = \left(\frac{4R}{\sqrt{3}}\right)^3$$

Thus,

$$\rho = \frac{(2 \text{ atoms/unit cell})(55.9 \text{ g/mol})}{\left\{ \left[ (4) \left( 0.124 \times 10^{-7} \text{ cm} \right)^3 / \sqrt{3} \right]^3 / (\text{unit cell}) \right\} (6.023 \times 10^{23} \text{ atoms/mol})}$$

$$= 7.90 \text{ g/cm}^3$$

The value given inside the front cover is  $7.87 \text{ g/cm}^3$ .

- 3.9 We are asked to determine the radius of an iridium atom, given that Ir has an FCC crystal structure. For FCC,  $n = 4$  atoms/unit cell, and  $V_C = 16R^3\sqrt{2}$  [Equation (3.4)]. Now,

$$\rho = \frac{nA_{\text{Ir}}}{V_C N_A}$$

And solving for  $R$  from the above two expressions yields

$$R = \left( \frac{nA_{\text{Ir}}}{16\rho N_A \sqrt{2}} \right)^{1/3}$$

$$= \left[ \frac{(4 \text{ atoms/unit cell})(192.2 \text{ g/mol})}{(\sqrt{2})(16)(22.4 \text{ g/cm}^3)(6.023 \times 10^{23} \text{ atoms/mol})} \right]^{1/3}$$

$$= 1.36 \times 10^{-8} \text{ cm} = 0.136 \text{ nm}$$

- 3.10 This problem asks for us to calculate the radius of a vanadium atom. For BCC,  $n = 2$  atoms/unit cell, and

$$V_C = \left(\frac{4R}{\sqrt{3}}\right)^3 = \frac{64R^3}{3\sqrt{3}}$$

Since,

$$\rho = \frac{nA_V}{V_C N_A}$$

and solving for **R**

$$R = \left( \frac{3n\sqrt{3}A_V}{64\rho N_A} \right)^{1/3}$$

$$= \left[ \frac{(3\sqrt{3})(2 \text{ atoms/unit cell})(50.9 \text{ g/mol})}{(64)(5.96 \text{ g/cm}^3)(6.023 \times 10^{23} \text{ atoms/mol})} \right]^{1/3}$$

$$= 1.32 \times 10^{-8} \text{ cm} = 0.132 \text{ nm}$$

3.11 For the simple cubic crystal structure, the value of **n** in Equation (3.5) is unity since there is only a single atom associated with each unit cell. Furthermore, for the unit cell edge length, **a** = 2**R**. Therefore, employment of Equation (3.5) yields

$$\rho = \frac{nA}{V_C N_A} = \frac{nA}{(2R)^3 N_A}$$

$$= \frac{(1 \text{ atom/unit cell})(74.5 \text{ g/mol})}{\left\{ \left[ (2)(1.45 \times 10^{-8} \text{ cm}) \right]^3 / (\text{unit cell}) \right\} (6.023 \times 10^{23} \text{ atoms/mol})}$$

$$5.07 \text{ g/cm}^3$$

3.12. (a) The volume of the Ti unit cell may be computed using Equation (3.5) as

$$V_C = \frac{nA_{\text{Ti}}}{\rho N_A}$$

Now, for HCP, **n** = 6 atoms/unit cell, and for Ti, **A<sub>Ti</sub>** = 47.9 g/mol. Thus,

$$V_C = \frac{(6 \text{ atoms/unit cell})(47.9 \text{ g/mol})}{(4.51 \text{ g/cm}^3)(6.023 \times 10^{23} \text{ atoms/mol})}$$

$$= 1.058 \times 10^{-22} \text{ cm}^3/\text{unit cell} = 1.058 \times 10^{-28} \text{ m}^3/\text{unit cell}$$

(b) From the solution to Problem 3.7, since  $\mathbf{a} = 2\mathbf{R}$ , then, for HCP

$$V_C = \frac{3\sqrt{3} a^2 c}{2}$$

but, since  $\mathbf{c} = 1.58\mathbf{a}$

$$V_C = \frac{3\sqrt{3} (1.58)a^3}{2} = 1.058 \times 10^{-22} \text{ cm}^3/\text{unit cell}$$

Now, solving for  $\mathbf{a}$

$$a = \left[ \frac{(2)(1.058 \times 10^{-22} \text{ cm}^3)}{(3)(\sqrt{3})(1.58)} \right]^{1/3}$$

$$= 2.96 \times 10^{-8} \text{ cm} = 0.296 \text{ nm}$$

And finally

$$c = 1.58a = (1.58)(0.296 \text{ nm}) = 0.468 \text{ nm}$$

3.13 This problem asks that we calculate the theoretical densities of Al, Ni, Mg, and W.

Since Al has an FCC crystal structure,  $\mathbf{n} = 4$ , and  $V_C = (2R\sqrt{2})^3$ . Also,  $\mathbf{R} = 0.143 \text{ nm}$  ( $1.43 \times 10^{-8} \text{ cm}$ ) and  $\mathbf{A}_{\text{Al}} = 26.98 \text{ g/mol}$ . Employment of Equation (3.5) yields

$$\rho = \frac{(4 \text{ atoms/unit cell})(26.98 \text{ g/mol})}{\left\{ \left[ (2)(1.43 \times 10^{-8} \text{ cm})(\sqrt{2}) \right]^3 / (\text{unit cell}) \right\} (6.023 \times 10^{23} \text{ atoms/mol})}$$

$$= 2.71 \text{ g/cm}^3$$

The value given in the table inside the front cover is  $2.71 \text{ g/cm}^3$ .

Nickel also has an FCC crystal structure and therefore

$$\rho = \frac{(4 \text{ atoms/unit cell})(58.69 \text{ g/mol})}{\left\{ \left[ (2)(1.25 \times 10^{-8} \text{ cm})(\sqrt{2}) \right]^3 / (\text{unit cell}) \right\} (6.023 \times 10^{23} \text{ atoms/mol})}$$

$$= 8.82 \text{ g/cm}^3$$

The value given in the table is  $8.90 \text{ g/cm}^3$ .

Magnesium has an HCP crystal structure, and from Problem 3.7,

$$V_C = \frac{3\sqrt{3} a^2 c}{2}$$

and, since  $c = 1.624a$  and  $a = 2R = 2(1.60 \times 10^{-8} \text{ cm}) = 3.20 \times 10^{-8} \text{ cm}$

$$V_C = \frac{3\sqrt{3} (1.624) (3.20 \times 10^{-8} \text{ cm})^3}{2} = 1.38 \times 10^{-22} \text{ cm}^3/\text{unit cell}$$

Also, there are 6 atoms/unit cell for HCP. Therefore the theoretical density is

$$\rho = \frac{nA_{\text{Mg}}}{V_C N_A}$$

$$= \frac{(6 \text{ atoms/unit cell})(24.31 \text{ g/mol})}{(1.38 \times 10^{-22} \text{ cm}^3/\text{unit cell}) (6.023 \times 10^{23} \text{ atoms/mol})}$$

$$= 1.75 \text{ g/cm}^3$$

The value given in the table is  $1.74 \text{ g/cm}^3$ .

Tungsten has a BCC crystal structure for which  $n = 2$  and  $a = \frac{4R}{\sqrt{3}}$ ; also  $A_{\text{W}} = 183.85 \text{ g/mol}$

and  $R = 0.137 \text{ nm}$ . Therefore, employment of Equation (3.5) leads to

$$\rho = \frac{(2 \text{ atoms/unit cell})(183.85 \text{ g/mol})}{\left[ \frac{(4)(1.37 \times 10^{-8} \text{ cm})}{\sqrt{3}} \right]^3 / (\text{unit cell})} (6.023 \times 10^{23} \text{ atoms/mol})$$

$$= 19.3 \text{ g/cm}^3$$

The value given in the table is  $19.3 \text{ g/cm}^3$ .

3.14 In order to determine whether Nb has an FCC or BCC crystal structure, we need to compute its density for each of the crystal structures. For FCC,  $n = 4$ , and  $a = 2R\sqrt{2}$ . Also, from Figure 2.6, its atomic weight is  $92.91 \text{ g/mol}$ . Thus, for FCC

$$\rho = \frac{nA_{\text{Nb}}}{(2R\sqrt{2})^3 N_A}$$

$$= \frac{(4 \text{ atoms/unit cell})(92.91 \text{ g/mol})}{\left[ (2)(1.43 \times 10^{-8} \text{ cm})(\sqrt{2}) \right]^3 / (\text{unit cell})} (6.023 \times 10^{23} \text{ atoms/mol})$$

$$= 9.33 \text{ g/cm}^3$$

For BCC,  $n = 2$ , and  $a = \frac{4R}{\sqrt{3}}$ , thus

$$= \frac{(2 \text{ atoms/unit cell})(92.91 \text{ g/mol})}{\left[ \frac{(4)(1.43 \times 10^{-8} \text{ cm})}{\sqrt{3}} \right]^3 / (\text{unit cell})} (6.023 \times 10^{23} \text{ atoms/mol})$$

$$= 8.57 \text{ g/cm}^3$$

which is the value provided in the problem. Therefore, Nb has a BCC crystal structure.

3.15 For each of these three alloys we need to, by trial and error, calculate the density using Equation (3.5), and compare it to the value cited in the problem. For SC, BCC, and FCC crystal structures,

the respective values of  $n$  are 1, 2, and 4, whereas the expressions for  $a$  (since  $V_C = a^3$ ) are  $2R$ ,  $2R\sqrt{2}$ , and  $4R/\sqrt{3}$ .

For alloy A, let us calculate  $\rho$  assuming a BCC crystal structure.

$$\begin{aligned} \rho &= \frac{nA_A}{V_C N_A} \\ &= \frac{(2 \text{ atoms/unit cell})(43.1 \text{ g/mol})}{\left[ \frac{(4)(1.22 \times 10^{-8} \text{ cm})^3}{\sqrt{3}} \right] / (\text{unit cell})} (6.023 \times 10^{23} \text{ atoms/mol}) \\ &= 6.40 \text{ g/cm}^3 \end{aligned}$$

Therefore, its crystal structure is BCC.

For alloy B, let us calculate  $\rho$  assuming a simple cubic crystal structure.

$$\begin{aligned} \rho &= \frac{(1 \text{ atom/unit cell})(184.4 \text{ g/mol})}{\left[ (2)(1.46 \times 10^{-8} \text{ cm})^3 \right] / (\text{unit cell})} (6.023 \times 10^{23} \text{ atoms/mol}) \\ &= 12.3 \text{ g/cm}^3 \end{aligned}$$

Therefore, its crystal structure is simple cubic.

For alloy C, let us calculate  $\rho$  assuming a BCC crystal structure.

$$\begin{aligned} \rho &= \frac{(2 \text{ atoms/unit cell})(91.6 \text{ g/mol})}{\left[ \frac{(4)(1.37 \times 10^{-8} \text{ cm})^3}{\sqrt{3}} \right] / (\text{unit cell})} (6.023 \times 10^{23} \text{ atoms/mol}) \\ &= 9.60 \text{ g/cm}^3 \end{aligned}$$

Therefore, its crystal structure is BCC.

3.16 In order to determine the **APF** for U, we need to compute both the unit cell volume ( $V_C$ ) which is just the product of the three unit cell parameters, as well as the total sphere volume ( $V_S$ ) which is just the product of the volume of a single sphere and the number of spheres in the unit cell ( $n$ ). The value of  $n$  may be calculated from Equation (3.5) as

$$n = \frac{\rho V_C N_A}{A_U}$$

$$= \frac{(19.05)(2.86)(5.87)(4.95) \left( \times 10^{-24} \right) \left( 6.023 \times 10^{23} \right)}{283.03}$$

$$= 4.01 \text{ atoms/unit cell}$$

Therefore

$$\text{APF} = \frac{V_S}{V_C} = \frac{(4) \left( \frac{4}{3} \pi R^3 \right)}{(a)(b)(c)}$$

$$= \frac{(4) \left[ \frac{4}{3} (\pi)(0.1385)^3 \right]}{(0.286)(0.587)(0.495)}$$

$$= 0.536$$

3.17 (a) From the definition of the **APF**

$$\text{APF} = \frac{V_S}{V_C} = \frac{n \left( \frac{4}{3} \pi R^3 \right)}{a^2 c}$$

we may solve for the number of atoms per unit cell,  $n$ , as

$$n = \frac{(\text{APF}) a^2 c}{\frac{4}{3} \pi R^3}$$



$$= \frac{(0.693)(4.59)^2(4.95) (10^{-24} \text{ cm}^3)}{\frac{4}{3}\pi (1.625 \times 10^{-8} \text{ cm})^3}$$

$$= 4.0 \text{ atoms/unit cell}$$

(b) In order to compute the density, we just employ Equation (3.5) as

$$\rho = \frac{nA_{\text{In}}}{a^2cN_A}$$

$$= \frac{(4 \text{ atoms/unit cell})(114.82 \text{ g/mol})}{\left[ (4.59 \times 10^{-8} \text{ cm})^2 (4.95 \times 10^{-8} \text{ cm}) \text{ unit cell} \right] (6.023 \times 10^{23} \text{ atoms/mol})}$$

$$= 7.31 \text{ g/cm}^3$$

3. 18 (a) We are asked to calculate the unit cell volume for Be. From the solution to Problem 3.7

$$V_C = 6R^2c\sqrt{3}$$

But,  $c = 1.568a$ , and  $a = 2R$ , or  $c = 3.14R$ , and

$$V_C = (6)(3.14) R^3 \sqrt{3}$$

$$= (6)(3.14)(\sqrt{3}) \left[ 0.1143 \times 10^{-7} \text{ cm} \right]^3 = 4.87 \times 10^{-23} \text{ cm}^3/\text{unit cell}$$

(b) The density of Be is determined as follows:

$$\rho = \frac{nA_{\text{Be}}}{V_C N_A}$$

For HCP,  $n = 6$  atoms/unit cell, and for Be,  $A_{\text{Be}} = 9.01$  g/mol. Thus,

$$\rho = \frac{(6 \text{ atoms/unit cell})(9.01 \text{ g/mol})}{(4.87 \times 10^{-23} \text{ cm}^3/\text{unit cell}) (6.023 \times 10^{23} \text{ atoms/mol})}$$

$$= 1.84 \text{ g/cm}^3$$

The value given in the literature is  $1.85 \text{ g/cm}^3$ .

3.19 This problem calls for us to compute the atomic radius for Mg. In order to do this we must use Equation (3.5), as well as the expression which relates the atomic radius to the unit cell volume for HCP; from Problem 3.7 it was shown that

$$V_C = 6R^2c\sqrt{3}$$

In this case  $c = 1.624(2R)$ . Making this substitution into the previous equation, and then solving for  $R$  using Equation (3.5) yields

$$R = \left[ \frac{n_{A_{\text{Mg}}}}{(1.624)(12\sqrt{3})\rho N_A} \right]^{1/3}$$

$$= \left[ \frac{(6 \text{ atoms/unit cell})(24.31 \text{ g/mol})}{(1.624)(12\sqrt{3})(1.74 \text{ g/cm}^3)(6.023 \times 10^{23} \text{ atoms/mol})} \right]^{1/3}$$

$$= 1.60 \times 10^{-8} \text{ cm} = 0.160 \text{ nm}$$

3.20 This problem asks that we calculate the unit cell volume for Co which has an HCP crystal structure. In order to do this, it is necessary to use a result of Problem 3.7, that is

$$V_C = 6R^2c\sqrt{3}$$

The problem states that  $c = 1.623a$ , and  $a = 2R$ . Therefore

$$V_C = (1.623)(12\sqrt{3})R^3$$

$$= (1.623)(12\sqrt{3})(1.253 \times 10^{-8} \text{ cm})^3 = 6.64 \times 10^{-23} \text{ cm}^3 = 6.64 \times 10^{-2} \text{ nm}^3$$

- 3.21 (a) The unit cell shown in the problem belongs to the tetragonal crystal system since  $\mathbf{a} = \mathbf{b} = 0.35$  nm,  $\mathbf{c} = 0.45$  nm, and  $\alpha = \beta = \gamma = 90^\circ$ .
- (b) The crystal structure would be called body-centered tetragonal.
- (c) As with BCC,  $\mathbf{n} = 2$  atoms/unit cell. Also, for this unit cell

$$V_C = (3.5 \times 10^{-8} \text{ cm})^2 (4.5 \times 10^{-8} \text{ cm})$$

$$= 5.51 \times 10^{-23} \text{ cm}^3/\text{unit cell}$$

Thus,

$$\rho = \frac{nA}{V_C N_A}$$

$$= \frac{(2 \text{ atoms/unit cell})(141 \text{ g/mol})}{(5.51 \times 10^{-23} \text{ cm}^3/\text{unit cell})(6.023 \times 10^{23} \text{ atoms/mol})}$$

$$= 8.50 \text{ g/cm}^3$$

- 3.22 First of all, open 'Notepad' in Windows. Now enter into "Notepad" commands to generate the AuCu<sub>3</sub> unit cell. One set of commands that may be used is as follows:

```
[DisplayProps]
Rotatez=-30
Rotatey=-15

[AtomProps]
Gold=LtRed,0.14
Copper=LtYellow,0.13

[BondProps]
SingleSolid=LtGray

[Atoms]
Au1=1,0,0,Gold
Au2=0,0,0,Gold
Au3=0,1,0,Gold
Au4=1,1,0,Gold
Au5=1,0,1,Gold
Au6=0,0,1,Gold
```

```
Au7=0,1,1,Gold
Au8=1,1,1,Gold
Cu1=0.5,0,0.5,Copper
Cu2=0,0.5,0.5,Copper
Cu3=0.5,1,0.5,Copper
Cu4=1,0.5,0.5,Copper
Cu5=0.5,0.5,1,Copper
Cu6=0.5,0.5,0,Copper
```

```
[Bonds]
B1=Au1,Au5,SingleSolid
B2=Au5,Au6,SingleSolid
B3=Au6,Au2,SingleSolid
B4=Au2,Au1,SingleSolid
B5=Au4,Au8,SingleSolid
B6=Au8,Au7,SingleSolid
B7=Au7,Au3,SingleSolid
B8=Au3,Au4,SingleSolid
B9=Au1,Au4,SingleSolid
B10=Au8,Au5,SingleSolid
B11=Au2,Au3,SingleSolid
B12=Au6,Au7,SingleSolid
```

Under the "File" menu of "Note Pad," click "Save As", and then assign the file for this figure a name followed by a period and "mdf"; for example, "AuCu3.mdf". And, finally save this file in the "mdf" folder inside of the "Interactive MSE" folder (which may be found in its installed location).

Now, in order to view the unit cell just generated, bring up "Interactive MSE", and then open any one of the three submodules under "Crystallinity and Unit Cells" or the "Ceramic Structures" module. Next select "Open" under the "File" menu, and then open the "mdf" folder. Finally, select the name you assigned to the item in the window that appears, and hit the "OK" button. The image that you generated will now be displayed.

3.23 First of all, open "Notepad" in Windows.. Now enter into "Notepad" commands to generate the AuCu unit cell. One set of commands that may be used is as follows:

```
[DisplayProps]
Rotatez=-30
Rotatex=-15

[AtomProps]
Gold=LtRed,0.14
Copper=LtYellow,0.13

[BondProps]
SingleSolid=LtGray

[Atoms]
Au1=0,0,0,Gold
Au2=1,0,0,Gold
Au3=1,1,0,Gold
Au4=0,1,0,Gold
Au5=0,0,1.27,Gold
Au6=1,0,1.27,Gold
```

Au7=1,1,1.27,Gold  
 Au8=0,1,1.27,Gold  
 Cu1=0.5,0.5,0.635,Copper

[Bonds]  
 B1=Au1,Au2,SingleSolid  
 B2=Au2,Au3,SingleSolid  
 B3=Au3,Au4,SingleSolid  
 B4=Au1,Au4,SingleSolid  
 B5=Au5,Au6,SingleSolid  
 B6=Au6,Au7,SingleSolid  
 B7=Au7,Au8,SingleSolid  
 B8=Au5,Au8,SingleSolid  
 B9=Au1,Au5,SingleSolid  
 B10=Au2,Au6,SingleSolid  
 B11=Au3,Au7,SingleSolid  
 B12=Au4,Au8,SingleSolid

Under the "File" menu of "Note Pad," click "Save As", and then assign the file for this figure a name followed by a period and "mdf"; for example, "AuCu.mdf". And, finally save this file in the "mdf" folder inside of the "Interactive MSE" folder (which may be found in its installed location).

Now, in order to view the unit cell just generated, bring up "Interactive MSE", and then open any one of the three submodules under "Crystallinity and Unit Cells" or the "Ceramic Structures" module. Next select "Open" under the "File" menu, and then open the "mdf" folder. Finally, select the name you assigned to the item in the window that appears, and hit the "OK" button. The image that you generated will now be displayed.

3.24 A unit cell for the face-centered orthorhombic crystal structure is presented below.

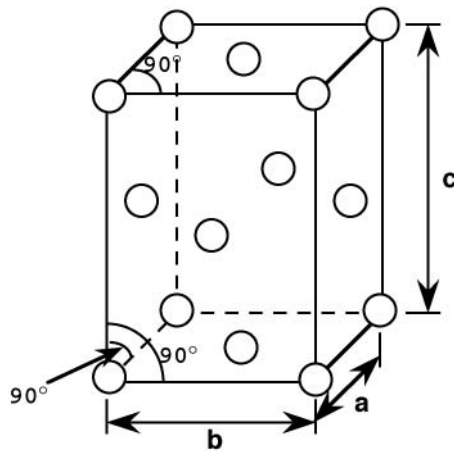

3.25 This problem asks that we list the point coordinates for all of the atoms that are associated with the FCC unit cell. From Figure 3.1b, the atom located at the origin of the unit cell has the coordinates

000. Coordinates for other atoms in the bottom face are 100, 110, 010, and  $\frac{1}{2}\frac{1}{2}0$ . (The  $z$  coordinate for all these points is zero.)

For the top unit cell face, the coordinates are 001, 101, 111, 011, and  $\frac{1}{2}\frac{1}{2}1$ . (These coordinates are the same as bottom-face coordinates except that the “0”  $z$  coordinate has been replaced by a “1”.)

Coordinates for only those atoms that are positioned at the centers of both side faces, and centers of both front and back faces need to be specified. For the front and back-center face atoms, the coordinates are  $1\frac{1}{2}\frac{1}{2}$  and  $0\frac{1}{2}\frac{1}{2}$ , respectively. While for the left and right side center-face atoms, the respective coordinates are  $\frac{1}{2}0\frac{1}{2}$  and  $\frac{1}{2}1\frac{1}{2}$ .

3.26 (a) Here we are asked list point coordinates for both sodium and chlorine ions for a unit cell of the sodium chloride crystal structure, which is shown in Figure 12.2.

In Figure 12.2, the chlorine ions are situated at all corners and face-centered positions. Therefore, point coordinates for these ions are the same as for FCC, as presented in the previous problem—that is, 000, 100, 110, 010, 001, 101, 111, 011,  $\frac{1}{2}\frac{1}{2}0$ ,  $\frac{1}{2}\frac{1}{2}1$ ,  $1\frac{1}{2}\frac{1}{2}$ ,  $0\frac{1}{2}\frac{1}{2}$ ,  $\frac{1}{2}0\frac{1}{2}$ , and  $\frac{1}{2}1\frac{1}{2}$ .

Furthermore, the sodium ions are situated at the centers of all unit cell edges, and, in addition, at the unit cell center. For the bottom face of the unit cell, the point coordinates are as follows:  $\frac{1}{2}00$ ,  $1\frac{1}{2}0$ ,  $\frac{1}{2}10$ ,  $0\frac{1}{2}0$ . While, for the horizontal plane that passes through the center of the unit cell (which includes the ion at the unit cell center), the coordinates are  $00\frac{1}{2}$ ,  $10\frac{1}{2}$ ,  $\frac{1}{2}\frac{1}{2}\frac{1}{2}$ ,  $11\frac{1}{2}$ , and  $01\frac{1}{2}$ . And for the four ions on the top face  $\frac{1}{2}01$ ,  $1\frac{1}{2}1$ ,  $\frac{1}{2}11$ , and  $0\frac{1}{2}1$ .

(b) This portion of the problem calls for us to list the point coordinates of both the zinc and sulfur atoms for a unit cell of the zinc blende structure, which is shown in Figure 12.4.

First of all, the sulfur atoms occupy the face-centered positions in the unit cell, which from the solution to Problem 3.25, are as follows: 000, 100, 110, 010, 001, 101, 111, 011,  $\frac{1}{2}\frac{1}{2}0$ ,  $\frac{1}{2}\frac{1}{2}1$ ,  $1\frac{1}{2}\frac{1}{2}$ ,  $0\frac{1}{2}\frac{1}{2}$ ,  $\frac{1}{2}0\frac{1}{2}$ , and  $\frac{1}{2}1\frac{1}{2}$ .

Now, using an  $x$ - $y$ - $z$  coordinate system oriented as in Figure 3.4, the coordinates of the zinc atom that lies toward the lower-left-front of the unit cell has the coordinates  $\frac{3}{4}\frac{1}{4}\frac{1}{4}$ , whereas the atom situated toward the lower-right-back of the unit cell has coordinates of  $\frac{1}{4}\frac{3}{4}\frac{1}{4}$ . Also, the zinc atom that resides toward the upper-left-back of the unit cell has the  $\frac{1}{4}\frac{1}{4}\frac{3}{4}$  coordinates. And, the coordinates of the final zinc atom, located toward the upper-right-front of the unit cell, are  $\frac{3}{4}\frac{3}{4}\frac{3}{4}$ .

3.27 A tetragonal unit in which are shown the  $11\frac{1}{2}$  and  $\frac{1}{2}\frac{1}{4}\frac{1}{2}$  point coordinates is presented below.

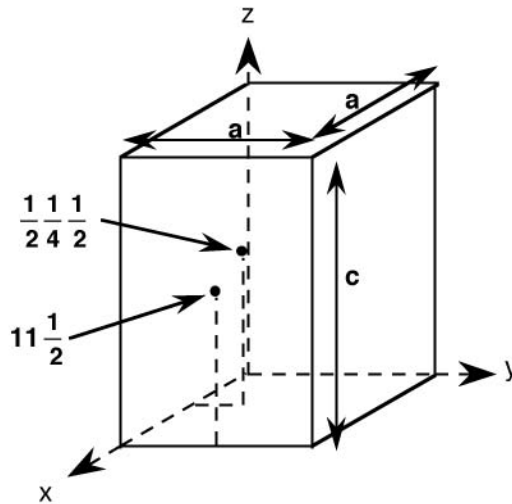

3.28 This portion of the problem calls for us to draw a  $[12\bar{1}]$  direction within an orthorhombic unit cell ( $a \neq b \neq c$ ,  $\alpha = \beta = \gamma = 90^\circ$ ). Such a unit cell with its origin positioned at point **O** is shown below. We first move along the **+x**-axis **a** units (from point **O** to point **A**), then parallel to the **+y**-axis **2b** units (from point **A** to point **B**). Finally, we proceed parallel to the **z**-axis **-c** units (from point **B** to point **C**). The  $[12\bar{1}]$  direction is the vector from the origin (point **O**) to point **C** as shown.

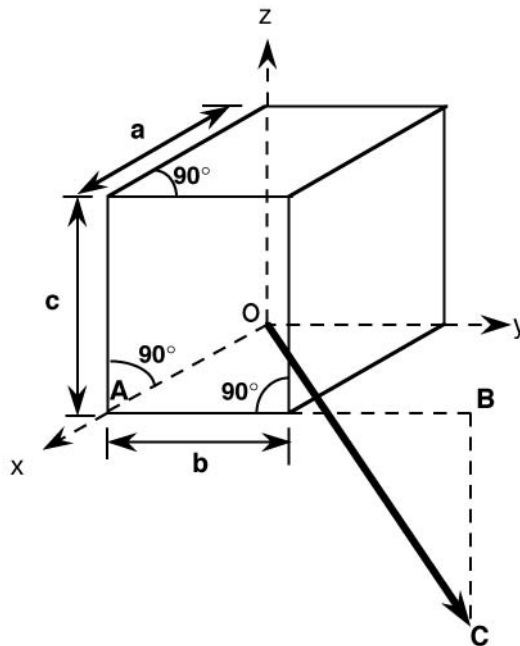

We are now asked to draw a (210) plane within an orthorhombic unit cell. First remove the three indices from the parentheses, and take their reciprocals--i.e., 1/2, 1, and  $\infty$ . This means that the

plane intercepts the  $x$ -axis at  $a/2$ , the  $y$ -axis at  $b$ , and parallels the  $z$ -axis. The plane that satisfies these requirements has been drawn within the orthorhombic unit cell below.

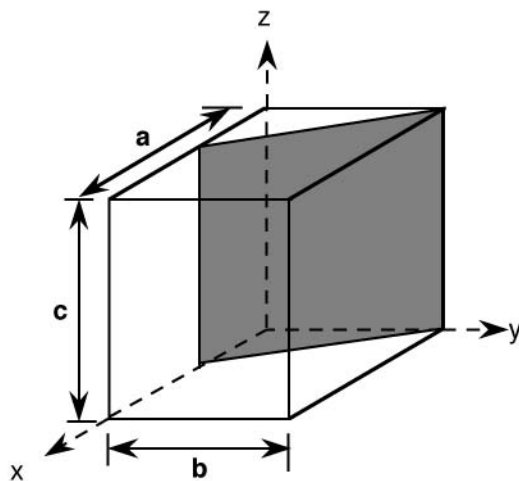

3.29 (a) This portion of the problem asks that a  $[0\bar{1}1]$  direction be drawn within a monoclinic unit cell ( $a \neq b \neq c$ , and  $\alpha = \beta = 90^\circ \neq \gamma$ ). One such unit cell with its origin at point  $O$  is sketched below. For this direction, there is no projection along the  $x$ -axis since the first index is zero; thus, the direction lies in the  $y$ - $z$  plane. We next move from the origin along the minus  $y$ -axis  $b$  units (from point  $O$  to point  $R$ ). Since the final index is a one, move from point  $R$  parallel to the  $z$ -axis,  $c$  units (to point  $P$ ). Thus, the  $[0\bar{1}1]$  direction corresponds to the vector passing from the origin to point  $P$ , as indicated in the figure.

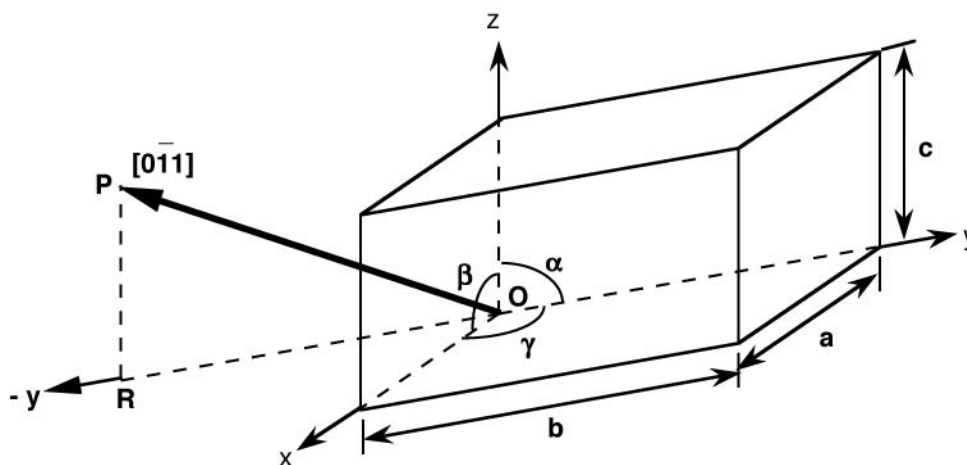



(b) A (002) plane is drawn within the monoclinic cell shown below. We first remove the parentheses and take the reciprocals of the indices; this gives  $\infty$ ,  $\infty$ , and  $1/2$ . Thus, the (002) plane parallels both **x**- and **y**-axes, and intercepts the **z**-axis at **c/2**, as indicated in the drawing.

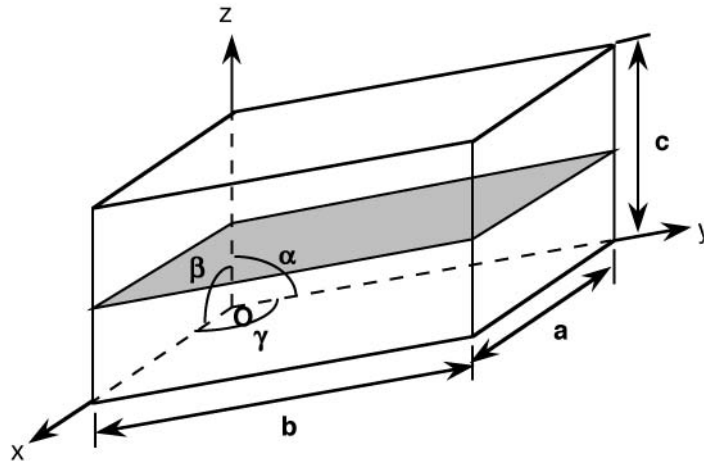

3.30 (a) We are asked for the indices of the two directions sketched in the figure. For direction **1**, the projection on the **x**-axis is zero (since it lies in the **y-z** plane), while projections on the **y**- and **z**-axes are **b/2** and **c**, respectively. This is an [012] direction as indicated in the summary below

	$\underline{x}$	$\underline{y}$	$\underline{z}$
Projections	0a	b/2	c
Projections in terms of <b>a</b> , <b>b</b> , and <b>c</b>	0	1/2	1
Reduction to integers	0	1	2
Enclosure		[012]	

Direction **2** is  $[1\bar{1}2]$  as summarized below.

	$\underline{x}$	$\underline{y}$	$\underline{z}$
Projections	a/2	b/2	-c
Projections in terms of <b>a</b> , <b>b</b> , and <b>c</b>	1/2	1/2	-1
Reduction to integers	1	1	-2

Enclosure

$[11\bar{2}]$

(b) This part of the problem calls for the indices of the two planes which are drawn in the sketch. Plane 1 is an (020) plane. The determination of its indices is summarized below.

	$\underline{x}$	$\underline{y}$	$\underline{z}$
Intercepts	$\infty a$	$b/2$	$\infty c$
Intercepts in terms of <b>a</b> , <b>b</b> , and <b>c</b>	$\infty$	$1/2$	$\infty$
Reciprocals of intercepts	0	2	0
Enclosure		(020)	

Plane 2 is a  $(2\bar{2}1)$  plane, as summarized below.

	$\underline{x}$	$\underline{y}$	$\underline{z}$
Intercepts	$a/2$	$-b/2$	$c$
Intercepts in terms of <b>a</b> , <b>b</b> , and <b>c</b>	$1/2$	$-1/2$	1
Reciprocals of intercepts	2	-2	1
Enclosure		$(2\bar{2}1)$	

3.31 The directions asked for are indicated in the cubic unit cells shown below.

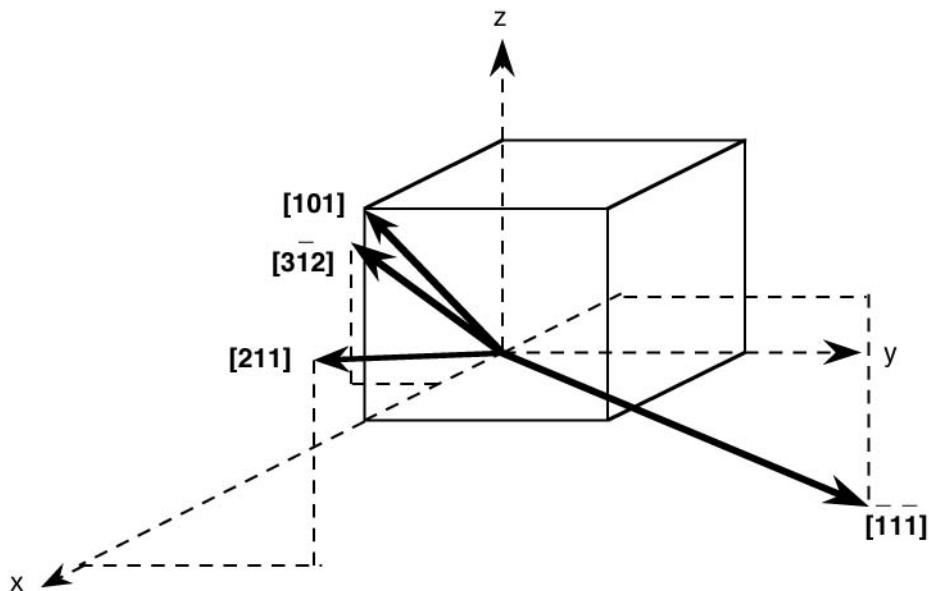

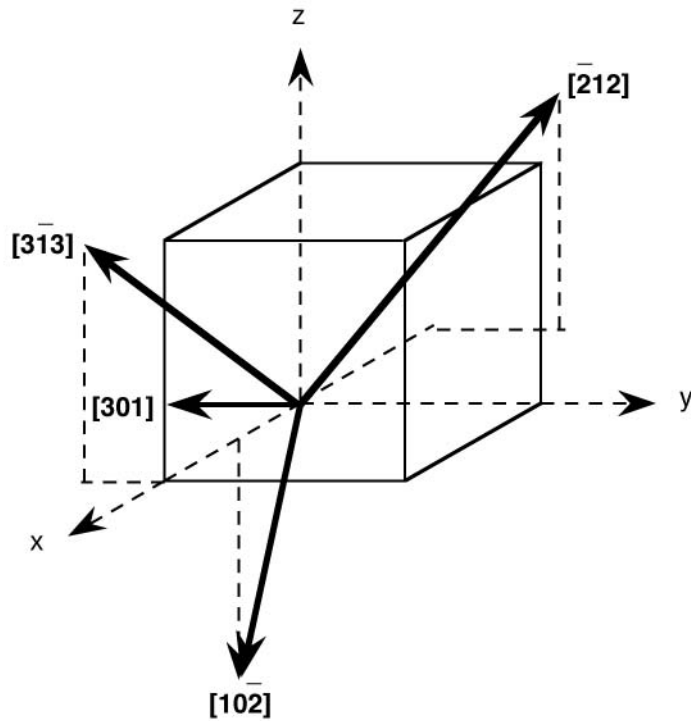

3.32 Direction **A** is a  $[\bar{1}10]$  direction, which determination is summarized as follows. We first of all position the origin of the coordinate system at the tail of the direction vector; then in terms of this new coordinate system

	$\bar{x}$	$\bar{y}$	$\bar{z}$
Projections	- a	b	0c
Projections in terms of <b>a, b,</b> and <b>c</b>	-1	1	0
Reduction to integers	not necessary		
Enclosure	$[\bar{1}10]$		

Direction **B** is a  $[121]$  direction, which determination is summarized as follows. The vector passes through the origin of the coordinate system and thus no translation is necessary. Therefore,

	$\bar{x}$	$\bar{y}$	$\bar{z}$
Projections	$\frac{a}{2}$	b	$\frac{c}{2}$
Projections in terms of <b>a, b,</b>			

and <b>c</b>	$\frac{1}{2}$	1	$\frac{1}{2}$
Reduction to integers	1	2	1
Enclosure		[121]	

Direction **C** is a  $[0\bar{1}\bar{2}]$  direction, which determination is summarized as follows. We first of all position the origin of the coordinate system at the tail of the direction vector; then in terms of this new coordinate system

	$\underline{x}$	$\underline{y}$	$\underline{z}$
Projections	0a	$-\frac{b}{2}$	-c
Projections in terms of <b>a, b,</b> and <b>c</b>	0	$-\frac{1}{2}$	-1
Reduction to integers	0	-1	-2
Enclosure		$[0\bar{1}\bar{2}]$	

Direction **D** is a  $[1\bar{2}1]$  direction, which determination is summarized as follows. We first of all position the origin of the coordinate system at the tail of the direction vector; then in terms of this new coordinate system

	$\underline{x}$	$\underline{y}$	$\underline{z}$
Projections	$\frac{a}{2}$	-b	$\frac{c}{2}$
Projections in terms of <b>a, b,</b> and <b>c</b>	$\frac{1}{2}$	-1	$\frac{1}{2}$
Reduction to integers	1	-2	1
Enclosure		$[1\bar{2}1]$	

3.33 Direction **A** is a  $[3\bar{3}\bar{1}]$  direction, which determination is summarized as follows. We first of all position the origin of the coordinate system at the tail of the direction vector; then in terms of this new coordinate system

	$\underline{x}$	$\underline{y}$	$\underline{z}$
Projections	a	b	$-\frac{c}{3}$
Projections in terms of <b>a, b,</b>			

and <b>c</b>	1	1	$-\frac{1}{3}$
Reduction to integers	3	3	-1
Enclosure		$[3\bar{3}\bar{1}]$	

Direction **B** is a  $[\bar{4}0\bar{3}]$  direction, which determination is summarized as follows. We first of all position the origin of the coordinate system at the tail of the direction vector; then in terms of this new coordinate system

	$\underline{x}$	$\underline{y}$	$\underline{z}$
Projections	$-\frac{2a}{3}$	0b	$-\frac{c}{2}$
Projections in terms of <b>a, b,</b> and <b>c</b>	$-\frac{2}{3}$	0	$-\frac{1}{2}$
Reduction to integers	-4	0	-3
Enclosure		$[\bar{4}0\bar{3}]$	

Direction **C** is a  $[\bar{3}6\bar{1}]$  direction, which determination is summarized as follows. We first of all position the origin of the coordinate system at the tail of the direction vector; then in terms of this new coordinate system

	$\underline{x}$	$\underline{y}$	$\underline{z}$
Projections	$-\frac{a}{2}$	b	$\frac{c}{6}$
Projections in terms of <b>a, b,</b> and <b>c</b>	$-\frac{1}{2}$	1	$\frac{1}{6}$
Reduction to integers	-3	6	1
Enclosure		$[\bar{3}6\bar{1}]$	

Direction **D** is a  $[\bar{1}\bar{1}\bar{1}]$  direction, which determination is summarized as follows. We first of all position the origin of the coordinate system at the tail of the direction vector; then in terms of this new coordinate system

	$\underline{x}$	$\underline{y}$	$\underline{z}$
Projections	$-\frac{a}{2}$	$\frac{b}{2}$	$-\frac{c}{2}$
Projections in terms of <b>a, b,</b>			

and <b>c</b>	$-\frac{1}{2}$	$\frac{1}{2}$	$-\frac{1}{2}$
Reduction to integers	- 1	1	- 1
Enclosure		$[\bar{1}1\bar{1}]$	

3.34 For tetragonal crystals  $\mathbf{a} = \mathbf{b} \neq \mathbf{c}$  and  $\alpha = \beta = \gamma = 90^\circ$ ; therefore, projections along the **x** and **y** axes are equivalent, which are not equivalent to projections along the **z** axis.

(a) Therefore, for the [011] direction, equivalent directions are the following: [101],  $[\bar{1}0\bar{1}]$ ,  $[\bar{1}01]$ ,  $[10\bar{1}]$ ,  $[01\bar{1}]$ ,  $[0\bar{1}1]$ , and  $[0\bar{1}\bar{1}]$ .

(b) Also, for the [100] direction, equivalent directions are the following:  $[\bar{1}00]$ , [010], and  $[0\bar{1}0]$ .

3.35 (a) We are asked to convert [100] and [111] directions into the four- index Miller-Bravais scheme for hexagonal unit cells. For [100]

$$u' = 1,$$

$$v' = 0,$$

$$w' = 0$$

From Equations (3.6)

$$u = \frac{n}{3}(2u' - v') = \frac{n}{3}(2 - 0) = \frac{2n}{3}$$

$$v = \frac{n}{3}(2v' - u') = \frac{n}{3}(0 - 1) = -\frac{n}{3}$$

$$t = -(u + v) = -\left(\frac{2n}{3} - \frac{n}{3}\right) = -\frac{n}{3}$$

$$w = nw' = 0$$

If we let  $n = 3$ , then  $u = 2$ ,  $v = -1$ ,  $t = -1$ , and  $w = 0$ . Thus, the direction is represented as  $[\mathbf{uvtw}] = [2\bar{1}\bar{1}0]$ .

For [111],  $u' = 1$ ,  $v' = 1$ , and  $w' = 1$ ; therefore,

$$u = \frac{n}{3}(2 - 1) = \frac{n}{3}$$

$$v = \frac{n}{3}(2 - 1) = \frac{n}{3}$$

$$t = -\left(\frac{n}{3} + \frac{n}{3}\right) = -\frac{2n}{3}$$

$$w = n$$

If we again let  $n = 3$ , then  $u = 1$ ,  $v = 1$ ,  $t = -2$ , and  $w = 3$ . Thus, the direction is represented as  $[11\bar{2}3]$ .

(b) This portion of the problem asks for the same conversion of the (010) and (101) planes. A plane for hexagonal is represented by  $(hkil)$  where  $i = - (h + k)$ , and  $h$ ,  $k$ , and  $l$  are the same for both systems. For the (010) plane,  $h = 0$ ,  $k = 1$ ,  $l = 0$ , and

$$i = - (0 + 1) = -1$$

Thus, the plane is now represented as  $(hkil) = (01\bar{1}0)$ .

For the (101) plane,  $i = - (1 + 0) = -1$ , and  $(hkil) = (10\bar{1}1)$ .

3.36 For plane **A** we will leave the origin at the unit cell as shown. If we extend this plane back into the plane of the page, then it is a  $(11\bar{1})$  plane, as summarized below.

	$x$	$y$	$z$
Intercepts	$a$	$b$	$-c$
Intercepts in terms of <b>a</b> , <b>b</b> , and <b>c</b>	1	1	-1
Reciprocals of intercepts	1	1	-1
Reduction	not necessary		
Enclosure	$(11\bar{1})$		

For plane **B** we will leave the origin of the unit cell as shown; this is a (230) plane, as summarized below.

	$x$	$y$	$z$
Intercepts	$\frac{a}{2}$	$\frac{b}{3}$	$\infty c$
Intercepts in terms of <b>a</b> , <b>b</b> ,			

and <b>c</b>	$\frac{1}{2}$	$\frac{1}{3}$	$\infty$
Reciprocals of intercepts	2	3	0
Enclosure		(230)	

3.37 For plane **A** we will move the origin of the coordinate system one unit cell distance to the right along the **y** axis; thus, this is a  $(1\bar{1}0)$  plane, as summarized below.

	<u>x</u>	<u>y</u>	<u>z</u>
Intercepts	$\frac{a}{2}$	$-\frac{b}{2}$	$\infty$ c
Intercepts in terms of <b>a, b,</b> and <b>c</b>	$\frac{1}{2}$	$-\frac{1}{2}$	$\infty$
Reciprocals of intercepts	2	-2	0
Reduction	1	-1	0
Enclosure		$(1\bar{1}0)$	

For plane **B** we will leave the origin of the unit cell as shown; thus, this is a (122) plane, as summarized below.

	<u>x</u>	<u>y</u>	<u>z</u>
Intercepts	a	$\frac{b}{2}$	$\frac{c}{2}$
Intercepts in terms of <b>a, b,</b> and <b>c</b>	1	$\frac{1}{2}$	$\frac{1}{2}$
Reciprocals of intercepts	1	2	2
Reduction		not necessary	
Enclosure		(122)	

3.38 For plane **A** since the plane passes through the origin of the coordinate system as shown, we will move the origin of the coordinate system one unit cell distance vertically along the **z** axis; thus, this is a  $(21\bar{1})$  plane, as summarized below.



	$\underline{x}$	$\underline{y}$	$\underline{z}$
Intercepts	$\frac{a}{2}$	$b$	$-c$
Intercepts in terms of <b>a, b,</b> and <b>c</b>	$\frac{1}{2}$	$1$	$-1$
Reciprocals of intercepts	$2$	$1$	$-1$
Reduction		not necessary	
Enclosure		$(2\bar{1}\bar{1})$	

For plane **B**, since the plane passes through the origin of the coordinate system as shown, we will move the origin one unit cell distance vertically along the **z** axis; this is a  $(02\bar{1})$  plane, as summarized below.

	$\underline{x}$	$\underline{y}$	$\underline{z}$
Intercepts	$\infty a$	$\frac{b}{2}$	$-c$
Intercepts in terms of <b>a, b,</b> and <b>c</b>	$\infty$	$\frac{1}{2}$	$-1$
Reciprocals of intercepts	$0$	$2$	$-1$
Reduction		not necessary	
Enclosure		$(02\bar{1})$	

3.39 The  $(01\bar{1}1)$  and  $(2\bar{1}\bar{1}0)$  planes in a hexagonal unit cell are shown below.

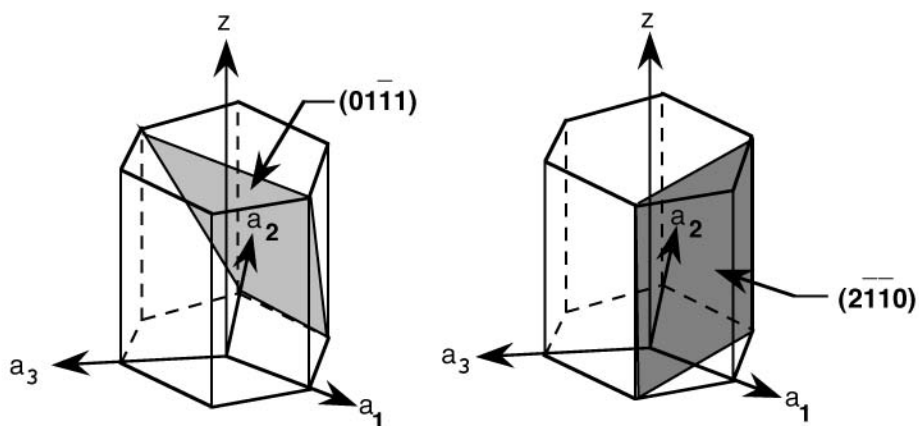

3.40 (a) For this plane we will leave the origin of the coordinate system as shown; thus, this is a  $(\bar{1}211)$  plane, as summarized below.

	$a_1$	$a_2$	$a_3$	$z$
Intercepts	$a$	$-\frac{a}{2}$	$a$	$c$
Intercepts in terms of $a$ 's and $c$	1	$-\frac{1}{2}$	1	1
Reciprocals of intercepts	1	-2	1	1
Reduction	not necessary			
Enclosure	$(\bar{1}211)$			

(b) For this plane we will leave the origin of the coordinate system as shown; thus, this is a  $(2\bar{1}\bar{1}2)$  plane, as summarized below.

	$a_1$	$a_2$	$a_3$	$z$
Intercepts	$a/2$	$-a$	$-a$	$c/2$
Intercepts in terms of $a$ 's and $c$	$1/2$	-1	-1	$1/2$
Reciprocals of intercepts	2	-1	-1	2
Reduction	not necessary			
Enclosure	$(2\bar{1}\bar{1}2)$			

3.41 The planes called for are plotted in the cubic unit cells shown below.

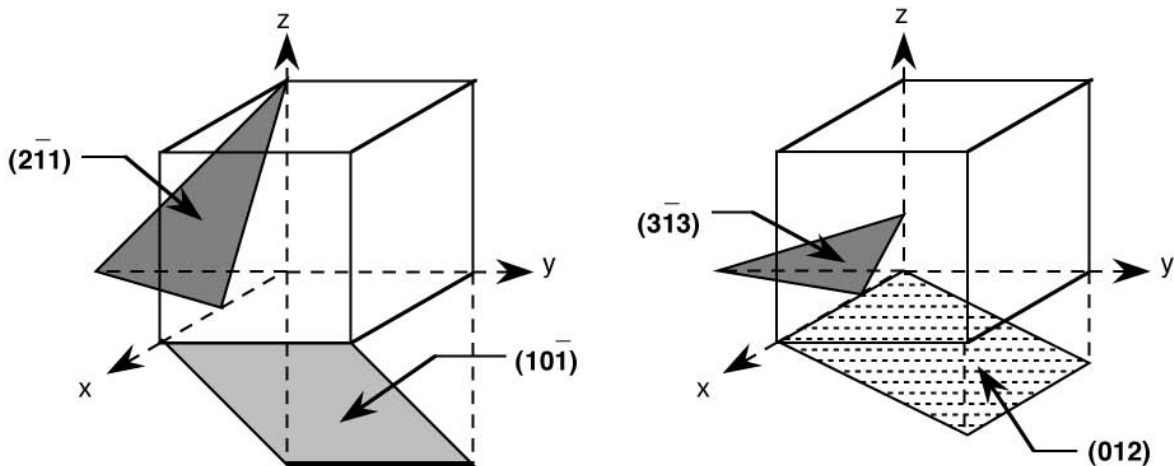

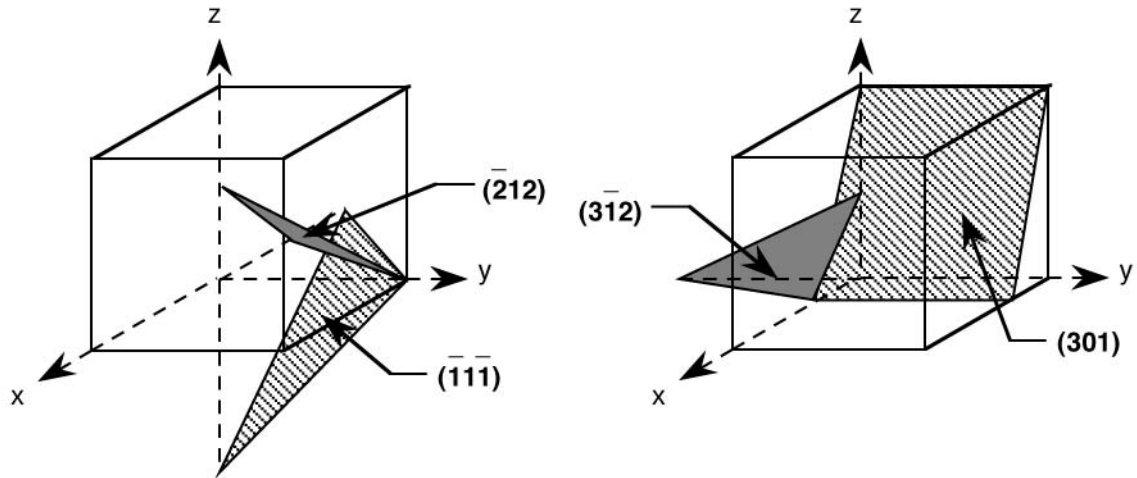

3.42 (a) The atomic packing of the (100) plane for the FCC crystal structure is called for. An FCC unit cell, its (100) plane, and the atomic packing of this plane are indicated below.

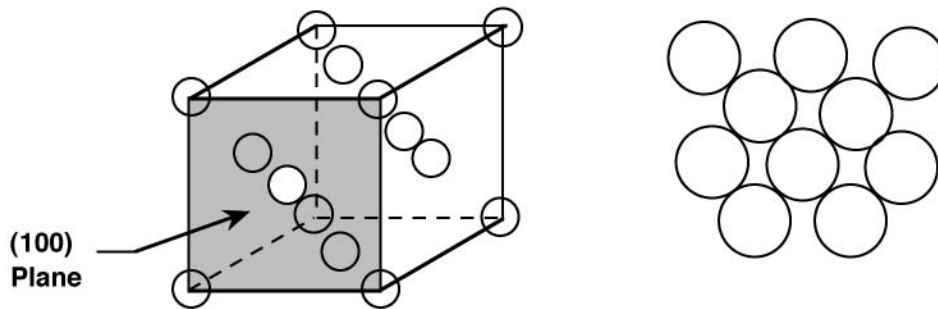

(b) For this part of the problem we are to show the atomic packing of the (111) plane for the BCC crystal structure. A BCC unit cell, its (111) plane, and the atomic packing of this plane are indicated below.

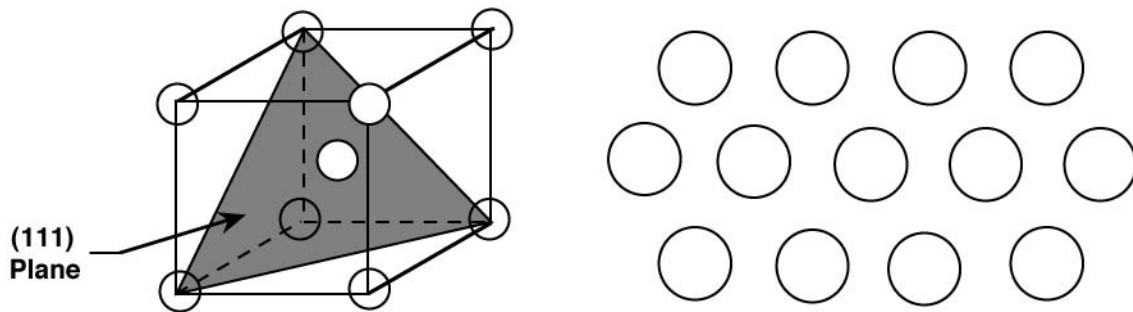

3.43 (a) The unit cell in Problem 3.21 is body-centered tetragonal. Only the (100) (front face) and (0 $\bar{1}$ 0) (left side face) planes are equivalent since the dimensions of these planes within the unit cell (and therefore the distances between adjacent atoms) are the same (namely 0.45 nm x 0.35 nm), which are different than the (001) (top face) plane (namely 0.35 nm x 0.35 nm).

(b) The equivalent planes are (101), (011), and ( $\bar{1}$ 01); the dimensions of these planes within the unit cell are the same--that is  $0.35 \text{ nm} \times \left[ (0.35 \text{ nm})^2 + (0.45 \text{ nm})^2 \right]^{1/2}$ .

(c) All of the (111), (1 $\bar{1}$ 1), (11 $\bar{1}$ ), and ( $\bar{1}$ 1 $\bar{1}$ ) planes are equivalent.

3.44 (a) The intersection between (110) and (111) planes results in a [ $\bar{1}$ 10], or equivalently, a [1 $\bar{1}$ 0] direction.

(b) The intersection between (110) and (1 $\bar{1}$ 0) planes results in a [001], or equivalently, a [00 $\bar{1}$ ] direction.

(c) The intersection between (11 $\bar{1}$ ) and (001) planes results in a [ $\bar{1}$ 10], or equivalently, a [1 $\bar{1}$ 0] direction.

3.45 (a) In the figure below is shown a [100] direction within an FCC unit cell.

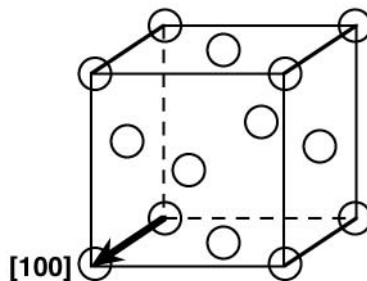

For this [100] direction there is one atom at each of the two unit cell corners, and, thus, there is the equivalent of 1 atom that is centered on the direction vector. The length of this direction vector is just the unit cell edge length,  $2R\sqrt{2}$  [Equation (3.1)]. Therefore, the expression for the linear density of this plane is

$$LD_{100} = \frac{\text{number of atoms centered on [100] direction vector}}{\text{length of [100] direction vector}}$$

$$= \frac{1 \text{ atom}}{2R\sqrt{2}} = \frac{1}{2R\sqrt{2}}$$

An FCC unit cell within which is drawn a [111] direction is shown below.

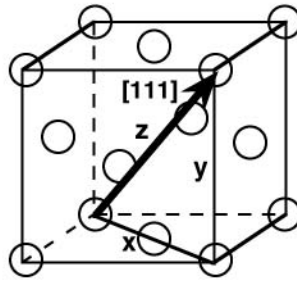

For this [111] direction, the vector shown passes through only the centers of the single atom at each of its ends, and, thus, there is the equivalence of 1 atom that is centered on the direction vector. The length of this direction vector is denoted by  $z$  in this figure, which is equal to

$$z = \sqrt{x^2 + y^2}$$

where  $x$  is the length of the bottom face diagonal, which is equal to  $4R$ . Furthermore,  $y$  is the unit cell edge length, which is equal to  $2R\sqrt{2}$  [Equation (3.1)]. Thus, using the above equation, the length  $z$  may be calculate as follows:

$$z = \sqrt{(4R)^2 + (2R\sqrt{2})^2} = \sqrt{24R^2} = 2R\sqrt{6}$$

Therefore, the expression for the linear density of this plane is

$$\begin{aligned} LD_{111} &= \frac{\text{number of atoms centered on [111] direction vector}}{\text{length of [111] direction vector}} \\ &= \frac{1 \text{ atom}}{2R\sqrt{6}} = \frac{1}{2R\sqrt{6}} \end{aligned}$$

(b) From the table inside the front cover, the atomic radius for copper is 0.128 nm. Therefore, the linear density for the [100] direction is

$$LD_{100}(\text{Cu}) = \frac{1}{2R\sqrt{2}} = \frac{1}{(2)(0.128 \text{ nm})\sqrt{2}} = 2.76 \text{ nm}^{-1} = 2.76 \times 10^{-9} \text{ m}^{-1}$$

While for the [111] direction

$$LD_{111}(\text{Cu}) = \frac{1}{2R\sqrt{6}} = \frac{1}{(2)(0.128 \text{ nm})\sqrt{6}} = 1.59 \text{ nm}^{-1} = 1.59 \times 10^{-9} \text{ m}^{-1}$$

3.46 (a) In the figure below is shown a [110] direction within a BCC unit cell.

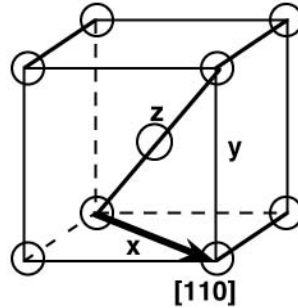

For this [110] direction there is one atom at each of the two unit cell corners, and, thus, there is the equivalence of 1 atom that is centered on the direction vector. The length of this direction vector is denoted by  $x$  in this figure, which is equal to

$$x = \sqrt{z^2 - y^2}$$

where  $y$  is the unit cell edge length, which, from Equation (3.3) is equal to  $\frac{4R}{\sqrt{3}}$ . Furthermore,  $z$  is the length of the unit cell diagonal, which is equal to  $4R$ . Thus, using the above equation, the length  $x$  may be calculate as follows:

$$x = \sqrt{(4R)^2 - \left(\frac{4R}{\sqrt{3}}\right)^2} = \sqrt{\frac{32R^2}{3}} = 4R\sqrt{\frac{2}{3}}$$

Therefore, the expression for the linear density of this direction is

$$\begin{aligned} LD_{110} &= \frac{\text{number of atoms centered on [110] direction vector}}{\text{length of [110] direction vector}} \\ &= \frac{1 \text{ atom}}{4R\sqrt{\frac{2}{3}}} = \frac{\sqrt{3}}{4R\sqrt{2}} \end{aligned}$$

A BCC unit cell within which is drawn a [111] direction is shown below.

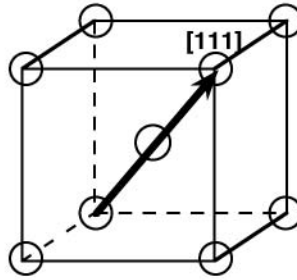

For although the [111] direction vector shown passes through the centers of three atoms, there is an equivalence of only two atoms associated with this unit cell—one-half of each of the two atoms at the end of the vector, in addition to the center atom belongs entirely to the unit cell. Furthermore, the length of the vector shown is equal to  $4R$ , since all of the atoms whose centers the vector passes through touch one another. Therefore, the linear density is equal to

$$LD_{111} = \frac{\text{number of atoms centered on [111] direction vector}}{\text{length of [111] direction vector}}$$

$$= \frac{2 \text{ atoms}}{4R} = \frac{1}{2R}$$

(b) From the table inside the front cover, the atomic radius for iron is 0.124 nm. Therefore, the linear density for the [110] direction is

$$LD_{110}(\text{Fe}) = \frac{\sqrt{3}}{4R\sqrt{2}} = \frac{\sqrt{3}}{(4)(0.124 \text{ nm})\sqrt{2}} = 2.47 \text{ nm}^{-1} = 2.47 \times 10^{-9} \text{ m}^{-1}$$

While for the [111] direction

$$LD_{111}(\text{Fe}) = \frac{1}{2R} = \frac{1}{(2)(0.124 \text{ nm})} = 4.03 \text{ nm}^{-1} = 4.03 \times 10^{-9} \text{ m}^{-1}$$

3.47 (a) In the figure below is shown a (100) plane for an FCC unit cell.

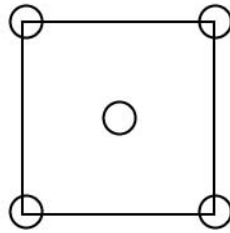

For this (100) plane there is one atom at each of the four cube corners, each of which is shared with four adjacent unit cells, while the center atom lies entirely within the unit cell. Thus, there is the equivalence of 2 atoms associated with this FCC (100) plane. The planar section represented in the above figure is a square, wherein the side lengths are equal to the unit cell edge length,  $2R\sqrt{2}$  [Equation (3.1)]; and, thus, the area of this square is just  $(2R\sqrt{2})^2 = 8R^2$ . Hence, the planar density for this (100) plane is just

$$\begin{aligned} PD_{100} &= \frac{\text{number of atoms centered on (100) plane}}{\text{area of (100) plane}} \\ &= \frac{2 \text{ atoms}}{8R^2} = \frac{1}{4R^2} \end{aligned}$$

That portion of an FCC (111) plane contained within a unit cell is shown below.

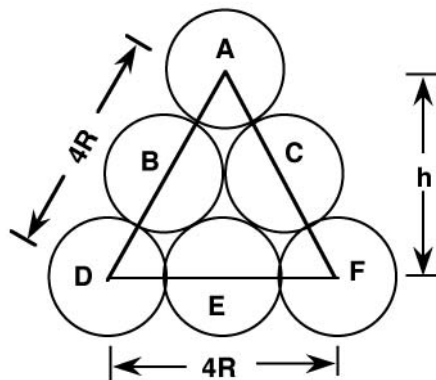

There are six atoms whose centers lie on this plane, which are labeled **A** through **F**. One-sixth of each of atoms **A**, **D**, and **F** are associated with this plane (yielding an equivalence of one-half atom), with one-half of each of atoms **B**, **C**, and **E** (or an equivalence of one and one-half atoms) for a total equivalence of two atoms. Now, the area of the triangle shown in the above figure is equal to one-half of the product of the base length and the height, **h**. If we consider half of the triangle, then



$$(2R)^2 + h^2 = (4R)^2$$

which leads to  $h = 2R\sqrt{3}$ . Thus, the area is equal to

$$\text{Area} = \frac{4R(h)}{2} = \frac{(4R)(2R\sqrt{3})}{2} = 4R^2\sqrt{3}$$

And, thus, the planar density is

$$\begin{aligned} \text{PD}_{111} &= \frac{\text{number of atoms centered on (111) plane}}{\text{area of (111) plane}} \\ &= \frac{2 \text{ atoms}}{4R^2\sqrt{3}} = \frac{1}{2R^2\sqrt{3}} \end{aligned}$$

(b) From the table inside the front cover, the atomic radius for aluminum is 0.143 nm. Therefore, the planar density for the (100) plane is

$$\text{PD}_{100}(\text{Al}) = \frac{1}{4R^2} = \frac{1}{4(0.143 \text{ nm})^2} = 12.23 \text{ nm}^{-2} = 1.223 \times 10^{-17} \text{ m}^{-2}$$

While for the (111) plane

$$\text{PD}_{111}(\text{Al}) = \frac{1}{2R^2\sqrt{3}} = \frac{1}{2\sqrt{3}(0.143 \text{ nm})^2} = 14.12 \text{ nm}^{-2} = 1.412 \times 10^{-17} \text{ m}^{-2}$$

3.48 (a) A BCC unit cell within which is drawn a [100] plane is shown below.

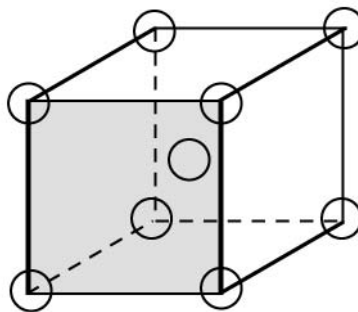

For this (100) plane there is one atom at each of the four cube corners, each of which is shared with four adjacent unit cells. Thus, there is the equivalence of 1 atom associated with this BCC (100) plane. The planar section represented in the above figure is a square, wherein the side lengths are

equal to the unit cell edge length,  $\frac{4R}{\sqrt{3}}$  [Equation (3.3)]; and, thus, the area of this square is just

$$\left(\frac{4R}{\sqrt{3}}\right)^2 = \frac{16R^2}{3}. \text{ Hence, the planar density for this (100) plane is just}$$

$$\begin{aligned} PD_{100} &= \frac{\text{number of atoms centered on (100) plane}}{\text{area of (100) plane}} \\ &= \frac{1 \text{ atom}}{\frac{16R^2}{3}} = \frac{3}{16R^2} \end{aligned}$$

A BCC unit cell within which is drawn a [110] plane is shown below.

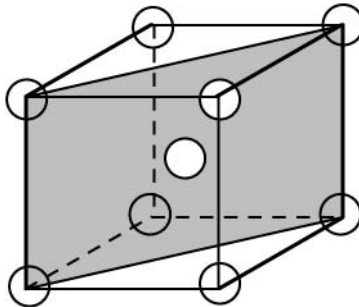

For this (110) plane there is one atom at each of the four cube corners through which it passes, each of which is shared with four adjacent unit cells, while the center atom lies entirely within the unit cell. Thus, there is the equivalence of 2 atoms associated with this BCC (110) plane. The planar section represented in the above figure is a rectangle, as noted in the figure below.

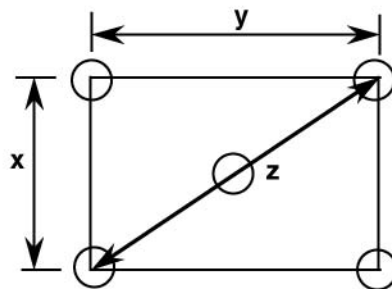

From this figure, the area of the rectangle is the product of  $x$  and  $y$ . The length  $x$  is just the unit cell edge length, which for BCC [Equation (3.3)] is  $\frac{4R}{\sqrt{3}}$ . Now, the diagonal length  $z$  is equal to  $4R$ . For the triangle bounded by the lengths  $x$ ,  $y$ , and  $z$

$$y = \sqrt{z^2 - x^2}$$

Or

$$y = \sqrt{(4R)^2 - \left(\frac{4R}{\sqrt{3}}\right)^2} = \frac{4R\sqrt{2}}{\sqrt{3}}$$

Thus, in terms of  $R$ , the area of this (110) plane is just

$$\text{Area}(110) = xy = \left(\frac{4R}{\sqrt{3}}\right)\left(\frac{4R\sqrt{2}}{\sqrt{3}}\right) = \frac{16R^2\sqrt{2}}{3}$$

And, finally, the planar density for this (110) plane is just

$$\begin{aligned} \text{PD}_{110} &= \frac{\text{number of atoms centered on (110) plane}}{\text{area of (110) plane}} \\ &= \frac{2 \text{ atoms}}{\frac{16R^2\sqrt{2}}{3}} = \frac{3}{8R^2\sqrt{2}} \end{aligned}$$

(b) From the table inside the front cover, the atomic radius for molybdenum is 0.136 nm. Therefore, the planar density for the (100) plane is

$$\text{PD}_{100}(\text{Mo}) = \frac{3}{16R^2} = \frac{3}{16(0.136 \text{ nm})^2} = 10.14 \text{ nm}^{-2} = 1.014 \times 10^{-17} \text{ m}^{-2}$$

While for the (110) plane

$$\text{PD}_{110}(\text{Mo}) = \frac{3}{8R^2\sqrt{2}} = \frac{3}{8(0.136 \text{ nm})^2\sqrt{2}} = 14.34 \text{ nm}^{-2} = 1.434 \times 10^{-17} \text{ m}^{-2}$$

3.49 (a) A (0001) plane for an HCP unit cell is show below.

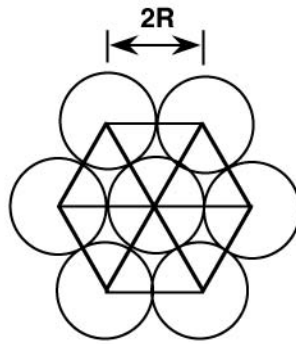

Each of the 6 perimeter atoms in this plane is shared with three other unit cells, whereas the center atom is shared with no other unit cells; this gives rise to three equivalent atoms belonging to this plane.

In terms of the atomic radius  $R$ , the area of each of the 6 equilateral triangles that have been drawn is  $R^2\sqrt{3}$ , or the total area of the plane shown is  $6R^2\sqrt{3}$ . And the planar density for this (0001) plane is equal to

$$\begin{aligned}
 PD_{0001} &= \frac{\text{number of atoms centered on (0001) plane}}{\text{area of (0001) plane}} \\
 &= \frac{3 \text{ atoms}}{6R^2\sqrt{3}} = \frac{1}{2R^2\sqrt{3}}
 \end{aligned}$$

(b) From the table inside the front cover, the atomic radius for titanium is 0.145 nm. Therefore, the planar density for the (0001) plane is

$$PD_{0001}(\text{Ti}) = \frac{1}{2R^2\sqrt{3}} = \frac{1}{2\sqrt{3}(0.145 \text{ nm})^2} = 13.73 \text{ nm}^{-2} = 1.373 \times 10^{-17} \text{ m}^{-2}$$

3.50 Unit cells are constructed below from the three crystallographic planes provided in the problem.

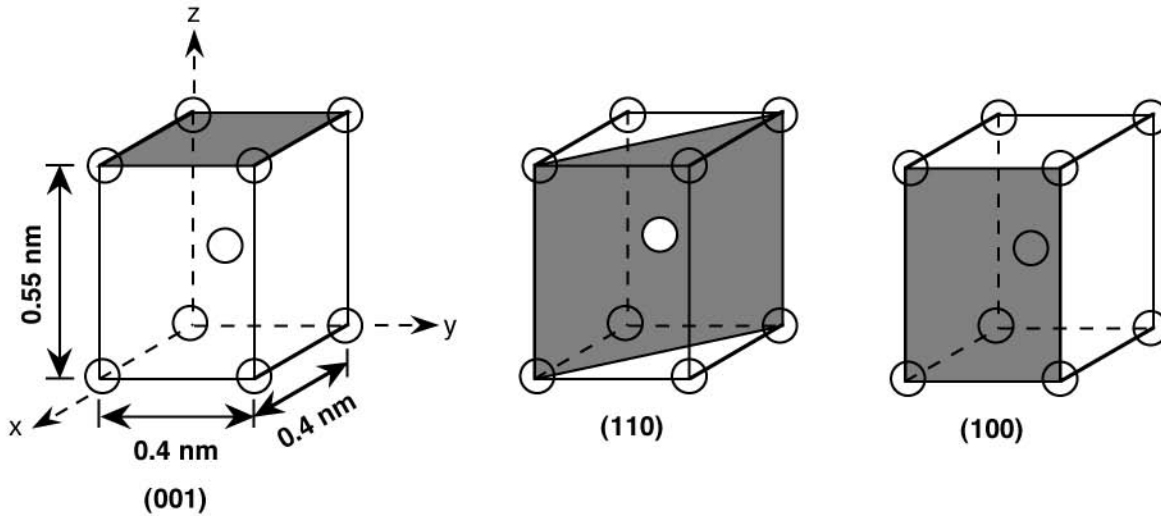

(a) This unit cell belongs to the tetragonal system since  $a = b = 0.40 \text{ nm}$ ,  $c = 0.55 \text{ nm}$ , and  $\alpha = \beta = \gamma = 90^\circ$ .

(b) This crystal structure would be called body-centered tetragonal since the unit cell has tetragonal symmetry, and an atom is located at each of the corners, as well as the cell center.

3.51 The unit cells constructed below show the three crystallographic planes that were provided in the problem.

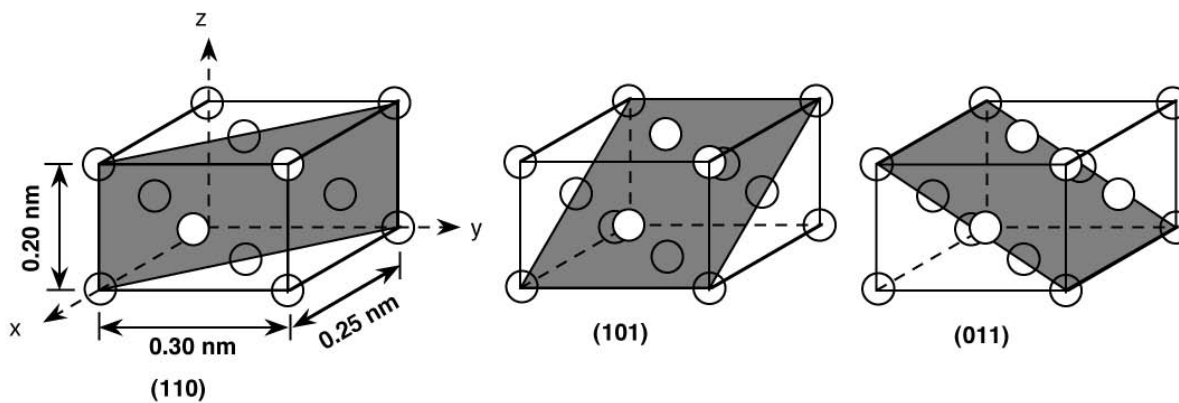

(a) This unit cell belongs to the orthorhombic crystal system since  $a = 0.25 \text{ nm}$ ,  $b = 0.30 \text{ nm}$ ,  $c = 0.20 \text{ nm}$ , and  $\alpha = \beta = \gamma = 90^\circ$ .

(b) This crystal structure would be called face-centered orthorhombic since the unit cell has orthorhombic symmetry, and an atom is located at each of the corners, as well as at each of the face centers.

(c) In order to compute its atomic weight, we employ Equation (3.5), with  $n = 4$ ; thus

$$A = \frac{\rho V_C N_A}{n}$$

$$= \frac{(18.91 \text{ g/cm}^3)(2.0)(2.5)(3.0) \left( \times 10^{-24} \text{ cm}^3/\text{unit cell} \right) (6.023 \times 10^{23} \text{ atoms/mol})}{4 \text{ atoms/unit cell}}$$

$$= 42.7 \text{ g/mol}$$

3.52 Although each individual grain in a polycrystalline material may be anisotropic, if the grains have random orientations, then the solid aggregate of the many anisotropic grains will behave isotropically.

3.53W From the table, aluminum has an FCC crystal structure and an atomic radius of 0.1431 nm. Using Equation (3.1), the lattice parameter **a** may be computed as

$$a = 2R\sqrt{2} = (2)(0.1431 \text{ nm})\sqrt{2} = 0.4048 \text{ nm}$$

Now, the interplanar spacing **d<sub>110</sub>** maybe determined using Equation (3.3W) as

$$d_{110} = \frac{a}{\sqrt{(1)^2 + (1)^2 + (0)^2}} = \frac{0.4048 \text{ nm}}{\sqrt{2}} = 0.2862 \text{ nm}$$

3.54W We must first calculate the lattice parameter using Equation (3.3) and the value of **R** cited in Table 3.1 as

$$a = \frac{4R}{\sqrt{3}} = \frac{(4)(0.1249 \text{ nm})}{\sqrt{3}} = 0.2884 \text{ nm}$$

Next, the interplanar spacing may be determined using Equation (3.3W) according to

$$d_{310} = \frac{a}{\sqrt{(3)^2 + (1)^2 + (0)^2}} = \frac{0.2884 \text{ nm}}{\sqrt{10}} = 0.0912 \text{ nm}$$

And finally, employment of Equation (3.2W) yields

$$\sin \theta = \frac{n\lambda}{2d} = \frac{(1)(0.0711 \text{ nm})}{(2)(0.0912 \text{ nm})} = 0.390$$

$$\theta = \sin^{-1}(0.390) = 22.94^\circ$$

And

$$2\theta = (2)(22.94^\circ) = 45.88^\circ$$

3.55W From the table,  $\alpha$ -iron has a BCC crystal structure and an atomic radius of 0.1241 nm. Using Equation (3.3) the lattice parameter,  $a$ , may be computed as

$$a = \frac{4R}{\sqrt{3}} = \frac{(4)(0.1241 \text{ nm})}{\sqrt{3}} = 0.2866 \text{ nm}$$

Now, the  $d_{111}$  interplanar spacing may be determined using Equation (3.3W) as

$$d_{111} = \frac{a}{\sqrt{(1)^2 + (1)^2 + (1)^2}} = \frac{0.2866 \text{ nm}}{\sqrt{3}} = 0.1655 \text{ nm}$$

And, similarly for  $d_{211}$

$$d_{211} = \frac{a}{\sqrt{(2)^2 + (1)^2 + (1)^2}} = \frac{0.2866 \text{ nm}}{\sqrt{6}} = 0.1170 \text{ nm}$$

3.56W (a) From the data given in the problem, and realizing that  $36.12^\circ = 2\theta$ , the interplanar spacing for the (311) set of planes may be computed using Equation (3.3W) as

$$d_{311} = \frac{n\lambda}{2 \sin \theta} = \frac{(1)(0.0711 \text{ nm})}{(2) \left( \sin \frac{36.12^\circ}{2} \right)} = 0.1147 \text{ nm}$$

(b) In order to compute the atomic radius we must first determine the lattice parameter,  $a$ , using Equation (3.3W), and then  $R$  from Equation (3.1) since Rh has an FCC crystal structure. Therefore,

$$a = d_{311} \sqrt{(3)^2 + (1)^2 + (1)^2} = (0.1147 \text{ nm})(\sqrt{11}) = 0.3804 \text{ nm}$$

And

$$R = \frac{a}{2\sqrt{2}} = \frac{0.3804 \text{ nm}}{2\sqrt{2}} = 0.1345 \text{ nm}$$

3.57W. (a) From the data given in the problem, and realizing that  $75.99^\circ = 2\theta$ , the interplanar spacing for the (211) set of planes may be computed using Equation (3.2W) as

$$d_{211} = \frac{n\lambda}{2 \sin \theta} = \frac{(1)(0.1659 \text{ nm})}{(2)\left(\sin \frac{75.99^\circ}{2}\right)} = 0.1348 \text{ nm}$$

(b) In order to compute the atomic radius we must first determine the lattice parameter, **a**, using Equation (3.3W), and then **R** from Equation (3.3) since Nb has a BCC crystal structure. Therefore,

$$a = d_{211}\sqrt{(2)^2 + (1)^2 + (1)^2} = (0.1347 \text{ nm})(\sqrt{6}) = 0.3300 \text{ nm}$$

And

$$R = \frac{a\sqrt{3}}{4} = \frac{(0.3300 \text{ nm})\sqrt{3}}{4} = 0.1429 \text{ nm}$$

3.58W The first step to solve this problem is to compute the interplanar spacing using Equation (3.2W). Thus,

$$d_{hkl} = \frac{n\lambda}{2 \sin \theta} = \frac{(1)(0.1542 \text{ nm})}{(2)\left(\sin \frac{44.53^\circ}{2}\right)} = 0.2035 \text{ nm}$$

Now, employment of both Equations (3.3W) and (3.1), and the value of **R** for nickel from Table 3.1 (0.1246 nm) leads to

$$\begin{aligned} \sqrt{h^2 + k^2 + l^2} &= \frac{a}{d_{hkl}} = \frac{2R\sqrt{2}}{d_{hkl}} \\ &= \frac{(2)(0.1246 \text{ nm})\sqrt{2}}{(0.2035 \text{ nm})} = 1.732 \end{aligned}$$

This means that



$$h^2 + k^2 + l^2 = (1.732)^2 = 3.0$$

By trial and error, the only three integers which are all odd or even, the sum of the squares of which equals 3.0 are 1, 1, and 1. Therefore, the set of planes responsible for this diffraction peak is the (111) set.

3.59W For each peak, in order to compute the interplanar spacing and the lattice parameter we must employ Equations (3.3W) and (3.2W), respectively. For the first peak which occurs at  $31.3^\circ$

$$d_{111} = \frac{n\lambda}{2 \sin \theta} = \frac{(1)(0.1542 \text{ nm})}{(2) \left( \sin \frac{31.3^\circ}{2} \right)} = 0.2858 \text{ nm}$$

And

$$\begin{aligned} a &= d_{hkl} \sqrt{(h)^2 + (k)^2 + (l)^2} = d_{111} \sqrt{(1)^2 + (1)^2 + (1)^2} \\ &= (0.2858 \text{ nm}) \sqrt{3} = 0.4950 \text{ nm} \end{aligned}$$

Similar computations are made for the other peaks which results are tabulated below:

<u>Peak Index</u>	<u><math>2\theta</math></u>	<u><math>d_{hkl}(\text{nm})</math></u>	<u><math>a(\text{nm})</math></u>
200	36.6	0.2455	0.4910
220	52.6	0.1740	0.4921
311	62.5	0.1486	0.4929
222	65.5	0.1425	0.4936

3.60W The first four diffraction peaks that will occur for BCC consistent with  $h + k + l$  being even are (110), (200), (211), and (220).

3.61W (a) Since W has a BCC crystal structure, only those peaks for which  $h + k + l$  are even will appear. Therefore, the first peak results by diffraction from (110) planes.

(b) For each peak, in order to calculate the interplanar spacing we must employ Equation (3.2W). For the first peak which occurs at  $40.2^\circ$

$$d_{110} = \frac{n\lambda}{2 \sin \theta} = \frac{(1)(0.1542 \text{ nm})}{(2) \left( \sin \frac{40.2^\circ}{2} \right)} = 0.2244 \text{ nm}$$

(c) Employment of Equations (3.3W) and (3.3) is necessary for the computation of **R** for W as

$$\begin{aligned} R &= \frac{a\sqrt{3}}{4} = \frac{(d_{hkl})(\sqrt{3})\sqrt{(h)^2 + (k)^2 + (l)^2}}{4} \\ &= \frac{(0.2244 \text{ nm})(\sqrt{3})\sqrt{(1)^2 + (1)^2 + (0)^2}}{4} \\ &= 0.1374 \text{ nm} \end{aligned}$$

3.62 A material in which atomic bonding is predominantly ionic in nature is less likely to form a noncrystalline solid upon solidification than a covalent material because covalent bonds are directional whereas ionic bonds are nondirectional; it is more difficult for the atoms in a covalent material to assume positions giving rise to an ordered structure.

## CHAPTER 4

### IMPERFECTIONS IN SOLIDS

#### PROBLEM SOLUTIONS

- 4.1 In order to compute the fraction of atom sites that are vacant in lead at 600 K, we must employ Equation (4.1). As stated in the problem,  $Q_V = 0.55$  eV/atom. Thus,

$$\begin{aligned} \frac{N_V}{N} &= \exp\left(-\frac{Q_V}{kT}\right) = \exp\left[-\frac{0.55 \text{ eV/atom}}{(8.62 \times 10^{-5} \text{ eV/atom-K})(600 \text{ K})}\right] \\ &= 2.41 \times 10^{-5} \end{aligned}$$

- 4.2 Determination of the number of vacancies per cubic meter in gold at 900°C (1173 K) requires the utilization of Equations (4.1) and (4.2) as follows:

$$\begin{aligned} N_V &= N \exp\left(-\frac{Q_V}{kT}\right) = \frac{N_A \rho_{Au}}{A_{Au}} \exp\left(-\frac{Q_V}{kT}\right) \\ &= \frac{(6.023 \times 10^{23} \text{ atoms/mol})(19.32 \text{ g/cm}^3)}{196.9 \text{ g/mol}} \exp\left[-\frac{0.98 \text{ eV/atom}}{(8.62 \times 10^{-5} \text{ eV/atom-K})(1173 \text{ K})}\right] \\ &= 3.65 \times 10^{18} \text{ cm}^{-3} = 3.65 \times 10^{24} \text{ m}^{-3} \end{aligned}$$

- 4.3 This problem calls for the computation of the energy for vacancy formation in silver. Upon examination of Equation (4.1), all parameters besides  $Q_V$  are given except  $N$ , the total number of atomic sites. However,  $N$  is related to the density, ( $\rho$ ), Avogadro's number ( $N_A$ ), and the atomic weight ( $A$ ) according to Equation (4.2) as

$$\begin{aligned} N &= \frac{N_A \rho_{Ag}}{A_{Ag}} \\ &= \frac{(6.023 \times 10^{23} \text{ atoms/mol})(10.49 \text{ g/cm}^3)}{107.87 \text{ g/mol}} \end{aligned}$$

$$= 5.86 \times 10^{22} \text{ atoms/cm}^3 = 5.86 \times 10^{28} \text{ atoms/m}^3$$

Now, taking natural logarithms of both sides of Equation (4.1), and, after some algebraic manipulation

$$Q_V = - RT \ln \left( \frac{N_V}{N} \right)$$

$$= - \left( 8.62 \times 10^{-5} \text{ eV/atom-K} \right) (1073 \text{ K}) \ln \left[ \frac{3.60 \times 10^{23} \text{ m}^{-3}}{5.86 \times 10^{28} \text{ m}^{-3}} \right]$$

$$= 1.11 \text{ eV/atom}$$

4.4 In this problem we are asked to cite which of the elements listed form with Cu the three possible solid solution types. For complete substitutional solubility the following criteria must be met: 1) the difference in atomic radii between Cu and the other element ( $\Delta R\%$ ) must be less than  $\pm 15\%$ , 2) the crystal structures must be the same, 3) the electronegativities must be similar, and 4) the valences should be the same, or nearly the same. Below are tabulated, for the various elements, these criteria.

<u>Element</u>	<u><math>\Delta R\%</math></u>	<u>Crystal Structure</u>	<u><math>\Delta</math>Electro-negativity</u>	<u>Valence</u>
<b>Cu</b>		<b>FCC</b>		<b>2+</b>
C	-44			
H	-64			
O	-53			
Ag	+13	FCC	0	1+
Al	+12	FCC	-0.4	3+
Co	-2	HCP	-0.1	2+
Cr	-2	BCC	-0.3	3+
Fe	-3	BCC	-0.1	2+
Ni	-3	FCC	-0.1	2+
Pd	+8	FCC	+0.3	2+
Pt	+9	FCC	+0.3	2+
Zn	+4	HCP	-0.3	2+

- (a) Ni, Pd, and Pt meet all of the criteria and thus form substitutional solid solutions having complete solubility.
- (b) Ag, Al, Co, Cr, Fe, and Zn form substitutional solid solutions of incomplete solubility. All these metals have either BCC or HCP crystal structures, and/or the difference between their atomic radii and that for Cu are greater than  $\pm 15\%$ , and/or have a valence different than 2+.
- (c) C, H, and O form interstitial solid solutions. These elements have atomic radii that are significantly smaller than the atomic radius of Cu.

4.5 In the drawing below is shown the atoms on the (100) face of an FCC unit cell; the interstitial site is at the center of the edge.

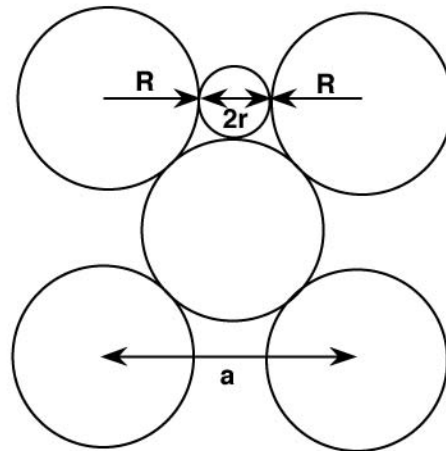

The diameter of an atom that will just fit into this site ( $2r$ ) is just the difference between the unit cell edge length ( $a$ ) and the radii of the two host atoms that are located on either side of the site ( $R$ ); that is

$$2r = a - 2R$$

However, for FCC  $a$  is related to  $R$  according to Equation (3.1) as  $a = 2R\sqrt{2}$ ; therefore, solving for  $r$  gives

$$r = \frac{a - 2R}{2} = \frac{2R\sqrt{2} - 2R}{2} = 0.41R$$

A (100) face of a BCC unit cell is shown below.

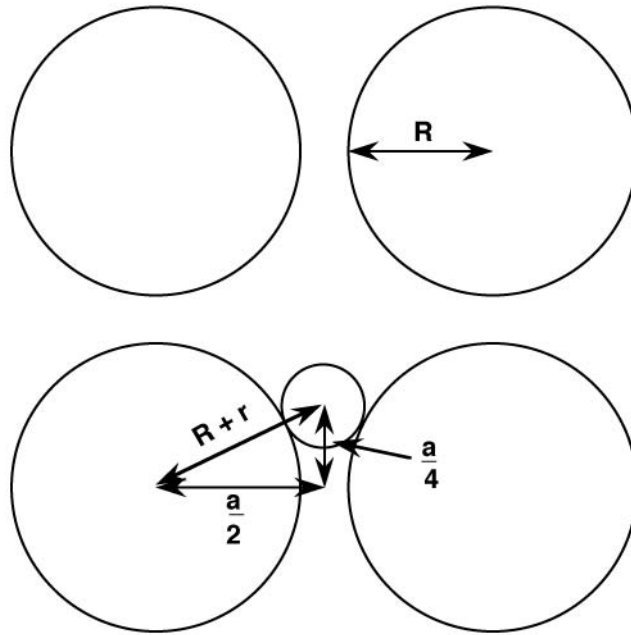

The interstitial atom that just fits into this interstitial site is shown by the small circle. It is situated in the plane of this (100) face, midway between the two vertical unit cell edges, and one quarter of the distance between the bottom and top cell edges. From the right triangle that is defined by the three arrows we may write

$$\left(\frac{a}{2}\right)^2 + \left(\frac{a}{4}\right)^2 = (R + r)^2$$

However, from Equation (3.3),  $a = \frac{4R}{\sqrt{3}}$ , and, therefore, the above equation takes the form

$$\left(\frac{4R}{2\sqrt{3}}\right)^2 + \left(\frac{4R}{4\sqrt{3}}\right)^2 = R^2 + 2Rr + r^2$$

After rearrangement the following quadratic equation results:

$$r^2 + 2Rr - 0.667R^2 = 0$$

And upon solving for  $r$ ,  $r = 0.291R$ .

Thus, for a host atom of radius  $R$ , the size of an interstitial site for FCC is approximately 1.4 times that for BCC.

4.6 (a) This problem asks that we derive Equation (4.7a). To begin,  $C_1$  is defined according to Equation (4.3) as

$$C_1 = \frac{m_1}{m_1 + m_2} \times 100$$

or, equivalently

$$C_1 = \frac{m'_1}{m'_1 + m'_2} \times 100$$

where the primed  $m$ 's indicate masses in grams. From Equation (4.4) we may write

$$m'_1 = n_{m1} A_1$$

$$m'_2 = n_{m2} A_2$$

And, substitution into the  $C_1$  expression

$$C_1 = \frac{n_{m1} A_1}{n_{m1} A_1 + n_{m2} A_2} \times 100$$

From Equation (4.5) it is the case that

$$n_{m1} = \frac{C_1 (n_{m1} + n_{m2})}{100}$$

$$n_{m2} = \frac{C_2 (n_{m1} + n_{m2})}{100}$$

And substitution of these expressions into the above equation leads to

$$C_1 = \frac{C_1' A_1}{C_1' A_1 + C_2' A_2} \times 100$$

which is just Equation (4.7a).

(b) This problem asks that we derive Equation (4.9a). To begin,  $C_1''$  is defined as the mass of component 1 per unit volume of alloy, or

$$C_1'' = \frac{m_1}{V}$$

If we assume that the total alloy volume  $V$  is equal to the sum of the volumes of the two constituents--i.e.,  $V = V_1 + V_2$ --then

$$C_1'' = \frac{m_1}{V_1 + V_2}$$

Furthermore, the volume of each constituent is related to its density and mass as

$$V_1 = \frac{m_1}{\rho_1}$$

$$V_2 = \frac{m_2}{\rho_2}$$

This leads to

$$C_1'' = \frac{m_1}{\frac{m_1}{\rho_1} + \frac{m_2}{\rho_2}}$$

From Equation (4.3),  $m_1$  and  $m_2$  may be expressed as follows:

$$m_1 = \frac{C_1(m_1 + m_2)}{100}$$



$$m_2 = \frac{C_2(m_1 + m_2)}{100}$$

Substitution of these equations into the preceding expression yields

$$C_1'' = \frac{\frac{C_1(m_1 + m_2)}{100}}{\frac{C_1(m_1 + m_2)}{100\rho_1} + \frac{C_2(m_1 + m_2)}{100\rho_2}}$$

$$= \frac{C_1}{\frac{C_1}{\rho_1} + \frac{C_2}{\rho_2}}$$

If the densities  $\rho_1$  and  $\rho_2$  are given in units of  $\text{g/cm}^3$ , then conversion to units of  $\text{kg/m}^3$  requires that we multiply this equation by  $10^3$ , inasmuch as

$$10^3 \text{ g/cm}^3 = 1 \text{ kg/m}^3$$

Therefore, the previous equation takes the form

$$C_1'' = \frac{C_1}{\frac{C_1}{\rho_1} + \frac{C_2}{\rho_2}} \times 10^3$$

which is the desired expression.

- (c) Now we are asked to derive Equation (4.10a). The density of an alloy  $\rho_{\text{ave}}$  is just the total alloy mass **M** divided by its volume **V**

$$\rho_{\text{ave}} = \frac{M}{V}$$

Or, in terms of the component elements 1 and 2

$$\rho_{ave} = \frac{m_1 + m_2}{V_1 + V_2}$$

Here it is assumed that the total alloy volume is equal to the separate volumes of the individual components, which is only an approximation; normally  $V$  will not be exactly equal to  $(V_1 + V_2)$ . Each of  $V_1$  and  $V_2$  may be expressed in terms of its mass density, which when substituted into the above equation

$$\rho_{ave} = \frac{m_1 + m_2}{\frac{m_1}{\rho_1} + \frac{m_2}{\rho_2}}$$

Furthermore, from Equation (4.3)

$$m_1 = \frac{C_1(m_1 + m_2)}{100}$$

$$m_2 = \frac{C_2(m_1 + m_2)}{100}$$

Which, when substituted into the above  $\rho_{ave}$  expression yields

$$\begin{aligned} \rho_{ave} &= \frac{m_1 + m_2}{\frac{C_1(m_1 + m_2)}{100\rho_1} + \frac{C_2(m_1 + m_2)}{100\rho_2}} \\ &= \frac{100}{\frac{C_1}{\rho_1} + \frac{C_2}{\rho_2}} \end{aligned}$$

(d) And, finally, the derivation of Equation (4.11b) for  $A_{ave}$  is requested. The alloy average molecular weight is just the ratio of total alloy mass in grams  $M'$  and the total number of moles in the alloy  $N_m$ . That is

$$A_{ave} = \frac{M'}{N_m} = \frac{m'_1 + m'_2}{n_{m1} + n_{m2}}$$

But using Equation (4.4) we may write

$$m_1' = n_{m1} A_1$$

$$m_2' = n_{m2} A_2$$

Which, when substituted into the above  $A_{ave}$  expression yields

$$A_{ave} = \frac{M'}{N_m} = \frac{n_{m1} A_1 + n_{m2} A_2}{n_{m1} + n_{m2}}$$

Furthermore, from Equation (4.5)

$$n_{m1} = \frac{C_1' (n_{m1} + n_{m2})}{100}$$

$$n_{m2} = \frac{C_2' (n_{m1} + n_{m2})}{100}$$

Thus

$$A_{ave} = \frac{\frac{C_1' A_1 (n_{m1} + n_{m2})}{100} + \frac{C_2' A_2 (n_{m1} + n_{m2})}{100}}{n_{m1} + n_{m2}}$$

$$= \frac{C_1' A_1 + C_2' A_2}{100}$$

which is the desired result.

4.7 In order to compute composition, in atom percent, of a 92.5 wt% Ag-7.5 wt% Cu alloy, we employ Equation (4.6) as

$$C_{Ag}' = \frac{C_{Ag} A_{Cu}}{C_{Ag} A_{Cu} + C_{Cu} A_{Ag}} \times 100$$

$$= \frac{(92.5)(63.55 \text{ g/mol})}{(92.5)(63.55 \text{ g/mol}) + (7.5)(107.87\text{g/mol})} \times 100$$

$$= 87.9 \text{ at\%}$$

$$C'_{\text{Cu}} = \frac{C_{\text{Cu}} A_{\text{Ag}}}{C_{\text{Ag}} A_{\text{Cu}} + C_{\text{Cu}} A_{\text{Ag}}} \times 100$$

$$= \frac{(7.5)(107.87 \text{ g/mol})}{(92.5)(63.55 \text{ g/mol}) + (7.5)(107.87\text{g/mol})} \times 100$$

$$= 12.1 \text{ at\%}$$

4.8 In order to compute composition, in weight percent, of a 5 at% Cu-95 at% Pt alloy, we employ Equation (4.7) as

$$C_{\text{Cu}} = \frac{C'_{\text{Cu}} A_{\text{Cu}}}{C'_{\text{Cu}} A_{\text{Cu}} + C'_{\text{Pt}} A_{\text{Pt}}} \times 100$$

$$= \frac{(5)(63.55 \text{ g/mol})}{(5)(63.55 \text{ g/mol}) + (95)(195.08 \text{ g/mol})} \times 100$$

$$= 1.68 \text{ wt\%}$$

$$C_{\text{Pt}} = \frac{C'_{\text{Pt}} A_{\text{Pt}}}{C'_{\text{Cu}} A_{\text{Cu}} + C'_{\text{Pt}} A_{\text{Pt}}} \times 100$$

$$= \frac{(95)(195.08 \text{ g/mol})}{(5)(63.55 \text{ g/mol}) + (95)(195.08 \text{ g/mol})} \times 100$$

$$= 98.32 \text{ wt\%}$$

4.9 The concentration, in weight percent, of an element in an alloy may be computed using a modification of Equation (4.3). For this alloy, the concentration of iron ( $C_{\text{Fe}}$ ) is just

$$C_{\text{Fe}} = \frac{m_{\text{Fe}}}{m_{\text{Fe}} + m_{\text{C}} + m_{\text{Cr}}} \times 100$$

$$= \frac{105 \text{ kg}}{105 \text{ kg} + 0.2 \text{ kg} + 1.0 \text{ kg}} \times 100 = 98.87 \text{ wt\%}$$

Similarly, for carbon

$$C_{\text{C}} = \frac{0.2 \text{ kg}}{105 \text{ kg} + 0.2 \text{ kg} + 1.0 \text{ kg}} \times 100 = 0.19 \text{ wt\%}$$

And for chromium

$$C_{\text{Cr}} = \frac{1.0 \text{ kg}}{105 \text{ kg} + 0.2 \text{ kg} + 1.0 \text{ kg}} \times 100 = 0.94 \text{ wt\%}$$

4.10 The concentration of an element in an alloy, in atom percent, may be computed using Equation (4.5). With this problem, it first becomes necessary to compute the number of moles of both Cu and Zn, for which Equation (4.4) is employed. Thus, the number of moles of Cu is just

$$n_{m_{\text{Cu}}} = \frac{m'_{\text{Cu}}}{A_{\text{Cu}}} = \frac{33 \text{ g}}{63.55 \text{ g/mol}} = 0.519 \text{ mol}$$

Likewise, for Zn

$$n_{m_{\text{Zn}}} = \frac{47 \text{ g}}{65.39 \text{ g/mol}} = 0.719 \text{ mol}$$

Now, use of Equation (4.5) yields

$$C'_{\text{Cu}} = \frac{n_{m_{\text{Cu}}}}{n_{m_{\text{Cu}}} + n_{m_{\text{Zn}}}} \times 100$$

$$= \frac{0.519 \text{ mol}}{0.519 \text{ mol} + 0.719 \text{ mol}} \times 100 = 41.9 \text{ at\%}$$

Also,

$$C'_{\text{Zn}} = \frac{0.719 \text{ mol}}{0.519 \text{ mol} + 0.719 \text{ mol}} \times 100 = 58.1 \text{ at\%}$$

4.11 In this problem we are asked to determine the concentrations, in atom percent, of the Ag-Au-Cu alloy. It is first necessary to convert the amounts of Ag, Au, and Cu into grams.

$$m'_{\text{Ag}} = (44.5 \text{ lb}_m)(453.6 \text{ g/lb}_m) = 20,185 \text{ g}$$

$$m'_{\text{Au}} = (83.7 \text{ lb}_m)(453.6 \text{ g/lb}_m) = 37,966 \text{ g}$$

$$m'_{\text{Cu}} = (5.3 \text{ lb}_m)(453.6 \text{ g/lb}_m) = 2,404 \text{ g}$$

These masses must next be converted into moles [Equation (4.4)], as

$$n_{\text{mAg}} = \frac{m'_{\text{Ag}}}{A_{\text{Ag}}} = \frac{20,185 \text{ g}}{107.87 \text{ g/mol}} = 187.1 \text{ mol}$$

$$n_{\text{mAu}} = \frac{37,966 \text{ g}}{196.97 \text{ g/mol}} = 192.8 \text{ mol}$$

$$n_{\text{mCu}} = \frac{2,404 \text{ g}}{63.55 \text{ g/mol}} = 37.8 \text{ mol}$$

Now, employment of a modified form of Equation (4.5)

$$C'_{\text{Ag}} = \frac{n_{\text{mAg}}}{n_{\text{mAg}} + n_{\text{mAu}} + n_{\text{mCu}}} \times 100$$

$$= \frac{187.1 \text{ mol}}{187.1 \text{ mol} + 192.8 \text{ mol} + 37.8 \text{ mol}} \times 100 = 44.8 \text{ at\%}$$

$$C'_{\text{Au}} = \frac{192.8 \text{ mol}}{187.1 \text{ mol} + 192.8 \text{ mol} + 37.8 \text{ mol}} \times 100 = 46.2 \text{ at\%}$$

$$C'_{\text{Cu}} = \frac{37.8 \text{ mol}}{187.1 \text{ mol} + 192.8 \text{ mol} + 37.8 \text{ mol}} \times 100 = 9.0 \text{ at\%}$$

4.12 We are asked to compute the composition of an alloy in atom percent. Employment of Equation (4.6) leads to

$$C'_{\text{Pb}} = \frac{C_{\text{Pb}} A_{\text{Sn}}}{C_{\text{Pb}} A_{\text{Sn}} + C_{\text{Sn}} A_{\text{Pb}}} \times 100$$

$$= \frac{5.5(118.69 \text{ g/mol})}{5.5(118.69 \text{ g/mol}) + 94.5(207.2 \text{ g/mol})} \times 100$$

$$= 3.2 \text{ at\%}$$

$$C'_{\text{Sn}} = \frac{C_{\text{Sn}} A_{\text{Pb}}}{C_{\text{Sn}} A_{\text{Pb}} + C_{\text{Pb}} A_{\text{Sn}}} \times 100$$

$$= \frac{94.5(207.2 \text{ g/mol})}{94.5(207.2 \text{ g/mol}) + 5.5(118.69 \text{ g/mol})} \times 100$$

$$= 96.8 \text{ at\%}$$

4.13 This problem calls for a conversion of composition in atom percent to composition in weight percent. The composition in atom percent for Problem 4.11 is 44.8 at% Ag, 46.2 at% Au, and 9.0 at% Cu. Modification of Equation (4.7) to take into account a three-component alloy leads to the following

$$C_{\text{Ag}} = \frac{C'_{\text{Ag}} A_{\text{Ag}}}{C'_{\text{Ag}} A_{\text{Ag}} + C'_{\text{Au}} A_{\text{Au}} + C'_{\text{Cu}} A_{\text{Cu}}} \times 100$$

$$= \frac{(44.8)(107.87 \text{ g/mol})}{(44.8)(107.87 \text{ g/mol}) + (46.2)(196.97 \text{ g/mol}) + (9.0)(63.55 \text{ g/mol})} \times 100$$

$$= 33.3 \text{ wt\%}$$

$$C_{\text{Au}} = \frac{C'_{\text{Au}} A_{\text{Au}}}{C'_{\text{Ag}} A_{\text{Ag}} + C'_{\text{Au}} A_{\text{Au}} + C'_{\text{Cu}} A_{\text{Cu}}} \times 100$$

$$= \frac{(46.2)(196.97 \text{ g/mol})}{(44.8)(107.87 \text{ g/mol}) + (46.2)(196.97 \text{ g/mol}) + (9.0)(63.55 \text{ g/mol})} \times 100$$

$$= 62.7 \text{ wt\%}$$

$$C_{\text{Cu}} = \frac{C'_{\text{Cu}} A_{\text{Cu}}}{C'_{\text{Ag}} A_{\text{Ag}} + C'_{\text{Au}} A_{\text{Au}} + C'_{\text{Cu}} A_{\text{Cu}}} \times 100$$

$$= \frac{(9.0)(63.55 \text{ g/mol})}{(44.8)(107.87 \text{ g/mol}) + (46.2)(196.97 \text{ g/mol}) + (9.0)(63.55 \text{ g/mol})} \times 100$$

$$= 4.0 \text{ wt\%}$$

4.14 This problem calls for a determination of the number of atoms per cubic meter for aluminum. In order to solve this problem, one must employ Equation (4.2),

$$N = \frac{N_A \rho_{\text{Al}}}{A_{\text{Al}}}$$

The density of Al (from the table inside of the front cover) is  $2.71 \text{ g/cm}^3$ , while its atomic weight is  $26.98 \text{ g/mol}$ . Thus,

$$N = \frac{(6.023 \times 10^{23} \text{ atoms/mol})(2.71 \text{ g/cm}^3)}{26.98 \text{ g/mol}}$$

$$= 6.05 \times 10^{22} \text{ atoms/cm}^3 = 6.05 \times 10^{28} \text{ atoms/m}^3$$

4.15 In order to compute the concentration in  $\text{kg/m}^3$  of Si in a 0.25 wt% Si-99.75 wt% Fe alloy we must employ Equation (4.9) as

$$C''_{\text{Si}} = \frac{C_{\text{Si}}}{\frac{C_{\text{Si}}}{\rho_{\text{Si}}} + \frac{C_{\text{Fe}}}{\rho_{\text{Fe}}}} \times 10^3$$

From inside the front cover, densities for silicon and iron are  $2.33 \text{ g/cm}^3$  and  $7.87 \text{ g/cm}^3$ , respectively; and, therefore

$$C''_{\text{Si}} = \frac{0.25}{\frac{0.25}{2.33 \text{ g/cm}^3} + \frac{99.75}{7.87 \text{ g/cm}^3}} \times 10^3$$



$$= 19.6 \text{ kg/m}^3$$

4.16 We are asked in this problem to determine the approximate density of a high-leaded brass that has a composition of 64.5 wt% Cu, 33.5 wt% Zn, and 2 wt% Pb. In order to solve this problem, Equation (4.10a) is modified to take the following form:

$$\rho_{\text{ave}} = \frac{100}{\frac{C_{\text{Cu}}}{\rho_{\text{Cu}}} + \frac{C_{\text{Zn}}}{\rho_{\text{Zn}}} + \frac{C_{\text{Pb}}}{\rho_{\text{Pb}}}}$$

And, using the density values for Cu, Zn, and Pb that appear inside the front cover of the text, the density is computed as follows:

$$\begin{aligned} \rho_{\text{ave}} &= \frac{100}{\frac{64.5 \text{ wt}\%}{8.94 \text{ g/cm}^3} + \frac{33.5 \text{ wt}\%}{7.13 \text{ g/cm}^3} + \frac{2 \text{ wt}\%}{11.35 \text{ g/cm}^3}} \\ &= 8.27 \text{ g/cm}^3 \end{aligned}$$

4.17 This problem asks that we derive Equation (4.17), using other equations given in the chapter. The concentration of component 1 in atom percent ( $C_1'$ ) is just  $100c_1'$  where  $c_1'$  is the atom fraction of component 1. Furthermore,  $c_1'$  is defined as  $c_1' = N_1/N$  where  $N_1$  and  $N$  are, respectively, the number of atoms of component 1 and total number of atoms per cubic centimeter. Thus, from the above the following holds:

$$N_1 = \frac{C_1' N}{100}$$

Substitution into this expression of the appropriate form of  $N$  from Equation (4.2) yields

$$N_1 = \frac{C_1' N_A \rho_{\text{ave}}}{100 A_{\text{ave}}}$$

Finally, substitution into this equation expressions for  $C_1$  [Equation (4.6a)],  $\rho_{ave}$  [Equation (4.10a)],  $A_{ave}$  [Equation (4.11a)], realizing that  $C_2 = (C_1 - 100)$ , and after some algebraic manipulation we obtain the desired expression:

$$N_1 = \frac{N_A C_1}{\frac{C_1 A_1}{\rho_1} + \frac{A_1}{\rho_2} (100 - C_1)}$$

4.18 This problem asks us to determine the number of molybdenum atoms per cubic centimeter for a 16.4 wt% Mo-83.6 wt% W solid solution. To solve this problem, employment of Equation (4.17) is necessary, using the following values:

$$\begin{aligned} C_1 &= C_{Mo} = 16.4 \text{ wt\%} \\ \rho_1 &= \rho_{Mo} = 10.22 \text{ g/cm}^3 \\ \rho_2 &= \rho_W = 19.3 \text{ g/cm}^3 \\ A_1 &= A_{Mo} = 95.94 \text{ g/mol} \end{aligned}$$

Thus

$$\begin{aligned} N_{Mo} &= \frac{N_A C_{Mo}}{\frac{C_{Mo} A_{Mo}}{\rho_{Mo}} + \frac{A_{Mo}}{\rho_W} (100 - C_{Mo})} \\ &= \frac{(6.023 \times 10^{23} \text{ atoms/mol})(16.4)}{\frac{(16.4)(95.94 \text{ g/mol})}{(10.22 \text{ g/cm}^3)} + \frac{95.94 \text{ g/mol}}{19.3 \text{ g/cm}^3} (100 - 16.4)} \\ &= 1.73 \times 10^{22} \text{ atoms/cm}^3 \end{aligned}$$

4.19 This problem asks us to determine the number of niobium atoms per cubic centimeter for a 24 wt% Nb-76 wt% V solid solution. To solve this problem, employment of Equation (4.17) is necessary, using the following values:

$$\begin{aligned} C_1 &= C_{Nb} = 24 \text{ wt\%} \\ \rho_1 &= \rho_{Nb} = 8.57 \text{ g/cm}^3 \\ \rho_2 &= \rho_V = 6.10 \text{ g/cm}^3 \end{aligned}$$

$$A_1 = A_{\text{Nb}} = 92.91 \text{ g/mol}$$

Thus

$$\begin{aligned} N_{\text{Nb}} &= \frac{N_A C_{\text{Nb}}}{\frac{C_{\text{Nb}} A_{\text{Nb}}}{\rho_{\text{Nb}}} + \frac{A_{\text{Nb}}}{\rho_V} (100 - C_{\text{Nb}})} \\ &= \frac{(6.023 \times 10^{23} \text{ atoms/mol})(24)}{\frac{(24)(92.91 \text{ g/mol})}{(8.57 \text{ g/cm}^3)} + \frac{92.91 \text{ g/mol}}{6.10 \text{ g/cm}^3} (100 - 24)} \\ &= 1.02 \times 10^{22} \text{ atoms/cm}^3 \end{aligned}$$

4.20 This problem asks that we derive Equation (4.18), using other equations given in the chapter. The number of atoms of component 1 per cubic centimeter is just equal to the atom fraction of component 1 ( $c_1'$ ) times the total number of atoms per cubic centimeter in the alloy ( $N$ ). Thus, using the equivalent of Equation (4.2), we may write

$$N_1 = c_1' N = \frac{c_1' N_A \rho_{\text{ave}}}{A_{\text{ave}}}$$

Realizing that

$$c_1' = \frac{C_1'}{100}$$

and

$$C_2' = 100 - C_1'$$

and substitution of the expressions for  $\rho_{\text{ave}}$  and  $A_{\text{ave}}$ , Equations (4.10b) and (4.11b) leads to

$$N_1 = \frac{c_1' N_A \rho_{\text{ave}}}{A_{\text{ave}}}$$

$$= \frac{N_A C_1' \rho_1 \rho_2}{C_1' \rho_2 A_1 + (100 - C_1') \rho_1 A_2}$$

And, solving for  $C_1'$

$$C_1' = \frac{100 N_1 \rho_1 A_2}{N_A \rho_1 \rho_2 - N_1 \rho_2 A_1 + N_1 \rho_1 A_2}$$

Substitution of this expression for  $C_1'$  into Equation (4.7a)

$$C_1 = \frac{C_1' A_1}{C_1' A_1 + C_2' A_2}$$

$$= \frac{C_1' A_1}{C_1' A_1 + 100(1 - C_1') A_2}$$

yields

$$C_1 = \frac{100}{1 + \frac{N_A \rho_2}{N_1 A_1} - \frac{\rho_2}{\rho_1}}$$

the desired expression.

4.21 This problem asks us to determine the weight percent of Au that must be added to Ag such that the resultant alloy will contain  $5.5 \times 10^{21}$  Au atoms per cubic centimeter. To solve this problem, employment of Equation (4.18) is necessary, using the following values:

$$N_1 = N_{Au} = 5.5 \times 10^{21} \text{ atoms/cm}^3$$

$$\rho_1 = \rho_{Au} = 19.32 \text{ g/cm}^3$$

$$\rho_2 = \rho_{Ag} = 10.49 \text{ g/cm}^3$$

$$A_1 = A_{Au} = 196.97 \text{ g/mol}$$

$$A_2 = A_{Ag} = 107.87 \text{ g/mol}$$

Thus

$$\begin{aligned}
 C_{\text{Au}} &= \frac{100}{1 + \frac{N_{\text{Ag}} \rho_{\text{Ag}}}{N_{\text{Au}} A_{\text{Au}}} - \frac{\rho_{\text{Ag}}}{\rho_{\text{Au}}}} \\
 &= \frac{100}{1 + \frac{(6.023 \times 10^{23} \text{ atoms/mol})(10.49 \text{ g/cm}^3)}{(5.5 \times 10^{21} \text{ atoms/cm}^3)(196.97 \text{ g/mol})} - \left(\frac{10.49 \text{ g/cm}^3}{19.32 \text{ g/cm}^3}\right)} \\
 &= 15.9 \text{ wt\%}
 \end{aligned}$$

4.22 This problem asks us to determine the weight percent of Ge that must be added to Si such that the resultant alloy will contain  $2.43 \times 10^{21}$  Ge atoms per cubic centimeter. To solve this problem, employment of Equation (4.18) is necessary, using the following values:

$$N_1 = N_{\text{Ge}} = 2.43 \times 10^{21} \text{ atoms/cm}^3$$

$$\rho_1 = \rho_{\text{Ge}} = 5.32 \text{ g/cm}^3$$

$$\rho_2 = \rho_{\text{Si}} = 2.33 \text{ g/cm}^3$$

$$A_1 = A_{\text{Ge}} = 72.59 \text{ g/mol}$$

$$A_2 = A_{\text{Si}} = 28.09 \text{ g/mol}$$

Thus

$$\begin{aligned}
 C_{\text{Ge}} &= \frac{100}{1 + \frac{N_{\text{Si}} \rho_{\text{Si}}}{N_{\text{Ge}} A_{\text{Ge}}} - \frac{\rho_{\text{Si}}}{\rho_{\text{Ge}}}} \\
 &= \frac{100}{1 + \frac{(6.023 \times 10^{23} \text{ atoms/mol})(2.33 \text{ g/cm}^3)}{(2.43 \times 10^{21} \text{ atoms/cm}^3)(72.59 \text{ g/mol})} - \left(\frac{2.33 \text{ g/cm}^3}{5.32 \text{ g/cm}^3}\right)} \\
 &= 11.7 \text{ wt\%}
 \end{aligned}$$

4.23 This problem asks that we compute the unit cell edge length for a 95 wt% Pt-5 wt% Cu alloy. First of all, the atomic radii for Cu and Pt (Table 3.1) are 0.1278 and 0.1387 nm, respectively. Also, using

Equation (3.5) it is possible to compute the unit cell volume, and inasmuch as the unit cell is cubic, the unit cell edge length is just the cube root of the volume. However, it is first necessary to calculate the density and atomic weight of this alloy using Equations (4.10a) and (4.11a). For the density

$$\begin{aligned} \rho_{ave} &= \frac{100}{\frac{C_{Cu}}{\rho_{Cu}} + \frac{C_{Pt}}{\rho_{Pt}}} \\ &= \frac{100}{\frac{5 \text{ wt\%}}{8.94 \text{ g/cm}^3} + \frac{95 \text{ wt\%}}{21.45 \text{ g/cm}^3}} \\ &= 20.05 \text{ g/cm}^3 \end{aligned}$$

And for the atomic weight

$$\begin{aligned} A_{ave} &= \frac{100}{\frac{C_{Cu}}{A_{Cu}} + \frac{C_{Pt}}{A_{Pt}}} \\ &= \frac{100}{\frac{5 \text{ wt\%}}{63.55 \text{ g/mole}} + \frac{95 \text{ wt\%}}{195.08 \text{ g/mol}}} \\ &= 176.79 \text{ g/mol} \end{aligned}$$

Now,  $V_C$  is determined from Equation (3.5) as

$$\begin{aligned} V_C &= \frac{nA_{ave}}{\rho_{ave} N_A} \\ &= \frac{(4 \text{ atoms/unitcell})(176.79 \text{ g/mol})}{(20.05 \text{ g/cm}^3)(6.023 \times 10^{23} \text{ atoms/mol})} \\ &= 5.856 \times 10^{-23} \text{ cm}^3/\text{unit cell} \end{aligned}$$

And, finally

$$\begin{aligned}
 a &= (V_C)^{1/3} \\
 &= (5.856 \times 10^{-23} \text{ cm}^3/\text{unit cell})^{1/3} \\
 &= 3.883 \times 10^{-8} \text{ cm} = 0.3883 \text{ nm}
 \end{aligned}$$

4.24 The Burgers vector and dislocation line are perpendicular for edge dislocations, parallel for screw dislocations, and neither perpendicular nor parallel for mixed dislocations.

4.25 (a) The Burgers vector will point in that direction having the highest linear density. From Section 3.11, the linear density for the [110] direction in FCC is  $1/2R$ , the maximum possible; therefore for FCC

$$\mathbf{b} = \frac{a}{2} [110]$$

From Problem 3.46 the linear density for the [111] direction in BCC is also  $1/2R$ , and therefore for BCC

$$\mathbf{b} = \frac{a}{2} [111]$$

For simple cubic, a unit cell of which is shown in Figure 3.19, the atom spheres touch one another along the cube edges (i.e., in [100] directions) and therefore, the atomic packing is greatest in these directions. Therefore, the Burgers vector is

$$\mathbf{b} = \frac{a}{2} [100]$$

(b) For Cu which has an FCC crystal structure,  $R = 0.1278 \text{ nm}$  (Table 3.1) and  $a = 2R\sqrt{2} = 0.3615 \text{ nm}$  [Equation (3.1)]; therefore

$$\begin{aligned}
 \mathbf{b} &= \frac{a}{2} \sqrt{h^2 + k^2 + l^2} \\
 &= \frac{0.3615 \text{ nm}}{2} \sqrt{(1)^2 + (1)^2 + (0)^2} = 0.2556 \text{ nm}
 \end{aligned}$$

For Fe which has a BCC crystal structure,  $R = 0.1241$  nm (Table 3.1) and  $a = \frac{4R}{\sqrt{3}} = 0.2866$

nm [Equation (3.3)]; hence

$$b = \frac{0.2866 \text{ nm}}{2} \sqrt{(1)^2 + (1)^2 + (1)^2} = 0.2482 \text{ nm}$$

- 4.26 (a) The surface energy of a single crystal depends on crystallographic orientation because the atomic packing is different for the various crystallographic planes, and, therefore, the number of unsatisfied bonds will vary from plane to plane.
- (b) The surface energy will be greater for an FCC (100) plane than for a (111) plane because the (111) plane is more densely packed (i.e., has more nearest neighbor atoms in the plane)—see Problem 3.47; as a consequence, more atomic bonds will be satisfied for the (111) plane, giving rise to a lower surface energy.
- 4.27 (a) The surface energy will be greater than the grain boundary energy since some atoms on one side of the boundary will bond to atoms on the other side—i.e., there will be fewer unsatisfied bonds along a grain boundary.
- (b) The small angle grain boundary energy is lower than for a high angle one because more atoms bond across the boundary for the small angle, and, thus, there are fewer unsatisfied bonds.
- 4.28 (a) A twin boundary is an interface such that atoms on one side are located at mirror image positions of those atoms situated on the other boundary side. The region on one side of this boundary is called a twin.
- (b) Mechanical twins are produced as a result of mechanical deformation and generally occur in BCC and HCP metals. Annealing twins form during annealing heat treatments, most often in FCC metals.
- 4.29 (a) The interfacial defect that exists for this stacking sequence is a twin boundary, which occurs at the following position





The stacking sequence on one side of this position is mirrored on the other side.

(b) The interfacial defect that exists within this FCC stacking sequence is a stacking fault, which occurs over the region indicated



For this region, the **BCBC** stacking sequence is HCP.

4.30 (a) This problem calls for a determination of the average grain size of the specimen which microstructure is shown in Figure 4.12b. Seven line segments were drawn across the micrograph, each of which was 60 mm long. The average number of grain boundary intersections for these lines was 8.7. Therefore, the average line length intersected is just

$$\frac{60 \text{ mm}}{8.7} = 6.9 \text{ mm}$$

Hence, the average grain diameter, **d**, is

$$d = \frac{\text{ave. line length intersected}}{\text{magnification}} = \frac{6.9 \text{ mm}}{100} = 6.9 \times 10^{-2} \text{ mm}$$

(b) This portion of the problem calls for us to estimate the ASTM grain size number for this same material. The average grain size number, **n**, is related to the number of grains per square inch, **N**, at a magnification of 100x according to Equation 4.16. Inasmuch as the magnification is 100x, the value of **N** is measured directly from the micrgraph, which is approximately 12 grains. Rearranging Equation 4.16 and solving for **n** leads to

$$\begin{aligned} n &= \frac{\log N}{\log 2} + 1 \\ &= \frac{\log 12}{\log 2} + 1 = 4.6 \end{aligned}$$

4.31 (a) This portion of the problem calls for a determination of the average grain size of the specimen which microstructure is shown in Figure 9.22a. Seven line segments were drawn across the

micrograph, each of which was 60 mm long. The average number of grain boundary intersections for these lines was 6.3. Therefore, the average line length intersected is just

$$\frac{60 \text{ mm}}{6.3} = 9.5 \text{ mm}$$

Hence, the average grain diameter, **d**, is

$$d = \frac{\text{ave. line length intersected}}{\text{magnification}} = \frac{9.5 \text{ mm}}{90} = 0.106 \text{ mm}$$

(b) This portion of the problem calls for us to estimate the ASTM grain size number for this same material. The average grain size number, **n**, is related to the number of grains per square inch, **N**, at a magnification of 100x according to Equation 4.16. However, the magnification of this micrograph is not 100x, but rather 90x. Consequently, it is necessary to use the following equation:

$$N_M \left( \frac{M}{100} \right)^2 = 2^{n-1}$$

where **N<sub>M</sub>** = the number of grains per square inch at magnification **M**, and **n** is the ASTM grain size number. (The above equation makes use of the fact that, while magnification is a length parameter, area is expressed in terms of units of length squared. As a consequence, the number of grains per unit area increases with the square of the increase in magnification.) Solving the above expression for **n** leads to

$$n = \frac{\log N_M + 2 \log \left( \frac{M}{100} \right)}{\log 2} + 1$$

From Figure 9.22a, **N<sub>M</sub>** is measured to be approximately 4, which leads to

$$\begin{aligned} n &= \frac{\log 4 + 2 \log \left( \frac{90}{100} \right)}{\log 2} + 1 \\ &= 2.7 \end{aligned}$$

4.32 (a) This part of problem asks that we compute the number of grains per square inch for an ASTM grain size of 6 at a magnification of 100x. All we need do is solve for the parameter **N** in Equation 4.16, inasmuch as **n** = 6. Thus

$$\begin{aligned} N &= 2^{n-1} \\ &= 2^{6-1} = 32 \text{ grains/in.}^2 \end{aligned}$$

(b) Now it is necessary to compute the value of **N** for no magnification. In order to solve this problem it is necessary to use the following equation:

$$N_M \left( \frac{M}{100} \right)^2 = 2^{n-1}$$

where **N<sub>M</sub>** = the number of grains per square inch at magnification **M**, and **n** is the ASTM grain size number. (The above equation makes use of the fact that, while magnification is a length parameter, area is expressed in terms of units of length squared. As a consequence, the number of grains per unit area increases with the square of the increase in magnification.) Without any magnification, **M** in the above equation is 1, and therefore,

$$N_1 \left( \frac{1}{100} \right)^2 = 2^{6-1} = 32$$

And, solving for **N<sub>1</sub>**, **N<sub>1</sub>** = 320,000 grains/in.<sup>2</sup>.

4.33 This problem asks that we determine the ASTM grain size number if 30 grains per square inch are measured at a magnification of 250. In order to solve this problem we make use of the equation cited in Problem 4.31b—i.e.,

$$N_M \left( \frac{M}{100} \right)^2 = 2^{n-1}$$

where **N<sub>M</sub>** = the number of grains per square inch at magnification **M**, and **n** is the ASTM grain size number. Solving the above equation for **n**, and realizing that **N<sub>M</sub>** = 30, while **M** = 250, we have

$$n = \frac{\log N_M + 2 \log \left( \frac{M}{100} \right)}{\log 2} + 1$$

$$= \frac{\log 30 + 2 \log \left( \frac{250}{100} \right)}{\log 2} + 1 = 2.5$$

4.34 This problem asks that we determine the ASTM grain size number if 25 grains per square inch are measured at a magnification of 75. In order to solve this problem we make use of the equation cited in Problem 4.31b—i.e.,

$$N_M \left( \frac{M}{100} \right)^2 = 2^{n-1}$$

where  $N_M$  = the number of grains per square inch at magnification  $M$ , and  $n$  is the ASTM grain size number. Solving the above equation for  $n$ , and realizing that  $N_M = 25$ , while  $M = 75$ , we have

$$n = \frac{\log N_M + 2 \log \left( \frac{M}{100} \right)}{\log 2} + 1$$

$$= \frac{\log 25 + 2 \log \left( \frac{75}{100} \right)}{\log 2} + 1 = 4.8$$

#### Design Problems

4.D1 This problem calls for us to compute the concentration of lithium (in wt%) that, when added to aluminum, will yield an alloy having a density of 2.55 g/cm<sup>3</sup>. Solution of this problem requires the use of Equation (4.10a), which takes the form

$$\rho_{ave} = \frac{100}{\frac{C_{Li}}{\rho_{Li}} + \frac{100 - C_{Li}}{\rho_{Al}}}$$

inasmuch as  $C_{Li} + C_{Al} = 100$ . According to the table inside the front cover, the respective densities of Li and Al are 0.534 and 2.71 g/cm<sup>3</sup>. Upon solving for  $C_{Li}$  from the above equation

$$C_{\text{Li}} = \frac{100 \rho_{\text{Li}} (\rho_{\text{Al}} - \rho_{\text{ave}})}{\rho_{\text{ave}} (\rho_{\text{Al}} - \rho_{\text{Li}})}$$

$$= \frac{(100)(0.534 \text{ g/cm}^3)(2.71 \text{ g/cm}^3 - 2.55 \text{ g/cm}^3)}{2.55 \text{ g/cm}^3(2.71 \text{ g/cm}^3 - 0.534 \text{ g/cm}^3)}$$

$$= 1.537 \text{ wt\%}$$

4.D2 This problem asks that we determine the concentration (in weight percent) of V that must be added to Fe so as to yield a unit cell edge length of 0.289 nm. To begin, it is necessary to employ Equation (3.5), and solve for the unit cell volume,  $V_{\text{C}}$ , as

$$V_{\text{C}} = \frac{nA_{\text{ave}}}{\rho_{\text{ave}} N_{\text{A}}}$$

where  $A_{\text{ave}}$  and  $\rho_{\text{ave}}$  are the atomic weight and density, respectively, of the Fe-V alloy. Inasmuch as both of these materials have the BCC crystal structure, which has cubic symmetry,  $V_{\text{C}}$  is just the cube of the unit cell length,  $a$ . That is

$$V_{\text{C}} = a^3 = (0.289 \text{ nm})^3$$

$$\left(2.89 \times 10^{-8} \text{ cm}\right)^3 = 2.414 \times 10^{-23} \text{ cm}^3$$

It is now necessary to construct expressions for  $A_{\text{ave}}$  and  $\rho_{\text{ave}}$  in terms of the concentration of vanadium,  $C_{\text{V}}$  using Equations (4.11a) and (4.10a). For  $A_{\text{ave}}$  we have

$$A_{\text{ave}} = \frac{100}{\frac{C_{\text{V}}}{A_{\text{V}}} + \frac{(100 - C_{\text{V}})}{A_{\text{Fe}}}}$$

$$= \frac{100}{\frac{C_{\text{V}}}{50.94 \text{ g/mol}} + \frac{(100 - C_{\text{V}})}{55.85 \text{ g/mol}}}$$

whereas for  $\rho_{\text{ave}}$

$$\rho_{ave} = \frac{100}{\frac{C_V}{\rho_V} + \frac{(100 - C_V)}{\rho_{Fe}}}$$

$$= \frac{100}{\frac{C_V}{6.10 \text{ g/cm}^3} + \frac{(100 - C_V)}{7.87 \text{ g/cm}^3}}$$

Within the BCC unit cell there are 2 equivalent atoms, and thus, the value of  $n$  in Equation (3.5) is 2; hence, this expression may be written in terms of the concentration of V in weight percent as follows:

$$V_C = 2.414 \times 10^{-23} \text{ cm}^3$$

$$= \frac{nA_{ave}}{\rho_{ave} N_A}$$

$$= \frac{(2 \text{ atoms/unit cell}) \left[ \frac{100}{\frac{C_V}{50.94 \text{ g/mol}} + \frac{(100 - C_V)}{55.85 \text{ g/mol}}} \right]}{\left[ \frac{100}{\frac{C_V}{6.10 \text{ g/cm}^3} + \frac{(100 - C_V)}{7.87 \text{ g/cm}^3}} \right]} (6.023 \times 10^{23} \text{ atoms/mol})$$

And solving this expression for  $C_V$  leads to  $C_V = 12.9 \text{ wt}\%$ .

## CHAPTER 5

### DIFFUSION

#### PROBLEM SOLUTIONS

- 5.1 Self-diffusion is atomic migration in pure metals--i.e., when all atoms exchanging positions are of the same type. Interdiffusion is diffusion of atoms of one metal into another metal.
- 5.2 Self-diffusion may be monitored by using radioactive isotopes of the metal being studied. The motion of these isotopic atoms may be monitored by measurement of radioactivity level.
- 5.3 (a) With vacancy diffusion, atomic motion is from one lattice site to an adjacent vacancy. Self-diffusion and the diffusion of substitutional impurities proceed via this mechanism. On the other hand, atomic motion is from interstitial site to adjacent interstitial site for the interstitial diffusion mechanism.
- (b) Interstitial diffusion is normally more rapid than vacancy diffusion because: (1) interstitial atoms, being smaller, are more mobile; and (2) the probability of an empty adjacent interstitial site is greater than for a vacancy adjacent to a host (or substitutional impurity) atom.
- 5.4 Steady-state diffusion is the situation wherein the rate of diffusion into a given system is just equal to the rate of diffusion out, such that there is no net accumulation or depletion of diffusing species--i.e., the diffusion flux is independent of time.
- 5.5 (a) The driving force is that which compels a reaction to occur.
- (b) The driving force for steady-state diffusion is the concentration gradient.
- 5.6 This problem calls for the mass of hydrogen, per hour, that diffuses through a Pd sheet. It first becomes necessary to employ both Equations (5.1a) and (5.3). Combining these expressions and solving for the mass yields

$$M = JAt = -DA \frac{\Delta C}{\Delta x} t$$
$$= - (1.0 \times 10^{-8} \text{ m}^2/\text{s}) (0.2 \text{ m}^2) (3600 \text{ s/h}) \left[ \frac{0.6 - 2.4 \text{ kg/m}^3}{5 \times 10^{-3} \text{ m}} \right]$$

$$= 2.6 \times 10^{-3} \text{ kg/h}$$

5.7 We are asked to determine the position at which the nitrogen concentration is  $2 \text{ kg/m}^3$ . This problem is solved by using Equation (5.3) in the form

$$J = -D \frac{C_A - C_B}{x_A - x_B}$$

If we take  $C_A$  to be the point at which the concentration of nitrogen is  $4 \text{ kg/m}^3$ , then it becomes necessary to solve for  $x_B$ , as

$$x_B = x_A + D \left[ \frac{C_A - C_B}{J} \right]$$

Assume  $x_A$  is zero at the surface, in which case

$$x_B = 0 + \left( 6 \times 10^{-11} \text{ m}^2/\text{s} \right) \left[ \frac{(4 \text{ kg/m}^3 - 2 \text{ kg/m}^3)}{1.2 \times 10^{-7} \text{ kg/m}^2 \cdot \text{s}} \right]$$

$$= 1 \times 10^{-3} \text{ m} = 1 \text{ mm}$$

5.8 This problem calls for computation of the diffusion coefficient for a steady-state diffusion situation. Let us first convert the carbon concentrations from wt% to  $\text{kg C/m}^3$  using Equation (4.9a). For 0.012 wt% C

$$C_C'' = \frac{C_C}{\frac{C_C}{\rho_C} + \frac{C_{Fe}}{\rho_{Fe}}} \times 10^3$$

$$= \frac{0.012}{\frac{0.012}{2.25 \text{ g/cm}^3} + \frac{99.988}{7.87 \text{ g/cm}^3}} \times 10^3$$

$$0.944 \text{ kg C/m}^3$$



Similarly, for 0.0075 wt% C

$$C_C'' = \frac{0.0075}{\frac{0.0075}{2.25 \text{ g/cm}^3} + \frac{99.9925}{7.87 \text{ g/cm}^3}} \times 10^3$$

$$= 0.590 \text{ kg C/m}^3$$

Now, using a form of Equation (5.3)

$$D = -J \left[ \frac{x_A - x_B}{C_A - C_B} \right]$$

$$= - \left( 1.40 \times 10^{-8} \text{ kg/m}^2 \cdot \text{s} \right) \left[ \frac{-10^{-3} \text{ m}}{0.944 \text{ kg/m}^3 - 0.590 \text{ kg/m}^3} \right]$$

$$= 3.95 \times 10^{-11} \text{ m}^2/\text{s}$$

5.9 This problem asks for us to compute the diffusion flux of hydrogen gas through a 1-mm thick plate of iron at 250°C when the pressures on the two sides are 0.15 and 7.5 MPa. Ultimately we will employ Equation (5.3) to solve this problem. However, it first becomes necessary to determine the concentration of hydrogen at each face using Equation (5.11). At the low pressure (or B) side

$$C_{H(B)} = \left( 1.34 \times 10^{-2} \right) \sqrt{0.15 \text{ MPa}} \exp \left[ -\frac{27,200 \text{ J/mol}}{(8.31 \text{ J/mol-K})(250 + 273 \text{ K})} \right]$$

$$9.93 \times 10^{-6} \text{ wt\%}$$

Whereas, for the high pressure (or A) side

$$C_{H(A)} = \left( 1.34 \times 10^{-2} \right) \sqrt{7.5 \text{ MPa}} \exp \left[ -\frac{27,200 \text{ J/mol}}{(8.31 \text{ J/mol-K})(250 + 273 \text{ K})} \right]$$

$$7.02 \times 10^{-5} \text{ wt\%}$$

We now convert concentrations in weight percent to mass of hydrogen per unit volume of solid. At face B there are  $9.93 \times 10^{-6}$  g (or  $9.93 \times 10^{-9}$  kg) of hydrogen in 100 g of Fe, which is virtually pure iron. From the density of iron ( $7.87 \text{ g/cm}^3$ ), the volume iron in 100 g ( $V_B$ ) is just

$$V_B = \frac{100 \text{ g}}{7.87 \text{ g/cm}^3} = 12.7 \text{ cm}^3 = 1.27 \times 10^{-5} \text{ m}^3$$

Therefore, the concentration of hydrogen at the B face in kilograms of H per cubic meter of alloy [ $C''_{H(B)}$ ] is just

$$\begin{aligned} C''_{H(B)} &= \frac{C_{H(B)}}{V_B} \\ &= \frac{9.93 \times 10^{-9} \text{ kg}}{1.27 \times 10^{-5} \text{ m}^3} = 7.82 \times 10^{-4} \text{ kg/m}^3 \end{aligned}$$

At the A face the volume of iron in 100 g ( $V_A$ ) will also be  $1.27 \times 10^{-5} \text{ m}^3$ , and

$$\begin{aligned} C''_{H(A)} &= \frac{C_{H(A)}}{V_A} \\ &= \frac{7.02 \times 10^{-8} \text{ kg}}{1.27 \times 10^{-5} \text{ m}^3} = 5.53 \times 10^{-3} \text{ kg/m}^3 \end{aligned}$$

Thus, the concentration gradient is just the difference between these concentrations of hydrogen divided by the thickness of the iron membrane; that is

$$\begin{aligned} \frac{\Delta C}{\Delta x} &= \frac{C''_{H(B)} - C''_{H(A)}}{x_B - x_A} \\ &= \frac{7.82 \times 10^{-4} \text{ kg/m}^3 - 5.53 \times 10^{-3} \text{ kg/m}^3}{10^{-3} \text{ m}} = -4.75 \text{ kg/m}^4 \end{aligned}$$

At this time it becomes necessary to calculate the value of the diffusion coefficient at  $250^\circ\text{C}$  using Equation (5.8). Thus,

$$\begin{aligned}
 D &= D_o \exp\left(-\frac{Q_o}{RT}\right) \\
 &= \left(1.4 \times 10^{-7} \text{ m}^2/\text{s}\right) \exp\left(-\frac{13,400 \text{ J/mol}}{(8.31 \text{ J/mol-K})(250 + 273 \text{ K})}\right) \\
 &= 6.41 \times 10^{-9} \text{ m}^2/\text{s}
 \end{aligned}$$

And, finally, the diffusion flux is computed using Equation (5.3) by taking the negative product of this diffusion coefficient and the concentration gradient, as

$$\begin{aligned}
 J &= -D \frac{\Delta C}{\Delta x} \\
 &= -\left(6.41 \times 10^{-9} \text{ m}^2/\text{s}\right) \left(-4.75 \text{ kg/m}^4\right) = 3.05 \times 10^{-8} \text{ kg/m}^2 \cdot \text{s}
 \end{aligned}$$

5.10 It can be shown that

$$C_x = \frac{B}{\sqrt{Dt}} \exp\left(-\frac{x^2}{4Dt}\right)$$

is a solution to

$$\frac{\partial C}{\partial t} = D \frac{\partial^2 C}{\partial x^2}$$

simply by taking appropriate derivatives of the  $C_x$  expression. When this is carried out,

$$\frac{\partial C}{\partial t} = D \frac{\partial^2 C}{\partial x^2} = \frac{B}{2D^{1/2}t^{3/2}} \left(\frac{x^2}{2Dt} - 1\right) \exp\left(-\frac{x^2}{4Dt}\right)$$

5.11 We are asked to compute the diffusion time required for a specific nonsteady-state diffusion situation. It is first necessary to use Equation (5.5).

$$\frac{C_x - C_o}{C_s - C_o} = 1 - \operatorname{erf}\left(\frac{x}{2\sqrt{Dt}}\right)$$

wherein,  $C_x = 0.45$ ,  $C_o = 0.20$ ,  $C_s = 1.30$ , and  $x = 2 \text{ mm} = 2 \times 10^{-3} \text{ m}$ . Thus,

$$\frac{C_x - C_o}{C_s - C_o} = \frac{0.45 - 0.20}{1.30 - 0.20} = 0.2273 = 1 - \operatorname{erf}\left(\frac{x}{2\sqrt{Dt}}\right)$$

or

$$\operatorname{erf}\left(\frac{x}{2\sqrt{Dt}}\right) = 1 - 0.2273 = 0.7727$$

By linear interpolation from Table 5.1

$z$	$\operatorname{erf}(z)$
0.85	0.7707
$z$	0.7727
0.90	0.7970

$$\frac{z - 0.850}{0.900 - 0.850} = \frac{0.7727 - 0.7707}{0.7970 - 0.7707}$$

From which

$$z = 0.854 = \frac{x}{2\sqrt{Dt}}$$

Now, from Table 5.2, at  $1000^\circ\text{C}$  (1273 K)

$$D = (2.3 \times 10^{-5} \text{ m}^2/\text{s}) \exp\left[-\frac{148,000 \text{ J/mol}}{(8.31 \text{ J/mol-K})(1273 \text{ K})}\right]$$

$$= 1.93 \times 10^{-11} \text{ m}^2/\text{s}$$

Thus,

$$0.854 = \frac{2 \times 10^{-3} \text{ m}}{(2)\sqrt{(1.93 \times 10^{-11} \text{ m}^2/\text{s})(t)}}$$

Solving for  $t$  yields

$$t = 7.1 \times 10^4 \text{ s} = 19.7 \text{ h}$$

5.12 This problem asks that we determine the position at which the carbon concentration is 0.25 wt% after a 10-h heat treatment at 1325 K when  $C_o = 0.55$  wt% C. From Equation (5.5)

$$\frac{C_x - C_o}{C_s - C_o} = \frac{0.25 - 0.55}{0 - 0.55} = 0.5455 = 1 - \operatorname{erf}\left(\frac{x}{2\sqrt{Dt}}\right)$$

Thus,

$$\operatorname{erf}\left(\frac{x}{2\sqrt{Dt}}\right) = 0.4545$$

Using data in Table 5.1 and linear interpolation

$z$	$\operatorname{erf}(z)$
0.40	0.4284
$z$	0.4545
0.45	0.4755

$$\frac{z - 0.40}{0.45 - 0.40} = \frac{0.4545 - 0.4284}{0.4755 - 0.4284}$$

And,

$$z = 0.4277$$

Which means that

$$\frac{x}{2\sqrt{Dt}} = 0.4277$$

And, finally

$$\begin{aligned} x &= 2(0.4277)\sqrt{Dt} = (0.8554)\sqrt{(4.3 \times 10^{-11} \text{ m}^2/\text{s})(3.6 \times 10^4 \text{ s})} \\ &= 1.06 \times 10^{-3} \text{ m} = 1.06 \text{ mm} \end{aligned}$$

5.13 This problem asks us to compute the nitrogen concentration ( $C_x$ ) at the 1 mm position after a 10 h diffusion time, when diffusion is nonsteady- state. From Equation (5.5)

$$\frac{C_x - C_o}{C_s - C_o} = \frac{C_x - 0}{0.1 - 0} = 1 - \operatorname{erf}\left(\frac{x}{2\sqrt{Dt}}\right)$$

$$= 1 - \operatorname{erf}\left[\frac{10^{-3} \text{ m}}{(2)\sqrt{(2.5 \times 10^{-11} \text{ m}^2/\text{s})(10 \text{ h})(3600 \text{ s/h})}}\right]$$

$$= 1 - \operatorname{erf}(0.527)$$

Using data in Table 5.1 and linear interpolation

$z$	$\operatorname{erf}(z)$
0.500	0.5205
0.527	$y$
0.550	0.5633

$$\frac{0.527 - 0.500}{0.550 - 0.500} = \frac{y - 0.5205}{0.5633 - 0.5205}$$

from which

$$y = \operatorname{erf}(0.527) = 0.5436$$

Thus,

$$\frac{C_x - 0}{0.1 - 0} = 1.0 - 0.5436$$

This expression gives

$$C_x = 0.046 \text{ wt\% N}$$

5.14 (a) The solution to Fick's second law for a diffusion couple composed of two semi-infinite solids of the same material is as follows:

$$C_x = \left( \frac{C_1 + C_2}{2} \right) - \left( \frac{C_1 - C_2}{2} \right) \operatorname{erf} \left( \frac{x}{2\sqrt{Dt}} \right)$$

for the boundary conditions

$$C = C_1 \text{ for } x < 0, \text{ and } t = 0$$

$$C = C_2 \text{ for } x > 0, \text{ and } t = 0$$

(b) For this particular silver-gold diffusion couple for which  $C_1 = 5 \text{ wt\% Au}$  and  $C_2 = 2 \text{ wt\% Au}$ , we are asked to determine the diffusion time at  $750^\circ\text{C}$  that will give a composition of  $2.5 \text{ wt\% Au}$  at the  $50 \mu\text{m}$  position. Thus, the equation in part (a) takes the form

$$2.5 = \left( \frac{5 + 2}{2} \right) - \left( \frac{5 - 2}{2} \right) \operatorname{erf} \left( \frac{50 \times 10^{-6} \text{ m}}{2\sqrt{Dt}} \right)$$

It now becomes necessary to compute the diffusion coefficient at  $750^\circ\text{C}$  ( $1023 \text{ K}$ ) given that  $D_0 = 8.5 \times 10^{-5} \text{ m}^2/\text{s}$  and  $Q_d = 202,100 \text{ J/mol}$ . From Equation (5.8) we have

$$\begin{aligned} D &= D_0 \exp \left( -\frac{Q_d}{RT} \right) \\ &= (8.5 \times 10^{-5} \text{ m}^2/\text{s}) \exp \left[ -\frac{202,100 \text{ J/mol}}{(8.31 \text{ J/mol} \cdot \text{K})(1023 \text{ K})} \right] \\ &= 4.03 \times 10^{-15} \text{ m}^2/\text{s} \end{aligned}$$

Substitution of this value into the above equation leads to

$$2.5 = \left( \frac{5 + 2}{2} \right) - \left( \frac{5 - 2}{2} \right) \operatorname{erf} \left[ \frac{50 \times 10^{-6} \text{ m}}{2\sqrt{(4.03 \times 10^{-15} \text{ m}^2/\text{s})t}} \right]$$

This expression reduces to the following form:

$$0.6667 = \operatorname{erf}\left(\frac{393.8\sqrt{s}}{\sqrt{t}}\right)$$

Using data in Table 5.1 and linear interpolation

$z$	$\operatorname{erf}(z)$
0.650	0.6420
$y$	0.6667
0.700	0.6778

$$\frac{y - 0.650}{0.700 - 0.650} = \frac{0.6667 - 0.6420}{0.6778 - 0.6420}$$

from which

$$y = 0.6844 = \frac{393.8\sqrt{s}}{\sqrt{t}}$$

And, solving for  $t$  gives

$$t = 3.31 \times 10^5 \text{ s} = 92 \text{ h}$$

5.15 This problem calls for an estimate of the time necessary to achieve a carbon concentration of 0.45 wt% at a point 5 mm from the surface. From Equation (5.6b),

$$\frac{x^2}{Dt} = \text{constant}$$

But since the temperature is constant, so also is  $D$  constant, and

$$\frac{x^2}{t} = \text{constant}$$

or

$$\frac{x_1^2}{t_1} = \frac{x_2^2}{t_2}$$

Thus,



$$\frac{(2.5 \text{ mm})^2}{10 \text{ h}} = \frac{(5.0 \text{ mm})^2}{t_2}$$

from which

$$t_2 = 40 \text{ h}$$

5.16 We are asked to compute the diffusion coefficients of C in both  $\alpha$  and  $\gamma$  iron at 900°C. Using the data in Table 5.2,

$$\begin{aligned} D_{\alpha} &= (6.2 \times 10^{-7} \text{ m}^2/\text{s}) \exp\left[-\frac{80,000 \text{ J/mol}}{(8.31 \text{ J/mol}\cdot\text{K})(1173 \text{ K})}\right] \\ &= 1.69 \times 10^{-10} \text{ m}^2/\text{s} \end{aligned}$$

$$\begin{aligned} D_{\gamma} &= (2.3 \times 10^{-5} \text{ m}^2/\text{s}) \exp\left[-\frac{148,000 \text{ J/mol}}{(8.31 \text{ J/mol}\cdot\text{K})(1173 \text{ K})}\right] \\ &= 5.86 \times 10^{-12} \text{ m}^2/\text{s} \end{aligned}$$

The **D** for diffusion of C in BCC  $\alpha$  iron is larger, the reason being that the atomic packing factor is smaller than for FCC  $\gamma$  iron (0.68 versus 0.74); this means that there is slightly more interstitial void space in the BCC Fe, and, therefore, the motion of the interstitial carbon atoms occurs more easily.

5.17 This problem asks us to compute the magnitude of **D** for the diffusion of Zn in Cu at 650°C (923 K). From Table 5.2

$$\begin{aligned} D &= (2.4 \times 10^{-5} \text{ m}^2/\text{s}) \exp\left[-\frac{189,000 \text{ J/mol}}{(8.31 \text{ J/mol}\cdot\text{K})(923 \text{ K})}\right] \\ &= 4.8 \times 10^{-16} \text{ m}^2/\text{s} \end{aligned}$$

5.18 We are asked to calculate the temperature at which the diffusion coefficient for the diffusion of Cu in Ni has a value of  $6.5 \times 10^{-17} \text{ m}^2/\text{s}$ . Solving for **T** from Equation (5.9a)

$$T = - \frac{Q_d}{R(\ln D - \ln D_o)}$$

and using the data from Table 5.2 for the diffusion of Cu in Ni

$$T = - \frac{256,000 \text{ J/mol}}{(8.31 \text{ J/mol-K})[\ln(6.5 \times 10^{-17}) - \ln(2.7 \times 10^{-5})]}$$

$$= 1152 \text{ K} = 879^\circ\text{C}$$

5.19 For this problem we are given  $D_o$  and  $Q_d$  for the diffusion of Cr in Ni, and asked to compute the temperature at which  $D = 1.2 \times 10^{-14} \text{ m}^2/\text{s}$ . Solving for  $T$  from Equation (5.9a) yields

$$T = \frac{Q_d}{R(\ln D_o - \ln D)}$$

$$= \frac{272,000 \text{ J/mol}}{(8.31 \text{ J/mol-K})[\ln(1.1 \times 10^{-4}) - \ln(1.2 \times 10^{-14})]}$$

$$= 1427 \text{ K} = 1154^\circ\text{C}$$

5.20 In this problem we are given  $Q_d$  for the diffusion of Cu in Ag (i.e., 193,000 J/mol) and asked to compute  $D$  at 1200 K given that the value of  $D$  at 1000 K is  $1.0 \times 10^{-14} \text{ m}^2/\text{s}$ . It first becomes necessary to solve for  $D_o$  from Equation (5.8) as

$$D_o = D \exp\left(\frac{Q_d}{RT}\right)$$

$$= (1.0 \times 10^{-14} \text{ m}^2/\text{s}) \exp\left[\frac{193,000 \text{ J/mol}}{(8.31 \text{ J/mol-K})(1000 \text{ K})}\right]$$

$$= 1.22 \times 10^{-4} \text{ m}^2/\text{s}$$

Now, solving for  $D$  at 1200 K gives

$$D = (1.22 \times 10^{-4} \text{ m}^2/\text{s}) \exp\left[-\frac{193,000 \text{ J/mol}}{(8.31 \text{ J/mol} \cdot \text{K})(1200 \text{ K})}\right]$$

$$= 4.8 \times 10^{-13} \text{ m}^2/\text{s}$$

5.21 (a) Using Equation (5.9a), we set up two simultaneous equations with  $Q_d$  and  $D_o$  as unknowns. Solving for  $Q_d$  in terms of temperatures  $T_1$  and  $T_2$  (1273 K and 1473 K) and  $D_1$  and  $D_2$  ( $9.4 \times 10^{-16}$  and  $2.4 \times 10^{-14} \text{ m}^2/\text{s}$ ), we get

$$Q_d = -R \frac{\ln D_1 - \ln D_2}{\frac{1}{T_1} - \frac{1}{T_2}}$$

$$= -\frac{(8.31 \text{ J/mol} \cdot \text{K}) \left[ \ln (9.4 \times 10^{-16}) - \ln (2.4 \times 10^{-14}) \right]}{\frac{1}{1273 \text{ K}} - \frac{1}{1473 \text{ K}}}$$

$$= 252,400 \text{ J/mol}$$

Now, solving for  $D_o$  from Equation (5.8)

$$D_o = D_1 \exp\left(\frac{Q_d}{RT_1}\right)$$

$$= (9.4 \times 10^{-16} \text{ m}^2/\text{s}) \exp\left[\frac{252,400 \text{ J/mol}}{(8.31 \text{ J/mol} \cdot \text{K})(1273 \text{ K})}\right]$$

$$= 2.2 \times 10^{-5} \text{ m}^2/\text{s}$$

(b) Using these values of  $D_o$  and  $Q_d$ ,  $D$  at 1373 K is just

$$D = (2.2 \times 10^{-5} \text{ m}^2/\text{s}) \exp\left[-\frac{252,400 \text{ J/mol}}{(8.31 \text{ J/mol} \cdot \text{K})(1373 \text{ K})}\right]$$

$$= 5.4 \times 10^{-15} \text{ m}^2/\text{s}$$

5.22 (a) Using Equation (5.9a), we set up two simultaneous equations with  $Q_d$  and  $D_o$  as unknowns. Solving for  $Q_d$  in terms of temperatures  $T_1$  and  $T_2$  (873 K [600°C] and 973 K [700°C]) and  $D_1$  and  $D_2$  ( $5.5 \times 10^{-14}$  and  $3.9 \times 10^{-13}$  m<sup>2</sup>/s), we get

$$Q_d = -R \frac{\ln D_1 - \ln D_2}{\frac{1}{T_1} - \frac{1}{T_2}}$$

$$= - \frac{(8.31 \text{ J/mol-K}) [\ln (5.5 \times 10^{-14}) - \ln (3.9 \times 10^{-13})]}{\frac{1}{873 \text{ K}} - \frac{1}{973 \text{ K}}}$$

$$= 138,300 \text{ J/mol}$$

Now, solving for  $D_o$  from Equation (5.8)

$$D_o = D_1 \exp\left(\frac{Q_d}{RT_1}\right)$$

$$= (5.5 \times 10^{-14} \text{ m}^2/\text{s}) \exp\left[\frac{138,300 \text{ J/mol}}{(8.31 \text{ J/mol-K})(873 \text{ K})}\right]$$

$$= 1.05 \times 10^{-5} \text{ m}^2/\text{s}$$

(b) Using these values of  $D_o$  and  $Q_d$ ,  $D$  at 1123 K (850°C) is just

$$D = (1.05 \times 10^{-5} \text{ m}^2/\text{s}) \exp\left[-\frac{138,300 \text{ J/mol}}{(8.31 \text{ J/mol-K})(1123 \text{ K})}\right]$$

$$= 3.8 \times 10^{-12} \text{ m}^2/\text{s}$$

5.23 This problem asks us to determine the values of  $Q_d$  and  $D_o$  for the diffusion of Au in Ag from the plot of  $\log D$  versus  $1/T$ . According to Equation (5.9b) the slope of this plot is equal to  $-Q_d/2.3R$  (rather than  $-Q_d/R$  since we are using  $\log D$  rather than  $\ln D$ ) and the intercept at  $1/T = 0$  gives the value of  $\log D_o$ . The slope is equal to

$$\text{slope} = \frac{\Delta(\log D)}{\Delta\left(\frac{1}{T}\right)} = \frac{\log D_1 - \log D_2}{\frac{1}{T_1} - \frac{1}{T_2}}$$

Taking  $1/T_1$  and  $1/T_2$  as  $1.0 \times 10^{-3}$  and  $0.90 \times 10^{-3} \text{ K}^{-1}$ , respectively, then the values of  $\log D_1$  and  $\log D_2$  are  $-14.68$  and  $-13.57$ , respectively. Therefore,

$$\begin{aligned} Q_d &= -2.3 R \frac{\Delta(\log D)}{\Delta\left(\frac{1}{T}\right)} \\ &= -(2.3)(8.31 \text{ J/mol}\cdot\text{K}) \left[ \frac{-14.68 - (-13.57)}{(1.0 \times 10^{-3} - 0.90 \times 10^{-3})\text{K}^{-1}} \right] \\ &= 212,200 \text{ J/mol} \end{aligned}$$

Rather than trying to make a graphical extrapolation to determine  $D_o$ , a more accurate value is obtained analytically using Equation (5.9b) taking a specific value of both  $D$  and  $T$  (from  $1/T$ ) from the plot given in the problem; for example,  $D = 1.0 \times 10^{-14} \text{ m}^2/\text{s}$  at  $T = 1064 \text{ K}$  ( $1/T = 0.94 \times 10^{-3}$ ). Therefore

$$\begin{aligned} D_o &= D \exp\left(\frac{Q_d}{RT}\right) \\ &= (1.0 \times 10^{-14} \text{ m}^2/\text{s}) \exp\left[\frac{212,200 \text{ J/mol}}{(8.31 \text{ J/mol}\cdot\text{K})(1064 \text{ K})}\right] \\ &= 2.65 \times 10^{-4} \text{ m}^2/\text{s} \end{aligned}$$

5.24 This problem asks that we compute the temperature at which the diffusion flux is  $6.3 \times 10^{-10} \text{ kg/m}^2\cdot\text{s}$ . Combining Equations (5.3) and (5.8) yields

$$J = -D_o \frac{\Delta C}{\Delta x} \exp\left(-\frac{Q_d}{RT}\right)$$

Solving for  $T$  from this expression leads to

$$\begin{aligned}
T &= \left( \frac{Q_d}{R} \right) \frac{1}{\ln \left( -\frac{D_o \Delta C}{J \Delta x} \right)} \\
&= \left( \frac{80,000 \text{ J/mol}}{8.31 \text{ J/mol-K}} \right) \frac{1}{\ln \left[ \frac{(6.2 \times 10^{-7} \text{ m}^2/\text{s})(0.45 \text{ kg/m}^3)}{(6.3 \times 10^{-10} \text{ kg/m}^2 \cdot \text{s})(10^{-2} \text{ m})} \right]} \\
&= 900 \text{ K} = 627^\circ\text{C}
\end{aligned}$$

5.25 In order to solve this problem, we must first compute the value of  $D_o$  from the data given at 1200°C (1473 K); this requires the combining of both Equations (5.3) and (5.8). Solving for  $D_o$  from these expressions gives

$$\begin{aligned}
D_o &= -\frac{J}{\Delta C / \Delta x} \exp \left( \frac{Q_d}{RT} \right) \\
&= -\left( \frac{7.8 \times 10^{-8} \text{ kg/m}^2 \cdot \text{s}}{-500 \text{ kg/m}^4} \right) \exp \left[ \frac{145,000 \text{ J/mol}}{(8.31 \text{ J/mol-K})(1473 \text{ K})} \right] \\
&= 2.18 \times 10^{-5} \text{ m}^2/\text{s}
\end{aligned}$$

The value of the diffusion flux at 1273 K may be computed using these same two equations as follows:

$$\begin{aligned}
J &= -D_o \left( \frac{\Delta C}{\Delta x} \right) \exp \left( -\frac{Q_d}{RT} \right) \\
&= -\left( 2.18 \times 10^{-5} \text{ m}^2/\text{s} \right) \left( 500 \text{ kg/m}^4 \right) \exp \left[ -\frac{145,000 \text{ J/mol}}{(8.31 \text{ J/mol-K})(1273 \text{ K})} \right] \\
&= 1.21 \times 10^{-8} \text{ kg/m}^2 \cdot \text{s}
\end{aligned}$$

5.26 To solve this problem it is necessary to employ Equation (5.7) which takes on the form

$$D_{900} t_{900} = D_T t_T$$

At 900°C, and using the data from Table 5.2

$$D_{900} = (2.3 \times 10^{-5} \text{ m}^2/\text{s}) \exp \left[ -\frac{148,000 \text{ J/mol}}{(8.31 \text{ J/mol-K})(900 + 273 \text{ K})} \right]$$

$$= 5.9 \times 10^{-12} \text{ m}^2/\text{s}$$

Thus,

$$(5.9 \times 10^{-12} \text{ m}^2/\text{s})(15 \text{ h}) = D_T(2 \text{ h})$$

And

$$D_T = 4.43 \times 10^{-11} \text{ m}^2/\text{s}$$

Solving for T from Equation (5.9a)

$$T = -\frac{Q_d}{R(\ln D_T - \ln D_o)}$$

$$= -\frac{148,000 \text{ J/mol}}{(8.31 \text{ J/mol-K})[\ln(4.43 \times 10^{-11}) - \ln(2.3 \times 10^{-5})]}$$

$$= 1353 \text{ K} = 1080^\circ\text{C}$$

5.27 (a) We are asked to calculate the diffusion coefficient for Cu in Al at 500°C. Using the data in Table 5.2

$$D = D_o \exp \left( -\frac{Q_d}{RT} \right)$$

$$= (6.5 \times 10^{-5} \text{ m}^2/\text{s}) \exp \left[ -\frac{136,000 \text{ J/mol}}{(8.31 \text{ J/mol-K})(500 + 273 \text{ K})} \right]$$

$$= 4.15 \times 10^{-14} \text{ m}^2/\text{s}$$

(b) This portion of the problem calls for the time required at 600°C to produce the same diffusion result as for 10 h at 500°C. Equation (5.7) is employed as

$$D_{500}t_{500} = D_{600}t_{600}$$

Now, from Equation (5.8)

$$\begin{aligned} D_{600} &= (6.5 \times 10^{-5} \text{ m}^2/\text{s}) \exp \left[ -\frac{136,000 \text{ J/mol}}{(8.31 \text{ J/mol} \cdot \text{K})(600 + 273 \text{ K})} \right] \\ &= 4.69 \times 10^{-13} \text{ m}^2/\text{s} \end{aligned}$$

Thus,

$$\begin{aligned} t_{600} &= \frac{D_{500}t_{500}}{D_{600}} \\ &= \frac{(4.15 \times 10^{-14} \text{ m}^2/\text{s})(10 \text{ h})}{(4.69 \times 10^{-13} \text{ m}^2/\text{s})} = 0.88 \text{ h} \end{aligned}$$

5.28 In order to determine the temperature to which the diffusion couple must be heated so as to produce a concentration of 3.0 wt% Ni at the 2-mm position, we must first utilize Equation (5.6b) with time  $t$  being a constant. That is

$$\frac{x^2}{D} = \text{constant}$$

Or

$$\frac{x_{1000}^2}{D_{1000}} = \frac{x_T^2}{D_T}$$

Now, solving for  $D_T$  utilizing Equation (5.8) in order to compute  $D_{1000}$  yields

$$D_T = \frac{(x_T^2) \left[ D_o \exp \left( -\frac{Q_d}{RT} \right) \right]}{x_{1000}^2}$$



$$= \frac{(2 \text{ mm})^2 \left[ (2.7 \times 10^{-4} \text{ m}^2/\text{s}) \exp \left( -\frac{236,000 \text{ J/mol}}{(8.31 \text{ J/mol-K})(1273 \text{ K})} \right) \right]}{(1 \text{ mm})^2}$$

$$= 2.21 \times 10^{-13} \text{ m}^2/\text{s}$$

We now need to find the **T** at which **D** has this value. This is accomplished by rearranging Equation (5.9a) and solving for **T** as

$$T = \frac{Q_d}{R (\ln D_o - \ln D)}$$

$$= \frac{236,000 \text{ J/mol}}{(8.31 \text{ J/mol-K}) \left[ \ln (2.7 \times 10^{-4}) - \ln (2.21 \times 10^{-13}) \right]}$$

$$= 1357 \text{ K} = 1084^\circ\text{C}$$

5.29 In order to determine the position within the diffusion couple at which the concentration of A in B is 2.5 wt%, we must employ Equation (5.6b) with **t** constant. That is

$$\frac{x^2}{D} = \text{constant}$$

Or

$$\frac{x_{800}^2}{D_{800}} = \frac{x_{1000}^2}{D_{1000}}$$

It is necessary to compute both **D<sub>800</sub>** and **D<sub>1000</sub>** using Equation (5.8), as follows:

$$D_{800} = (1.5 \times 10^{-4} \text{ m}^2/\text{s}) \exp \left[ -\frac{125,000 \text{ J/mol}}{(8.31 \text{ J/mol-K})(1073 \text{ K})} \right]$$

$$= 1.22 \times 10^{-10} \text{ m}^2/\text{s}$$

$$D_{1000} = (1.5 \times 10^{-4} \text{ m}^2/\text{s}) \exp \left[ -\frac{125,000 \text{ J/mol}}{(8.31 \text{ J/mol-K})(1273 \text{ K})} \right]$$

$$= 1.11 \times 10^{-9} \text{ m}^2/\text{s}$$

Now, solving for  $x_{1000}$  yields

$$\begin{aligned}
 x_{1000} &= x_{800} \sqrt{\frac{D_{1000}}{D_{800}}} \\
 &= (5 \text{ mm}) \sqrt{\frac{1.11 \times 10^{-9} \text{ m}^2/\text{s}}{1.22 \times 10^{-10} \text{ m}^2/\text{s}}} \\
 &= 15.1 \text{ mm}
 \end{aligned}$$

5.30 In order to compute the diffusion time at 900°C to produce a carbon concentration of 0.75 wt% at a position 0.5 mm below the surface we must employ Equation (5.6b) with position constant; that is

$$Dt = \text{constant}$$

Or

$$D_{600}t_{600} = D_{900}t_{900}$$

In addition, it is necessary to compute both  $D_{600}$  and  $D_{900}$  using Equation (5.8). From Table 5.2, for the diffusion of C in  $\alpha$  Fe,  $Q_d = 80,000 \text{ J/mol}$  and  $D_0 = 6.2 \times 10^{-7} \text{ m}^2/\text{s}$ . Therefore,

$$\begin{aligned}
 D_{600} &= \left(6.2 \times 10^{-7} \text{ m}^2/\text{s}\right) \exp\left[-\frac{80,000 \text{ J/mol}}{(8.31 \text{ J/mol-K})(600 + 273 \text{ K})}\right] \\
 &= 1.01 \times 10^{-11} \text{ m}^2/\text{s}
 \end{aligned}$$

$$\begin{aligned}
 D_{900} &= \left(6.2 \times 10^{-7} \text{ m}^2/\text{s}\right) \exp\left[-\frac{80,000 \text{ J/mol}}{(8.31 \text{ J/mol-K})(900 + 273 \text{ K})}\right] \\
 &= 1.69 \times 10^{-10} \text{ m}^2/\text{s}
 \end{aligned}$$

Now, solving for  $t_{900}$  gives

$$t_{900} = \frac{D_{600}t_{600}}{D_{900}}$$

$$= \frac{(1.01 \times 10^{-11} \text{ m}^2/\text{s})(100 \text{ min})}{1.69 \times 10^{-10} \text{ m}^2/\text{s}}$$

$$= 5.98 \text{ min}$$

5.31 This problem asks us to compute the temperature at which a nonsteady-state 48 h diffusion anneal was carried out in order to give a carbon concentration of 0.30 wt% C in FCC Fe at a position 3.5 mm below the surface. From Equation (5.5)

$$\frac{C_x - C_o}{C_s - C_o} = \frac{0.30 - 0.10}{1.10 - 0.10} = 0.2000 = 1 - \text{erf}\left(\frac{x}{2\sqrt{Dt}}\right)$$

Or

$$\text{erf}\left(\frac{x}{2\sqrt{Dt}}\right) = 0.8000$$

Now it becomes necessary to, using the data in Table 5.1 and linear interpolation, to determine the value of  $\frac{x}{2\sqrt{Dt}}$ .

$z$	$\text{erf}(z)$
0.90	0.7970
$y$	0.8000
0.95	0.8209

$$\frac{y - 0.90}{0.95 - 0.90} = \frac{0.8000 - 0.7970}{0.8209 - 0.7970}$$

From which

$$y = 0.9063$$

Thus,

$$\frac{x}{2\sqrt{Dt}} = 0.9063$$

And since  $t = 48 \text{ h}$  and  $x = 3.5 \text{ mm}$

$$D = \frac{x^2}{(4t)(0.9063)^2}$$

$$= \frac{(3.5 \times 10^{-3})^2 \text{ m}^2}{(4)(172,800 \text{ s})(0.821)} = 2.16 \times 10^{-11} \text{ m}^2/\text{s}$$

Now, in order to solve for the temperature at which **D** has the above value, we must employ Equation (5.9a); solving for **T** yields

$$T = \frac{Q_d}{R (\ln D_o - \ln D)}$$

From Table 5.2, **D<sub>o</sub>** and **Q<sub>d</sub>** for the diffusion of C in FCC Fe are  $2.3 \times 10^{-5} \text{ m}^2/\text{s}$  and 148,000 J/mol, respectively. Therefore

$$T = \frac{148,000 \text{ J/mol}}{(8.31 \text{ J/mol} \cdot \text{K}) [\ln (2.3 \times 10^{-5}) - \ln (2.16 \times 10^{-11})]}$$

$$= 1283 \text{ K} = 1010^\circ\text{C}$$

### Design Problems

5.D1 This problem calls for us to ascertain whether or not a hydrogen-nitrogen gas mixture may be enriched with respect to hydrogen partial pressure by allowing the gases to diffuse through an iron sheet at an elevated temperature. If this is possible, the temperature and sheet thickness are to be specified; if such is not possible, then we are to state the reasons why. Since this situation involves steady-state diffusion, we employ Fick's first law, Equation (5.3). Inasmuch as the partial pressures on the high-pressure side of the sheet are the same, and the pressure of hydrogen on the low pressure side is five times that of nitrogen, and concentrations are proportional to the square root of the partial pressure, the diffusion flux of hydrogen **J<sub>H</sub>** is the square root of 5 times the diffusion flux of nitrogen **J<sub>N</sub>**--i.e.

$$J_H = \sqrt{5} J_N$$

Thus, equating the Fick's law expressions incorporating the given equations for the diffusion coefficients and concentrations in terms of partial pressures leads to the following

$$\begin{aligned}
 J_H &= \frac{1}{\Delta x} x \\
 (2.5 \times 10^{-3}) (\sqrt{0.1013 \text{ MPa}} - \sqrt{0.051 \text{ MPa}}) \exp\left(-\frac{27.8 \text{ kJ}}{RT}\right) (1.4 \times 10^{-7} \text{ m}^2/\text{s}) \exp\left(-\frac{13.4 \text{ kJ}}{RT}\right) \\
 &= \sqrt{5} J_N \\
 &= \frac{\sqrt{5}}{\Delta x} x \\
 (2.75 \times 10^3) (\sqrt{0.1013 \text{ MPa}} - \sqrt{0.01013 \text{ MPa}}) \exp\left(-\frac{37.6 \text{ kJ}}{RT}\right) (3.0 \times 10^{-7} \text{ m}^2/\text{s}) \exp\left(-\frac{76.15 \text{ kJ}}{RT}\right)
 \end{aligned}$$

The  $\Delta x$ 's cancel out, which means that the process is independent of sheet thickness. Now solving the above expression for the absolute temperature  $T$  gives

$$T = 3467 \text{ K}$$

which value is extremely high (surely above the vaporization point of iron). Thus, such a diffusion process is not possible.

5.D2 This problem calls for us to ascertain whether or not an  $A_2$ - $B_2$  gas mixture may be enriched with respect to the A partial pressure by allowing the gases to diffuse through a metal sheet at an elevated temperature. If this is possible, the temperature and sheet thickness are to be specified; if such is not possible, then we are to state the reasons why. Since this situation involves steady-state diffusion, we employ Fick's first law, Equation (5.3). Inasmuch as the partial pressures on the high-pressure side of the sheet are the same, and the pressure of  $A_2$  on the low pressure side is 2.5 times that of  $B_2$ , and concentrations are proportional to the square root of the partial pressure, the diffusion flux of A,  $J_A$ , is the square root of 2.5 times the diffusion flux of nitrogen  $J_B$ --i.e.

$$J_A = \sqrt{2.5} J_B$$

Thus, equating the Fick's law expressions incorporating the given equations for the diffusion coefficients and concentrations in terms of partial pressures leads to the following

$$\begin{aligned}
 J_A &= \frac{1}{\Delta x} x \\
 (1.5 \times 10^3) (\sqrt{0.1013 \text{ MPa}} - \sqrt{0.051 \text{ MPa}}) \exp\left(-\frac{20.0 \text{ kJ}}{RT}\right) (5.0 \times 10^{-7} \text{ m}^2/\text{s}) \exp\left(-\frac{13.0 \text{ kJ}}{RT}\right) \\
 &= \sqrt{2.5} J_B \\
 &= \frac{\sqrt{2.5}}{\Delta x} x \\
 (2.0 \times 10^3) (\sqrt{0.1013 \text{ MPa}} - \sqrt{0.0203 \text{ MPa}}) \exp\left(-\frac{27.0 \text{ kJ}}{RT}\right) (3.0 \times 10^{-6} \text{ m}^2/\text{s}) \exp\left(-\frac{21.0 \text{ kJ}}{RT}\right)
 \end{aligned}$$

The  $\Delta x$ 's cancel out, which means that the process is independent of sheet thickness. Now solving the above expression for the absolute temperature  $T$  gives

$$T = 568 \text{ K (295}^\circ\text{C)}$$

5.D3 This is a nonsteady-state diffusion situation; thus, it is necessary to employ Equation (5.5), utilizing the following values for the concentration parameters:

$$C_o = 0.0025 \text{ wt\% N}$$

$$C_s = 0.45 \text{ wt\% N}$$

$$C_x = 0.12 \text{ wt\% N}$$

Therefore

$$\begin{aligned}
 \frac{C_x - C_o}{C_s - C_o} &= \frac{0.12 - 0.0025}{0.45 - 0.0025} \\
 &= 0.2626 = 1 - \operatorname{erf}\left(\frac{x}{2\sqrt{Dt}}\right)
 \end{aligned}$$

And thus

$$1 - 0.2626 = 0.7374 = \operatorname{erf}\left(\frac{x}{2\sqrt{Dt}}\right)$$

Using linear interpolation and the data presented in Table 5.1

$z$	$\operatorname{erf}(z)$
0.7500	0.7112
$y$	0.7374
0.8000	0.7421

$$\frac{0.7374 - 0.7112}{0.7421 - 0.7112} = \frac{y - 0.7500}{0.8000 - 0.7500}$$

From which

$$y = \frac{x}{2\sqrt{Dt}} = 0.7924$$

The problem stipulates that  $x = 0.45 \text{ mm} = 4.5 \times 10^{-4} \text{ m}$ . Therefore

$$\frac{4.5 \times 10^{-4} \text{ m}}{2\sqrt{Dt}} = 0.7924$$

Which leads to

$$Dt = 8.06 \times 10^{-8} \text{ m}^2$$

Furthermore, the diffusion coefficient depends on temperature according to Equation (5.8); and, as stipulated in the problem,  $D_o = 3 \times 10^{-7} \text{ m}^2/\text{s}$  and  $Q_d = 76,150 \text{ J/mol}$ . Hence

$$Dt = D_o \exp\left(-\frac{Q_d}{RT}\right)(t) = 8.06 \times 10^{-8} \text{ m}^2$$

$$\left(3.0 \times 10^{-7} \text{ m}^2/\text{s}\right) \exp\left[-\frac{76,150 \text{ J/mol}}{(8.31 \text{ J/mol}\cdot\text{K})(T)}\right](t) = 8.06 \times 10^{-8} \text{ m}^2$$

And solving for the time  $t$

$$t \text{ (in s)} = \frac{0.269}{\exp\left(-\frac{9163.7}{T}\right)}$$

Thus, the required diffusion time may be computed for some specified temperature (in K). Below are tabulated  $t$  values for three different temperatures that lie within the range stipulated in the problem.

Temperature (°C)	Time	
	s	h
500	37,900	10.5
550	18,400	5.1
600	9,700	2.7

5.D4 This is a nonsteady-state diffusion situation; thus, it is necessary to employ Equation (5.5), utilizing the following values for the following parameters:

$$C_o = 0.15 \text{ wt\% C}$$

$$1.2 \text{ wt\% C} \leq C_s \leq 1.4 \text{ wt\% C}$$

$$C_x = 0.75 \text{ wt\% C}$$

$$x = 0.65 \text{ mm}$$

Let us begin by assuming a specific value for the surface concentration within the specified range—say 1.2 wt% C. Therefore

$$\frac{C_x - C_o}{C_s - C_o} = \frac{0.75 - 0.15}{1.20 - 0.15}$$

$$= 0.5714 = 1 - \operatorname{erf}\left(\frac{x}{2\sqrt{Dt}}\right)$$

And thus



$$1 - 0.5714 = 0.4286 = \operatorname{erf}\left(\frac{x}{2\sqrt{Dt}}\right)$$

Using linear interpolation and the data presented in Table 5.1

$z$	$\operatorname{erf}(z)$
0.4000	0.4284
$y$	0.4286
0.4500	0.4755

$$\frac{0.4286 - 0.4284}{0.4755 - 0.4284} = \frac{y - 0.4000}{0.4500 - 0.4000}$$

From which

$$y = \frac{x}{2\sqrt{Dt}} = 0.4002$$

The problem stipulates that  $x = 0.65 \text{ mm} = 6.5 \times 10^{-4} \text{ m}$ . Therefore

$$\frac{6.5 \times 10^{-4} \text{ m}}{2\sqrt{Dt}} = 0.4002$$

Which leads to

$$Dt = 6.59 \times 10^{-7} \text{ m}^2$$

Furthermore, the diffusion coefficient depends on temperature according to Equation (5.8); and, as noted in Design Example 5.1,  $D_o = 2.3 \times 10^{-5} \text{ m}^2/\text{s}$  and  $Q_d = 148,000 \text{ J/mol}$ . Hence

$$Dt = D_o \exp\left(-\frac{Q_d}{RT}\right)(t) = 6.59 \times 10^{-7} \text{ m}^2$$

$$\left(2.3 \times 10^{-5} \text{ m}^2/\text{s}\right) \exp\left[-\frac{148,000 \text{ J/mol}}{(8.31 \text{ J/mol-K})(T)}\right](t) = 6.59 \times 10^{-7} \text{ m}^2$$

And solving for the time  $t$

$$t \text{ (in s)} = \frac{2.86 \times 10^{-2}}{\exp\left(-\frac{17,810}{T}\right)}$$

Thus, the required diffusion time may be computed for some specified temperature (in K). Below are tabulated  $t$  values for three different temperatures that lie within the range stipulated in the problem.

Temperature (°C)	Time	
	s	h
1000	34,100	9.5
1100	12,300	3.4
1200	5,100	1.4

Now, let us repeat the above procedure for two other values of the surface concentration, say 1.3 wt% C and 1.4 wt% C. Below is a tabulation of the results, again using temperatures of 1000°C, 1100°C, and 1200°C.

$C_s$ (wt% C)	Temperature (°C)	Time	
		s	h
1.3	1000	26,700	7.4
	1100	9,600	2.7
	1200	4,000	1.1
1.4	1000	21,100	6.1
	1100	7,900	2.2
	1200	1,500	0.9

CHAPTER 6

MECHANICAL PROPERTIES OF METALS

PROBLEM SOLUTIONS

6.1 This problem asks that we derive Equations (6.4a) and (6.4b), using mechanics of materials principles. In Figure (a) below is shown a block element of material of cross-sectional area  $A$  that is subjected to a tensile force  $P$ . Also represented is a plane that is oriented at an angle  $\theta$  referenced to the plane perpendicular to the tensile axis; the area of this plane is  $A' = A/\cos \theta$ . In addition, the forces normal and parallel to this plane are labeled as  $P'$  and  $V'$ , respectively. Furthermore, on the left-hand side of this block element are shown force components that are tangential and perpendicular to the inclined plane. In Figure (b) are shown the orientations of the applied stress  $\sigma$ , the normal stress to this plane  $\sigma'$ , as well as the shear stress  $\tau'$  taken parallel to this inclined plane. In addition, two coordinate axis systems are represented in Figure (c): the primed  $x$  and  $y$  axes are referenced to the inclined plane, whereas the unprimed  $x$  axis is taken parallel to the applied stress.

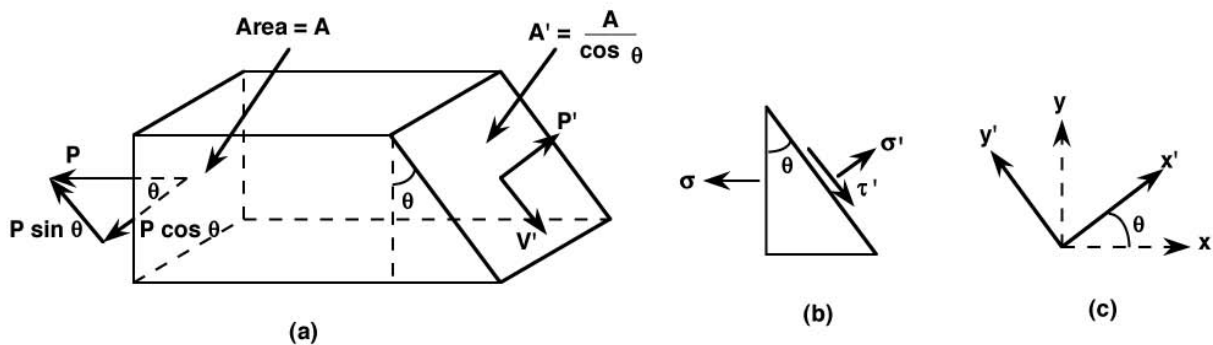

Normal and shear stresses are defined by Equations (6.1) and (6.3), respectively. However, we now chose to express these stresses in terms (i.e., general terms) of normal and shear forces ( $P$  and  $V$ ) as

$$\sigma = \frac{P}{A}$$

$$\tau = \frac{V}{A}$$

For static equilibrium in the  $x'$  direction the following condition must be met:

$$\sum F_{x'} = 0$$

which means that

$$P' - P \cos \theta = 0$$

Or that

$$P' = P \cos \theta$$

Now it is possible to write an expression for the stress  $\sigma'$  in terms of  $P'$  and  $A'$  using the above expression and the relationship between  $A$  and  $A'$  [Figure (a)]:

$$\begin{aligned}\sigma' &= \frac{P'}{A'} \\ &= \frac{P \cos \theta}{\frac{A}{\cos \theta}} = \frac{P}{A} \cos^2 \theta\end{aligned}$$

However, it is the case that  $P/A = \sigma$ ; and, after make this substitution into the above expression, we have Equation (6.4a)--that is

$$\sigma' = \sigma \cos^2 \theta$$

Now, for static equilibrium in the  $y'$  direction, it is necessary that

$$\begin{aligned}\sum F_{y'} &= 0 \\ &= -V' + P \sin \theta\end{aligned}$$

Or

$$V' = P \sin \theta$$

We now write an expression for  $\tau'$  as

$$\tau' = \frac{V'}{A'}$$

And, substitution of the above equation for  $V'$  and also the expression for  $A'$  gives

$$\begin{aligned} \tau' &= \frac{V'}{A'} \\ &= \frac{P \sin \theta}{\frac{A}{\cos \theta}} \\ &= \frac{P}{A} \sin \theta \cos \theta \\ &= \sigma \sin \theta \cos \theta \end{aligned}$$

which is just Equation (6.4b).

6.2 (a) Below are plotted curves of  $\cos^2 \theta$  (for  $\sigma'$ ) and  $\sin \theta \cos \theta$  (for  $\tau'$ ) versus  $\theta$ .

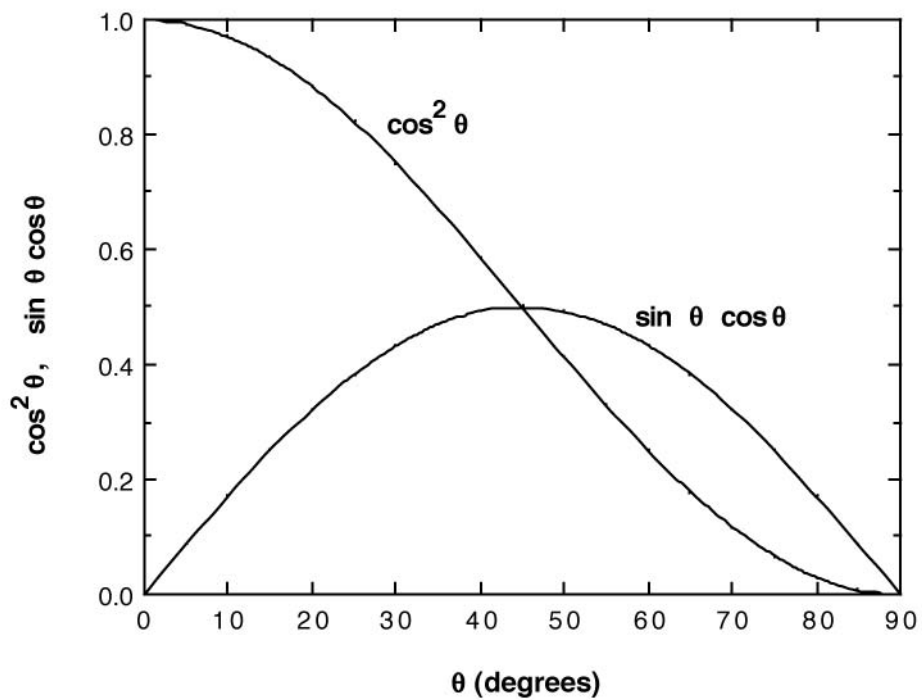

(b) The maximum normal stress occurs at an inclination angle of  $0^\circ$ .

(c) The maximum shear stress occurs at an inclination angle of 45°.

6.3 This problem calls for us to calculate the elastic strain that results for an aluminum specimen stressed in tension. The cross-sectional area is just (10 mm) x (12.7 mm) = 127 mm<sup>2</sup> (= 1.27 x 10<sup>-4</sup> m<sup>2</sup> = 0.20 in.<sup>2</sup>); also, the elastic modulus for Al is given in Table 6.1 as 69 GPa (or 69 x 10<sup>9</sup> N/m<sup>2</sup>). Combining Equations (6.1) and (6.5) and solving for the strain yields

$$\varepsilon = \frac{\sigma}{E} = \frac{F}{A_o E} = \frac{35,500 \text{ N}}{(1.27 \times 10^{-4} \text{ m}^2)(69 \times 10^9 \text{ N/m}^2)} = 4.1 \times 10^{-3}$$

6.4 We are asked to compute the maximum length of a cylindrical titanium alloy specimen that is deformed elastically in tension. For a cylindrical specimen

$$A_o = \pi \left( \frac{d_o}{2} \right)^2$$

where  $d_o$  is the original diameter. Combining Equations (6.1), (6.2), and (6.5) and solving for  $l_o$  leads to

$$\begin{aligned} l_o &= \frac{E \pi d_o^2 \Delta l}{4F} \\ &= \frac{(107 \times 10^9 \text{ N/m}^2)(\pi)(3.8 \times 10^{-3} \text{ m})^2(0.42 \times 10^{-3} \text{ m})}{(4)(2000 \text{ N})} \\ &= 0.25 \text{ m} = 250 \text{ mm} \text{ (10 in.)} \end{aligned}$$

6.5 This problem asks us to compute the elastic modulus of steel. For a square cross-section,  $A_o = b_o^2$ , where  $b_o$  is the edge length. Combining Equations (6.1), (6.2), and (6.5) and solving for  $E$ , leads to

$$\begin{aligned} E &= \frac{F l_o}{b_o^2 \Delta l} = \frac{(89,000 \text{ N})(100 \times 10^{-3} \text{ m})}{(20 \times 10^{-3} \text{ m})^2(0.10 \times 10^{-3} \text{ m})} \\ &= 223 \times 10^9 \text{ N/m}^2 = 223 \text{ GPa} \text{ (31.3} \times 10^6 \text{ psi)} \end{aligned}$$

6.6 In order to compute the elongation of the Ni wire when the 300 N load is applied we must employ Equations (6.1), (6.2), and (6.5). Solving for  $\Delta l$  and realizing that for Ni,  $E = 207 \text{ GPa}$  ( $30 \times 10^6 \text{ psi}$ ) (Table 6.1),

$$\Delta l = \frac{Fl_o}{EA_o} = \frac{Fl_o}{E\pi\left(\frac{d_o}{2}\right)^2}$$

$$= \frac{(4)(300 \text{ N})(30 \text{ m})}{\pi(207 \times 10^9 \text{ N/m}^2)(2 \times 10^{-3} \text{ m})^2} = 0.0138 \text{ m} = 13.8 \text{ mm} (0.53 \text{ in.})$$

6.7 (a) This portion of the problem calls for a determination of the maximum load that can be applied without plastic deformation ( $F_y$ ). Taking the yield strength to be 345 MPa, and employment of Equation (6.1) leads to

$$F_y = \sigma_y A_o = (345 \times 10^6 \text{ N/m}^2)(130 \times 10^{-6} \text{ m}^2)$$

$$= 44,850 \text{ N} (10,000 \text{ lb}_f)$$

(b) The maximum length to which the sample may be deformed without plastic deformation is determined from Equations (6.2) and (6.5) as

$$l_i = l_o \left(1 + \frac{\sigma}{E}\right)$$

$$= (76 \text{ mm}) \left[1 + \frac{345 \text{ MPa}}{103 \times 10^3 \text{ MPa}}\right] = 76.25 \text{ mm} (3.01 \text{ in.})$$

6.8 This problem asks us to compute the diameter of a cylindrical specimen to allow an elongation of 0.50 mm. Employing Equations (6.1), (6.2), and (6.5), assuming that deformation is entirely elastic

$$\sigma = \frac{F}{A_o} = \frac{F}{\pi\left(\frac{d_o}{4}\right)^2} = E \frac{\Delta l}{l_o}$$

Or

$$d_o = \sqrt{\frac{4I_o F}{\pi E \Delta l}}$$

$$= \sqrt{\frac{(4)(380 \times 10^{-3} \text{ m})(6660 \text{ N})}{(\pi)(110 \times 10^9 \text{ N/m}^2)(0.5 \times 10^{-3} \text{ m})}}$$

$$= 7.65 \times 10^{-3} \text{ m} = 7.65 \text{ mm} \text{ (0.30 in.)}$$

- 6.9 This problem asks that we calculate the elongation  $\Delta l$  of a specimen of steel the stress-strain behavior of which is shown in Figure 6.24. First it becomes necessary to compute the stress when a load of 65,250 N is applied as

$$\sigma = \frac{F}{A_o} = \frac{F}{\pi \left(\frac{d_o}{2}\right)^2} = \frac{65,250 \text{ N}}{\pi \left(\frac{8.5 \times 10^{-3} \text{ m}}{2}\right)^2} = 1150 \text{ MPa} \text{ (170,000 psi)}$$

Referring to Figure 6.24, at this stress level we are in the elastic region on the stress-strain curve, which corresponds to a strain of 0.0054. Now, utilization of Equation (6.2) yields

$$\Delta l = \epsilon l_o = (0.0054)(80 \text{ mm}) = 0.43 \text{ mm} \text{ (0.017 in.)}$$

- 6.10 (a) This portion of the problem asks that the tangent modulus be determined for the gray cast iron, the stress-strain behavior of which is shown in Figure 6.25. The slope (i.e.,  $\Delta\sigma/\Delta\epsilon$ ) of a tangent drawn through this curve at 25 MPa (3625 psi) is about 90 GPa ( $15 \times 10^6$  psi).
- (b) The secant modulus taken from the origin is calculated by taking the slope of a secant drawn from the origin through the stress-strain curve at 35 MPa (5,000 psi). When such a secant is drawn, a modulus of approximately 100 GPa ( $14.5 \times 10^6$  psi) is obtained.
- 6.11 We are asked, using the equation given in the problem, to verify that the modulus of elasticity values along [110] directions given in Table 3.3 for aluminum, copper, and iron are correct. The  $\alpha$ ,  $\beta$ , and  $\gamma$  parameters in the equation correspond, respectively, to the cosines of the angles between the [110] direction and [100], [010] and [001] directions. Since these angles are  $45^\circ$ ,  $45^\circ$ , and  $90^\circ$ , the values of  $\alpha$ ,  $\beta$ , and  $\gamma$  are 0.707, 0.707, and 0, respectively. Thus, the given equation takes the form



$$\frac{1}{E_{\langle 110 \rangle}}$$

$$= \frac{1}{E_{\langle 100 \rangle}} - 3 \left( \frac{1}{E_{\langle 100 \rangle}} - \frac{1}{E_{\langle 111 \rangle}} \right) \left[ (0.707)^2 (0.707)^2 + (0.707)^2 (0)^2 + (0)^2 (0.707)^2 \right]$$

$$= \frac{1}{E_{\langle 100 \rangle}} - (0.75) \left( \frac{1}{E_{\langle 100 \rangle}} - \frac{1}{E_{\langle 111 \rangle}} \right)$$

Utilizing the values of  $E_{\langle 100 \rangle}$  and  $E_{\langle 111 \rangle}$  from Table 3.3 for Al

$$\frac{1}{E_{\langle 110 \rangle}} = \frac{1}{63.7 \text{ GPa}} - (0.75) \left[ \frac{1}{63.7 \text{ GPa}} - \frac{1}{76.1 \text{ GPa}} \right]$$

Thus,  $E_{\langle 110 \rangle} = 72.6 \text{ GPa}$ , which is the value given in the table.

For Cu,

$$\frac{1}{E_{\langle 110 \rangle}} = \frac{1}{66.7 \text{ GPa}} - (0.75) \left[ \frac{1}{66.7 \text{ GPa}} - \frac{1}{191.1 \text{ GPa}} \right]$$

from which  $E_{\langle 110 \rangle} = 130.3 \text{ GPa}$ , which is the value given in the table.

Similarly, for Fe

$$\frac{1}{E_{\langle 110 \rangle}} = \frac{1}{125.0 \text{ GPa}} - (0.75) \left[ \frac{1}{125.0 \text{ GPa}} - \frac{1}{272.7 \text{ GPa}} \right]$$

and  $E_{\langle 110 \rangle} = 210.5 \text{ GPa}$ , which is also the value given in the table.

6.12 This problem asks that we derive an expression for the dependence of the modulus of elasticity,  $E$ , on the parameters  $A$ ,  $B$ , and  $n$  in Equation (6.36). It is first necessary to take  $dE_N/dr$  in order to obtain an expression for the force  $F$ ; this is accomplished as follows:

$$F = \frac{dE_N}{dr} = \frac{d\left(-\frac{A}{r}\right)}{dr} + \frac{d\left(\frac{B}{r^n}\right)}{dr}$$

$$= \frac{A}{r^2} - \frac{nB}{r^{(n+1)}}$$

The second step is to set this  $dE_N/dr$  expression equal to zero and then solve for  $r$  ( $= r_o$ ). This procedure is carried out in Problem 2.13, with the result that

$$r_o = \left(\frac{A}{nB}\right)^{1/(1-n)}$$

Next it becomes necessary to take the derivative of the force ( $dF/dr$ ), which is accomplished as follows:

$$\frac{dF}{dr} = \frac{d\left(\frac{A}{r^2}\right)}{dr} + \frac{d\left(-\frac{nB}{r^{(n+1)}}\right)}{dr}$$

$$= -\frac{2A}{r^3} + \frac{(n)(n+1)B}{r^{(n+2)}}$$

Now, substitution for  $r_o$  into this equation yields

$$\left(\frac{dF}{dr}\right)_{r_o} = -\frac{2A}{\left(\frac{A}{nB}\right)^{3/(1-n)}} + \frac{(n)(n+1)B}{\left(\frac{A}{nB}\right)^{(n+2)/(1-n)}}$$

which is the expression to which the modulus of elasticity is proportional.

- 6.13 This problem asks that we rank the magnitudes of the moduli of elasticity of the three hypothetical metals X, Y, and Z. From Problem 6.12, it was shown for materials in which the bonding energy is dependent on the interatomic distance  $r$  according to Equation (6.36), that the modulus of elasticity  $E$  is proportional to

$$E \propto - \frac{2A}{\left(\frac{A}{nB}\right)^{3/(1-n)}} + \frac{(n)(n+1)B}{\left(\frac{A}{nB}\right)^{(n+2)/(1-n)}}$$

For metal X,  $A = 1.5$ ,  $B = 7 \times 10^{-6}$ , and  $n = 8$ . Therefore,

$$E \propto - \frac{(2)(1.5)}{\left[\frac{1.5}{(8)(7 \times 10^{-6})}\right]^{3/(1-8)}} + \frac{(8)(8+1)(7 \times 10^{-6})}{\left[\frac{1.5}{(8)(7 \times 10^{-6})}\right]^{(8+2)/(1-8)}}$$

$$= 830$$

For metal Y,  $A = 2.0$ ,  $B = 1 \times 10^{-5}$ , and  $n = 9$ . Hence

$$E \propto - \frac{(2)(2.0)}{\left[\frac{2.0}{(9)(1 \times 10^{-5})}\right]^{3/(1-9)}} + \frac{(9)(9+1)(1 \times 10^{-5})}{\left[\frac{2.0}{(9)(1 \times 10^{-5})}\right]^{(9+2)/(1-9)}}$$

$$= 683$$

And, for metal Z,  $A = 3.5$ ,  $B = 4 \times 10^{-6}$ , and  $n = 7$ . Thus

$$E \propto - \frac{(2)(3.5)}{\left[\frac{3.5}{(7)(4 \times 10^{-6})}\right]^{3/(1-7)}} + \frac{(7)(7+1)(4 \times 10^{-6})}{\left[\frac{3.5}{(7)(4 \times 10^{-6})}\right]^{(7+2)/(1-7)}}$$

$$= 7425$$

Therefore, metal Z has the highest modulus of elasticity.

- 6.14 (a) We are asked, in this portion of the problem, to determine the elongation of a cylindrical specimen of aluminum. Using Equations (6.1), (6.2), and (6.5)

$$\frac{F}{\pi \left( \frac{d_o^2}{4} \right)} = E \frac{\Delta l}{l_o}$$

Or

$$\begin{aligned} \Delta l &= \frac{4Fl_o}{\pi d_o^2 E} \\ &= \frac{(4)(48,800 \text{ N})(200 \times 10^{-3} \text{ m})}{(\pi)(19 \times 10^{-3} \text{ m})^2 (69 \times 10^9 \text{ N/m}^2)} = 0.50 \text{ mm (0.02 in.)} \end{aligned}$$

(b) We are now called upon to determine the change in diameter,  $\Delta d$ . Using Equation (6.8)

$$\nu = -\frac{\varepsilon_x}{\varepsilon_z} = -\frac{\Delta d/d_o}{\Delta l/l_o}$$

From Table 6.1, for Al,  $\nu = 0.33$ . Now, solving for  $\Delta d$  yields

$$\begin{aligned} \Delta d &= -\frac{\nu \Delta l d_o}{l_o} = -\frac{(0.33)(0.50 \text{ mm})(19 \text{ mm})}{200 \text{ mm}} \\ &= -1.57 \times 10^{-2} \text{ mm } (-6.2 \times 10^{-4} \text{ in.}) \end{aligned}$$

The diameter will decrease.

6.15 This problem asks that we calculate the force necessary to produce a reduction in diameter of  $3 \times 10^{-3}$  mm for a cylindrical bar of steel. Combining Equations (6.1), (6.5), and (6.8), realizing that

$$A_o = \frac{\pi d_o^2}{4}$$

and

$$\varepsilon_x = \frac{\Delta d}{d_o}$$

Now, solving for  $F$  leads to

$$F = -\frac{d_o \Delta d \pi E}{4\nu}$$

From Table (6.1), for steel,  $\nu = 0.30$  and  $E = 207 \text{ GPa}$ . Thus,

$$F = -\frac{(10 \times 10^{-3} \text{ m})(-3.0 \times 10^{-6} \text{ m})(\pi)(207 \times 10^9 \text{ N/m}^2)}{(4)(0.30)}$$

$$= 16,250 \text{ N (3770 lb}_f\text{)}$$

6.16 This problem asks that we compute Poisson's ratio for the metal alloy. From Equations (6.5) and (6.1)

$$\varepsilon_z = \frac{\sigma}{E} = \frac{F/A_o}{E} = \frac{F}{\pi \left(\frac{d_o}{2}\right)^2 E} = \frac{4F}{\pi d_o^2 E}$$

Since the transverse strain  $\varepsilon_x$  is just

$$\varepsilon_x = \frac{\Delta d}{d_o}$$

and Poisson's ratio is defined by Equation (6.8) then

$$\nu = -\frac{\varepsilon_x}{\varepsilon_z} = -\frac{\Delta d/d_o}{\left(\frac{4F}{\pi d_o^2 E}\right)} = -\frac{d_o \Delta d \pi E}{4F}$$

$$= -\frac{(10 \times 10^{-3} \text{ m})(-7 \times 10^{-6} \text{ m})(\pi)(100 \times 10^9 \text{ N/m}^2)}{(4)(15,000 \text{ N})} = 0.367$$

6.17 This problem asks that we compute the original length of a cylindrical specimen that is stressed in compression. It is first convenient to compute the lateral strain  $\varepsilon_x$  as

$$\varepsilon_x = \frac{\Delta d}{d_o} = \frac{30.04 \text{ mm} - 30.00 \text{ mm}}{30.00 \text{ mm}} = 1.33 \times 10^{-3}$$

In order to determine the longitudinal strain  $\epsilon_z$  we need Poisson's ratio, which may be computed using Equation (6.9); solving for  $\nu$  yields

$$\nu = \frac{E}{2G} - 1 = \frac{65.5 \times 10^3 \text{ MPa}}{(2)(25.4 \times 10^3 \text{ MPa})} - 1 = 0.289$$

Now  $\epsilon_z$  may be computed from Equation (6.8) as

$$\epsilon_z = -\frac{\epsilon_x}{\nu} = -\frac{1.33 \times 10^{-3}}{0.289} = -4.60 \times 10^{-3}$$

Now solving for  $l_o$  using Equation (6.2)

$$\begin{aligned} l_o &= \frac{l_i}{1 + \epsilon_z} \\ &= \frac{105.20 \text{ mm}}{1 - 4.60 \times 10^{-3}} = 105.69 \text{ mm} \end{aligned}$$

6.18 This problem asks that we calculate the modulus of elasticity of a metal that is stressed in tension. Combining Equations (6.5) and (6.1) leads to

$$E = \frac{\sigma}{\epsilon_z} = \frac{F/A_o}{\epsilon_z} = \frac{F}{\epsilon_z \pi \left(\frac{d_o}{2}\right)^2} = \frac{4F}{\epsilon_z \pi d_o^2}$$

From the definition of Poisson's ratio, [Equation (6.8)] and realizing that for the transverse strain,  $\epsilon_x = \frac{\Delta d}{d_o}$

$$\epsilon_z = -\frac{\epsilon_x}{\nu} = -\frac{\Delta d}{d_o \nu}$$

Therefore, substitution of this expression for  $\epsilon_z$  into the above equation yields

$$E = \frac{4F}{\epsilon_z \pi d_o^2} = \frac{4F \nu}{\pi d_o \Delta d}$$

$$= \frac{(4)(1500 \text{ N})(0.35)}{\pi (10 \times 10^{-3} \text{ m})(6.7 \times 10^{-7} \text{ m})} = 10^{11} \text{ Pa} = 100 \text{ GPa} \quad (14.7 \times 10^6 \text{ psi})$$

6.19 We are asked to ascertain whether or not it is possible to compute, for brass, the magnitude of the load necessary to produce an elongation of 7.6 mm (0.30 in.). It is first necessary to compute the strain at yielding from the yield strength and the elastic modulus, and then the strain experienced by the test specimen. Then, if

$$\varepsilon(\text{test}) < \varepsilon(\text{yield})$$

deformation is elastic, and the load may be computed using Equations (6.1) and (6.5). However, if

$$\varepsilon(\text{test}) > \varepsilon(\text{yield})$$

computation of the load is not possible inasmuch as deformation is plastic and we have neither a stress-strain plot nor a mathematical expression relating plastic stress and strain. We compute these two strain values as

$$\varepsilon(\text{test}) = \frac{\Delta l}{l_0} = \frac{7.6 \text{ mm}}{250 \text{ mm}} = 0.03$$

and

$$\varepsilon(\text{yield}) = \frac{\sigma_y}{E} = \frac{275 \text{ MPa}}{103 \times 10^3 \text{ MPa}} = 0.0027$$

Therefore, computation of the load is not possible as already explained.

6.20 (a) This part of the problem asks that we ascertain which of the metals in Table 6.1 experience an elongation of less than 0.080 mm when subjected to a stress of 28 MPa. The maximum strain that may be sustained is just

$$\varepsilon = \frac{\Delta l}{l_0} = \frac{0.080 \text{ mm}}{250 \text{ mm}} = 3.2 \times 10^{-4}$$

Since the stress level is given, using Equation (6.5) it is possible to compute the minimum modulus of elasticity which is required to yield this minimum strain. Hence

$$E = \frac{\sigma}{\varepsilon} = \frac{28 \text{ MPa}}{3.2 \times 10^{-4}} = 87.5 \text{ GPa}$$

Which means that those metals with moduli of elasticity greater than this value are acceptable candidates--namely, brass, Cu, Ni, steel, Ti and W.

(b) This portion of the problem further stipulates that the maximum permissible diameter decrease is  $1.2 \times 10^{-3}$  mm. Thus, the maximum possible lateral strain  $\epsilon_x$  is just

$$\epsilon_x = \frac{\Delta d}{d_o} = \frac{-1.2 \times 10^{-3} \text{ mm}}{12.7 \text{ mm}} = -9.45 \times 10^{-5}$$

Since we now have maximum permissible values for both axial and lateral strains, it is possible to determine the maximum allowable value for Poisson's ratio using Equation (6.8). Thus

$$\nu = -\frac{\epsilon_x}{\epsilon_z} = -\frac{-9.45 \times 10^{-5}}{3.2 \times 10^{-4}} = 0.295$$

Or, the value of Poisson's ratio must be less than 0.295. Of the metals in Table 6.1, only W meets both of these criteria.

6.21 (a) This portion of the problem asks that we compute the elongation of the brass specimen. The first calculation necessary is that of the applied stress using Equation (6.1), as

$$\sigma = \frac{F}{A_o} = \frac{F}{\pi \left(\frac{d_o}{2}\right)^2} = \frac{10,000 \text{ N}}{\pi \left(\frac{10 \times 10^{-3} \text{ m}}{2}\right)^2} = 127 \text{ MPa (17,900 psi)}$$

From the stress-strain plot in Figure 6.12, this stress corresponds to a strain of about  $1.5 \times 10^{-3}$ . From the definition of strain, Equation (6.2)

$$\Delta l = \epsilon l_o = (1.5 \times 10^{-3})(101.6 \text{ mm}) = 0.15 \text{ mm (6.0} \times 10^{-3} \text{ in.)}$$

(b) In order to determine the reduction in diameter  $\Delta d$ , it is necessary to use Equation (6.8) and the definition of lateral strain (i.e.,  $\epsilon_x = \Delta d/d_o$ ) as follows

$$\begin{aligned} \Delta d &= d_o \epsilon_x = -d_o \nu \epsilon_z = -(10 \text{ mm})(0.35)(1.5 \times 10^{-3}) \\ &= -5.25 \times 10^{-3} \text{ mm (-2.05} \times 10^{-4} \text{ in.)} \end{aligned}$$



6.22 Elastic deformation is time-independent and nonpermanent, anelastic deformation is time-dependent and nonpermanent, while plastic deformation is permanent.

6.23 This problem asks that we assess the four alloys relative to the two criteria presented. The first criterion is that the material not experience plastic deformation when the tensile load of 35,000 N is applied; this means that the stress corresponding to this load not exceed the yield strength of the material. Upon computing the stress

$$\sigma = \frac{F}{A_o} = \frac{F}{\pi \left( \frac{d_o}{2} \right)^2} = \frac{35,000 \text{ N}}{\pi \left( \frac{15 \times 10^{-3} \text{ m}}{2} \right)^2} = 200 \times 10^6 \text{ N/m}^2 = 200 \text{ MPa}$$

Of the alloys listed in the table, the Al, Ti and steel alloys have yield strengths greater than 200 MPa.

Relative to the second criterion, it is necessary to calculate the change in diameter  $\Delta d$  for these two alloys. From Equation (6.8)

$$\nu = -\frac{\varepsilon_x}{\varepsilon_z} = -\frac{\Delta d/d_o}{\sigma/E}$$

Now, solving for  $\Delta d$  from this expression,

$$\Delta d = -\frac{\nu \sigma d_o}{E}$$

For the aluminum alloy

$$\Delta d = -\frac{(0.33)(200 \text{ MPa})(15 \text{ mm})}{70 \times 10^3 \text{ MPa}} = -1.41 \times 10^{-3} \text{ mm}$$

Therefore, the Al alloy is not a candidate.

For the steel alloy

$$\Delta d = -\frac{(0.27)(200 \text{ MPa})(15 \text{ mm})}{205 \times 10^3 \text{ MPa}} = -0.40 \times 10^{-2} \text{ mm}$$

Therefore, the steel is a candidate.

For the Ti alloy

$$\Delta d = - \frac{(0.36)(200 \text{ MPa})(15 \text{ mm})}{105 \times 10^3 \text{ MPa}} = -1.0 \times 10^{-2} \text{ mm}$$

Hence, the titanium alloy is also a candidate.

6.24 This problem asks that we ascertain which of four metal alloys will 1) not experience plastic deformation, and 2) not elongate more than 0.9 mm when a tensile load is applied. It is first necessary to compute the stress using Equation (6.1); a material to be used for this application must necessarily have a yield strength greater than this value. Thus,

$$\sigma = \frac{F}{A_o} = \frac{24,500 \text{ N}}{\pi \left( \frac{10 \times 10^{-3} \text{ m}}{2} \right)^2} = 312 \text{ MPa}$$

Of the metal alloys listed, only brass and steel have yield strengths greater than this stress.

Next, we must compute the elongation produced in both brass and steel using Equations (6.2) and (6.5) in order to determine whether or not this elongation is less than 0.9 mm. For brass

$$\Delta l = \frac{\sigma l_o}{E} = \frac{(312 \text{ MPa})(380 \text{ mm})}{100 \times 10^3 \text{ MPa}} = 1.19 \text{ mm}$$

Thus, brass is not a candidate. However, for steel

$$\Delta l = \frac{\sigma l_o}{E} = \frac{(312 \text{ MPa})(380 \text{ mm})}{207 \times 10^3 \text{ MPa}} = 0.57 \text{ mm}$$

Therefore, of these four alloys, only steel satisfies the stipulated criteria.

6.25 Using the stress-strain plot for a steel alloy (Figure 6.24), we are asked to determine several of its mechanical characteristics.

(a) The elastic modulus is just the slope of the initial linear portion of the curve; or, from the inset and using Equation (6.10)

$$E = \frac{\sigma_2 - \sigma_1}{\epsilon_2 - \epsilon_1} = \frac{(1300 - 0) \text{ MPa}}{(6.25 \times 10^{-3} - 0)} = 210 \times 10^3 \text{ MPa} = 210 \text{ GPa} \quad (30.5 \times 10^6 \text{ psi})$$

The value given in Table 6.1 is 207 GPa.

(b) The proportional limit is the stress level at which linearity of the stress-strain curve ends, which is approximately 1370 MPa (200,000 psi).

(c) The 0.002 strain offset line intersects the stress-strain curve at approximately 1570 MPa (228,000 psi).

(d) The tensile strength (the maximum on the curve) is approximately 1970 MPa (285,000 psi).

6.26 We are asked to calculate the radius of a cylindrical brass specimen in order to produce an elongation of 5 mm when a load of 100,000 N is applied. It first becomes necessary to compute the strain corresponding to this elongation using Equation (6.2) as

$$\varepsilon = \frac{\Delta l}{l_0} = \frac{5 \text{ mm}}{100 \text{ mm}} = 5 \times 10^{-2}$$

From Figure 6.12, a stress of 335 MPa (49,000 psi) corresponds to this strain. Since for a cylindrical specimen, stress, force, and initial radius  $r_0$  are related as

$$\sigma = \frac{F}{\pi r_0^2}$$

then

$$r_0 = \sqrt{\frac{F}{\pi \sigma}} = \sqrt{\frac{100,000 \text{ N}}{\pi (335 \times 10^6 \text{ N/m}^2)}} = 0.0097 \text{ m} = 9.7 \text{ mm} \text{ (0.38 in.)}$$

6.27 This problem asks us to determine the deformation characteristics of a steel specimen, the stress-strain behavior of which is shown in Figure 6.24.

(a) In order to ascertain whether the deformation is elastic or plastic, we must first compute the stress, then locate it on the stress-strain curve, and, finally, note whether this point is on the elastic or plastic region. Thus,

$$\sigma = \frac{F}{A_0} = \frac{140,000 \text{ N}}{\pi \left( \frac{10 \times 10^{-3} \text{ m}}{2} \right)^2} = 1782 \text{ MPa} \text{ (250,000 psi)}$$

The 1782 MPa point is past the linear portion of the curve, and, therefore, the deformation will be both elastic and plastic.

(b) This portion of the problem asks us to compute the increase in specimen length. From the stress-strain curve, the strain at 1782 MPa is approximately 0.017. Thus, from Equation (6.2)

$$\Delta l = \varepsilon l_0 = (0.017)(500 \text{ mm}) = 8.5 \text{ mm} \quad (0.34 \text{ in.})$$

6.28 (a) We are asked to compute the magnitude of the load necessary to produce an elongation of 2.25 mm for the steel displaying the stress-strain behavior shown in Figure 6.24. First, calculate the strain, and then the corresponding stress from the plot.

$$\varepsilon = \frac{\Delta l}{l_0} = \frac{2.25 \text{ mm}}{375 \text{ mm}} = 0.006$$

This is within the elastic region; from the inset of Figure 6.24, this corresponds to a stress of about 1250 MPa (180,000 psi). Now,

$$F = \sigma A_0 = \sigma b^2$$

in which **b** is the cross-section side length. Thus,

$$F = (1250 \times 10^6 \text{ N/m}^2) (5.5 \times 10^{-3} \text{ m})^2 = 37,800 \text{ N} \quad (8500 \text{ lb}_f)$$

(b) After the load is released there will be no deformation since the material was strained only elastically.

6.29 This problem calls for us to make a stress-strain plot for aluminum, given its tensile load-length data, and then to determine some of its mechanical characteristics.

(a) The data are plotted below on two plots: the first corresponds to the entire stress-strain curve, while for the second, the curve extends just beyond the elastic region of deformation.

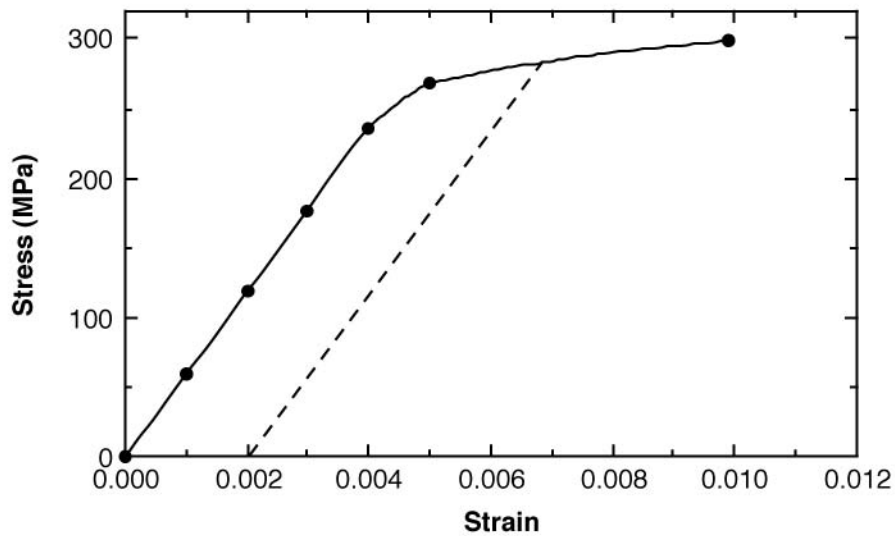
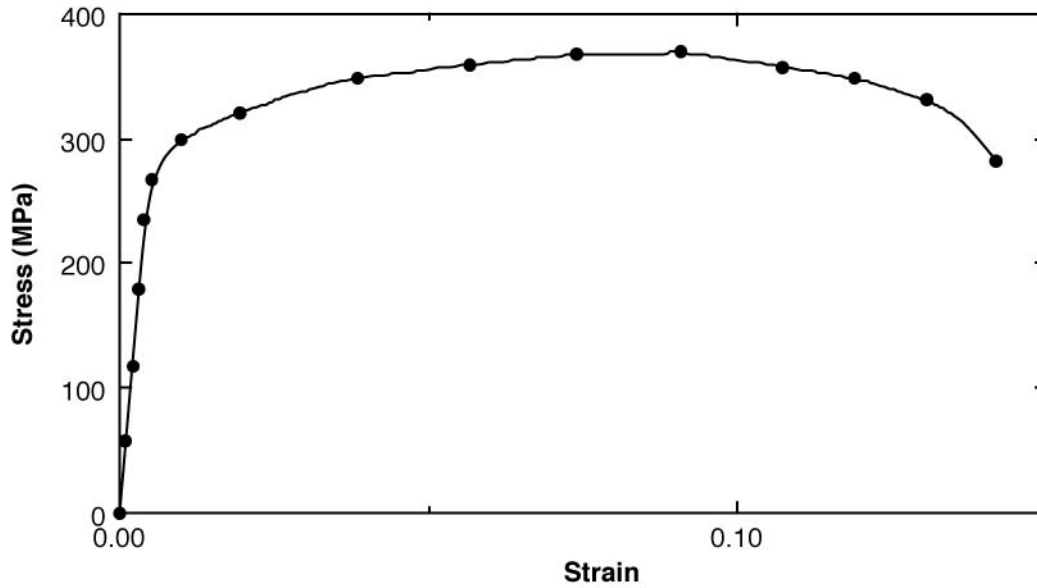

(b) The elastic modulus is the slope in the linear elastic region as

$$E = \frac{\Delta\sigma}{\Delta\varepsilon} = \frac{200 \text{ MPa} - 0 \text{ MPa}}{0.0032 - 0} = 62.5 \times 10^3 \text{ MPa} = 62.5 \text{ GPa} \quad (9.1 \times 10^6 \text{ psi})$$

(c) For the yield strength, the 0.002 strain offset line is drawn dashed. It intersects the stress-strain curve at approximately 285 MPa (41,000 psi).

(d) The tensile strength is approximately 370 MPa (53,500 psi), corresponding to the maximum stress on the complete stress-strain plot.

- (e) The ductility, in percent elongation, is just the plastic strain at fracture, multiplied by one-hundred. The total fracture strain at fracture is 0.165; subtracting out the elastic strain (which is about 0.005) leaves a plastic strain of 0.160. Thus, the ductility is about 16%EL.
- (f) From Equation (6.14), the modulus of resilience is just

$$U_r = \frac{\sigma_y^2}{2E}$$

which, using data computed in the problem, yields a value of

$$U_r = \frac{(285 \text{ MPa})^2}{(2)(62.5 \times 10^3 \text{ MPa})} = 6.5 \times 10^5 \text{ J/m}^3 \quad (93.8 \text{ in.} \cdot \text{lb}_f/\text{in.}^3)$$

6.30 This problem calls for us to make a stress-strain plot for a magnesium, given its tensile load-length data, and then to determine some of its mechanical characteristics.

- (a) The data are plotted below on two plots: the first corresponds to the entire stress-strain curve, while for the second, the curve extends just beyond the elastic region of deformation.

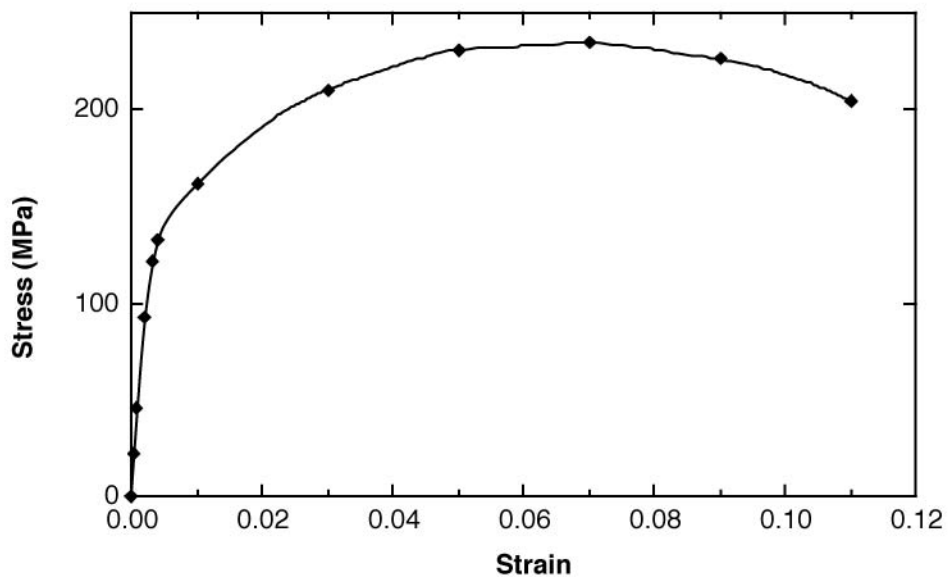

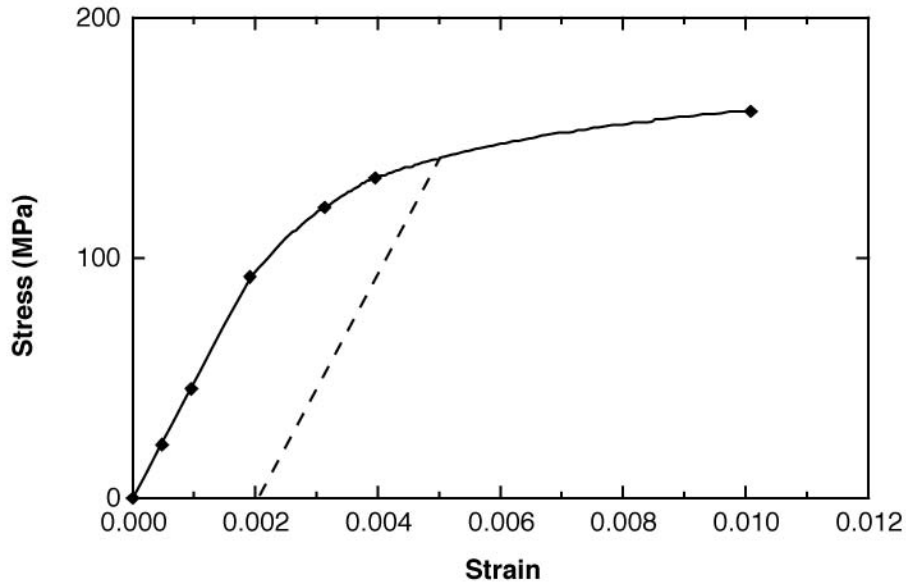

(b) The elastic modulus is the slope in the linear elastic region as

$$E = \frac{\Delta \sigma}{\Delta \epsilon} = \frac{50 \text{ MPa} - 0 \text{ MPa}}{0.001 - 0} = 50 \times 10^3 \text{ MPa} = 50 \text{ GPa} \quad (7.3 \times 10^6 \text{ psi})$$

(c) For the yield strength, the 0.002 strain offset line is drawn dashed. It intersects the stress-strain curve at approximately 150 MPa (21,750 psi).

(d) The tensile strength is approximately 240 MPa (34,800 psi), corresponding to the maximum stress on the complete stress-strain plot.

(e) From Equation (6.14), the modulus of resilience is just

$$U_r = \frac{\sigma_y^2}{2E}$$

which, using data computed in the problem, yields a value of

$$U_r = \frac{(150 \times 10^6 \text{ N/m}^2)^2}{(2)(50 \times 10^9 \text{ N/m}^2)} = 2.25 \times 10^5 \text{ J/m}^3 \quad (32.6 \text{ in.} \cdot \text{lb}_f/\text{in.}^3)$$

(f) The ductility, in percent elongation, is just the plastic strain at fracture, multiplied by one-hundred. The total fracture strain at fracture is 0.110; subtracting out the elastic strain (which is about 0.003) leaves a plastic strain of 0.107. Thus, the ductility is about 10.7%EL.

6.31 This problem calls for ductility in both percent reduction in area and percent elongation. Percent reduction in area is computed using Equation (6.12) as

$$\%RA = \frac{\pi \left( \frac{d_o}{2} \right)^2 - \pi \left( \frac{d_f}{2} \right)^2}{\pi \left( \frac{d_o}{2} \right)^2} \times 100$$

in which  $d_o$  and  $d_f$  are, respectively, the original and fracture cross-sectional areas. Thus,

$$\%RA = \frac{\pi \left( \frac{12.8 \text{ mm}}{2} \right)^2 - \pi \left( \frac{6.60 \text{ mm}}{2} \right)^2}{\pi \left( \frac{12.8 \text{ mm}}{2} \right)^2} \times 100 = 73.4\%$$

While, for percent elongation, Equation (6.11) is used as

$$\begin{aligned} \%EL &= \left( \frac{l_f - l_o}{l_o} \right) \times 100 \\ &= \frac{72.14 \text{ mm} - 50.80 \text{ mm}}{50.80 \text{ mm}} \times 100 = 42\% \end{aligned}$$

6.32 This problem asks us to calculate the moduli of resilience for the materials having the stress-strain behaviors shown in Figures 6.12 and 6.24. According to Equation (6.14), the modulus of resilience  $U_r$  is a function of the yield strength and the modulus of elasticity as

$$U_r = \frac{\sigma_y^2}{2E}$$

The values for  $\sigma_y$  and  $E$  for the brass in Figure 6.12 are 250 MPa (36,000 psi) and 93.9 GPa ( $13.6 \times 10^6$  psi), respectively. Thus

$$U_r = \frac{(250 \text{ MPa})^2}{(2)(93.9 \times 10^3 \text{ MPa})} = 3.32 \times 10^5 \text{ J/m}^3 \quad (47.6 \text{ in.} \cdot \text{lb}_f/\text{in.}^3)$$



Values of the corresponding parameters for the steel alloy (Figure 6.24) are 1570 MPa (230,000 psi) and 210 GPa ( $30.5 \times 10^6$  psi), respectively, and therefore

$$U_r = \frac{(1570 \text{ MPa})^2}{(2)(210 \times 10^3 \text{ MPa})} = 5.87 \times 10^6 \text{ J/m}^3 \quad (867 \text{ in.} \cdot \text{lb}_f/\text{in.}^3)$$

6.33 The moduli of resilience of the alloys listed in the table may be determined using Equation (6.14). Yield strength values are provided in this table, whereas the elastic moduli are tabulated in Table 6.1.

For steel

$$U_r = \frac{\sigma_y^2}{2E}$$

$$= \frac{(830 \times 10^6 \text{ N/m}^2)^2}{(2)(207 \times 10^9 \text{ N/m}^2)} = 16.6 \times 10^5 \text{ J/m}^3 \quad (240 \text{ in.} \cdot \text{lb}_f/\text{in.}^3)$$

For the brass

$$U_r = \frac{(380 \times 10^6 \text{ N/m}^2)^2}{(2)(97 \times 10^9 \text{ N/m}^2)} = 7.44 \times 10^5 \text{ J/m}^3 \quad (108 \text{ in.} \cdot \text{lb}_f/\text{in.}^3)$$

For the aluminum alloy

$$U_r = \frac{(275 \times 10^6 \text{ N/m}^2)^2}{(2)(69 \times 10^9 \text{ N/m}^2)} = 5.48 \times 10^5 \text{ J/m}^3 \quad (80.0 \text{ in.} \cdot \text{lb}_f/\text{in.}^3)$$

And, for the titanium alloy

$$U_r = \frac{(690 \times 10^6 \text{ N/m}^2)^2}{(2)(107 \times 10^9 \text{ N/m}^2)} = 22.2 \times 10^5 \text{ J/m}^3 \quad (323 \text{ in.} \cdot \text{lb}_f/\text{in.}^3)$$

6.34 The modulus of resilience, yield strength, and elastic modulus of elasticity are related to one another through Equation (6.14); the value of  $E$  for steel given in Table 6.1 is 207 GPa. Solving for  $\sigma_y$  from this expression yields

$$\begin{aligned}\sigma_y &= \sqrt{2U_r E} = \sqrt{(2)(2.07 \text{ MPa})(207 \times 10^3 \text{ MPa})} \\ &= 925 \text{ MPa (134,000 psi)}\end{aligned}$$

6.35 (a) In the schematic plot shown below, curve (1) represents the tensile true stress-strain behavior for a typical metal alloy.

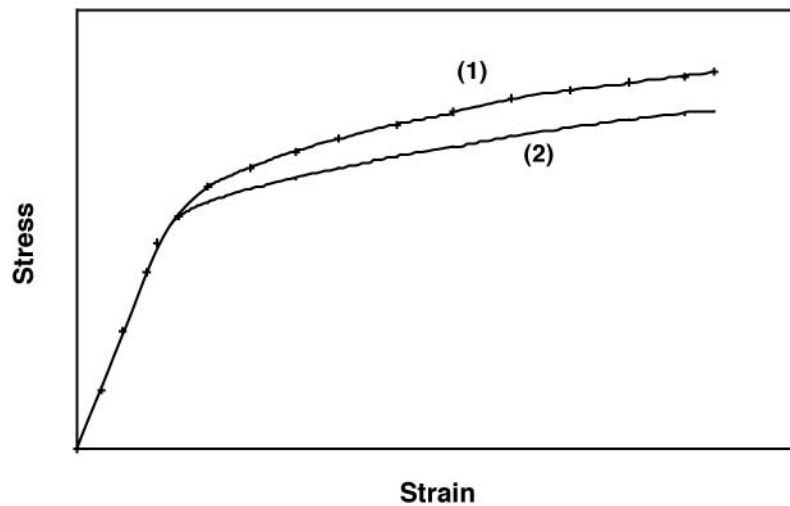

(b) The compressive stress-strain behavior is also represented by curve (1), which is virtually the same as that for the tensile behavior inasmuch as both compressive and tensile true stress take into account the cross-sectional area over which deformation is occurring (i.e., within the neck region for tensile behavior).

(c) Curve (2) in this plot represents the compression engineering stress-strain behavior for this same alloy; this curve lies below curve (1) which is for compression true stress and strain. The reason for this is that during compression the cross-sectional area is increasing (that is,  $A_i > A_o$ ), and since  $\sigma = F/A_o$  and  $\sigma_T = F/A_i$ , then it follows that  $\sigma_T < \sigma$ .

6.36 To show that Equation (6.18a) is valid, we must first rearrange Equation (6.17) as

$$A_i = \frac{A_o l_o}{l_i}$$

Substituting this expression into Equation (6.15) yields

$$\sigma_T = \frac{F}{A_i} = \frac{F}{A_o} \left( \frac{l_i}{l_o} \right) = \sigma \left( \frac{l_i}{l_o} \right)$$

But, from Equation (6.2)

$$\varepsilon = \frac{l_i}{l_o} - 1$$

Or

$$\frac{l_i}{l_o} = \varepsilon + 1$$

Thus,

$$\sigma_T = \sigma \left( \frac{l_i}{l_o} \right) = \sigma(\varepsilon + 1)$$

For Equation (6.18b)

$$\varepsilon_T = \ln(1 + \varepsilon)$$

is valid since

$$\varepsilon_T = \ln \left( \frac{l_i}{l_o} \right)$$

and

$$\frac{l_i}{l_o} = \varepsilon + 1$$

from above.

6.37 This problem asks us to demonstrate that true strain may also be represented by

$$\varepsilon_T = \ln \left( \frac{A_o}{A_i} \right)$$

Rearrangement of Equation (6.17) leads to

$$\frac{l_i}{l_o} = \frac{A_o}{A_i}$$

Thus, Equation (6.16) takes the form

$$\epsilon_T = \ln\left(\frac{l_i}{l_o}\right) = \ln\left(\frac{A_o}{A_i}\right)$$

The expression  $\epsilon_T = \ln\left(\frac{A_o}{A_i}\right)$  is more valid during necking because  $A_i$  is taken as the area of the neck.

6.38 These true stress-strain data are plotted below.

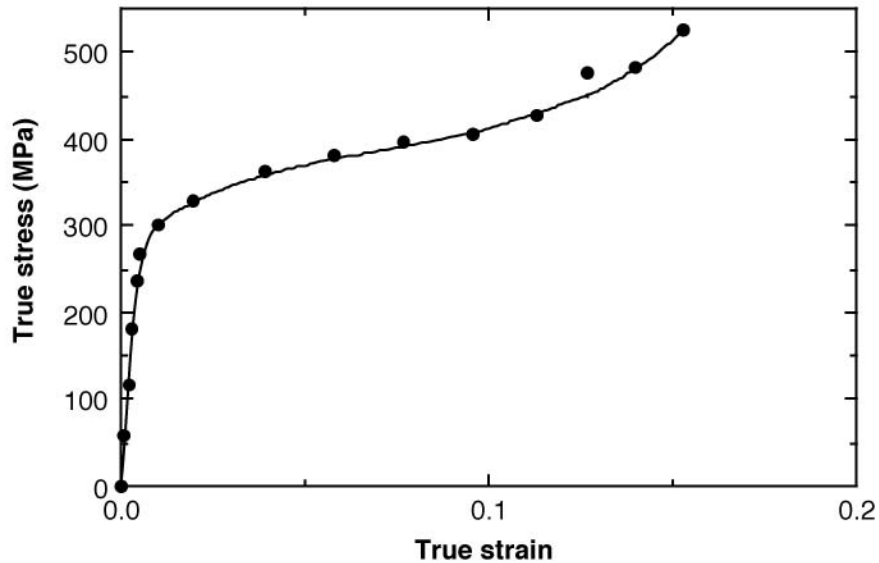

6.39 We are asked to compute the true strain that results from the application of a true stress of 600 MPa (87,000 psi); other true stress-strain data are also given. It first becomes necessary to solve for  $n$  in Equation (6.19). Taking logarithms of this expression and after rearrangement we have

$$n = \frac{\log \sigma_T - \log K}{\log \varepsilon_T}$$

$$= \frac{\log (575 \text{ MPa}) - \log (860 \text{ MPa})}{\log (0.2)} = 0.250$$

Expressing  $\varepsilon_T$  as the dependent variable, and then solving for its value from the data stipulated in the problem, leads to

$$\varepsilon_T = \left( \frac{\sigma_T}{K} \right)^{1/n} = \left( \frac{600 \text{ MPa}}{860 \text{ MPa}} \right)^{1/0.25} = 0.237$$

6.40 We are asked to compute how much elongation a metal specimen will experience when a true stress of 415 MPa is applied, given the value of  $n$  and that a given true stress produces a specific true strain. Solution of this problem requires that we utilize Equation (6.19). It is first necessary to solve for  $K$  from the given true stress and strain. Rearrangement of this equation yields

$$K = \frac{\sigma_T}{(\varepsilon_T)^n} = \frac{345 \text{ MPa}}{(0.02)^{0.22}} = 816 \text{ MPa (118,000 psi)}$$

Next we must solve for the true strain produced when a true stress of 415 MPa is applied, also using Equation (6.19). Thus

$$\varepsilon_T = \left( \frac{\sigma_T}{K} \right)^{1/n} = \left( \frac{415 \text{ MPa}}{816 \text{ MPa}} \right)^{1/0.22} = 0.0463 = \ln \left( \frac{l_i}{l_o} \right)$$

Now, solving for  $l_i$  gives

$$l_i = l_o e^{0.0463} = (500 \text{ mm}) e^{0.0463} = 523.7 \text{ mm (20.948 in.)}$$

And finally, the elongation  $\Delta l$  is just

$$\Delta l = l_i - l_o = 523.7 \text{ mm} - 500 \text{ mm} = 23.7 \text{ mm (0.948 in.)}$$

6.41 For this problem, we are given two values of  $\epsilon_T$  and  $\sigma_T$ , from which we are asked to calculate the true stress which produces a true plastic strain of 0.25. After taking logarithms of Equation (6.19), we may set up two simultaneous equations with two unknowns (the unknowns being  $K$  and  $n$ ), as

$$\log (50,000 \text{ psi}) = \log K + n \log (0.10)$$

$$\log (60,000 \text{ psi}) = \log K + n \log (0.20)$$

From these two expressions,

$$n = \frac{\log (50,000) - \log (60,000)}{\log (0.1) - \log (0.2)} = 0.263$$

$$\log K = 4.96 \text{ or } K = 91,623 \text{ psi}$$

Thus, for  $\epsilon_T = 0.25$

$$\sigma_T = K(\epsilon_T)^{0.263} = (91,623 \text{ psi})(0.25)^{0.263} = 63,700 \text{ psi (440 MPa)}$$

6.42 For this problem we first need to convert engineering stresses and strains to true stresses and strains so that the constants  $K$  and  $n$  in Equation (6.19) may be determined. Since  $\sigma_T = \sigma(1 + \epsilon)$  then

$$\sigma_{T1} = (315 \text{ MPa})(1 + 0.105) = 348 \text{ MPa}$$

$$\sigma_{T2} = (340 \text{ MPa})(1 + 0.220) = 415 \text{ MPa}$$

Similarly for strains, since  $\epsilon_T = \ln(1 + \epsilon)$  then

$$\epsilon_{T1} = \ln (1 + 0.105) = 0.09985$$

$$\epsilon_{T2} = \ln (1 + 0.220) = 0.19885$$

Taking logarithms of Equation (6.19), we get

$$\log \sigma_T = \log K + n \log \epsilon_T$$

which allows us to set up two simultaneous equations for the above pairs of true stresses and true strains, with  $\mathbf{K}$  and  $\mathbf{n}$  as unknowns. Thus

$$\log (348) = \log K + n \log (0.09985)$$

$$\log (415) = \log K + n \log (0.19885)$$

Solving for these two expressions yields  $\mathbf{K} = 628$  MPa and  $\mathbf{n} = 0.256$ .

Now, converting  $\epsilon = 0.28$  to true strain

$$\epsilon_T = \ln (1 + 0.28) = 0.247$$

The corresponding  $\sigma_T$  to give this value of  $\epsilon_T$  [using Equation (6.19)] is just

$$\sigma_T = K\epsilon_T^n = (628 \text{ MPa})(0.247)^{0.256} = 439 \text{ MPa}$$

Now converting this  $\sigma_T$  to an engineering stress

$$\sigma = \frac{\sigma_T}{1 + \epsilon} = \frac{439 \text{ MPa}}{1 + 0.28} = 343 \text{ MPa}$$

6.43 This problem calls for us to compute the toughness (or energy to cause fracture). The easiest way to do this is to integrate both elastic and plastic regions, and then add them together.

$$\begin{aligned} \text{Toughness} &= \int \sigma d\epsilon \\ &= \int_0^{0.01} E\epsilon d\epsilon + \int_{0.01}^{0.75} K\epsilon^n d\epsilon \\ &= \frac{E\epsilon^2}{2} \Bigg|_0^{0.01} + \frac{K}{(n+1)} \epsilon^{(n+1)} \Bigg|_{0.01}^{0.75} \end{aligned}$$

$$\begin{aligned}
&= \frac{172 \times 10^9 \text{ N/m}^2}{2} (0.01)^2 + \frac{6900 \times 10^6 \text{ N/m}^2}{(1.0 + 0.3)} \left[ (0.75)^{1.3} - (0.01)^{1.3} \right] \\
&= 3.65 \times 10^9 \text{ J/m}^3 \quad (5.29 \times 10^5 \text{ in.-lb}_f/\text{in.}^3)
\end{aligned}$$

6.44 This problem asks that we determine the value of  $\epsilon_T$  for the onset of necking assuming that necking begins when

$$\frac{d\sigma_T}{d\epsilon_T} = \sigma_T$$

Let us take the derivative of Equation (6.19), set it equal to  $\sigma_T$ , and then solve for  $\epsilon_T$  from the resulting expression. Thus

$$\frac{d[K(\epsilon_T)^n]}{d\epsilon_T} = Kn(\epsilon_T)^{(n-1)} = \sigma_T$$

However, from Equation (6.19),  $\sigma_T = K(\epsilon_T)^n$ , which, when substituted into the above expression, yields

$$Kn(\epsilon_T)^{(n-1)} = K(\epsilon_T)^n$$

Now solving for  $\epsilon_T$  from this equation leads to

$$\epsilon_T = n$$

as the value of the true strain at the onset of necking.

6.45 This problem calls for us to utilize the appropriate data from Problem 6.29 in order to determine the values of  $n$  and  $K$  for this material. From Equation (6.38) the slope and intercept of a  $\log \sigma_T$  versus  $\log \epsilon_T$  plot will yield values for  $n$  and  $\log K$ , respectively. However, Equation (6.19) is only valid in the region of plastic deformation to the point of necking; thus, only the 7th, 8th, 9th, and 10th data points may be utilized. The log-log plot with these data points is given below.



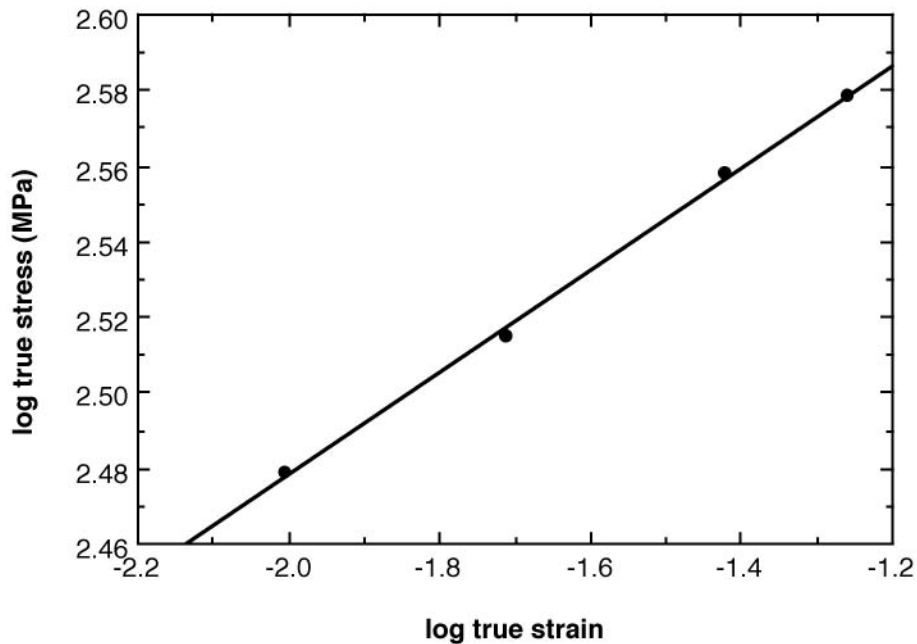

The slope yields a value of 0.136 for  $n$ , whereas the intercept gives a value of 2.7497 for  $\log K$ , and thus  $K = 562$  MPa.

- 6.46 (a) In order to determine the final length of the brass specimen when the load is released, it first becomes necessary to compute the applied stress using Equation (6.1); thus

$$\sigma = \frac{F}{A_o} = \frac{F}{\pi \left( \frac{d_o}{2} \right)^2} = \frac{11,750 \text{ N}}{\pi \left( \frac{10 \times 10^{-3} \text{ m}}{2} \right)^2} = 150 \text{ MPa (22,000 psi)}$$

Upon locating this point on the stress-strain curve (Figure 6.12), we note that it is in the linear, elastic region; therefore, when the load is released the specimen will return to its original length of 120 mm (4.72 in.).

- (b) In this portion of the problem we are asked to calculate the final length, after load release, when the load is increased to 23,500 N (5280  $l_b_f$ ). Again, computing the stress

$$\sigma = \frac{23,500 \text{ N}}{\pi \left( \frac{10 \times 10^{-3} \text{ m}}{2} \right)^2} = 300 \text{ MPa (44,200 psi)}$$

The point on the stress-strain curve corresponding to this stress is in the plastic region. We are able to estimate the amount of permanent strain by drawing a straight line parallel to the linear elastic region; this line intersects the strain axis at a strain of about 0.012 which is the amount of plastic strain. The final specimen length  $l_i$  may be determined from Equation (6.2) as

$$l_i = l_o(1 + \epsilon) = (120 \text{ mm})(1 + 0.012) = 121.44 \text{ mm (4.78 in.)}$$

6.47 (a) We are asked to determine both the elastic and plastic strains when a tensile force of 110,000 N (25,000  $lbf$ ) is applied to the steel specimen and then released. First it becomes necessary to determine the applied stress using Equation (6.1); thus

$$\sigma = \frac{F}{A_o} = \frac{F}{b_o d_o}$$

where  $b_o$  and  $d_o$  are cross-sectional width and depth (19 mm and 3.2 mm, respectively). Thus

$$\sigma = \frac{110,000 \text{ N}}{(19 \times 10^{-3} \text{ m})(3.2 \times 10^{-3} \text{ m})} = 1.810 \times 10^9 \text{ N/m}^2 = 1810 \text{ MPa (265,000 psi)}$$

From Figure 6.24, this point is in the plastic region so there will be both elastic and plastic strains present. The total strain at this point,  $\epsilon_t$ , is about 0.020. We are able to estimate the amount of permanent strain recovery  $\epsilon_e$  from Hooke's law, Equation (6.5) as

$$\epsilon_e = \frac{\sigma}{E}$$

And, since  $E = 207 \text{ GPa}$  for steel (Table 6.1)

$$\epsilon_e = \frac{1810 \text{ MPa}}{207 \times 10^3 \text{ MPa}} = 0.009$$

The value of the plastic strain,  $\epsilon_p$  is just the difference between the total and elastic strains; that is

$$\epsilon_p = \epsilon_t - \epsilon_e = 0.020 - 0.0087 = 0.011$$

(b) If the initial length is 610 mm (24.0 in.) then the final specimen length  $l_i$  may be determined from Equation (6.2) using the plastic strain value as

$$l_i = l_o(1 + \epsilon_p) = (610 \text{ mm})(1 + 0.011) = 616.7 \text{ mm (24.26 in.)}$$

6.48 (a) We are asked to compute the Brinell hardness for the given indentation. It is necessary to use the equation in Table 6.4 for HB, where  $P = 1000 \text{ kg}$ ,  $d = 2.50 \text{ mm}$ , and  $D = 10 \text{ mm}$ . Thus, the Brinell hardness is computed as

$$\begin{aligned} \text{HB} &= \frac{2P}{\pi D \left[ D - \sqrt{D^2 - d^2} \right]} \\ &= \frac{(2)(1000 \text{ kg})}{(\pi)(10 \text{ mm}) \left[ 10 \text{ mm} - \sqrt{(10 \text{ mm})^2 - (2.50 \text{ mm})^2} \right]} = 200.5 \end{aligned}$$

(b) This part of the problem calls for us to determine the indentation diameter  $d$  which will yield a 300 HB when  $P = 500 \text{ kg}$ . Solving for  $d$  from this equation in Table 6.4 gives

$$\begin{aligned} d &= \sqrt{D^2 - \left[ D - \frac{2P}{(\text{HB})\pi D} \right]^2} \\ &= \sqrt{(10 \text{ mm})^2 - \left[ 10 \text{ mm} - \frac{(2)(500 \text{ kg})}{(300)(\pi)(10 \text{ mm})} \right]^2} = 1.45 \text{ mm} \end{aligned}$$

6.49 This problem calls for estimations of Brinell and Rockwell hardnesses.

(a) For the brass specimen, the stress-strain behavior for which is shown in Figure 6.12, the tensile strength is 450 MPa (65,000 psi). From Figure 6.19, the hardness for brass corresponding to this tensile strength is about 125 HB or 70 HRB.

(b) The steel alloy (Figure 6.24) has a tensile strength of about 1970 MPa (285,000 psi). This corresponds to a hardness of about 560 HB or ~55 HRC from the line (extended) for steels in Figure 6.19.

6.50 This problem calls for us to specify expressions similar to Equations (6.20a) and (6.20b) for nodular cast iron and brass. These equations, for a straight line, are of the form

$$\text{TS} = C + (E)(\text{HB})$$

where **TS** is the tensile strength, **HB** is the Brinell hardness, and **C** and **E** are constants, which need to be determined.

One way to solve for **C** and **E** is analytically--establishing two equations from **TS** and **HB** data points on the plot, as

$$(TS)_1 = C + (E)(BH)_1$$

$$(TS)_2 = C + (E)(BH)_2$$

Solving for **E** from these two expressions yields

$$E = \frac{(TS)_1 - (TS)_2}{(HB)_2 - (HB)_1}$$

For nodular cast iron, if we make the arbitrary choice of **(HB)<sub>1</sub>** and **(HB)<sub>2</sub>** as 200 and 300, respectively, then, from Figure 6.19, **(TS)<sub>1</sub>** and **(TS)<sub>2</sub>** take on values of 87,000 psi (600 MPa) and 160,000 psi (1100 MPa), respectively. Substituting these values into the above expression and solving for **E** gives

$$E = \frac{87,000 \text{ psi} - 160,000 \text{ psi}}{200 \text{ HB} - 300 \text{ HB}} = 730 \text{ psi/HB} \quad (5.0 \text{ MPa/HB})$$

Now, solving for **C** yields

$$C = (TS)_1 - (E)(BH)_1$$

$$= 87,000 \text{ psi} - (730 \text{ psi/HB})(200 \text{ HB}) = -59,000 \text{ psi} \quad (-400 \text{ MPa})$$

Thus, for nodular cast iron, these two equations take the form

$$TS(\text{psi}) = -59,000 + 730 \times HB$$

$$TS(\text{MPa}) = -400 + 5.0 \times HB$$

Now for brass, we take **(HB)<sub>1</sub>** and **(HB)<sub>2</sub>** as 100 and 200, respectively, then, from Figure 6.19, **(TS)<sub>1</sub>** and **(TS)<sub>2</sub>** take on values of 54,000 psi (370 MPa) and 95,000 psi (660 MPa), respectively. Substituting these values into the above expression and solving for **E** gives

$$E = \frac{54,000 \text{ psi} - 95,000 \text{ psi}}{100 \text{ HB} - 200 \text{ HB}} = 410 \text{ psi/HB} \quad (2.9 \text{ MPa/HB})$$

Now, solving for **C** yields

$$C = (TS)_1 - (E)(BH)_1$$

$$= 54,000 \text{ psi} - (410 \text{ psi/HB})(100 \text{ HB}) = 13,000 \text{ psi} \quad (80 \text{ MPa})$$

Thus, for brass these two equations take the form

$$TS(\text{psi}) = 13,000 + 410 \times \text{HB}$$

$$TS(\text{MPa}) = 80 + 2.9 \times \text{HB}$$

6.51 The five factors that lead to scatter in measured material properties are the following: 1) test method; 2) variation in specimen fabrication procedure; 3) operator bias; 4) apparatus calibration; and 5) material inhomogeneities and/or compositional differences.

6.52 The average of the given hardness values is calculated using Equation (6.21) as

$$\begin{aligned} \overline{\text{HRG}} &= \frac{\sum_{i=1}^{18} \text{HRG}_i}{18} \\ &= \frac{47.3 + 52.1 + 45.6 \dots + 49.7}{18} = 48.4 \end{aligned}$$

And we compute the standard deviation using Equation (6.22) as follows:

$$\begin{aligned} s &= \sqrt{\frac{\sum_{i=1}^{18} (\text{HRG}_i - \overline{\text{HRG}})^2}{18 - 1}} \\ &= \left[ \frac{(47.3 - 48.4)^2 + (52.1 - 48.4)^2 + \dots + (49.7 - 48.4)^2}{17} \right]^{1/2} \end{aligned}$$

$$= \sqrt{\frac{64.95}{17}} = 1.95$$

6.53 The criteria upon which factors of safety are based are 1) consequences of failure, 2) previous experience, 3) accuracy of measurement of mechanical forces and/or material properties, and 4) economics.

6.54 The working stresses for the two alloys the stress-strain behaviors of which are shown in Figures 6.12 and 6.24 are calculated by dividing the yield strength by a factor of safety, which we will take to be 2. For the brass alloy (Figure 6.12), since  $\sigma_y = 250$  MPa (36,000 psi), the working stress is 125 MPa (18,000 psi), whereas for the steel alloy (Figure 6.24),  $\sigma_y = 1570$  MPa (228,000 psi), and, therefore,  $\sigma_w = 785$  MPa (114,000 psi).

### Design Problems

6.D1 For this problem the working stress is computed using Equation (6.24) with  $N = 2$ , as

$$\sigma_w = \frac{\sigma_y}{2} = \frac{860 \text{ MPa}}{2} = 430 \text{ MPa (62,500 psi)}$$

Since the force is given, the area may be determined from Equation (6.1), and subsequently the original diameter  $d_o$  may be calculated as

$$A_o = \frac{F}{\sigma_w} = \pi \left( \frac{d_o}{2} \right)^2$$

And

$$\begin{aligned} d_o &= \sqrt{\frac{4F}{\pi \sigma_w}} = \sqrt{\frac{(4)(13,300 \text{ N})}{\pi (430 \times 10^6 \text{ N/m}^2)}} \\ &= 6.3 \times 10^{-3} \text{ m} = 6.3 \text{ mm (0.25 in.)} \end{aligned}$$

6.D2 (a) This portion of the problem asks for us to compute the wall thickness of a thin-walled cylindrical Ni tube at 300°C through which hydrogen gas diffuses. The inside and outside pressures are, respectively, 1.013 and 0.01013 MPa, and the diffusion flux is to be no greater than  $1 \times 10^{-7}$  mol/m<sup>2</sup>-s. This is a steady-state diffusion problem, which necessitates that we employ Equation (5.3). The

concentrations at the inside and outside wall faces may be determined using Equation (6.39), and, furthermore, the diffusion coefficient is computed using Equation (6.40). Solving for  $\Delta x$

$$\begin{aligned} \Delta x &= -\frac{D \Delta C}{J} \\ &= \frac{1}{1 \times 10^{-7} \text{ mol/m}^2/\text{s}} \times \\ &\quad \left(4.76 \times 10^{-7}\right) \exp\left(-\frac{39,560 \text{ J/mol}}{(8.31 \text{ J/mol}\cdot\text{K})(300 + 273 \text{ K})}\right) \times \\ &\quad (30.8) \exp\left(-\frac{12,300 \text{ J/mol}}{(8.31 \text{ J/mol}\cdot\text{K})(300 + 273 \text{ K})}\right) \left(\sqrt{1.013 \text{ MPa}} - \sqrt{0.01013 \text{ MPa}}\right) \\ &= 0.0025 \text{ m} = 2.5 \text{ mm} \end{aligned}$$

(b) Now we are asked to determine the circumferential stress; from Equation (6.41)

$$\begin{aligned} \sigma &= \frac{r \Delta p}{4 \Delta x} \\ &= \frac{(1.013 \text{ MPa} - 0.01013 \text{ MPa})(0.1 \text{ m})}{(4)(0.0025 \text{ m})} \\ &= 10 \text{ MPa} \end{aligned}$$

(c) Now we are to compare this value of stress to the yield strength of Ni at 300°C, from which it is possible to determine whether or not the 2.5 mm wall thickness is suitable. From the information given in the problem, we may write an equation for the dependence of yield strength on temperature as follows:

$$\sigma_y = 100 \text{ MPa} - 0.1 \text{ MPa} (T - 20)$$

for temperature in degrees Celsius. Thus, at 300°C

$$\sigma_y = 100 \text{ MPa} - 0.1 \text{ MPa} (300 - 20) = 72 \text{ MPa}$$

Inasmuch as the circumferential stress (10 MPa) is much less than the yield strength (72 MPa), this thickness is entirely suitable.

(d) And, finally, this part of the problem asks that we specify how much this thickness may be reduced and still retain a safe design. Let us use a working stress by dividing the yield stress by a factor of safety, according to Equation (6.24). On the basis of our experience, let us use a value of 2.0 for **N**. Thus

$$\sigma_w = \frac{\sigma_y}{N} = \frac{72 \text{ MPa}}{2} = 36 \text{ MPa}$$

Using this value for  $\sigma_w$  and Equation (6.41), we now compute the tube thickness as

$$\begin{aligned} \Delta x &= \frac{r \Delta p}{4 \sigma_w} \\ &= \frac{(0.1 \text{ m})(1.013 \text{ MPa} - 0.01013 \text{ MPa})}{4(36 \text{ MPa})} \\ &= 0.0007 \text{ m} = 0.7 \text{ mm} \end{aligned}$$

Substitution of this value into Fick's first law [Equation (5.3)] we calculate the diffusion flux as follows:

$$\begin{aligned} J &= -D \frac{\Delta C}{\Delta x} \\ &= (4.76 \times 10^{-7}) \exp \left[ -\frac{39,560 \text{ J/mol}}{(8.31 \text{ J/mol-K})(300 + 273 \text{ K})} \right] \times \\ &\quad \frac{(30.8) \exp \left[ -\frac{12,300 \text{ J/mol}}{(8.31 \text{ J/mol-K})(300 + 273 \text{ K})} \right] (\sqrt{1.013 \text{ MPa}} - \sqrt{0.01013 \text{ MPa}})}{0.0007 \text{ m}} \\ &= 3.63 \times 10^{-7} \text{ mol/m}^2\text{-s} \end{aligned}$$

Thus, the flux increases by approximately a factor of 3.5, from  $1 \times 10^{-7}$  to  $3.63 \times 10^{-7}$  mol/m<sup>2</sup>-s with this reduction in wall thickness.



6.D3 This problem calls for the specification of a temperature and cylindrical tube wall thickness that will give a diffusion flux of  $5 \times 10^{-8} \text{ mol/m}^2\text{-s}$  for the diffusion of hydrogen in nickel; the tube radius is 0.125 m and the inside and outside pressures are 2.026 and 0.0203 MPa, respectively. There are probably several different approaches that may be used; and, of course, there is not one unique solution. Let us employ the following procedure to solve this problem: 1) assume some wall thickness, and, then, using Fick's first law for diffusion [which also employs Equations (5.3) and (5.8)], compute the temperature at which the diffusion flux is that required; 2) compute the yield strength of the nickel at this temperature using the dependence of yield strength on temperature as stated in Problem 6.D2; 3) calculate the circumferential stress on the tube walls using Equation (6.41); and 4) compare the yield strength and circumferential stress values--the yield strength should probably be at least twice the stress in order to make certain that no permanent deformation occurs. If this condition is not met then another iteration of the procedure should be conducted with a more educated choice of wall thickness.

As a starting point, let us arbitrarily choose a wall thickness of 2 mm ( $2 \times 10^{-3} \text{ m}$ ). The steady-state diffusion equation, Equation (5.3), takes the form

$$\begin{aligned}
 J &= -D \frac{\Delta C}{\Delta x} \\
 &= 5 \times 10^{-8} \text{ mol/m}^2\text{-s} \\
 &= (4.76 \times 10^{-7}) \exp \left[ -\frac{39,560 \text{ J/mol}}{(8.31 \text{ J/mol-K})(T)} \right] \times \\
 &\frac{(30.8) \exp \left[ -\frac{12,300 \text{ J/mol}}{(8.31 \text{ J/mol-K})(T)} \right] (\sqrt{2.026 \text{ MPa}} - \sqrt{0.0203 \text{ MPa}})}{0.002 \text{ m}}
 \end{aligned}$$

Solving this expression for the temperature  $T$  gives  $T = 514 \text{ K} = 241^\circ\text{C}$ .

The next step is to compute the stress on the wall using Equation (6.41); thus

$$\begin{aligned}
 \sigma &= \frac{r \Delta p}{4 \Delta x} \\
 &= \frac{(0.125 \text{ m})(2.026 \text{ MPa} - 0.0203 \text{ MPa})}{(4)(2 \times 10^{-3} \text{ m})}
 \end{aligned}$$

$$= 31.3 \text{ MPa}$$

Now, the yield strength of Ni at this temperature may be computed as

$$\sigma_y = 100 \text{ MPa} - 0.1 \text{ MPa} (241^\circ\text{C} - 20^\circ\text{C}) = 77.9 \text{ MPa}$$

Inasmuch as this yield strength is greater than twice the circumferential stress, wall thickness and temperature values of 2 mm and 241°C, respectively, are satisfactory design parameters.

6.D4 (a) This portion of the problem asks for us to determine which of the materials listed in the database of Appendix B (or contained on the CD-ROM) have torsional strength performance indices greater than 12.5 (in SI units) and, in addition, shear strengths greater than 300 MPa. To begin, it is noted in Section 6.13 that the shear yield strength,  $\tau_y = 0.6\sigma_y$ . On this basis, and given that

$P = \frac{\tau_y^{2/3}}{\rho}$  [Equation (6.33) in the textbook], it follows that

$$P = \frac{(0.6\sigma_y)^{2/3}}{\rho}$$

Thus, the minimum value of the performance index in terms of yield strength value is  $(12.5)/(0.6)^{2/3} = 17.57$ . When a ratio query is performed on the CD-ROM for  $\frac{\tau_y^{2/3}}{\rho}$  using a minimum value of

17.57, ten metal alloys are found to satisfy this criterion; these are listed in the table below.

Alloy	Condition	$\frac{(0.6\sigma_y)^{2/3}}{\rho}$	$\sigma_y$
4340 Steel	Q/T, 315°C	17.57	1620
440A Stainless	Q/T, 315°C	17.90	1650
2024 Al	T3	17.75	345
7075 Al	T6	22.64	505
7075 Al	T651	22.64	505
AZ31B Mg	Rolled	20.59	220
AZ31B Mg	Extruded	19.32	200
Ti-5Al-2.5Sn	Annealed	18.59	760

Ti-6Al-4V	Annealed	19.94	830
Ti-6Al-4V	Aged	24.10	1103

Now, the second criterion calls for the material to have a shear strength greater than 300 MPa. Again, since  $\sigma_y = \tau_y/0.6$ , the minimum yield strength required is  $\sigma_y = 300 \text{ MPa}/0.6$ , or  $\sigma_y = 500 \text{ MPa}$ . Values of  $\sigma_y$  from the database are also given in this table. It is noted that the 2024 Al and both magnesium alloys are eliminated on the basis of this second criterion.

(b) This portion of the problem calls for us to conduct a cost analysis for these seven remaining alloys. Below is given a tabulation of values for  $\frac{\rho}{(0.6\sigma_y)^{2/3}}$ , relative cost  $\bar{c}$  (as taken from

Appendix C), and the product of these two parameters. (It should be noted that no values of  $\bar{c}$  are given for four of these materials.) The three remaining materials are ranked on the basis of cost, from least to most expensive.

Alloy	Condition	$\frac{\rho}{(0.6\sigma_y)^{2/3}}$	$\bar{c}$	$(\bar{c})\frac{\rho}{(0.6\sigma_y)^{2/3}}$
7075 Al	T6	0.0621	13.4	0.832
Ti-6Al-4V	Annealed	0.0705	132	9.31
Ti-5Al-2.5Sn	Annealed	0.0756	157	11.87
Ti-6Al-4V	Aged	0.0583	--	--
4340 Steel	Q/T, 315°C	0.0800	--	--
440A Stain.	Q/T, 315°C	0.0785	--	--
7075 Al	T651	0.0621	--	--

Thus, the 7075-T6 aluminum alloy is the overwhelming choice of the three materials for which cost data are given since it has the lowest value for the  $(\bar{c})\left[\rho/(0.6\sigma_y)^{2/3}\right]$  product.

6.D5 This problem asks that we conduct a stiffness-to-mass performance analysis on a solid cylindrical shaft that is subjected to a torsional stress. The stiffness performance index  $P_s$  is given as Equation (6.35) in the textbook:

$$P_s = \frac{\sqrt{G}}{\rho}$$

in which  $G$  is the shear modulus and  $\rho$  is the density. Densities for the five materials are tabulated in Table 6.6. Shear moduli for the glass- and fiber-reinforced composites were stipulated in the problem (8.6 and 9.2 GPa, respectively). For the three metal alloys, values of the shear modulus may be computed using Equation (6.9) and the values of the modulus of elasticity and Poisson's ratio given in Tables B.2 and B.3 in Appendix B. For example, for the 2024-T6 aluminum alloy

$$G = \frac{E}{2(1 + \nu)}$$

$$= \frac{72.4 \text{ GPa}}{2(1 + 0.33)} = 27.2 \text{ GPa}$$

Values of  $G$  for the titanium alloy and 4340 steel are, respectively, 42.5 and 79.6 GPa.

Below are tabulated the density, shear modulus, and stiffness performance index for these five materials.

Material	$\rho$ (Mg/m <sup>3</sup> )	$G$ (GPa)	$\frac{\sqrt{G}}{\rho}$ [(GPa) <sup>1/2</sup> m <sup>3</sup> /Mg]
Carbon fiber-reinforced composite	1.5	9.2	2.02
Aluminum alloy (2024-T6)	2.8	27.2	1.86
Titanium alloy (Ti-6Al-4V)	4.4	42.5	1.48
Glass fiber-reinforced composite	2.0	8.6	1.47
4340 Steel (oil-quenched and tempered)	7.8	79.6	1.14

Thus, the carbon fiber-reinforced composite has the highest stiffness performance index,  $\frac{\rho}{\sqrt{G}}$ , and the tempered steel the least.

The table shown below contains the reciprocal of the performance index in the first column, the relative cost ( $\bar{c}$ ), and the product of these two factors, which provides a comparison of the relative costs of the materials to be used for this torsional shaft, when stiffness is an important consideration.

Material	$\frac{\rho}{\sqrt{G}}$ [Mg/(GPa) <sup>1/2</sup> m <sup>3</sup> ]	$\bar{c}$ (\$/\$)	$\bar{c} \left( \frac{\rho}{\sqrt{G}} \right)$ [(\$/\$) {Mg/(GPa) <sup>1/2</sup> m <sup>3</sup> }]
4340 Steel (oil-quenched and tempered)	0.877	5	4.39
Aluminum alloy (2024-T6)	0.538	15	8.06
Glass fiber-reinforced composite	0.680	40	27.2
Carbon fiber-reinforced composite	0.495	80	39.6
Titanium alloy (Ti-4Al-6V)	0.676	110	74.4

Thus, a shaft constructed of the tempered steel would be the least expensive, whereas the most costly shaft would employ the titanium alloy.

6.D6 (a) This portion of the problem asks that we derive a performance index expression for strength analogous to Equation (6.33) for a cylindrical cantilever beam that is stressed in the manner shown in the accompanying figure. The stress on the unfixed end,  $\sigma$ , for an imposed force,  $\mathbf{F}$ , is given by the expression [Equation (6.42) in the textbook]

$$\sigma = \frac{FLr}{I} \quad (6.D1)$$

where  $\mathbf{L}$  and  $\mathbf{r}$  are the rod length and radius, respectively, and  $\mathbf{I}$  is the moment of inertia; for a cylinder the expression for  $\mathbf{I}$  is provided in Figure 12.29:

$$I = \frac{\pi r^4}{4} \quad (6.D2)$$

Substitution for **I** into Equation (6.D1) leads to

$$\sigma = \frac{4FL}{\pi r^3} \quad (6.D3)$$

Now, the mass **m** of some given quantity of material is the product of its density (**ρ**) and volume. Inasmuch as the volume of a cylinder is just  $\pi r^2 L$ , then

$$m = \pi r^2 L \rho \quad (6.D4)$$

From this expression, the radius is just

$$r = \sqrt{\frac{m}{\pi L \rho}} \quad (6.D5)$$

Inclusion of Equation (6.D5) into Equation (6.D3) yields

$$\sigma = \frac{4F\pi^{1/2}L^{5/2}\rho^{3/2}}{m^{3/2}} \quad (6.D6)$$

And solving for the mass gives

$$m = \left(16\pi F^2 L^5\right)^{1/3} \frac{\rho}{\sigma^{2/3}} \quad (6.D7)$$

To ensure that the beam will not fail, we replace stress in Equation (6.D7) with the yield strength ( $\sigma_y$ ) divided by a factor of safety (**N**) as

$$m = \left(16\pi F^2 L^5 N^2\right)^{1/3} \frac{\rho}{\sigma_y^{2/3}} \quad (6.D8)$$

Thus, the best materials to be used for this cylindrical cantilever beam when strength is a consideration are those having low  $\frac{\rho}{\sigma_y^{2/3}}$  ratios. Furthermore, the strength performance index, **P**, is

just the reciprocal of this ratio, or

$$P = \frac{\sigma^{2/3} y}{\rho} \quad (6.D9)$$

The second portion of the problem asks for an expression for the stiffness performance index. Let us begin by consideration of Equation (6.43) which relates  $\delta$ , the elastic deflection at the unfixed end, to the force (**F**), beam length (**L**), the modulus of elasticity (**E**), and moment of inertia (**I**) as

$$\delta = \frac{FL^3}{3EI} \quad (6.43)$$

Again, Equation (6.D2) gives an expression for **I** for a cylinder, which when substituted into Equation (6.43) yields

$$\delta = \frac{4FL^3}{3\pi E r^4} \quad (6.D10)$$

And, substitution of the expression for **r** [Equation (6.D5)] into Equation (6.D10), leads to

$$\begin{aligned} \delta &= \frac{4FL^3}{3\pi E \left( \sqrt{\frac{m}{\pi L \rho}} \right)^4} \\ &= \frac{4FL^5 \pi \rho^2}{3Em^2} \end{aligned} \quad (6.D11)$$

Now solving this expression for the mass **m** yields

$$m = \left( \frac{4FL^5 \pi}{3\delta} \right)^{1/2} \frac{\rho}{\sqrt{E}} \quad (6.D12)$$

Or, for this cantilever situation, the mass of material experiencing a given deflection produced by a specific force is proportional to the  $\frac{\rho}{\sqrt{E}}$  ratio for that material. And, finally, the stiffness performance

index, **P**, is just the reciprocal of this ratio, or

$$P = \frac{\sqrt{E}}{\rho} \quad (6.D13)$$

(b) Here we are asked to select those metal alloys in the database that have stiffness performance indices greater than 3.0 (in SI units). (**Note:** for this performance index of 3.0, density has been taken in terms of  $\text{g/cm}^3$  rather than in the SI units of  $\text{kg/m}^3$ .) Seventeen metal alloys satisfy this criterion; they and their  $\sqrt{E}/\rho$  values are listed below, and ranked from highest to lowest value.

Alloy	Condition	$\frac{\sqrt{E}}{\rho}$
AZ31B Mg	Rolled	3.790
AZ31B Mg	Extruded	3.790
AZ91D Mg	As cast	3.706
356.0 Al	As cast, high production	3.163
356.0 Al	As cast, custom	3.163
356.0 Al	T6	3.163
6061 Al	O	3.077
6061 Al	T6	3.077
6061 Al	T651	3.077
2024 Al	O	3.072
2024 Al	T3	3.072
2024 Al	T351	3.072
1100 Al	O	3.065
1100 Al	H14	3.065
7075 Al	O	3.009
7075 Al	T6	3.009
7075 Al	T651	3.009

(c) We are now asked to do a cost analysis on the above alloys. Below are tabulated the  $\frac{\rho}{\sqrt{E}}$  ratio, the relative material cost ( $\bar{c}$ ), and the product of these two parameters; also those alloys for which cost data are provided are ranked, from least to most expensive.



Alloy	Condition	$\frac{\rho}{\sqrt{E}}$	$\bar{c}$	$\bar{c} \left( \frac{\rho}{\sqrt{E}} \right)$
AZ91D Mg	As cast	0.2640	5.4	1.43
6061 Al	T6	0.3250	7.6	2.47
356.0 Al	As cast, high production	0.3162	7.9	2.50
6061 Al	T651	0.3250	8.7	2.83
AZ31B Mg	Extruded	0.2640	12.6	3.33
1100 Al	O	0.3263	12.3	4.01
AZ31B Mg	Rolled	0.2640	15.7	4.14
7075 Al	T6	0.3323	13.4	4.45
2024 Al	T3	0.3255	14.1	4.59
356.0 Al	As cast, custom	0.3162	15.7	4.96
356.0 Al	T6	0.3162	16.6	5.25
2024 Al	T351	0.3255	16.2	5.27
1100 Al	H14	0.3263	--	--
2024 Al	O	0.3255	--	--
6061 Al	O	0.3250	--	--
7075 Al	O	0.3323	--	--
7075 Al	T651	0.3323	--	--

It is up to the student to select the best metal alloy to be used for this cantilever beam on a stiffness-per-mass basis, including the element of cost, and other relevant considerations.

(d) We are now asked to select those metal alloys in the database that have strength performance indices greater than 18.0 (in SI units). (**Note:** for this performance index of 18.0, density has been taken in terms of  $\text{g/cm}^3$  rather than in the SI units of  $\text{kg/m}^3$ .) Seven alloys satisfy this criterion; they and their  $\frac{\sigma_y^{2/3}}{\rho}$  ratios [Equation (6.D9)] are listed below; here they are ranked from highest to lowest ratio value.

Alloy	Condition	$\frac{\sigma_y^{2/3}}{\rho}$
-------	-----------	-------------------------------

Ti-6Al-4V	Soln. treated/aged	24.10
7075 Al	T6	22.65
7075 Al	T651	22.65
AZ31B Mg	Rolled	20.59
Ti-6Al-4V	Annealed	19.94
AZ31B Mg	Extruded	19.32
Ti-5Al-2.5Sn	Annealed	18.59

(e) We are now asked to do a cost analysis on the above alloys. Below are tabulated the  $\frac{\rho}{\sigma_y^{2/3}}$  values, the relative material cost ( $\bar{c}$ ), and the product of these two parameters; also those alloys for which cost data are provided are ranked, from least to most expensive.

Alloy	Condition	$10^{-2} \frac{\rho}{\sigma_y^{2/3}}$	$\bar{c}$	$\bar{c} \left( \frac{\rho}{\sigma_y^{2/3}} \right)$
7075 Al	T6	4.42	13.4	0.592
AZ31B Mg	Extruded	5.18	12.6	0.653
AZ31B Mg	Rolled	4.86	15.7	0.763
Ti-6Al-4V	Soln. treated/aged	4.15	132	5.48
Ti-6Al-4V	Annealed	5.02	132	6.63
Ti-5Al-2.5Sn	Annealed	5.38	157	8.45
7075 Al	T651	4.42	--	--

It is up to the student to select the best metal alloy to be used for this cantilever beam on a stiffness-per-mass basis, including the element of cost and any other relevant considerations.

(f) The student should use his or her own discretion in selecting the material to be used for this application when stiffness- and strength-per-mass, as well as cost are to be considered. Furthermore, the student should be able to justify the decision.

6.D7 (a) This portion of the problem asks that we derive strength and stiffness performance index expressions analogous to Equations (6.33) and (6.35) for a bar specimen having a square cross-section that is pulled in uniaxial tension along its longitudinal axis.

For stiffness, we begin by consideration of the elongation,  $\Delta l$ , in Equation (6.2) where the initial length  $l_0$  is replaced by  $L$ . Thus, Equation (6.2) may now be written as

$$\Delta l = L\varepsilon \quad (6.D14)$$

in which  $\varepsilon$  is the engineering strain. Furthermore, assuming that the deformation is entirely elastic, Hooke's law, Equation (6.5), is obeyed by this material (i.e.,  $\sigma = E\varepsilon$ ), where  $\sigma$  is the engineering stress. Thus

$$\Delta l = L\varepsilon = \frac{L\sigma}{E} \quad (6.D15)$$

And, since  $\sigma$  is defined by Equation (6.1) as

$$\sigma = \frac{F}{A_0} \quad (6.1)$$

$A_0$  being the original cross-sectional area; in this case  $A_0 = c^2$ . Thus, incorporation of these relationships into Equation (6.D15) leads to an expression for  $\Delta l$  as

$$\Delta l = \frac{LF}{Ec^2} \quad (6.D16)$$

The mass of material,  $m$ , is just the product of the density,  $\rho$ , and the volume of the beam, which volume is just  $Lc^2$ ; that is

$$m = \rho Lc^2 \quad (6.D17)$$

Or

$$c^2 = \frac{m}{\rho L} \quad (6.D18)$$

Substitution for  $c^2$  into Equation (6.D16) yields

$$\Delta l = \frac{L^2 F \rho}{Em} \quad (6.D19)$$

And solving for the mass

$$m = \left( \frac{L^2 F}{\Delta l} \right) \frac{\rho}{E} \quad (6.D20)$$

Thus, the best materials to be used for a light bar that is pulled in tension when stiffness is a consideration are those having low  $\rho/E$  ratios. The stiffness performance index,  $P_s$ , is the reciprocal of this ratio, or

$$P_s = \frac{E}{\rho} \quad (6.D21)$$

Now we will consider rod strength. The stress  $\sigma$  imposed on this beam by  $F$  may be determined using Equation (6.1); that is

$$\sigma = \frac{F}{A_o} = \frac{F}{c^2} \quad (6.D22)$$

In the stiffness treatment [(Equation (6.D18))] it was shown that  $c^2 = m/\rho L$ , and thus

$$\sigma = \frac{FL\rho}{m} \quad (6.D23)$$

Now, solving for the mass,  $m$ , leads to

$$m = (FL) \frac{\rho}{\sigma} \quad (6.D24)$$

And replacement of stress with yield strength,  $\sigma_y$ , divided by a factor of safety,  $N$

$$m = (FLN) \frac{\rho}{\sigma_y} \quad (6.D25)$$

Hence, the best materials to be used for a light bar that is pulled in tension when strength is a consideration are those having low  $\rho/\sigma_y$  ratios; and the strength performance index,  $P$ , is just the reciprocal of this ratio, or

$$P = \frac{\sigma_y}{\rho} \quad (6.D26)$$

(b) Here we are asked to select those metal alloys in the database that have stiffness performance indices [i.e.,  $E/\rho$  ratios, Equation (6.D21)] greater than 26.3 (in SI units). (**Note:** for this performance index of 26.3, density has been taken in terms of  $\text{g/cm}^3$  rather than in the SI units of  $\text{kg/m}^3$ .) Twenty seven metal alloys satisfy this criterion. All of the twenty-one plain carbon and low alloy steels contained in the database fall into this group, and, in addition several other alloys. These  $E/\rho$  ratios are listed below, and are ranked from highest to lowest value. (All of the twenty one steel alloys have the same  $E/\rho$  ratio, and therefore are entered as a single item in the table.) These materials are ranked from highest to lowest ratio.

Alloy(s)	Condition	$\frac{E}{\rho}$
Molybdenum	Sheet/rod	31.31
356.0 Al	As cast, high production	26.91
356.0 Al	As cast, custom	26.91
356.0 Al	T6	26.91
17-7PH stainless	Plate, CR	26.67
17-7PH stainless	Pptn. hardened	26.67
Plain carbon/low alloy steels	Various	26.37

(c) We are now asked to do a cost analysis on the above alloys. Below are tabulated the  $\rho/E$  ratio, the relative material cost ( $\bar{c}$ ), and the product of these two parameters; only those alloys in the previous table for which cost data are given are included in the table; these are ranked, from least to most expensive.

Alloy	Condition	$10^{-2} \frac{\rho}{E}$	$\bar{c}$	$10^{-2} \bar{c} \left( \frac{\rho}{E} \right)$
1020 steel	Plate, HR	3.79	0.8	3.03
A36 steel	Plate, HR	3.79	1.0	3.79

1040 steel	Plate, HR	3.79	1.1	4.17
A36 steel	Angle bar, HR	3.79	1.6	6.06
1020 steel	Plate, CR	3.79	1.6	6.06
1040 steel	Plate, CR	3.79	1.9	7.20
4140 steel	Bar, normalized	3.79	2.6	9.85
4340 steel	Bar, annealed	3.79	3.5	13.3
4140H steel	Round, normalized	3.79	4.2	15.9
4340 steel	Bar, normalized	3.79	4.7	17.8
356.0 Al	Cast, high prod.	3.72	7.9	29.4
17-7PH SS	Plate, CR	3.75	12	45.0
356.0 Al	Cast, custom	3.72	15.7	58.4
356.0 Al	T6	3.72	16.6	61.8
Molybdenum	Sheet/rod	3.19	143	456

---

It is up to the student to select the best metal alloy to be used for this bar pulled in tension on a stiffness-per-mass basis, including the element of cost and other relevant considerations.

(d) We are now asked to select those metal alloys in the database that have strength performance indices greater than 100 (in SI units). (**Note:** for this performance index of 100, density has been taken in terms of  $\text{g/cm}^3$  rather than in the SI units of  $\text{kg/m}^3$ .) Eighteen alloys satisfy this criterion; they and their  $\sigma_y/\rho$  ratios [per Equation (6.D26)] are listed below; here the ranking is from highest to lowest ratio value.

Alloy	Condition	$\frac{\sigma_y}{\rho}$
Ti-6Al-4V	Soln. treated/aged	249
440A stainless	Q/T, 315°C	212
4340 steel	Q/T, 315°C	206
4140 steel	Q/T, 315°C	200
Ti-6Al-4V	Annealed	187
7075 Al	T6	180
7075 Al	T651	180
17-7PH stainless	Pptn. hardened	171
Ti-5Al-2.5Sn	Annealed	170
17-7PH stainless	Plate, CR	158
C17200 Cu	Soln. treated/aged	132
2024 Al	T3	125
AZ31B Mg	Sheet, rolled	124
2024 Al	T351	117
AZ31B Mg	Sheet, extruded	113
4340 steel	Normalized @870°C	110
6061 Al	T6	102
6061 Al	T651	102

(e) We are now asked to do a cost analysis on the above alloys. Below are tabulated the  $\rho/\sigma_y$  values, the relative material cost ( $\bar{c}$ ), and the product of these two parameters; also those alloys for which cost data are provided are ranked, from least to most expensive.

Alloy	Condition	$10^{-3} \frac{\rho}{\sigma_y}$	$\bar{c}$	$10^{-2} \bar{c} \left( \frac{\rho}{\sigma_y} \right)$
4340 steel	Normalized @ 870°C	9.09	4.7	4.3
6061 Al	T6	9.80	7.6	7.4
7075 Al	T6	5.56	13.4	7.5

17-7PH SS	Plate, CR	6.33	12.0	7.6
6061 Al	T651	9.80	8.7	8.5
AZ31B Mg	Sheet, extruded	8.85	12.6	11.2
2024 Al	T3	8.00	14.1	11.3
AZ31B Mg	Sheet, rolled	8.06	15.7	12.7
2024 Al	T351	8.55	16.2	13.9
C17200 Cu	Soln. treated/aged	7.58	51.4	39.0
Ti-6Al-4V	Soln. treated/aged	4.02	132	53.1
Ti-6Al-4V	Annealed	5.35	132	70.6
Ti-5Al-2.5Sn	Annealed	5.88	157	92.3
440A SS	Q/T, 315°C	4.72	--	--
4340 steel	Q/T, 315°C	4.85	--	--
4140 steel	Q/T, 315°C	5.00	--	--
7075 Al	T651	5.56	--	--
17-7PH SS	Pptn. hardened	5.85	--	--

---

It is up to the student to select the best metal alloy to be used for this bar pulled in tension on a strength-per-mass basis, including the element of cost and other relevant considerations.

(f) The student should use his or her own discretion in the selection the material to be used for this application when stiffness- and strength-per-mass, as well as cost are to be considered. Furthermore, the student should be able to justify the decision.

6.D8 (a) The first portion of this problem asks that we derive a performance index expression for the strength for a plate that is supported at its ends and subjected to a force that is uniformly distributed over the upper face. Equation (6.44) in the textbook is an expression for the deflection  $\delta$  of the underside of the plate at  $L/2$  in terms of the force  $F$ , the modulus of elasticity  $E$ , as well as the plate dimensions as shown in the accompanying figure. This equation is as follows:

$$\delta = \frac{5FL^3}{32Ewt^3} \quad (6.D27)$$

Now, the mass  $m$  of the plate is the product of its density ( $\rho$ ) and volume. Inasmuch as the volume of the plate is  $Lwt$ , then



$$m = Lwt\rho \quad (6.D28)$$

From this expression, the thickness  $t$  is just

$$t = \frac{m}{Lw\rho} \quad (6.D29)$$

Inclusion of Equation (6.D29) into Equation (6.D27) yields

$$\delta = \frac{5FL^6w^2\rho^3}{32Em^3} \quad (6.D30)$$

And solving for the mass gives

$$m = \left( \frac{5FL^6w^2}{32\delta} \right)^{1/3} \frac{\rho}{E^{1/3}} \quad (6.D31)$$

Now, the stiffness performance index  $P_1$  is just the reciprocal of the  $\frac{\rho}{E^{1/3}}$  term of this expression, or

$$P_1 = \frac{E^{1/3}}{\rho} \quad (6.D32)$$

For determination of the strength performance index, we substitute the expression for  $t$  [Equation (6.D29)] into Equation (6.45) in the textbook, which yields

$$\sigma = \frac{3FL^3w\rho^2}{4m^2} \quad (6.D33)$$

Now, as in the previous problems, in order to ensure that the plate will not fail, we replace stress in the previous expression with the yield strength ( $\sigma_y$ ) divided by a factor of safety ( $N$ ) as

$$\frac{\sigma_y}{N} = \frac{3FL^3w\rho^2}{4m^2} \quad (6.D34)$$

Now solving Equation (6.D34) for the mass

$$m = \left( \frac{3NFL^3w}{4} \right)^{1/2} \frac{\rho}{\sigma_y^{1/2}} \quad (6.D35)$$

And, finally, the stiffness performance index  $P_2$  is the reciprocal of the  $\frac{\rho}{\sigma_y^{1/2}}$  ratio as

$$P_2 = \frac{\sigma_y^{1/2}}{\rho} \quad (6.D36)$$

(b) Here we are asked to select those metal alloys in the database that have stiffness performance indices [i.e.,  $\frac{E^{1/3}}{\rho}$  ratios, Equation (6.D32)] greater than 1.50 (in SI units). (**Note:** for this performance index of 1.50, density has been taken in terms of  $\text{g/cm}^3$  rather than in the SI units of  $\text{kg/m}^3$ .) Fourteen metal alloys satisfy this criterion. They and their  $\frac{E^{1/3}}{\rho}$  ratios are listed below. Furthermore, these materials are ranked from highest to lowest ratio.

Alloy	Condition	$\frac{E^{1/3}}{\rho}$
AZ31B Mg	Rolled	2.010
AZ31B Mg	Extruded	2.010
AZ91B Mg	As cast	1.965
356.0 Al	Cast, high production	1.549
356.0 Al	As cast, custom	1.549
356.0 Al	T6	1.549
6061 Al	O	1.519
6061 Al	T6	1.519
6061 Al	T651	1.519
1100 Al	O	1.513
1100 Al	H14	1.513
2024 Al	O	1.505
2024 Al	T3	1.505
2024 Al	T351	1.505

(c) We are now asked to do a cost analysis on the above alloys. Below are tabulated the  $\frac{\rho}{E^{1/3}}$  ratio, the relative material cost ( $\bar{c}$ ), and the product of these two parameters; these alloys are ranked from least to most expensive.

Alloy	Condition	$\frac{\rho}{E^{1/3}}$	$\bar{c}$	$\bar{c} \left( \frac{\rho}{E^{1/3}} \right)$
AZ91B Mg	As cast	0.509	5.4	2.75
6061 Al	T6	0.658	7.6	5.00
356.0 Al	Cast, high production	0.645	7.9	5.10
6061 Al	T651	0.658	8.7	5.72
AZ31B Mg	Extruded	0.498	12.6	6.27
AZ31B Mg	Rolled	0.498	15.7	7.82
1100 Al	O	0.661	12.3	8.13
2024 Al	T3	0.665	14.1	9.38
356.0 Al	Cast, custom	0.645	15.7	10.13
356.0 Al	T6	0.645	16.6	10.71
2024 Al	T351	0.665	16.2	10.77
1100 Al	H14	0.661	--	--
2024 Al	O	0.665	--	--
6061 Al	O	0.658	--	--

It is up to the student to select the best metal alloy to be used for this plate on a stiffness-per-mass basis, including the element of cost, as well as other relevant considerations.

(d) We are now asked to select those metal alloys in the database that have strength performance indices greater than 6.0 (in SI units). (**Note:** for this performance index of 6.0, density has been taken in terms of  $\text{g/cm}^3$  rather than in the SI units of  $\text{kg/m}^3$ .) Twelve alloys satisfy this criterion; they and their  $\frac{\sigma_y^{1/2}}{\rho}$  ratios [per Equation (6.D36)] are listed below; here the ranking is from highest to lowest ratio value.

Alloy	Condition	$\frac{\sigma_y^{1/2}}{\rho}$
AZ31B Mg	Sheet, rolled	8.380
AZ31B Mg	Sheet, extruded	8.380
7075 Al	T6	8.026
7075 Al	T651	8.026
Ti-6Al-4V	Soln. treated/aged	7.497
2024 Al	T3	6.706
2024 Al	T351	6.508
Ti-6Al-4V	Annealed	6.503
Ti-5Al-2.5Sn	Annealed	6.154
6061 Al	T6	6.153
6061 Al	T651	6.153
AZ91D Mg	As cast	6.104

(e) We are now asked to do a cost analysis on the above alloys. Below are tabulated the  $\frac{\rho}{\sigma_y^{1/2}}$  values, the relative material cost ( $\bar{c}$ ), and the product of these two parameters; also those alloys for which cost data are provided are ranked, from least to most expensive.

Alloy	Condition	$\frac{\rho}{\sigma_y^{1/2}}$	$\bar{c}$	$\bar{c} \left( \frac{\rho}{\sigma_y^{1/2}} \right)$
AZ91D Mg	As cast	0.1639	5.4	0.885
6061 Al	T6	0.1625	7.6	1.24
6061 Al	T651	0.1625	8.7	1.41
AZ31B Mg	Sheet, extruded	0.1193	12.6	1.50
7075 Al	T6	0.1246	13.4	1.67
AZ31B Mg	Sheet, rolled	0.1193	15.7	1.87
2024 Al	T3	0.1491	14.1	2.10
2024 Al	T351	0.1537	16.2	2.49

Ti-6Al-4V	Soln. treated/aged	0.1334	132	17.61
Ti-6Al-4V	Annealed	0.1538	132	20.30
Ti-5Al-2.5Sn	Annealed	0.1625	157	25.51
7075 Al	T651	0.1246	--	--

---

It is up to the student to select the best metal alloy to be used for this plate on a strength-per-mass basis, including the element of cost, as well as other relevant considerations.

(f) The student should use his or her own discretion in the selection the material to be used for this application when stiffness- and strength-per-mass, as well as cost are to be considered. Furthermore, the student should be able to justify the decision.

## CHAPTER 7

### DISLOCATIONS AND STRENGTHENING MECHANISMS

#### PROBLEM SOLUTIONS

- 7.1 The dislocation density is just the total dislocation length per unit volume of material (in this case per cubic millimeters). Thus, the total length in  $1000 \text{ mm}^3$  of material having a density of  $10^5 \text{ mm}^{-2}$  is just

$$(10^5 \text{ mm}^{-2})(1000 \text{ mm}^3) = 10^8 \text{ mm} = 10^5 \text{ m} = 62 \text{ mi}$$

Similarly, for a dislocation density of  $10^9 \text{ mm}^{-2}$ , the total length is

$$(10^9 \text{ mm}^{-2})(1000 \text{ mm}^3) = 10^{12} \text{ mm} = 10^9 \text{ m} = 6.2 \times 10^5 \text{ mi}$$

- 7.2 When the two edge dislocations become aligned, a planar region of vacancies will exist between the dislocations as:

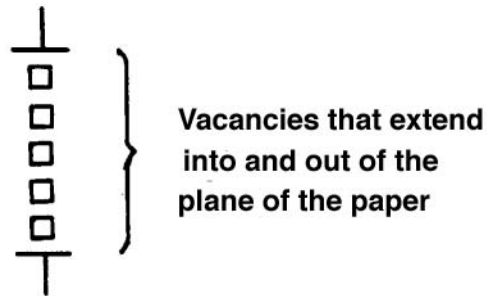

- 7.3 It is possible for two screw dislocations of opposite sign to annihilate one another if their dislocation lines are parallel. This is demonstrated in the figure below.

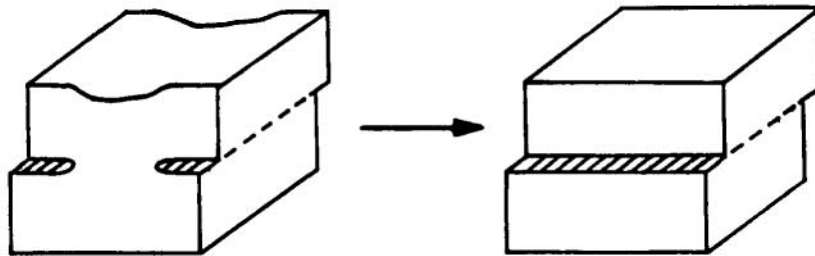

7.4 For the various dislocation types, the relationships between the direction of the applied shear stress and the direction of dislocation line motion are as follows:

edge dislocation--parallel

screw dislocation--perpendicular

mixed dislocation--neither parallel nor perpendicular

7.5 (a) A slip system is a crystallographic plane, and, within that plane, a direction along which dislocation motion (or slip) occurs.

(b) All metals do not have the same slip system. The reason for this is that for most metals, the slip system will consist of the most densely packed crystallographic plane, and within that plane the most closely packed direction. This plane and direction will vary from crystal structure to crystal structure.

7.6 (a) For the FCC crystal structure, the planar density for the (110) plane is given in Equation (3.12) as

$$PD_{110}(\text{FCC}) = \frac{1}{4R^2\sqrt{2}} = \frac{0.177}{R^2}$$

Furthermore, the planar densities of the (100) and (111) planes are calculated in Homework Problem 3.47, which are as follows:

$$PD_{100}(\text{FCC}) = \frac{1}{4R^2} = \frac{0.25}{R^2}$$

$$PD_{111}(\text{FCC}) = \frac{1}{2R^2\sqrt{3}} = \frac{0.29}{R^2}$$

(b) For the BCC crystal structure, the planar densities of the (100) and (110) planes were determined in Homework Problem 3.48, which are as follows:

$$PD_{100}(\text{BCC}) = \frac{3}{16R^2} = \frac{0.19}{R^2}$$

$$PD_{110}(\text{BCC}) = \frac{3}{8R^2\sqrt{2}} = \frac{0.27}{R^2}$$

Below is a BCC unit cell, within which is shown a (111) plane.

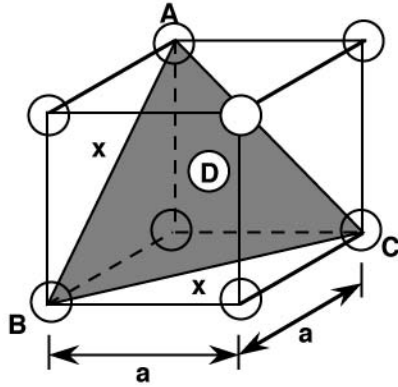

(a)

The centers of the three corner atoms, denoted by **A**, **B**, and **C** lie on this plane. Furthermore, the (111) plane does not pass through the center of atom **D**, which is located at the unit cell center. The atomic packing of this plane is presented in the following figure; the corresponding atom positions from the Figure (a) are also noted.

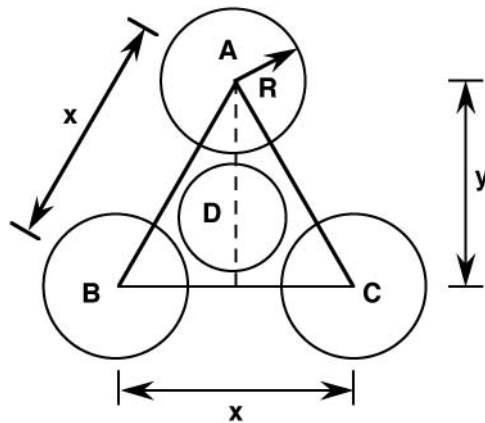

(b)

Inasmuch as this plane does not pass through the center of atom **D**, it is not included in the atom count. One sixth of each of the three atoms labeled **A**, **B**, and **C** is associated with this plane, which gives an equivalence of one-half atom.

In Figure (b) the triangle with **A**, **B**, and **C** at its corners is an equilateral triangle. And, from Figure (b), the area of this triangle is  $\frac{xy}{2}$ . The triangle edge length,  $x$ , is equal to the length of a face diagonal, as indicated in Figure (a). And its length is related to the unit cell edge length,  $a$ , as

$$x^2 = a^2 + a^2 = 2a^2$$



or

$$x = a\sqrt{2}$$

For BCC,  $a = \frac{4R}{\sqrt{3}}$ , and, therefore,

$$x = \frac{4R\sqrt{2}}{\sqrt{3}}$$

Also, with respect to the length  $y$  we may write

$$y^2 + \left(\frac{x}{2}\right)^2 = x^2$$

which leads to  $y = \frac{x\sqrt{3}}{2}$ . And, substitution for the above expression for  $x$  yields

$$y = \frac{x\sqrt{3}}{2} = \left(\frac{4R\sqrt{2}}{\sqrt{3}}\right)\left(\frac{\sqrt{3}}{2}\right) = \frac{4R\sqrt{2}}{2}$$

Thus, the area of this triangle is equal to

$$\text{AREA} = \frac{1}{2}xy = \left(\frac{1}{2}\right)\left(\frac{4R\sqrt{2}}{\sqrt{3}}\right)\left(\frac{4R\sqrt{2}}{2}\right) = \frac{8R^2}{\sqrt{3}}$$

And, finally, the planar density for this (111) plane is

$$\text{PD}_{111}(\text{BCC}) = \frac{0.5 \text{ atom}}{\frac{8R^2}{\sqrt{3}}} = \frac{\sqrt{3}}{16R^2} = \frac{0.11}{R^2}$$

7.7 Below is shown the atomic packing for a BCC {110} type plane. The arrows indicate two different  $\langle 111 \rangle$  type directions.

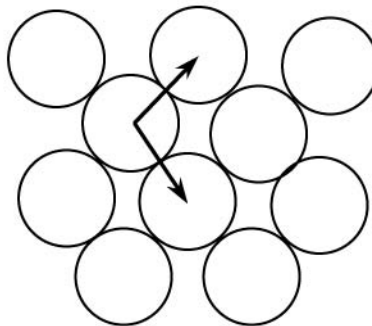

7.8 Below is shown the atomic packing for an HCP {0001} type plane. The arrows indicate three different  $\langle 11\bar{2}0 \rangle$  type directions.

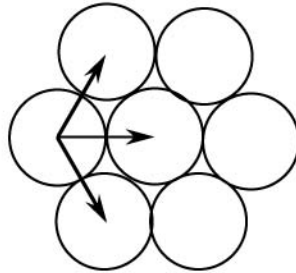

7.9 **Resolved shear stress** is the shear component of an applied tensile (or compressive) stress resolved along a slip plane that is other than perpendicular or parallel to the stress axis. **The critical resolved shear stress** is the value of resolved shear stress at which yielding begins; it is a property of the material.

7.10 We are asked to compute the **Schmid factor** for an FCC crystal oriented with its [100] direction parallel to the loading axis. With this scheme, slip may occur on the (111) plane and in the  $[1\bar{1}0]$  direction as noted in the figure below.

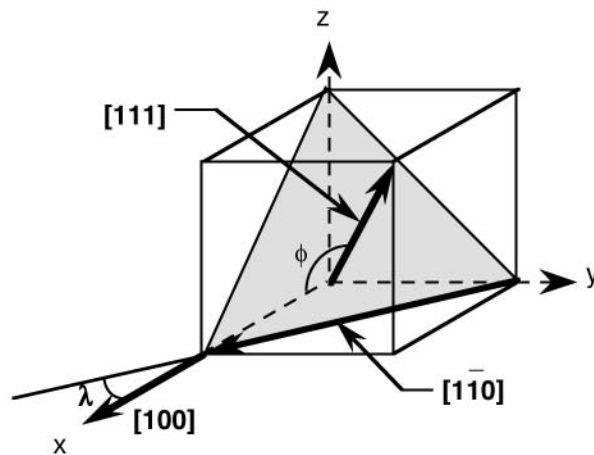

The angle between the [100] and  $[1\bar{1}0]$  directions,  $\lambda$ , is  $45^\circ$ . For the (111) plane, the angle between its normal (which is the [111] direction) and the [100] direction,  $\phi$ , is  $\tan^{-1} \left( \frac{a\sqrt{2}}{a} \right) = 54.74^\circ$ ,

therefore

$$\cos \lambda \cos \phi = \cos(45^\circ)\cos(54.74^\circ) = 0.408$$

7.11 This problem calls for us to determine whether or not a metal single crystal having a specific orientation and of given critical resolved shear stress will yield. We are given that  $\phi = 60^\circ$ ,  $\lambda = 35^\circ$ , and that the values of the critical resolved shear stress and applied tensile stress are 6.2 MPa (900 psi) and 12 MPa (1750 psi), respectively. From Equation (7.1)

$$\tau_R = \sigma \cos \phi \cos \lambda = (12 \text{ MPa})(\cos 60^\circ)(\cos 35^\circ) = 4.91 \text{ MPa} \quad (717 \text{ psi})$$

Since the resolved shear stress (4.91 MPa) is less than the critical resolved shear stress (6.2 MPa), the single crystal will not yield.

However, from Equation (7.3), the stress at which yielding occurs is

$$\sigma_Y = \frac{\tau_{\text{crss}}}{\cos \phi \cos \lambda} = \frac{6.2 \text{ MPa}}{(\cos 60^\circ)(\cos 35^\circ)} = 15.1 \text{ MPa} \quad (2200 \text{ psi})$$

7.12 We are asked to compute the critical resolved shear stress for Zn. As stipulated in the problem,  $\phi = 65^\circ$ , while possible values for  $\lambda$  are  $30^\circ$ ,  $48^\circ$ , and  $78^\circ$ .

(a) Slip will occur along that direction for which  $(\cos \phi \cos \lambda)$  is a maximum, or, in this case, for the largest  $\cos \lambda$ . The cosines for the possible  $\lambda$  values are given below.

$$\cos(30^\circ) = 0.87$$

$$\cos(48^\circ) = 0.67$$

$$\cos(78^\circ) = 0.21$$

Thus, the slip direction is at an angle of  $30^\circ$  with the tensile axis.

(b) From Equation (7.3), the critical resolved shear stress is just

$$\begin{aligned} \tau_{\text{crss}} &= \sigma_Y (\cos \phi \cos \lambda)_{\text{max}} \\ &= (2.5 \text{ MPa})[\cos(65^\circ)\cos(30^\circ)] = 0.90 \text{ MPa} \quad (130 \text{ psi}) \end{aligned}$$

7.13 This problem asks that we compute the critical resolved shear stress for silver. In order to do this, we must employ Equation (7.3), but first it is necessary to solve for the angles  $\lambda$  and  $\phi$  from the sketch below.

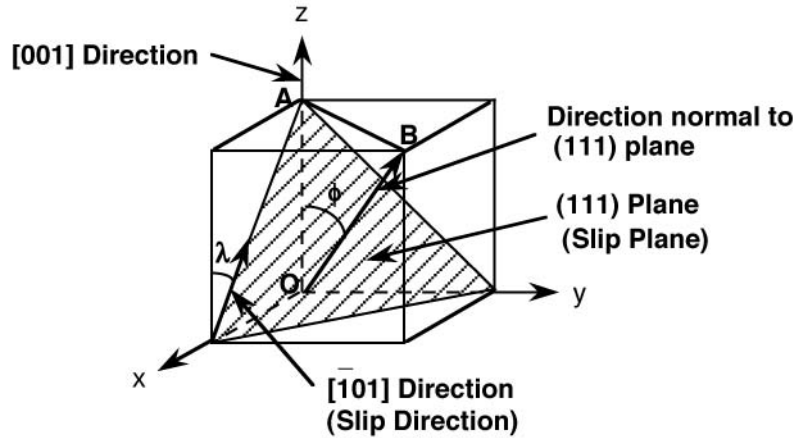

If the unit cell edge length is  $a$ , then

$$\lambda = \tan^{-1}\left(\frac{a}{a}\right) = 45^\circ$$

For the angle  $\phi$ , we must examine the triangle  $OAB$ . The length of line  $\overline{OA}$  is just  $a$ , whereas, the length of  $\overline{AB}$  is  $a\sqrt{2}$ . Thus,

$$\phi = \tan^{-1}\left(\frac{a\sqrt{2}}{a}\right) = 54.7^\circ$$

And, finally

$$\begin{aligned} \tau_{\text{crss}} &= \sigma_y (\cos \phi \cos \lambda) \\ &= (1.1 \text{ MPa}) [\cos(54.7^\circ) \cos(45^\circ)] = 0.45 \text{ MPa} \quad (65.4 \text{ psi}) \end{aligned}$$

7.14 This problem asks that, for a metal that has the FCC crystal structure, we compute the applied stress(s) that are required to cause slip to occur on a (111) plane in each of the  $[1\bar{1}0]$ ,  $[10\bar{1}]$ , and  $[0\bar{1}1]$  directions. In order to solve this problem it is necessary to employ Equation (7.3), which means that we will need to solve for the for angles  $\lambda$  and  $\phi$  for the three slip systems.

In the sketch below is shown the unit cell and (111)- $[1\bar{1}0]$  slip configuration.

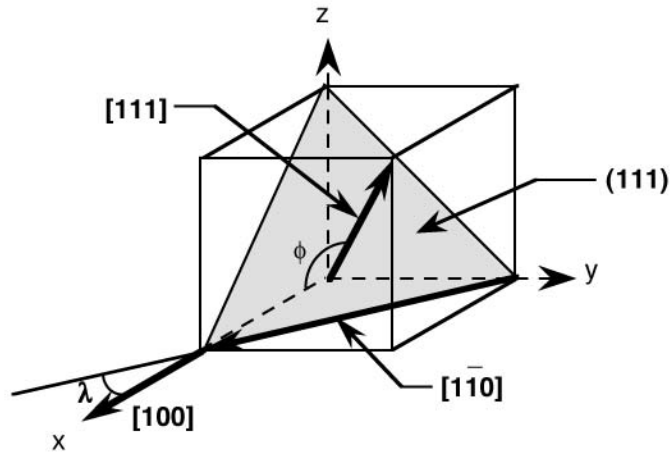

The angle between the [100] and  $[1\bar{1}0]$  directions,  $\lambda$ , is  $45^\circ$ . For the (111) plane, the angle between its normal (which is the [111] direction) and the [100] direction,  $\phi$ , is  $\tan^{-1}\left(\frac{a\sqrt{2}}{a}\right) = 54.7^\circ$ , therefore, solving for the yield strength from Equation (7.3)

$$\sigma_y = \frac{\tau_{crss}}{(\cos\phi \cos\lambda)}$$

$$= \frac{0.5 \text{ MPa}}{\cos(54.7^\circ) \cos(45^\circ)} = \frac{0.5 \text{ MPa}}{(0.578)(0.707)} = 1.22 \text{ MPa}$$

The (111)-  $[10\bar{1}]$  slip configuration is represented in the following sketch.

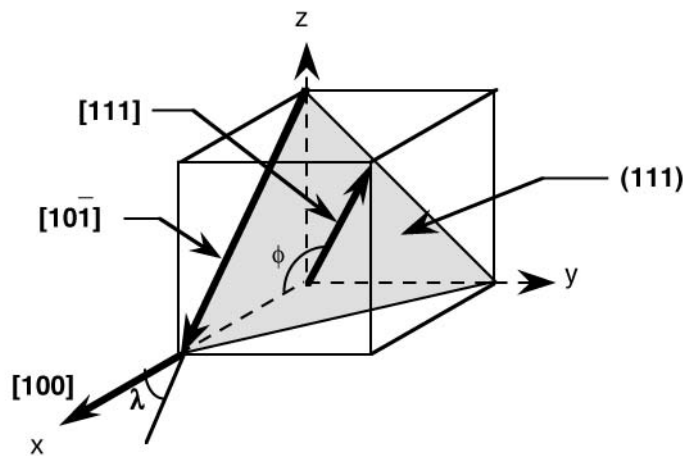

For this situation values for  $\lambda$  and  $\phi$  are the same as for the previous situation—i.e.,  $\lambda = 45^\circ$  and  $\phi = 54.7^\circ$ . This means that the yield strength for this slip system is the same as for (111)- $[\bar{1}\bar{1}0]$ ; that is  $\sigma_y = 1.22$  MPa.

The unit cell and final (111)- $[0\bar{1}1]$  slip system are presented in the following illustration.

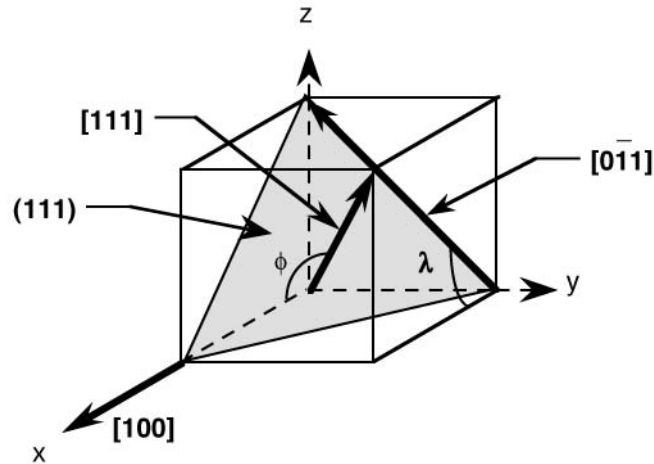

In this case,  $\phi$  has the same value as previously (i.e.,  $54.7^\circ$ ); however the value for  $\lambda$  is  $90^\circ$ . Thus, the yield strength for this configuration is

$$\sigma_y = \frac{\tau_{crss}}{(\cos \phi \cos \lambda)}$$

$$= \frac{0.5 \text{ MPa}}{\cos(54.7^\circ) \cos(90^\circ)} = \frac{0.5 \text{ MPa}}{(0.578)(0)} = \infty$$

which means that slip will not occur on this (111)- $[0\bar{1}1]$  slip system.

7.15 This problem asks, for a BCC metal, that we compute the applied stress(s) that are required to cause slip to occur in the  $[\bar{1}\bar{1}1]$  direction on each of the (110), (011), and  $(10\bar{1})$  planes. In order to solve this problem it is necessary to employ Equation (7.3), which means that we need to solve for the for angles  $\lambda$  and  $\phi$  for the three slip systems.

In the sketch below is shown the unit cell and the (110)- $[\bar{1}\bar{1}1]$  slip configuration.

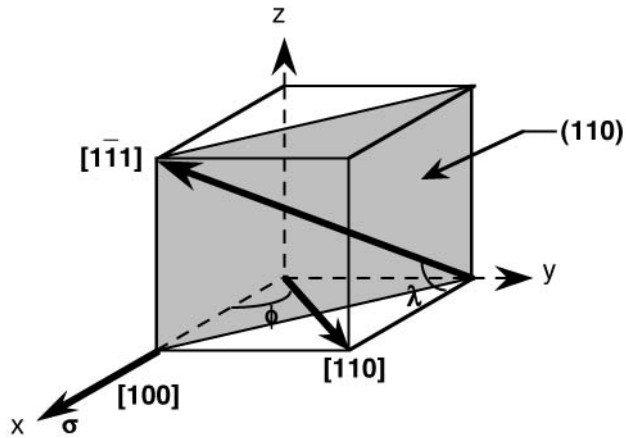

The angle  $\phi$  between the  $[1\bar{1}1]$  slip direction and the normal to the (110) plane (i.e., the  $[110]$  direction) is  $45^\circ$ . Now, in order to determine the angle between the  $[1\bar{1}1]$  direction and the  $[100]$  direction (i.e., the direction of stress application),  $\lambda$ , we consult the illustration of this same unit cell as shown below.

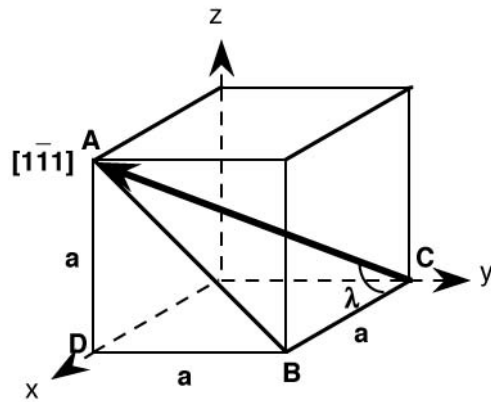

For the triangle **ABC**, the angle  $\lambda$  is equal to  $\tan^{-1}\left(\frac{\overline{AB}}{\overline{BC}}\right)$ . The length  $\overline{BC}$  is equal to the unit cell edge length **a**. From triangle **ABD**,  $\overline{AB} = a\sqrt{2}$ , and, therefore,  $\lambda = \left(\frac{a\sqrt{2}}{a}\right) = 54.7^\circ$ . And, solving for the resolved shear stress from Equation (7.1)

$$\tau_R = \sigma \cos \phi \cos \lambda$$

$$= (4.0 \text{ MPa})[\cos(45^\circ)\cos(54.7^\circ)] = (4.0 \text{ MPa})(0.707)(0.578) = 1.63 \text{ MPa}$$

The (011)- $[1\bar{1}1]$  slip configuration is represented in the following sketch.

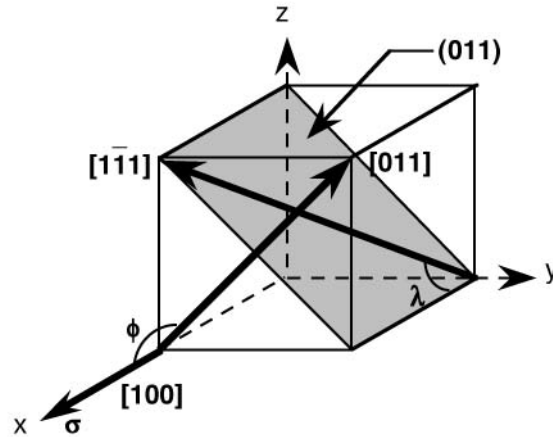

In this case,  $\lambda$  has the same value as previously (i.e.,  $54.7^\circ$ ); however the value for  $\phi$  is  $90^\circ$ . Thus, the resolved shear stress for this configuration is

$$\tau_R = \sigma \cos \phi \cos \lambda$$

$$= (4.0 \text{ MPa})[\cos(90^\circ)\cos(54.7^\circ)] = (4.0 \text{ MPa})(0)(0.578) = 0 \text{ MPa}$$

And, finally the  $(10\bar{1})$ - $[\bar{1}\bar{1}1]$  slip configuration is shown below.

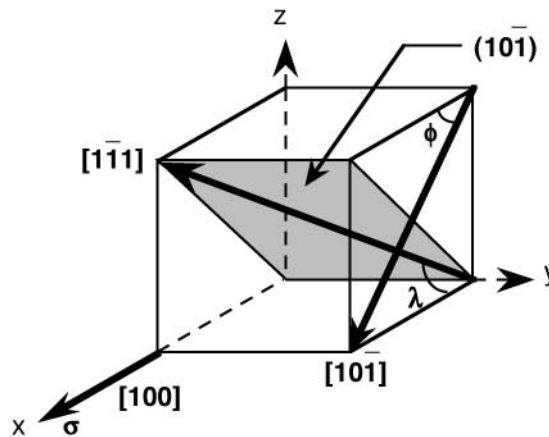

Here, the value of  $\phi$  is  $45^\circ$ , which again leads to

$$\tau_R = \sigma \cos \phi \cos \lambda$$

$$= (4.0 \text{ MPa})[\cos(45^\circ)\cos(54.7^\circ)] = (4.0 \text{ MPa})(0.707)(0.578) = 1.63 \text{ MPa}$$



(b) The most favored slip system(s) is (are) the one(s) that has (have) the largest  $\tau_R$  value. Both (110)-[1 $\bar{1}$ 1] and (10 $\bar{1}$ )-[1 $\bar{1}$ 1] slip systems are most favored since they have the same  $\tau_R$  (1.63 MPa), which is larger than the  $\tau_R$  value for (011)-[1 $\bar{1}$ 1] (viz., 0 MPa).

7.16 In order to determine the maximum possible yield strength for a single crystal of Cu pulled in tension, we simply employ Equation (7.4) as

$$\sigma_y = 2\tau_{\text{crss}} = (2)(0.48 \text{ MPa}) = 0.96 \text{ MPa} \quad (140 \text{ psi})$$

7.17W Four major differences between deformation by twinning and deformation by slip are as follows:

1) with slip deformation there is no crystallographic reorientation, whereas with twinning there is a reorientation; 2) for slip, the atomic displacements occur in atomic spacing multiples, whereas for twinning, these displacements may be other than by atomic spacing multiples; 3) slip occurs in metals having many slip systems, whereas twinning occurs in metals having relatively few slip systems; and 4) normally slip results in relatively large deformations, whereas only small deformations result for twinning.

7.18 Small-angle grain boundaries are not as effective in interfering with the slip process as are high-angle grain boundaries because there is not as much crystallographic misalignment in the grain boundary region for small-angle, and therefore not as much change in slip direction.

7.19 Hexagonal close packed metals are typically more brittle than FCC and BCC metals because there are fewer slip systems in HCP.

7.20 These three strengthening mechanisms are described in Sections 7.8, 7.9, and 7.10.

7.21 (a) Perhaps the easiest way to solve for  $\sigma_o$  and  $k_y$  in Equation (7.5) is to pick two values each of  $\sigma_y$  and  $d^{-1/2}$  from Figure 7.13, and then set up and solve two simultaneous equations. For example

$d^{-1/2} \text{ (mm)}^{-1/2}$	$\sigma_y \text{ (MPa)}$
4	75
12	175

The two equations are thus

$$75 = \sigma_o + 4k_y$$

$$175 = \sigma_o + 12k_y$$

These yield the values of

$$k_y = 12.5 \text{ MPa}(\text{mm})^{1/2} \left[ 1810 \text{ psi}(\text{mm})^{1/2} \right]$$

$$\sigma_o = 25 \text{ MPa} \quad (3630 \text{ psi})$$

(b) When  $d = 1.0 \times 10^{-3} \text{ mm}$ ,  $d^{-1/2} = 31.6 \text{ mm}^{-1/2}$ , and, using Equation (7.5),

$$\begin{aligned} \sigma_y &= \sigma_o + k_y d^{-1/2} \\ &= (25 \text{ MPa}) + \left[ 12.5 \text{ MPa}(\text{mm})^{1/2} \right] (31.6 \text{ mm}^{-1/2}) = 420 \text{ MPa} \quad (61,000 \text{ psi}) \end{aligned}$$

7.22 We are asked to determine the grain diameter for an iron which will give a yield strength of 205 MPa (30,000 psi). The best way to solve this problem is to first establish two simultaneous expressions of Equation (7.5), solve for  $\sigma_o$  and  $k_y$ , and finally determine the value of  $d$  when  $\sigma_y = 205 \text{ MPa}$ . The data pertaining to this problem may be tabulated as follows:

$\sigma_y$	$d$ (mm)	$d^{-1/2}$ (mm) <sup>-1/2</sup>
135 MPa	$5 \times 10^{-2}$	4.47
260 MPa	$8 \times 10^{-3}$	11.18

The two equations thus become

$$\begin{aligned} 135 \text{ MPa} &= \sigma_o + (4.47)k_y \\ 260 \text{ MPa} &= \sigma_o + (11.18)k_y \end{aligned}$$

Which yield the values,  $\sigma_o = 51.7 \text{ MPa}$  and  $k_y = 18.63 \text{ MPa}(\text{mm})^{1/2}$ . At a yield strength of 205 MPa

$$205 \text{ MPa} = 51.7 \text{ MPa} + \left[ 18.63 \text{ MPa}(\text{mm})^{1/2} \right] d^{-1/2}$$

or  $d^{-1/2} = 8.23 \text{ (mm)}^{-1/2}$ , which gives  $d = 1.48 \times 10^{-2} \text{ mm}$ .

7.23 This problem asks that we determine the grain size of the brass which is the subject of Figure 7.17. From Figure 7.17(a), the yield strength of brass at 0%CW is approximately 175 MPa (26,000 psi). This yield strength from Figure 7.13 corresponds to a  $d^{-1/2}$  value of approximately  $12.0 \text{ (mm)}^{-1/2}$ . Thus,  $d = 6.9 \times 10^{-3} \text{ mm}$ .

7.24 Below is shown an edge dislocation and the location where an interstitial impurity atom would be situated. Compressive lattice strains are introduced by the impurity atom. There will be a net reduction in lattice strain energy when these lattice strains partially cancel tensile strains associated with the edge dislocation; such tensile strains exist just below the bottom of the extra half-plane of atoms (Figure 7.4).

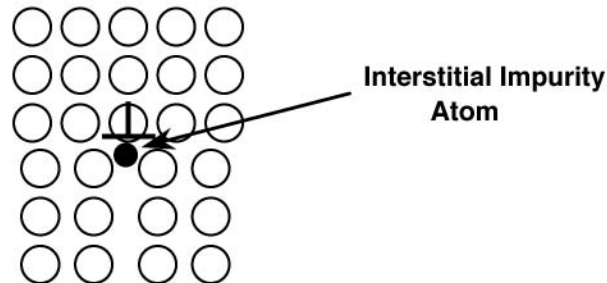

7.25 The hardness measured from an indentation that is positioned very close to a preexisting indentation will be high. The material in this vicinity was cold-worked when the first indentation was made.

7.26 (a) We are asked to show, for a tensile test, that

$$\%CW = \left( \frac{\epsilon}{\epsilon + 1} \right) \times 100$$

From Equation (7.6)

$$\%CW = \left[ \frac{A_o - A_d}{A_o} \right] \times 100 = \left[ 1 - \frac{A_d}{A_o} \right] \times 100$$

Which is also equal to

$$\left[ 1 - \frac{l_o}{l_d} \right] \times 100$$

since  $A_d/A_o = l_o/l_d$ , the conservation of volume stipulation in the problem. Now, from the definition of engineering strain [Equation (6.2)]

$$\varepsilon = \frac{l_d - l_o}{l_o} = \frac{l_d}{l_o} - 1$$

Or,

$$\frac{l_o}{l_d} = \frac{1}{\varepsilon + 1}$$

Substitution in the **%CW** expression above gives

$$\%CW = \left[ 1 - \frac{l_o}{l_d} \right] \times 100 = \left[ 1 - \frac{1}{\varepsilon + 1} \right] \times 100 = \left[ \frac{\varepsilon}{\varepsilon + 1} \right] \times 100$$

(b) From Figure 6.12, a stress of 415 MPa (60,000 psi) corresponds to a strain of 0.16. Using the above expression

$$\%CW = \left[ \frac{\varepsilon}{\varepsilon + 1} \right] \times 100 = \left[ \frac{0.16}{0.16 + 1.00} \right] \times 100 = 13.8\%CW$$

7.27 In order for these two cylindrical specimens to have the same deformed hardness, they must be deformed to the same percent cold work. For the first specimen

$$\begin{aligned} \%CW &= \frac{A_o - A_d}{A_o} \times 100 = \frac{\pi r_o^2 - \pi r_d^2}{\pi r_o^2} \times 100 \\ &= \frac{\pi (15 \text{ mm})^2 - \pi (12 \text{ mm})^2}{\pi (15 \text{ mm})^2} \times 100 = 36\%CW \end{aligned}$$

For the second specimen, the deformed radius is computed using the above equation and solving for  $r_d$  as

$$r_d = r_o \sqrt{1 - \frac{\%CW}{100}}$$

$$= (11 \text{ mm}) \sqrt{1 - \frac{36\%CW}{100}} = 8.80 \text{ mm}$$

7.28 We are given the original and deformed cross-sectional dimensions for two specimens of the same metal, and are then asked to determine which is the hardest after deformation. The hardest specimen will be the one that has experienced the greatest degree of cold work. Therefore, all we need do is to compute the %CW for each specimen using Equation (7.6). For the circular one

$$\%CW = \left[ \frac{A_o - A_d}{A_o} \right] \times 100$$

$$= \left[ \frac{\pi \left( \frac{15.2 \text{ mm}}{2} \right)^2 - \pi \left( \frac{11.4 \text{ mm}}{2} \right)^2}{\pi \left( \frac{15.2 \text{ mm}}{2} \right)^2} \right] \times 100 = 43.8\%CW$$

For the rectangular one

$$\%CW = \left[ \frac{(125 \text{ mm})(175 \text{ mm}) - (75 \text{ mm})(200 \text{ mm})}{(125 \text{ mm})(175 \text{ mm})} \right] \times 100 = 31.4\%CW$$

Therefore, the deformed circular specimen will be harder.

7.29 This problem calls for us to calculate the precold-worked radius of a cylindrical specimen of copper that has a cold-worked ductility of 25%EL. From Figure 7.17(c), copper that has a ductility of 25%EL will have experienced a deformation of about 11%CW. For a cylindrical specimen, Equation (7.6) becomes

$$\%CW = \left[ \frac{\pi r_o^2 - \pi r_d^2}{\pi r_o^2} \right] \times 100$$

Since  $r_d = 10 \text{ mm}$  (0.40 in.), solving for  $r_o$  yields

$$r_o = \frac{r_d}{\sqrt{1 - \frac{\%CW}{100}}} = \frac{10 \text{ mm}}{\sqrt{1 - \frac{11.0}{100}}} = 10.6 \text{ mm} \quad (0.424 \text{ in.})$$

7.30 (a) We want to compute the ductility of a brass that has a yield strength of 275 MPa (40,000 psi). In order to solve this problem, it is necessary to consult Figures 7.17(a) and (c). From Figure 7.17(a), a yield strength of 275 MPa for brass corresponds to 10%CW. A brass that has been cold-worked 10% will have a ductility of about 44%EL [Figure 7.17(c)].

(b) This portion of the problem asks for the Brinell hardness of a 1040 steel having a yield strength of 690 MPa (100,000 psi). From Figure 7.17(a), a yield strength of 690 MPa for a 1040 steel corresponds to about 11%CW. A 1040 steel that has been cold worked 11% will have a tensile strength of about 790 MPa [Figure 7.17(b)]. Finally, using Equation (6.20a)

$$HB = \frac{TS \text{ (MPa)}}{3.45} = \frac{790 \text{ MPa}}{3.45} = 230$$

7.31 We are asked in this problem to compute the critical resolved shear stress at a dislocation density of  $10^6 \text{ mm}^{-2}$ . It is first necessary to compute the value of the constant **A** from the one set of data as

$$A = \frac{\tau_{crss} - \tau_o}{\sqrt{\rho_D}} = \frac{0.69 \text{ MPa} - 0.069 \text{ MPa}}{\sqrt{10^4 \text{ mm}^{-2}}} = 6.21 \times 10^{-3} \text{ MPa} - \text{mm} \quad (0.90 \text{ psi} - \text{mm})$$

Now, the critical resolved shear stress may be determined at a dislocation density of  $10^6 \text{ mm}^{-2}$  as

$$\begin{aligned} \tau_{crss} &= \tau_o + A\sqrt{\rho_D} \\ &= (0.069 \text{ MPa}) + (6.21 \times 10^{-3} \text{ MPa} - \text{mm})\sqrt{10^6 \text{ mm}^{-2}} = 6.28 \text{ MPa} \quad (910 \text{ psi}) \end{aligned}$$

7.32 For recovery, there is some relief of internal strain energy by dislocation motion; however, there are virtually no changes in either the grain structure or mechanical characteristics. During recrystallization, on the other hand, a new set of strain-free grains forms, and the material becomes softer and more ductile.

7.33 We are asked to estimate the fraction of recrystallization from the photomicrograph in Figure 7.19c. Below is shown a square grid onto which is superimposed the recrystallized regions from the

micrograph. Approximately 400 squares lie within the recrystallized areas, and since there are 672 total squares, the specimen is about 60% recrystallized.

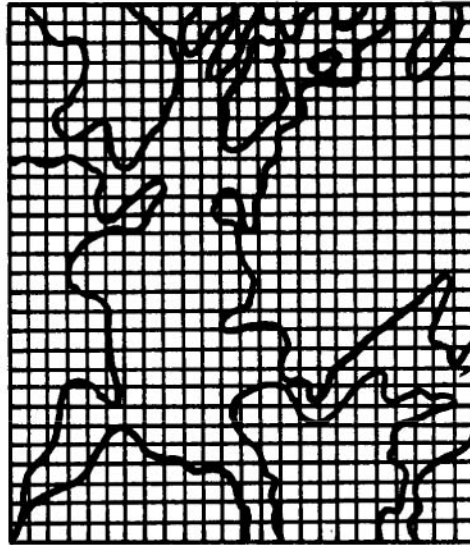

- 7.34 During cold-working, the grain structure of the metal has been distorted to accommodate the deformation. Recrystallization produces grains that are equiaxed and smaller than the parent grains.
- 7.35 Metals such as lead and tin do not strain harden at room temperature because their recrystallization temperatures lie below room temperature (Table 7.2).
- 7.36 (a) The driving force for recrystallization is the difference in internal energy between the strained and unstrained material.  
(b) The driving force for grain growth is the reduction in grain boundary energy as the total grain boundary area decreases.
- 7.37 In this problem, we are asked for the length of time required for the average grain size of a brass material to increase a specified amount using Figure 7.23.  
(a) At 500°C, the time necessary for the average grain diameter to increase from 0.01 to 0.1 mm is approximately 3500 min.  
(b) At 600°C the time required for this same grain size increase is approximately 150 min.
- 7.38 (a) Using the data given and Equation (7.7) and taking  $n = 2$ , we may set up two simultaneous equations with  $d_0$  and  $K$  as unknowns; thus

$$\left(3.9 \times 10^{-2} \text{ mm}\right)^2 - d_0^2 = (30 \text{ min})K$$

$$\left(6.6 \times 10^{-2} \text{ mm}\right)^2 - d_0^2 = (90 \text{ min})K$$

Solution of these expressions yields a value for  $d_0$ , the original grain diameter, of

$$d_0 = 0.01 \text{ mm,}$$

Also

$$K = 4.73 \times 10^{-5} \text{ mm}^2/\text{min}$$

(b) At 150 min, the diameter is computed as

$$d = \sqrt{d_0^2 + Kt}$$

$$= \sqrt{(0.01 \text{ mm})^2 + (4.73 \times 10^{-5} \text{ mm}^2/\text{min})(150 \text{ min})} = 0.085 \text{ mm}$$

7.39 Yes, it is possible to reduce the average grain diameter of an undeformed alloy specimen from 0.050 mm to 0.020 mm. In order to do this, plastically deform the material at room temperature (i.e., cold work it), and then anneal it at an elevated temperature in order to allow recrystallization and some grain growth to occur until the average grain diameter is 0.020 mm.

7.40 (a) The temperature dependence of grain growth is incorporated into the constant  $K$  in Equation (7.7).

(b) The explicit expression for this temperature dependence is of the form

$$K = K_0 \exp\left(-\frac{Q}{RT}\right)$$

in which  $K_0$  is a temperature-independent constant, the parameter  $Q$  is an activation energy, and  $R$  and  $T$  are the gas constant and absolute temperature, respectively.

7.41 This problem calls for us to calculate the yield strength of a brass specimen after it has been heated to an elevated temperature at which grain growth was allowed to occur; the yield strength was given at a grain size of 0.01 mm. It is first necessary to calculate the constant  $k_y$  in Equation (7.5) as



$$k_y = \frac{\sigma_y - \sigma_o}{d^{-1/2}}$$

$$= \frac{150 \text{ MPa} - 25 \text{ MPa}}{(0.01 \text{ mm})^{-1/2}} = 12.5 \text{ MPa} \cdot \text{mm}^{1/2}$$

Next, we must determine the average grain size after the heat treatment. From Figure 7.23 at 500°C after 1000 s (16.7 min) the average grain size of a brass material is about 0.016 mm. Therefore, calculating  $\sigma_y$  at this new grain size using Equation (7.5) we get

$$\sigma_y = \sigma_o + k_y d^{-1/2}$$

$$= 25 \text{ MPa} + \left(12.5 \text{ MPa} \cdot \text{mm}^{1/2}\right)(0.016 \text{ mm})^{-1/2} = 124 \text{ MPa} \text{ (18,000 psi)}$$

### Design Problems

7.D1 This problem calls for us to determine whether or not it is possible to cold work steel so as to give a minimum Brinell hardness of 240 and a ductility of at least 15%EL. According to Figure 6.19, a Brinell hardness of 240 corresponds to a tensile strength of 800 MPa (116,000 psi). Furthermore, from Figure 7.17(b), in order to achieve a tensile strength of 800 MPa, deformation of at least 13%CW is necessary. Finally, if we cold work the steel to 13%CW, then the ductility is 15%EL from Figure 7.17(c). Therefore, it is **possible** to meet both of these criteria by plastically deforming the steel.

7.D2 We are asked to determine whether or not it is possible to cold work brass so as to give a minimum Brinell hardness of 150 and at the same time a ductility of at least 20%EL. According to Figure 6.19, a Brinell hardness of 150 corresponds to a tensile strength of 500 MPa (72,000 psi.) Furthermore, from Figure 7.17(b), in order to achieve a tensile strength of 500 MPa, deformation of at least 36%CW is necessary. Finally, if we are to achieve a ductility of at least 20%EL, then a maximum deformation of 23%CW is possible from Figure 7.17(c). Therefore, it is **not possible** to meet both of these criteria by plastically deforming brass.

7.D3 (a) For this portion of the problem we are to determine the ductility of cold-worked steel that has a Brinell hardness of 240. From Figure 6.19, a Brinell hardness of 240 corresponds to a tensile

strength of 820 MPa (120,000 psi), which, from Figure 7.17(b), requires a deformation of 17%CW. Furthermore, 17%CW yields a ductility of about 13%EL for steel, Figure 7.17(c).

(b) We are now asked to determine the radius after deformation if the uncold-worked radius is 10 mm (0.40 in.). From Equation (7.6) and for a cylindrical specimen

$$\%CW = \left[ \frac{\pi r_o^2 - \pi r_d^2}{\pi r_o^2} \right] \times 100$$

Now, solving for  $r_d$  from this expression, we get

$$r_d = r_o \sqrt{1 - \frac{\%CW}{100}}$$

$$= (10 \text{ mm}) \sqrt{1 - \frac{17}{100}} = 9.11 \text{ mm} \quad (0.364 \text{ in.})$$

7.D4 This problem asks us to determine which of copper, brass, and a 1040 steel may be cold-worked so as to achieve a minimum yield strength of 345 MPa (50,000 psi) while maintaining a minimum ductility of 20%EL. For each of these alloys, the minimum cold work necessary to achieve the yield strength may be determined from Figure 7.17(a), while the maximum possible cold work for the ductility is found in Figure 7.17(c). These data are tabulated below.

	Yield Strength ( <u>&gt; 345 MPa</u> )	Ductility ( <u>&gt; 20%EL</u> )
Steel	Any %CW	< 5%CW
Brass	> 20%CW	< 23%CW
Copper	> 54%CW	< 15%CW

Thus, both the 1040 steel and brass are possible candidates since for these alloys there is an overlap of percents coldwork to give the required minimum yield strength and ductility values.

7.D5 This problem calls for us to explain the procedure by which a cylindrical rod of steel may be deformed so as to produce a given final diameter, as well as a specific tensile strength and ductility. First let us calculate the percent cold work and attendant tensile strength and ductility if the drawing is carried out without interruption. From Equation (7.6)

$$\%CW = \frac{\pi \left(\frac{d_o}{2}\right)^2 - \pi \left(\frac{d_d}{2}\right)^2}{\pi \left(\frac{d_o}{2}\right)^2} \times 100$$

$$= \frac{\pi \left(\frac{15.2 \text{ mm}}{2}\right)^2 - \pi \left(\frac{10 \text{ mm}}{2}\right)^2}{\pi \left(\frac{15.2 \text{ mm}}{2}\right)^2} \times 100 = 56\%CW$$

At 56%CW, the steel will have a tensile strength on the order of 920 MPa (133,000 psi) [Figure 7.17(b)], which is adequate; however, the ductility will be less than 10%EL [Figure 7.17(c)], which is insufficient.

Instead of performing the drawing in a single operation, let us initially draw some fraction of the total deformation, then anneal to recrystallize, and, finally, cold-work the material a second time in order to achieve the final diameter, tensile strength, and ductility.

Reference to Figure 7.17(b) indicates that 20%CW is necessary to yield a tensile strength of 840 MPa (122,000 psi). Similarly, a maximum of 21%CW is possible for 12%EL [Figure 7.17(c)]. The average of these extremes is 20.5%CW. If the final diameter after the first drawing is  $d'_o$ , then

$$20.5\%CW = \frac{\pi \left(\frac{d'_o}{2}\right)^2 - \pi \left(\frac{10 \text{ mm}}{2}\right)^2}{\pi \left(\frac{d'_o}{2}\right)^2} \times 100$$

And, solving for  $d'_o$ , yields  $d'_o = 11.2 \text{ mm}$  (0.45 in.).

7.D6 Let us first calculate the percent cold work and attendant yield strength and ductility if the drawing is carried out without interruption. From Equation (7.6)

$$\%CW = \frac{\pi \left(\frac{d_o}{2}\right)^2 - \pi \left(\frac{d_d}{2}\right)^2}{\pi \left(\frac{d_o}{2}\right)^2} \times 100$$

$$= \frac{\pi \left( \frac{10.2 \text{ mm}}{2} \right)^2 - \pi \left( \frac{7.6 \text{ mm}}{2} \right)^2}{\pi \left( \frac{10.2 \text{ mm}}{2} \right)^2} \times 100 = 44.5\% \text{CW}$$

At 44.5%CW, the brass will have a yield strength on the order of 420 MPa (61,000 psi), Figure 7.17(a), which is adequate; however, the ductility will be about 5%EL, Figure 7.17(c), which is insufficient.

Instead of performing the drawing in a single operation, let us initially draw some fraction of the total deformation, then anneal to recrystallize, and, finally, cold work the material a second time in order to achieve the final diameter, yield strength, and ductility.

Reference to Figure 7.17(a) indicates that 26%CW is necessary to give a yield strength of 380 MPa. Similarly, a maximum of 27.5%CW is possible for 15%EL [Figure 7.17(c)]. The average of these two values is 26.8%CW, which we will use in the calculations. If the final diameter after the first drawing is  $d'_o$ , then

$$26.8\% \text{CW} = \frac{\pi \left( \frac{d'_o}{2} \right)^2 - \pi \left( \frac{7.6 \text{ mm}}{2} \right)^2}{\pi \left( \frac{d'_o}{2} \right)^2} \times 100$$

And, solving for  $d'_o$  yields  $d'_o = 9.4 \text{ mm}$  (0.37 in.).

7.D7 This problem calls for us to cold work some brass stock that has been previously cold worked in order to achieve minimum tensile strength and ductility values of 450 MPa (65,000 psi) and 13%EL, respectively, while the final diameter must be 12.7 mm (0.50 in.). Furthermore, the material may not be deformed beyond 65%CW. Let us start by deciding what percent coldwork is necessary for the minimum tensile strength and ductility values, assuming that a recrystallization heat treatment is possible. From Figure 7.17(b), at least 27%CW is required for a tensile strength of 450 MPa. Furthermore, according to Figure 7.17(c), 13%EL corresponds a maximum of 30%CW. Let us take the average of these two values (i.e., 28.5%CW), and determine what previous specimen diameter is required to yield a final diameter of 12.7 mm. For cylindrical specimens, Equation (7.6) takes the form

$$\%CW = \frac{\pi \left(\frac{d_o}{2}\right)^2 - \pi \left(\frac{d_d}{2}\right)^2}{\pi \left(\frac{d_o}{2}\right)^2} \times 100$$

Solving for the original diameter  $d_o$  yields

$$d_o = \frac{d_d}{\sqrt{1 - \frac{\%CW}{100}}} = \frac{12.7 \text{ mm}}{\sqrt{1 - 0.285}} = 15.0 \text{ mm} \quad (0.591 \text{ in.})$$

Now, let us determine its undeformed diameter realizing that a diameter of 19.0 mm corresponds to 35%CW. Again solving for  $d_o$  using the above equation and assuming  $d_d = 19.0$  mm yields

$$d_o = \frac{d_d}{\sqrt{1 - \frac{\%CW}{100}}} = \frac{19.0 \text{ mm}}{\sqrt{1 - 0.35}} = 23.6 \text{ mm} \quad (0.930 \text{ in.})$$

At this point let us see if it is possible to deform the material from 23.6 mm to 15.0 mm without exceeding the 65%CW limit. Again employing Equation (7.6)

$$\%CW = \frac{\pi \left(\frac{23.6 \text{ mm}}{2}\right)^2 - \pi \left(\frac{15.0 \text{ mm}}{2}\right)^2}{\pi \left(\frac{23.6 \text{ mm}}{2}\right)^2} \times 100 = 59.6\%CW$$

In summary, the procedure which can be used to produce the desired material would be as follows: cold work the as-received stock to 15.0 mm (0.591 in.), heat treat it to achieve complete recrystallization, and then cold work the material again to 12.7 mm (0.50 in.), which will give the desired tensile strength and ductility.

## CHAPTER 8

### FAILURE

#### PROBLEM SOLUTIONS

8.1 Several situations in which the possibility of failure is part of the design of a component or product are as follows: (1) the pull tab on the top of aluminum beverage cans; (2) aluminum utility/light poles that reside along freeways--a minimum of damage occurs to a vehicle when it collides with the pole; and (3) in some machinery components, shear pin are used to connect a gear or pulley to a shaft--the pin is designed shear off before damage is done to either the shaft or gear in an overload situation.

8.2W The theoretical cohesive strength of a material is just  $E/10$ , where  $E$  is the modulus of elasticity. For the ceramic materials listed in Table 12.5, all we need do is divide  $E$  by 10, and therefore

$$\text{Si}_3\text{N}_4\text{--}30.4 \text{ GPa } (4.4 \times 10^6 \text{ psi})$$

$$\text{ZrO}_2\text{--}20.5 \text{ GPa } (3.0 \times 10^6 \text{ psi})$$

$$\text{SiC--}34.5 \text{ GPa } (5.0 \times 10^6 \text{ psi})$$

$$\text{Al}_2\text{O}_3\text{--}39.3 \text{ GPa } (5.7 \times 10^6 \text{ psi})$$

$$\text{Glass ceramic--}12.0 \text{ GPa } (1.7 \times 10^6 \text{ psi})$$

$$\text{Mullite--}14.5 \text{ GPa } (2.1 \times 10^6 \text{ psi})$$

$$\text{MgAl}_2\text{O}_4\text{--}26 \text{ GPa } (3.8 \times 10^6 \text{ psi})$$

$$\text{MgO--}22.5 \text{ GPa } (3.3 \times 10^6 \text{ psi})$$

$$\text{Fused silica--}7.3 \text{ GPa } (1.1 \times 10^6 \text{ psi})$$

$$\text{Soda-lime glass--}6.9 \text{ GPa } (1.0 \times 10^6 \text{ psi})$$

8.3 This problem asks that we compute the magnitude of the maximum stress that exists at the tip of an internal crack. Equation (8.1) is employed to solve this problem, as

$$\sigma_m = 2\sigma_o \left( \frac{a}{\rho_t} \right)^{1/2}$$

$$= (2)(170 \text{ MPa}) \left[ \frac{2.5 \times 10^{-2} \text{ mm}}{2.5 \times 10^{-4} \text{ mm}} \right]^{1/2} = 2404 \text{ MPa} \quad (354,000 \text{ psi})$$

8.4 In order to estimate the theoretical fracture strength of this material it is necessary to calculate  $\sigma_m$  using Equation (8.1) given that  $\sigma_o = 1035 \text{ MPa}$ ,  $a = 0.5 \text{ mm}$ , and  $\rho_t = 5 \times 10^{-3} \text{ mm}$ . Thus,

$$\begin{aligned} \sigma_m &= 2\sigma_o \sqrt{\frac{a}{\rho_t}} \\ &= (2)(1035 \text{ MPa}) \sqrt{\frac{0.5 \text{ mm}}{5 \times 10^{-3} \text{ mm}}} = 2.07 \times 10^4 \text{ MPa} = 207 \text{ GPa} \quad (3 \times 10^6 \text{ psi}) \end{aligned}$$

8.5 In order to determine whether or not this ceramic material will fail we must compute its theoretical fracture (or cohesive) strength; if the maximum strength at the tip of the most severe flaw is greater than this value then fracture will occur--if less than, then there will be no fracture. The theoretical fracture strength is just  $E/10$  or  $25 \text{ GPa}$  ( $3.63 \times 10^6 \text{ psi}$ ), inasmuch as  $E = 250 \text{ GPa}$  ( $36.3 \times 10^6 \text{ psi}$ ).

The magnitude of the stress at the most severe flaw may be determined using Equation (8.1) as

$$\begin{aligned} \sigma_m &= 2\sigma_o \sqrt{\frac{a}{\rho_t}} \\ &= (2)(750 \text{ MPa}) \sqrt{\frac{(0.20 \text{ mm})/2}{0.001 \text{ mm}}} = 15 \text{ GPa} \quad (2.2 \times 10^6 \text{ psi}) \end{aligned}$$

Therefore, fracture will **not** occur since this value is less than  $E/10$ .

8.6 We may determine the critical stress required for the propagation of an internal crack in aluminum oxide using Equation (8.3); taking the value of  $393 \text{ GPa}$  (Table 12.5) as the modulus of elasticity, we get

$$\sigma_c = \sqrt{\frac{2E\gamma_s}{\pi a}}$$

$$= \sqrt{\frac{(2)(393 \times 10^9 \text{ N/m}^2)(0.90 \text{ N/m})}{(\pi)\left(\frac{4 \times 10^{-4} \text{ m}}{2}\right)}} = 33.6 \times 10^6 \text{ N/m}^2 = 33.6 \text{ MPa}$$

8.7 The maximum allowable surface crack length for MgO may be determined using Equation (8.3); taking the value of 225 GPa as the modulus of elasticity (Table 12.5), and solving for **a**, leads to

$$a = \frac{2E\gamma_s}{\pi\sigma_c^2} = \frac{(2)(225 \times 10^9 \text{ N/m}^2)(1.0 \text{ N/m})}{(\pi)(13.5 \times 10^6 \text{ N/m}^2)^2}$$

$$= 7.9 \times 10^{-4} \text{ m} = 0.79 \text{ mm} \text{ (0.031 in.)}$$

8.8W This problem calls for us to calculate the normal  $\sigma_x$  and  $\sigma_y$  stresses in front on a surface crack of length 2.0 mm at various positions when a tensile stress of 100 MPa is applied. Substitution for  $K = \sigma\sqrt{\pi a}$  into Equations (8.9aW) and (8.9bW) leads to

$$\sigma_x = \sigma f_x(\theta) \sqrt{\frac{a}{2r}}$$

$$\sigma_y = \sigma f_y(\theta) \sqrt{\frac{a}{2r}}$$

where  $f_x(\theta)$  and  $f_y(\theta)$  are defined in the accompanying footnote 2. For  $\theta = 0^\circ$ ,  $f_x(\theta) = 1.0$  and  $f_y(\theta) = 1.0$ , whereas for  $\theta = 45^\circ$ ,  $f_x(\theta) = 0.60$  and  $f_y(\theta) = 1.25$ .

(a) For  $r = 0.1 \text{ mm}$  and  $\theta = 0^\circ$ ,

$$\sigma_x = \sigma_y = \sigma(1.0) \sqrt{\frac{a}{2r}} = (100 \text{ MPa}) \sqrt{\frac{2.0 \text{ mm}}{(2)(0.1 \text{ mm})}} = 316 \text{ MPa} \text{ (45,800 psi)}$$

(b) For  $r = 0.1 \text{ mm}$  and  $\theta = 45^\circ$ ,

$$\sigma_x = \sigma(0.6) \sqrt{\frac{a}{2r}} = (100 \text{ MPa})(0.6) \sqrt{\frac{2.0 \text{ mm}}{(2)(0.1 \text{ mm})}} = 190 \text{ MPa} \text{ (27,500 psi)}$$

$$\sigma_y = \sigma(1.25) \sqrt{\frac{a}{2r}} = (100 \text{ MPa})(1.25) \sqrt{\frac{2.0 \text{ mm}}{(2)(0.1 \text{ mm})}} = 395 \text{ MPa} \text{ (57,300 psi)}$$



(c) For  $r = 0.5$  mm and  $\theta = 0^\circ$ ,

$$\sigma_x = \sigma_y = \sigma(1.0)\sqrt{\frac{a}{2r}} = (100 \text{ MPa})\sqrt{\frac{2.0 \text{ mm}}{(2)(0.5 \text{ mm})}} = 141 \text{ MPa} \quad (20,400 \text{ psi})$$

(d) For  $r = 0.5$  mm and  $\theta = 45^\circ$ ,

$$\sigma_x = \sigma(0.6)\sqrt{\frac{a}{2r}} = (100 \text{ MPa})(0.6)\sqrt{\frac{2.0 \text{ mm}}{(2)(0.5 \text{ mm})}} = 84.8 \text{ MPa} \quad (12,300 \text{ psi})$$

$$\sigma_y = \sigma(1.25)\sqrt{\frac{a}{2r}} = (100 \text{ MPa})(1.25)\sqrt{\frac{2.0 \text{ mm}}{(2)(0.5 \text{ mm})}} = 177 \text{ MPa} \quad (25,600 \text{ psi})$$

8.9W (a) In this portion of the problem we are asked to determine the radial position at which  $\sigma_x = 100$  MPa (14,500 psi) for  $\theta = 30^\circ$ ,  $a = 2.0$  mm, and  $\sigma = 150$  MPa (21,750 psi). Substitution for  $K$  into Equation (8.9aW) leads to

$$\sigma_x = \sigma f_x(\theta)\sqrt{\frac{a}{2r}}$$

Now, solving for  $r$  from this expression yields

$$r = \frac{a}{2} \left[ \frac{\sigma f_x(\theta)}{\sigma_x} \right]^2$$

For  $\theta = 30^\circ$ ,  $f_x(\theta) = 0.79$ , and therefore

$$r = \frac{2 \text{ mm}}{2} \left[ \frac{(150 \text{ MPa})(0.79)}{100 \text{ MPa}} \right]^2 = 1.40 \text{ mm} \quad (0.055 \text{ in.})$$

(b) Now we are asked to compute  $\sigma_y$  at this position. This is done by using Equation (8.9bW); for  $\theta = 30^\circ$ ,  $f_y(\theta) = 1.14$ , and therefore

$$\sigma_y = \sigma f_y(\theta)\sqrt{\frac{a}{2r}}$$

$$= (150 \text{ MPa})(1.14)\sqrt{\frac{2.0 \text{ mm}}{(2)(1.40 \text{ mm})}} = 145 \text{ MPa} \quad (21,000 \text{ psi})$$

8.10W (a) In this portion of the problem it is necessary to compute the stress at point **P** when the applied stress is 140 MPa (20,000 psi). In order to determine the stress concentration it is necessary to consult Figure 8.2cW. From the geometry of the specimen,  $w/h = (40 \text{ mm})/(20 \text{ mm}) = 2.0$ ; furthermore, the  $r/h$  ratio is  $(4 \text{ mm})/(20 \text{ mm}) = 0.20$ . Using the  $w/h = 2.0$  curve in Figure 8.2cW, the  $K_t$  value at  $r/h = 0.20$  is 1.8. And since  $K_t = \frac{\sigma_m}{\sigma_o}$ , then

$$\sigma_m = K_t \sigma_o = (1.8)(140 \text{ MPa}) = 252 \text{ MPa} \quad (36,000 \text{ psi})$$

(b) Now it is necessary to determine how much  $r$  must be increased to reduce  $\sigma_m$  by 25%; this reduction corresponds to a stress of  $(0.75)(252 \text{ MPa}) = 189 \text{ MPa}$  (27,000 psi). The value of  $K_t$  is therefore,  $K_t = \frac{\sigma_m}{\sigma_o} = \frac{189 \text{ MPa}}{140 \text{ MPa}} = 1.35$ . Using the  $w/h = 2.0$  curve in Figure 8.2cW, the value of  $r/h$  for  $K_t = 1.35$  is about 0.60. Therefore

$$r = (0.60)h = (0.60)(20 \text{ mm}) = 12.0 \text{ mm}$$

Or, the radius  $r$  must be increased from 4.0 mm to 12.0 mm in order to reduce the stress concentration by 25%.

8.11W (a) This portion of the problem calls for us to compute the stress at the edge of a circular through-the-thickness hole in a steel sheet when a tensile stress is applied in a length-wise direction. We first must utilize Figure 8.2aW-- $d/w = \frac{19 \text{ mm}}{127 \text{ mm}} = 0.15$ . From the figure and using this value,  $K_t =$

2.5. Since  $K_t = \frac{\sigma_m}{\sigma_o}$  and  $\sigma_o = 34.5 \text{ MPa}$  (5000 psi) then

$$\sigma_m = K_t \sigma_o = (2.5)(34.5 \text{ MPa}) = 86.3 \text{ MPa} \quad (12,500 \text{ psi})$$

(b) Now it becomes necessary to compute the stress at the hole edge when the external stress is applied in a width-wise direction; this simply means that  $w = 254 \text{ mm}$ . The  $d/w$  then is  $19 \text{ mm}/254 \text{ mm} = 0.075$ . From Figure 8.2aW,  $K_t$  is about 2.7. Therefore, for this situation

$$\sigma_m = K_t \sigma_o = (2.7)(34.5 \text{ MPa}) = 93.2 \text{ MPa} \quad (13,500 \text{ psi})$$

8.12W The stress intensity factor is a parameter used in expressions such as Equations (8.9W); its value is variable and dependent on applied stress and crack length according to the expression provided in Problem 8.8W. On the other hand, plane strain and plane stress fracture toughnesses represent unique and critical values of **K** at which crack propagation occurs. However, plane strain fracture toughness is this critical value for specimens thicker than some minimum threshold thickness, while plane stress is for specimens thinner than this threshold.

8.13W This problem calls for us to determine the value of **B**, the minimum component thickness for which the condition of plane strain is valid using Equation (8.14W), for the metal alloys listed in Table 8.1.

For the 7075-T651 aluminum alloy

$$B = 2.5 \left( \frac{K_{Ic}}{\sigma_y} \right)^2 = (2.5) \left( \frac{24 \text{ MPa}\sqrt{\text{m}}}{495 \text{ MPa}} \right)^2 = 0.0059 \text{ m} = 5.9 \text{ mm} \quad (0.23 \text{ in.})$$

For the 2024-T3 aluminum alloy

$$B = 2.5 \left( \frac{K_{Ic}}{\sigma_y} \right)^2 = (2.5) \left( \frac{44 \text{ MPa}\sqrt{\text{m}}}{345 \text{ MPa}} \right)^2 = 0.0406 \text{ m} = 40.6 \text{ mm} \quad (1.60 \text{ in.})$$

For the Ti-6Al-4V titanium alloy

$$B = (2.5) \left( \frac{55 \text{ MPa}\sqrt{\text{m}}}{910 \text{ MPa}} \right)^2 = 0.0091 \text{ m} = 9.1 \text{ mm} \quad (0.36 \text{ in.})$$

For the 4340 alloy steel tempered at 260°C

$$B = (2.5) \left( \frac{50 \text{ MPa}\sqrt{\text{m}}}{1640 \text{ MPa}} \right)^2 = 0.0023 \text{ m} = 2.3 \text{ mm} \quad (0.09 \text{ in.})$$

For the 4340 alloy steel tempered at 425°C

$$B = (2.5) \left( \frac{87.4 \text{ MPa}\sqrt{\text{m}}}{1420 \text{ MPa}} \right)^2 = 0.0095 \text{ m} = 9.5 \text{ mm} \quad (0.38 \text{ in.})$$

8.14 This problem asks us to determine whether or not the 4340 steel alloy specimen will fracture when exposed to a stress of 1030 MPa, given the values of  $K_{Ic}$ ,  $Y$ , and the largest value of  $a$  in the material. This requires that we solve for  $\sigma_c$  from Equation (8.7). Thus

$$\sigma_c = \frac{K_{Ic}}{Y\sqrt{\pi a}} = \frac{54.8 \text{ MPa}\sqrt{\text{m}}}{(1)\sqrt{(\pi)(0.5 \times 10^{-3} \text{ m})}} = 1380 \text{ MPa} \quad (199,500 \text{ psi})$$

Therefore, fracture will not occur because this specimen will tolerate a stress of 1380 MPa (199,500 psi) before fracture, which is greater than the applied stress of 1030 MPa (150,000 psi).

8.15 We are asked to determine if an aircraft component will fracture for a given fracture toughness ( $40 \text{ MPa}\sqrt{\text{m}}$ ), stress level (260 MPa), and maximum internal crack length (6.0 mm), given that fracture occurs for the same component using the same alloy for another stress level and internal crack length. It first becomes necessary to solve for the parameter  $Y$  for the conditions under which fracture occurred using Equation (8.5). Therefore,

$$Y = \frac{K_{Ic}}{\sigma\sqrt{\pi a}} = \frac{40 \text{ MPa}\sqrt{\text{m}}}{(300 \text{ MPa})\sqrt{(\pi)\left(\frac{4 \times 10^{-3} \text{ m}}{2}\right)}} = 1.68$$

Now we will solve for the product  $Y\sigma\sqrt{\pi a}$  for the other set of conditions, so as to ascertain whether or not this value is greater than the  $K_{Ic}$  for the alloy. Thus,

$$\begin{aligned} Y\sigma\sqrt{\pi a} &= (1.68)(260 \text{ MPa})\sqrt{(\pi)\left(\frac{6 \times 10^{-3} \text{ m}}{2}\right)} \\ &= 42.4 \text{ MPa}\sqrt{\text{m}} \quad (39 \text{ ksi}\sqrt{\text{in.}}) \end{aligned}$$

Therefore, fracture **will** occur since this value ( $42.4 \text{ MPa}\sqrt{\text{m}}$ ) is greater than the  $K_{Ic}$  of the material,  $40 \text{ MPa}\sqrt{\text{m}}$ .

8.16 This problem asks us to determine the stress level at which an aircraft component will fracture for a given fracture toughness ( $26 \text{ MPa}\sqrt{\text{m}}$ ) and maximum internal crack length (6.0 mm), given that fracture occurs for the same component using the same alloy at one stress level and another internal

crack length. It first becomes necessary to solve for the parameter  $Y$  for the conditions under which fracture occurred using Equation (8.5). Therefore,

$$Y = \frac{K_{Ic}}{\sigma\sqrt{\pi a}} = \frac{26 \text{ MPa}\sqrt{\text{m}}}{(112 \text{ MPa})\sqrt{(\pi)\left(\frac{8.6 \times 10^{-3} \text{ m}}{2}\right)}} = 2.0$$

Now we will solve for  $\sigma_c$  using Equation (8.6) as

$$\sigma_c = \frac{K_{Ic}}{Y\sqrt{\pi a}} = \frac{26 \text{ MPa}\sqrt{\text{m}}}{(2.0)\sqrt{(\pi)\left(\frac{6 \times 10^{-3} \text{ m}}{2}\right)}} = 134 \text{ MPa} \quad (19,300 \text{ psi})$$

8.17 For this problem, we are given values of  $K_{Ic}$ ,  $\sigma$ , and  $Y$  for a large plate and are asked to determine the minimum length of a surface crack that will lead to fracture. All we need do is to solve for  $a_c$  using Equation (8.7); therefore

$$a_c = \frac{1}{\pi} \left( \frac{K_{Ic}}{Y\sigma} \right)^2 = \frac{1}{\pi} \left[ \frac{82.4 \text{ MPa}\sqrt{\text{m}}}{(1)(345 \text{ MPa})} \right]^2 = 0.0182 \text{ m} = 18.2 \text{ mm} \quad (0.72 \text{ in.})$$

8.18 This problem asks us to calculate the maximum internal crack length allowable for the Ti-6Al-4V titanium alloy in Table 8.1 given that it is loaded to a stress level equal to one-half of its yield strength. For this alloy,  $K_{Ic} = 55 \text{ MPa}\sqrt{\text{m}}$  ( $50 \text{ ksi}\sqrt{\text{in.}}$ ); also,  $\sigma = \sigma_y/2 = (910 \text{ MPa})/2 = 455 \text{ MPa}$  ( $66,000 \text{ psi}$ ). Now solving for  $2a_c$  using Equation (8.7) yields

$$2a_c = \frac{2}{\pi} \left( \frac{K_{Ic}}{Y\sigma} \right)^2 = \frac{2}{\pi} \left[ \frac{55 \text{ MPa}\sqrt{\text{m}}}{(1.5)(455 \text{ MPa})} \right]^2 = 0.0041 \text{ m} = 4.1 \text{ mm} \quad (0.16 \text{ in.})$$

8.19 This problem asks that we determine whether or not a critical flaw in a wide plate is subject to detection given the limit of the flaw detection apparatus ( $3.0 \text{ mm}$ ), the value of  $K_{Ic}$  ( $98.9 \text{ MPa}\sqrt{\text{m}}$ ), the design stress ( $\sigma_y/2$  in which  $\sigma_y = 860 \text{ MPa}$ ), and  $Y = 1.0$ . We first need to compute the value of  $a_c$  using Equation (8.7); thus

$$a_c = \frac{1}{\pi} \left( \frac{K_{Ic}}{Y\sigma} \right)^2 = \frac{1}{\pi} \left[ \frac{98.9 \text{ MPa}\sqrt{\text{m}}}{(1.0)\left(\frac{860 \text{ MPa}}{2}\right)} \right]^2 = 0.0168 \text{ m} = 16.8 \text{ mm} \quad (0.66 \text{ in.})$$

Therefore, the critical flaw is subject to detection since this value of  $a_c$  is greater than the 3.0 mm resolution limit.

8.20W We are asked in this problem to determine whether or not it is possible to compute the critical length of a surface flaw within the flat plate given its thickness (25.4 mm), yield strength (700 MPa), plane strain fracture toughness [49.5 MPa $\sqrt{m}$  (45 ksi $\sqrt{in.}$ )] and the value of  $Y$  (1.65). The first thing we must do is to ascertain whether or not conditions of plane strain exist for this plate by using Equation (8.14W) as

$$B = 2.5 \left( \frac{K_{Ic}}{\sigma_y} \right)^2 = (2.5) \left( \frac{49.5 \text{ MPa}\sqrt{m}}{700 \text{ MPa}} \right)^2 = 0.0125 \text{ m} = 12.5 \text{ mm} \quad (0.50 \text{ in.})$$

The situation is one of plane strain since the thickness of the plate (25.4 mm) is greater than this calculated  $B$  (12.5 mm).

Now, in order to determine the value of  $a_c$  we utilize Equation (8.7):

$$a_c = \frac{1}{\pi} \left( \frac{K_{Ic}}{Y\sigma} \right)^2 = \frac{1}{\pi} \left[ \frac{49.5 \text{ MPa}\sqrt{m}}{(1.65) \left( \frac{700 \text{ MPa}}{2} \right)} \right]^2 = 0.0023 \text{ m} = 2.3 \text{ mm} \quad (0.092 \text{ in.})$$

8.21 The student should do this problem on his/her own.

8.22 (a) The plot of impact energy versus temperature is shown below.

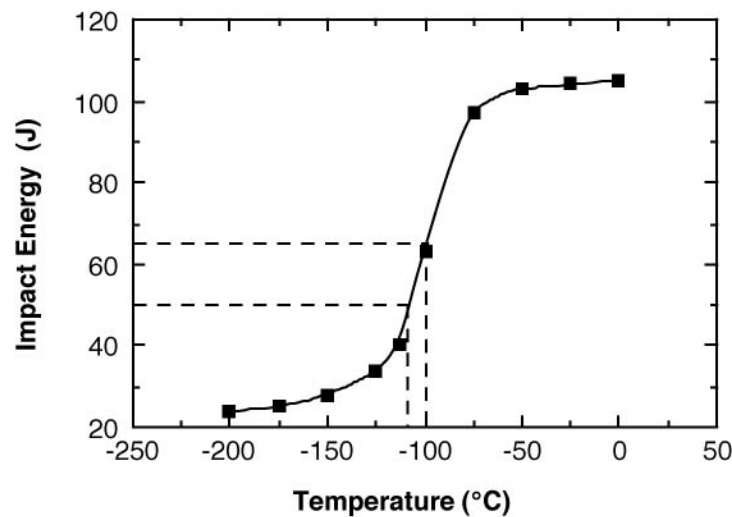

(b) The average of the maximum and minimum impact energies from the data is

$$\text{Average} = \frac{105 \text{ J} + 24 \text{ J}}{2} = 64.5 \text{ J}$$

As indicated on the plot by the one set of dashed lines, the ductile-to-brittle transition temperature according to this criterion is about -100°C.

(c) Also, as noted on the plot by the other set of dashed lines, the ductile-to-brittle transition temperature for an impact energy of 50 J is about -110°C.

8.23 The plot of impact energy versus temperature is shown below.

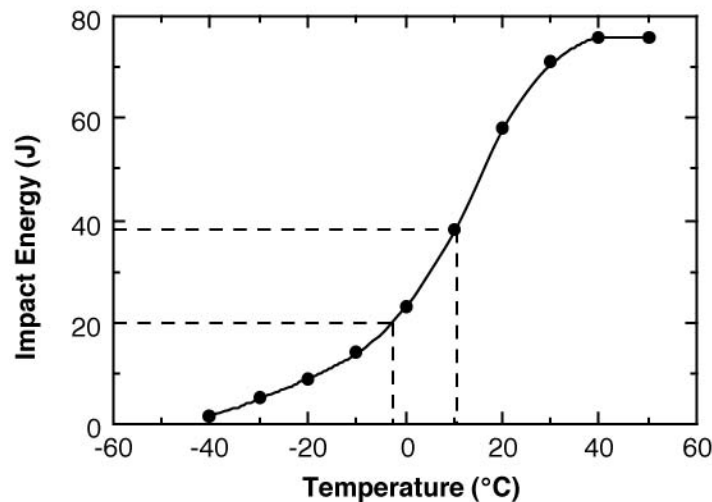

(b) The average of the maximum and minimum impact energies from the data is

$$\text{Average} = \frac{76 \text{ J} + 2 \text{ J}}{2} = 39 \text{ J}$$

As indicated on the plot by the one set of dashed lines, the ductile-to-brittle transition temperature according to this criterion is about 10°C.

(c) Also, as noted on the plot by the other set of dashed lines, the ductile-to-brittle transition temperature for an impact energy of 20 J is about -2°C.

8.24 With decreasing temperature, FCC metals do not experience a ductile-to-brittle transition because a relatively large number of slip systems remain operable at very low temperatures. On the other hand, BCC and HCP metals normally experience this transition because the number of operable slip systems decreases with decreasing temperature.

8.25 (a) Given the values of  $\sigma_m$  (70 MPa) and  $\sigma_a$  (210 MPa) we are asked to compute  $\sigma_{\max}$  and  $\sigma_{\min}$ . From Equation (8.14)

$$\sigma_m = \frac{\sigma_{\max} + \sigma_{\min}}{2} = 70 \text{ MPa}$$

Or,

$$\sigma_{\max} + \sigma_{\min} = 140 \text{ MPa}$$

Furthermore, utilization of Equation (8.16) yields

$$\sigma_a = \frac{\sigma_{\max} - \sigma_{\min}}{2} = 210 \text{ MPa}$$

Or,

$$\sigma_{\max} - \sigma_{\min} = 420 \text{ MPa}$$

Simultaneously solving these two expressions leads to

$$\begin{aligned}\sigma_{\max} &= 280 \text{ MPa} \quad (40,000 \text{ psi}) \\ \sigma_{\min} &= -140 \text{ MPa} \quad (-20,000 \text{ psi})\end{aligned}$$

(b) Using Equation (8.17) the stress ratio  $R$  is determined as follows:

$$R = \frac{\sigma_{\min}}{\sigma_{\max}} = \frac{-140 \text{ MPa}}{280 \text{ MPa}} = -0.50$$

(c) The magnitude of the stress range  $\sigma_r$  is determined using Equation (8.15) as

$$\sigma_r = \sigma_{\max} - \sigma_{\min} = 280 \text{ MPa} - (-140 \text{ MPa}) = 420 \text{ MPa} \quad (60,000 \text{ psi})$$

8.26 This problem asks that we determine the minimum allowable bar diameter to ensure that fatigue failure will not occur for a 1045 steel that is subjected to cyclic loading for a load amplitude of 66,700 N (15,000  $lb_f$ ). From Figure 8.44, the fatigue limit stress amplitude for this alloy is 310 MPa (45,000 psi). Stress is defined in Equation (6.1) as  $\sigma = \frac{F}{A_o}$ . For a cylindrical bar

$$A_o = \pi \left( \frac{d_o}{2} \right)^2$$



Now we may solve for  $d_o$  from these expressions, taking stress as the fatigue limit divided by the factor of safety. Thus

$$d_o = 2 \sqrt{\frac{F}{\pi \left( \frac{\sigma}{N} \right)}}$$

$$= (2) \sqrt{\frac{66,700 \text{ N}}{\pi \left( \frac{310 \times 10^6 \text{ N/m}^2}{2} \right)}} = 23.4 \times 10^{-3} \text{ m} = 23.4 \text{ mm} \text{ (0.92 in.)}$$

8.27 We are asked to determine the fatigue life for a cylindrical 2014-T6 aluminum rod given its diameter (6.4 mm) and the maximum tensile and compressive loads (+5340 N and -5340 N, respectively). The first thing that is necessary is to calculate values of  $\sigma_{\max}$  and  $\sigma_{\min}$  using Equation (6.1). Thus

$$\sigma_{\max} = \frac{F_{\max}}{A_o} = \frac{F_{\max}}{\pi \left( \frac{d_o}{2} \right)^2}$$

$$= \frac{5340 \text{ N}}{\pi \left( \frac{6.4 \times 10^{-3} \text{ m}}{2} \right)^2} = 166 \times 10^6 \text{ N/m}^2 = 166 \text{ MPa} \text{ (24,400 psi)}$$

$$\sigma_{\min} = \frac{F_{\min}}{\pi \left( \frac{d_o}{2} \right)^2}$$

$$= \frac{-5340 \text{ N}}{\pi \left( \frac{6.4 \times 10^{-3} \text{ m}}{2} \right)^2} = -166 \times 10^6 \text{ N/m}^2 = -166 \text{ MPa} \text{ (-24,400 psi)}$$

Now it becomes necessary to compute the stress amplitude using Equation (8.16) as

$$\sigma_a = \frac{\sigma_{\max} - \sigma_{\min}}{2} = \frac{166 \text{ MPa} - (-166 \text{ MPa})}{2} = 166 \text{ MPa} \text{ (24,400 psi)}$$

From Figure 8.44, for the 2014-T6 aluminum, the number of cycles to failure at this stress amplitude is about  $1 \times 10^7$  cycles.

8.28 This problem asks that we compute the maximum and minimum loads to which a 15.2 mm (0.60 in.) diameter 2014-T6 aluminum alloy specimen may be subjected in order to yield a fatigue life of  $1.0 \times 10^8$  cycles; Figure 8.44 is to be used assuming that data were taken for a mean stress of 35 MPa (5,000 psi). Upon consultation of Figure 8.44, a fatigue life of  $1.0 \times 10^8$  cycles corresponds to a stress amplitude of 140 MPa (20,000 psi). Or, from Equation (8.16)

$$\sigma_{\max} - \sigma_{\min} = 2\sigma_a = (2)(140 \text{ MPa}) = 280 \text{ MPa} \quad (40,000 \text{ psi})$$

Since  $\sigma_m = 35 \text{ MPa}$ , then from Equation (8.14)

$$\sigma_{\max} + \sigma_{\min} = 2\sigma_m = (2)(35 \text{ MPa}) = 70 \text{ MPa} \quad (10,000 \text{ psi})$$

Simultaneous solution of these two expressions for  $\sigma_{\max}$  and  $\sigma_{\min}$  yields

$\sigma_{\max} = +175 \text{ MPa}$  (+25,000 psi) and  $\sigma_{\min} = -105 \text{ MPa}$  (-15,000 psi). Now, inasmuch as  $\sigma = \frac{F}{A_o}$

[Equation (6.1)], and  $A_o = \pi \left( \frac{d_o}{2} \right)^2$  then

$$F_{\max} = \frac{\sigma_{\max} \pi d_o^2}{4} = \frac{(175 \times 10^6 \text{ N/m}^2)(\pi)(15.2 \times 10^{-3} \text{ m})^2}{4} = 31,750 \text{ N} \quad (7070 \text{ lb}_f)$$

$$F_{\min} = \frac{\sigma_{\min} \pi d_o^2}{4} = \frac{(-105 \times 10^6 \text{ N/m}^2)(\pi)(15.2 \times 10^{-3} \text{ m})^2}{4} = -19,000 \text{ N} \quad (-4240 \text{ lb}_f)$$

8.29 (a) The fatigue data for this alloy are plotted below.

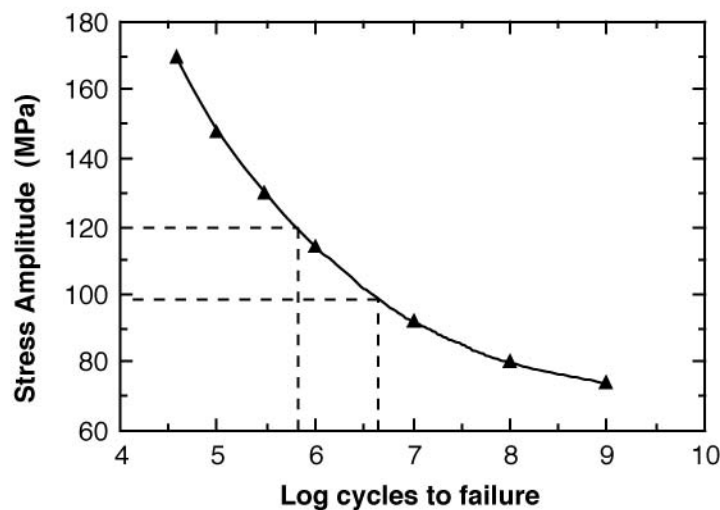

(b) As indicated by one set of dashed lines on the plot, the fatigue strength at  $4 \times 10^6$  cycles [ $\log(4 \times 10^6) = 6.6$ ] is about 100 MPa.

(c) As noted by the other set of dashed lines, the fatigue life for 120 MPa is about  $6 \times 10^5$  cycles (i.e., the log of the lifetime is about 5.8).

8.30 We are asked to compute the maximum torsional stress amplitude possible at each of several fatigue lifetimes for the brass alloy the fatigue behavior of which is given in Problem 8.29. For each lifetime, first compute the number of cycles, and then read the corresponding fatigue strength from the above plot.

(a) Fatigue lifetime = (1 yr)(365 days/year)(24 h/day)(60 min/h)(1800 cycles/min) =  $9.5 \times 10^8$  cycles. The stress amplitude corresponding to this lifetime is about 74 MPa.

(b) Fatigue lifetime = (30 days)(24 h/day)(60 min/h)(1800 cycles/min) =  $7.8 \times 10^7$  cycles. The stress amplitude corresponding to this lifetime is about 80 MPa.

(c) Fatigue lifetime = (24 h)(60 min/h)(1800 cycles/min) =  $2.6 \times 10^6$  cycles. The stress amplitude corresponding to this lifetime is about 103 MPa.

(d) Fatigue lifetime = (60 min/h)(1800 cycles/min) = 108,000 cycles. The stress amplitude corresponding to this lifetime is about 145 MPa.

8.31 (a) The fatigue data for this alloy are plotted below.

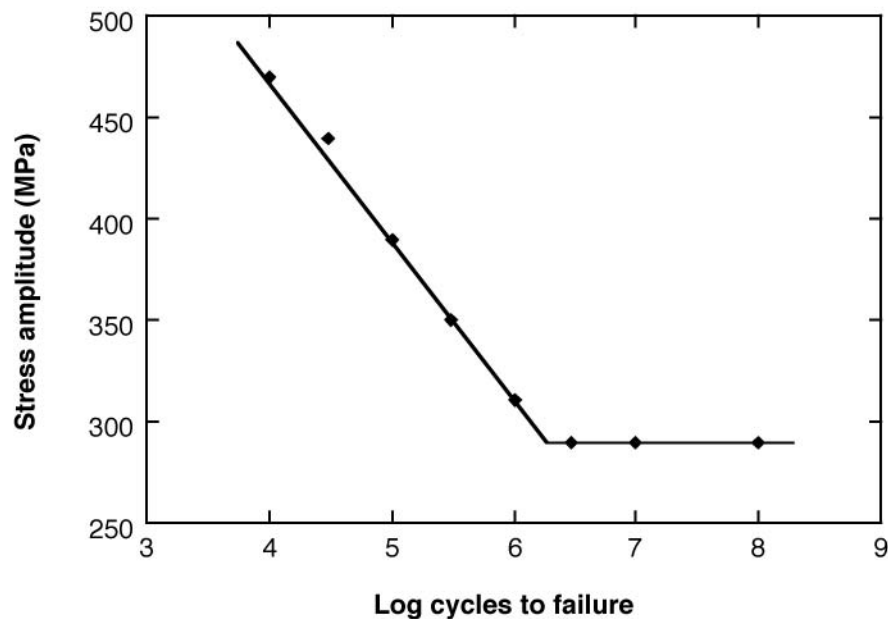

(b) The fatigue limit is the stress level at which the curve becomes horizontal, which is 290 MPa (42,200 psi).

(c) From the plot, the fatigue lifetimes at a stress amplitude of 415 MPa (60,000 psi) is about 50,000 cycles ( $\log N = 4.7$ ). At 275 MPa (40,000 psi) the fatigue lifetime is essentially an infinite number of cycles since this stress amplitude is below the fatigue limit.

(d) Also from the plot, the fatigue strengths at  $2 \times 10^4$  cycles ( $\log N = 4.30$ ) and  $6 \times 10^5$  cycles ( $\log N = 5.78$ ) are 440 MPa (64,000 psi) and 325 MPa (47,500 psi), respectively.

8.32 This problem asks that we determine the maximum lifetimes of continuous driving that are possible at an average rotational velocity of 600 rpm for the alloy the fatigue data of which is provided in Problem 8.31 and at a variety of stress levels.

(a) For a stress level of 450 MPa (65,000 psi), the fatigue lifetime is approximately 18,000 cycles. This translates into  $(1.8 \times 10^4 \text{ cycles})(1 \text{ min}/600 \text{ cycles}) = 30 \text{ min}$ .

(b) For a stress level of 380 MPa (55,000 psi), the fatigue lifetime is approximately  $1.5 \times 10^5$  cycles. This translates into  $(1.5 \times 10^5 \text{ cycles})(1 \text{ min}/600 \text{ cycles}) = 250 \text{ min} = 4.2 \text{ h}$ .

(c) For a stress level of 310 MPa (45,000 psi), the fatigue lifetime is approximately  $1 \times 10^6$  cycles. This translates into  $(1 \times 10^6 \text{ cycles})(1 \text{ min}/600 \text{ cycles}) = 1667 \text{ min} = 27.8 \text{ h}$ .

(d) For a stress level of 275 MPa (40,000 psi), the fatigue lifetime is essentially infinite since we are below the fatigue limit.

8.33 For this problem we are given, for three identical fatigue specimens of the same material,  $\sigma_{\max}$  and  $\sigma_{\min}$  data and are asked to rank the lifetimes from the longest to the shortest. In order to do this it is necessary to compute both the mean stress and stress amplitude for each specimen. Since from Equation (8.14)

$$\sigma_m = \frac{\sigma_{\max} + \sigma_{\min}}{2}$$

$$\sigma_m(\text{A}) = \frac{450 \text{ MPa} + (-150 \text{ MPa})}{2} = 150 \text{ MPa}$$

$$\sigma_m(\text{B}) = \frac{300 \text{ MPa} + (-300 \text{ MPa})}{2} = 0 \text{ MPa}$$

$$\sigma_m(\text{C}) = \frac{500 \text{ MPa} + (-200 \text{ MPa})}{2} = 150 \text{ MPa}$$

Furthermore, using Equation (8.16)

$$\sigma_a = \frac{\sigma_{\max} - \sigma_{\min}}{2}$$

$$\sigma_a(A) = \frac{450 \text{ MPa} - (-150 \text{ MPa})}{2} = 300 \text{ MPa}$$

$$\sigma_a(B) = \frac{300 \text{ MPa} - (-300 \text{ MPa})}{2} = 300 \text{ MPa}$$

$$\sigma_a(C) = \frac{500 \text{ MPa} - (-200 \text{ MPa})}{2} = 350 \text{ MPa}$$

On the basis of these results, the fatigue lifetime for specimen B will be greater than specimen A which in turn will be greater than specimen C. This conclusion is based upon the following **S-N** plot on which curves are plotted for two  $\sigma_m$  values.

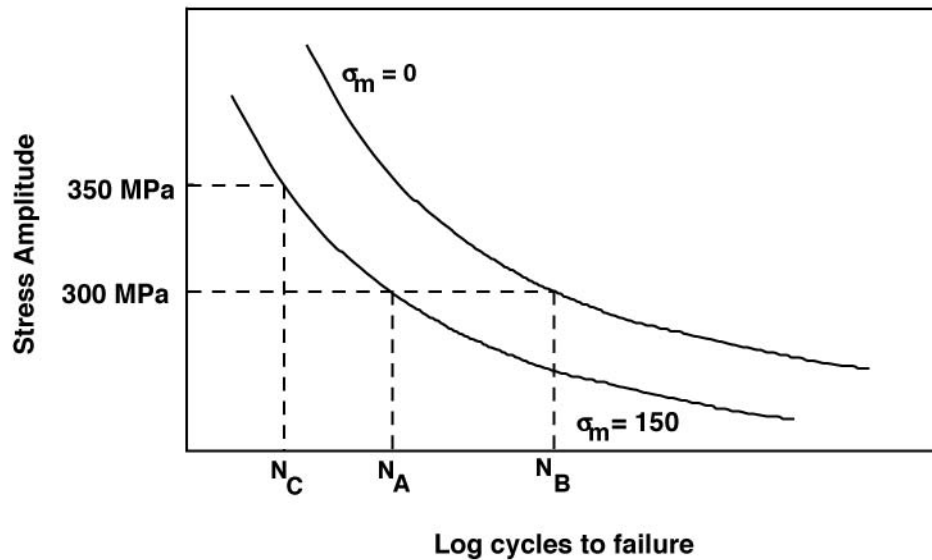

8.34 Five factors that lead to scatter in fatigue life data are 1) specimen fabrication and surface preparation, 2) metallurgical variables, 3) specimen alignment in the test apparatus, 4) variation in mean stress, and 5) variation in test cycle frequency.

8.35 For a stress ratio (**R**) of +1, then, from Equation (8.17),

$$\sigma_{\max} = \sigma_{\min}$$

This is to say that the stress remains constant (or does not fluctuate) with time. Thus, the fatigue plot would appear as

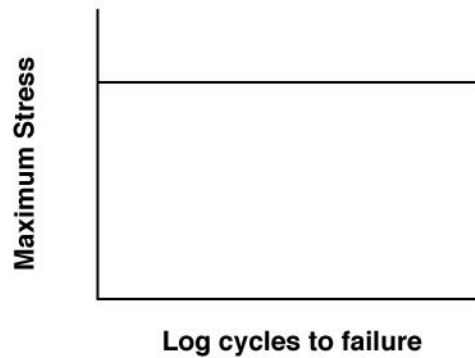

8.36 This question asks us to demonstrate that increasing  $R$  produces a decrease in  $\sigma_a$ . From Equation (8.17)

$$\sigma_{\min} = R\sigma_{\max}$$

Furthermore, Equation (8.16) is

$$\sigma_a = \frac{\sigma_{\max} - \sigma_{\min}}{2}$$

Incorporation of the former expression into the latter gives

$$\sigma_a = \frac{\sigma_{\max} - R\sigma_{\max}}{2} = \frac{\sigma_{\max}}{2}(1 - R)$$

Therefore, as the magnitude of  $R$  increases (or becomes more positive) the magnitude of  $\sigma_a$  decreases.

8.37 To crystallize means to become crystalline. Thus, the statement "The metal fractured because it crystallized" is erroneous inasmuch as the metal was crystalline prior to being stressed (virtually all metals are crystalline).

8.38 (a) With regard to size, beachmarks are normally of macroscopic dimensions and may be observed with the naked eye; fatigue striations are of microscopic size and it is necessary to observe them using electron microscopy.

(b) With regard to origin, beachmarks result from interruptions in the stress cycles; each fatigue striation corresponds to the advance of a fatigue crack during a single load cycle.

8.39 Four measures that may be taken to increase the fatigue resistance of a metal alloy are:

- 1) Polish the surface to remove stress amplification sites.
- 2) Reduce the number of internal defects (pores, etc.) by means of altering processing and fabrication techniques.
- 3) Modify the design to eliminate notches and sudden contour changes.
- 4) Harden the outer surface of the structure by case hardening (carburizing, nitriding) or shot peening.

8.40 Creep becomes important at  $0.4T_m$ ,  $T_m$  being the absolute melting temperature of the metal.

For Ni,  $0.4T_m = (0.4)(1455 + 273) = 691 \text{ K}$  or  $418^\circ\text{C}$  ( $785^\circ\text{F}$ )

For Cu,  $0.4T_m = (0.4)(1085 + 273) = 543 \text{ K}$  or  $270^\circ\text{C}$  ( $518^\circ\text{F}$ )

For Fe,  $0.4T_m = (0.4)(1538 + 273) = 725 \text{ K}$  or  $450^\circ\text{C}$  ( $845^\circ\text{F}$ )

For W,  $0.4T_m = (0.4)(3410 + 273) = 1473 \text{ K}$  or  $1200^\circ\text{C}$  ( $2190^\circ\text{F}$ )

For Pb,  $0.4T_m = (0.4)(327 + 273) = 240 \text{ K}$  or  $-33^\circ\text{C}$  ( $-27^\circ\text{F}$ )

For Al,  $0.4T_m = (0.4)(660 + 273) = 373 \text{ K}$  or  $100^\circ\text{C}$  ( $212^\circ\text{F}$ )

8.41 Schematic creep curves at both constant stress and constant load are shown below.

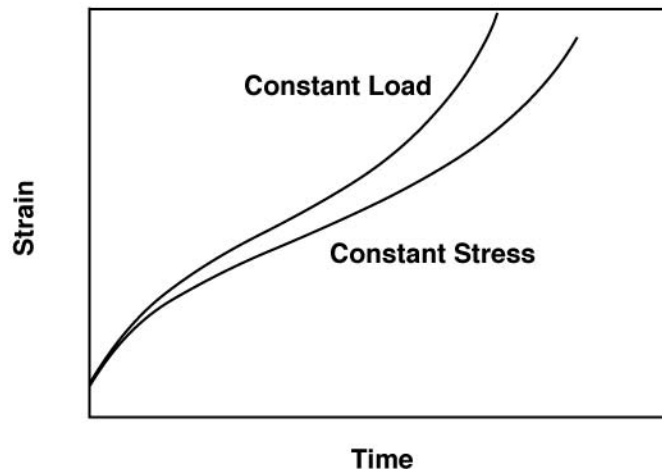

With increasing time, the constant load curve becomes progressively higher than the constant stress curve. Since these tests are tensile ones, the cross-sectional area diminishes as deformation progresses. Thus, in order to maintain a constant stress, the applied load must correspondingly be diminished since  $\text{stress} = \text{load}/\text{area}$ .

8.42 These creep data are plotted below.

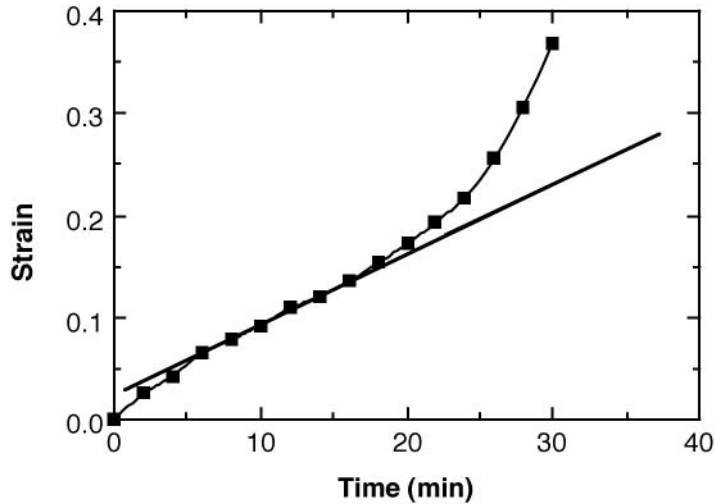

The steady-state creep rate ( $\Delta\varepsilon/\Delta t$ ) is the slope of the linear region as

$$\frac{\Delta\varepsilon}{\Delta t} = \frac{0.230 - 0.09}{30 \text{ min} - 10 \text{ min}} = 7.0 \times 10^{-3} \text{ min}^{-1}$$

8.43 This problem asks that we determine the total elongation of a low carbon-nickel alloy that is exposed to a tensile stress of 70 MPa (10,000 psi) at 427°C for 10,000 h; the instantaneous and primary creep elongations are 1.3 mm (0.05 in.).

From the 427°C line in Figure 8.29, the steady state creep rate,  $\dot{\varepsilon}_s$ , is about 0.035 %/1000 h (or  $3.5 \times 10^{-5}$  %/h) at 70 MPa. The steady state creep strain,  $\varepsilon_s$ , therefore, is just the product of  $\dot{\varepsilon}_s$  and time as

$$\begin{aligned} \varepsilon_s &= \dot{\varepsilon}_s \times (\text{time}) \\ &= (3.5 \times 10^{-5} \text{ %/h})(10,000 \text{ h}) = 0.35 \text{ \%} = 3.5 \times 10^{-3} \end{aligned}$$

Strain and elongation are related as in Equation (6.2); solving for the steady state elongation,  $\Delta l_s$ , leads to

$$\Delta l_s = l_0 \varepsilon_s = (1015 \text{ mm})(3.5 \times 10^{-3}) = 3.6 \text{ mm} \quad (0.14 \text{ in.})$$

Finally, the total elongation is just the sum of this  $\Delta l_s$  and the total of both instantaneous and primary creep elongations [i.e., 1.3 mm (0.05 in.)]. Therefore, the total elongation is 4.9 mm (0.19 in.).



8.44 We are asked to determine the tensile load necessary to elongate a 635 mm long low carbon-nickel alloy specimen 6.4 mm after 5,000 h at 538°C. It is first necessary to calculate the steady state creep rate so that we may utilize Figure 8.29 in order to determine the tensile stress. The steady state elongation,  $\Delta l_s$ , is just the difference between the total elongation and the sum of the instantaneous and primary creep elongations; that is,

$$\Delta l_s = 6.4 \text{ mm} - 1.8 \text{ mm} = 4.6 \text{ mm} \quad (0.18 \text{ in.})$$

Now the steady state creep rate,  $\dot{\epsilon}_s$  is just

$$\begin{aligned} \dot{\epsilon}_s &= \frac{\Delta \epsilon}{\Delta t} = \frac{\Delta l_s / l_0}{\Delta t} = \frac{(4.6 \text{ mm}) / (635 \text{ mm})}{5,000 \text{ h}} \\ &= 1.45 \times 10^{-6} \text{ (h)}^{-1} = 0.145 \% / 1000 \text{ h} \end{aligned}$$

Employing the 538°C line in Figure 8.29, a steady state creep rate of 0.145 %/1000 h corresponds to a stress  $\sigma$  of about 40 MPa (5,800 psi). From this we may compute the tensile load using Equation (6.1) as

$$\begin{aligned} F &= \sigma A_0 = \sigma \pi \left( \frac{d_0}{2} \right)^2 \\ &= (40 \times 10^6 \text{ N/m}^2) \pi \left( \frac{19.0 \times 10^{-3} \text{ m}}{2} \right)^2 = 11,300 \text{ N} \quad (2560 \text{ lb}_f) \end{aligned}$$

8.45 This problem asks us to calculate the rupture lifetime of a component fabricated from a low carbon-nickel alloy exposed to a tensile stress of 31 MPa at 649°C. All that we need do is read from the 649°C line in Figure 8.28 the rupture lifetime at 31 MPa; this value is about 10,000 h.

8.46 We are asked in this problem to determine the maximum load that may be applied to a cylindrical low carbon-nickel alloy component that must survive 10,000 h at 538°C. From Figure 8.28, the stress corresponding to  $10^4$  h is 70 MPa (10,000 psi). Since stress is defined in Equation (6.1) as  $\sigma = F/A_0$ , and for a cylindrical specimen,  $A_0 = \pi r_0^2$ , then

$$F = \sigma A_0 = \sigma \pi \left( \frac{d_0}{2} \right)^2$$

$$= (70 \times 10^6 \text{ N/m}^2)(\pi) \left( \frac{19.1 \times 10^{-3} \text{ m}}{2} \right)^2 = 20,000 \text{ N} \quad (4420 \text{ lb}_f)$$

8.47 The slope of the line from a  $\log \dot{\gamma}_s$  versus  $\log \sigma$  plot yields the value of  $n$  in Equation (8.19); that is

$$n = \frac{\Delta \log \dot{\gamma}_s}{\Delta \log \sigma}$$

We are asked to determine the values of  $n$  for the creep data at the three temperatures in Figure 8.29. This is accomplished by taking ratios of the differences between two  $\log \dot{\gamma}_s$  and  $\log \sigma$  values.

Thus for 427°C

$$n = \frac{\Delta \log \dot{\gamma}_s}{\Delta \log \sigma} = \frac{\log(10^{-1}) - \log(10^{-2})}{\log(85 \text{ MPa}) - \log(55 \text{ MPa})} = 5.3$$

While for 538°C

$$n = \frac{\Delta \log \dot{\gamma}_s}{\Delta \log \sigma} = \frac{\log(1.0) - \log(10^{-2})}{\log(59 \text{ MPa}) - \log(23 \text{ MPa})} = 4.9$$

And at 649°C

$$n = \frac{\Delta \log \dot{\gamma}_s}{\Delta \log \sigma} = \frac{\log(1.0) - \log(10^{-2})}{\log(15 \text{ MPa}) - \log(8.3 \text{ MPa})} = 7.8$$

8.48 (a) We are asked to estimate the activation energy for creep for the low carbon-nickel alloy having the steady-state creep behavior shown in Figure 8.29, using data taken at  $\sigma = 55 \text{ MPa}$  (8000 psi) and temperatures of 427°C and 538°C. Since  $\sigma$  is a constant, Equation (8.20) takes the form

$$\dot{\gamma}_s = K_2 \sigma^n \exp\left(-\frac{Q_c}{RT}\right) = K'_2 \exp\left(-\frac{Q_c}{RT}\right)$$

where  $K'_2$  is now a constant. (Note: the exponent  $n$  has about the same value at these two temperatures per Problem 8.47.) Taking natural logarithms of the above expression

$$\ln \dot{\gamma}_s = \ln K'_2 - \frac{Q_c}{RT}$$

For the case in which we have creep data at two temperatures (denoted as  $T_1$  and  $T_2$ ) and their corresponding steady-state creep rates ( $\dot{\gamma}_{s1}$  and  $\dot{\gamma}_{s2}$ ), it is possible to set up two simultaneous equations of the form as above, with two unknowns, namely  $K'_2$  and  $Q_c$ . Solving for  $Q_c$  yields

$$Q_c = - \frac{R \left( \ln \dot{\gamma}_{s1} - \ln \dot{\gamma}_{s2} \right)}{\left[ \frac{1}{T_1} - \frac{1}{T_2} \right]}$$

Let us choose  $T_1$  as 427°C (700 K) and  $T_2$  as 538°C (811 K); then from Figure 8.29, at  $\sigma = 55$  MPa,  $\dot{\gamma}_{s1} = 0.01 \text{ \%}/1000 \text{ h} = 1 \times 10^{-7} \text{ (h)}^{-1}$  and  $\dot{\gamma}_{s2} = 0.8 \text{ \%}/1000 \text{ h} = 0.8 \times 10^{-5} \text{ (h)}^{-1}$ . Substitution of these values into the above equation leads to

$$Q_c = - \frac{(8.31 \text{ J/mol} \cdot \text{K}) \left[ \ln (10^{-7}) - \ln (0.8 \times 10^{-5}) \right]}{\left[ \frac{1}{700 \text{ K}} - \frac{1}{811 \text{ K}} \right]}$$

$$= 186,200 \text{ J/mol}$$

(b) We are now asked to calculate  $\dot{\gamma}_s$  at 649°C (922 K). It is first necessary to determine the value of  $K'_2$ , which is accomplished using the first expression above, the value of  $Q_c$ , and one value each of  $\dot{\gamma}_s$  and  $T$  (say  $\dot{\gamma}_{s1}$  and  $T_1$ ). Thus,

$$K'_2 = \dot{\gamma}_{s1} \exp \left( \frac{Q_c}{RT_1} \right)$$

$$= \left[ 10^{-7} \text{ (h)}^{-1} \right] \exp \left[ \frac{186,200 \text{ J/mol}}{(8.31 \text{ J/mol} \cdot \text{K})(700 \text{ K})} \right] = 8.0 \times 10^6 \text{ (h)}^{-1}$$

Now it is possible to calculate  $\dot{\gamma}_s$  at 922 K as follows:

$$\dot{\gamma}_s = K'_2 \exp \left( - \frac{Q_c}{RT} \right)$$

$$= \left[ 8.0 \times 10^{-6} (\text{h})^{-1} \right] \exp \left[ \frac{186,200 \text{ J/mol}}{(8.31 \text{ J/mol} \cdot \text{K})(922 \text{ K})} \right]$$

$$= 2.23 \times 10^{-4} (\text{h})^{-1} = 22.3 \text{ \%}/1000 \text{ h}$$

8.49 This problem gives  $\dot{\gamma}_s$  values at two different stress levels and 200°C, and the activation energy for creep, and asks that we determine the steady-state creep rate at 250°C and 48 MPa (7000 psi).

Taking the natural logarithm of Equation (8.20) yields

$$\ln \dot{\gamma}_s = \ln K_2 + n \ln \sigma - \frac{Q_c}{RT}$$

With the given data there are two unknowns in this equation--namely  $K_2$  and  $n$ . Using the data provided in the problem we can set up two independent equations as follows:

$$\ln \left[ 2.5 \times 10^{-3} (\text{h})^{-1} \right] = \ln K_2 + n \ln (55 \text{ MPa}) - \frac{140,000 \text{ J/mol}}{(8.31 \text{ J/mol} \cdot \text{K})(473 \text{ K})}$$

$$\ln \left[ 2.4 \times 10^{-2} (\text{h})^{-1} \right] = \ln K_2 + n \ln (69 \text{ MPa}) - \frac{140,000 \text{ J/mol}}{(8.31 \text{ J/mol} \cdot \text{K})(473 \text{ K})}$$

Now, solving simultaneously for  $K_2$  and  $n$  leads to  $n = 9.97$  and  $K_2 = 3.27 \times 10^{-5} (\text{h})^{-1}$ . Thus it is now possible to solve for  $\dot{\gamma}_s$  at 48 MPa and 523 K using Equation (8.20) as

$$\dot{\gamma}_s = K_2 \sigma^n \exp \left( -\frac{Q_c}{RT} \right)$$

$$= \left[ 3.27 \times 10^{-5} (\text{h})^{-1} \right] (48 \text{ MPa})^{9.97} \exp \left[ -\frac{140,000 \text{ J/mol}}{(8.31 \text{ J/mol} \cdot \text{K})(523 \text{ K})} \right]$$

$$1.94 \times 10^{-2} (\text{h})^{-1}$$

8.50 This problem gives  $\dot{\gamma}_s$  values at two different temperatures and 140 MPa (20,000 psi), and the stress exponent  $n = 8.5$ , and asks that we determine the steady-state creep rate at a stress of 83 MPa (12,000 psi) and 1300 K.

Taking the natural logarithm of Equation (8.20) yields

$$\ln \dot{\epsilon}_s = \ln K_2 + n \ln \sigma - \frac{Q_c}{RT}$$

With the given data there are two unknowns in this equation--namely  $K_2$  and  $Q_c$ . Using the data provided in the problem we can set up two independent equations as follows:

$$\ln \left[ 6.6 \times 10^{-4} (\text{h})^{-1} \right] = \ln K_2 + (8.5) \ln(140 \text{ MPa}) - \frac{Q_c}{(8.31 \text{ J/mol-K})(1090 \text{ K})}$$

$$\ln \left[ 8.8 \times 10^{-2} (\text{h})^{-1} \right] = \ln K_2 + (8.5) \ln(140 \text{ MPa}) - \frac{Q_c}{(8.31 \text{ J/mol-K})(1200 \text{ K})}$$

Now, solving simultaneously for  $K_2$  and  $Q_c$  leads to  $K_2 = 57.5 (\text{h})^{-1}$  and  $Q_c = 483,500 \text{ J/mol}$ . Thus, it is now possible to solve for  $\dot{\epsilon}_s$  at 83 MPa and 1300 K using Equation (8.20) as

$$\begin{aligned} \dot{\epsilon}_s &= K_2 \sigma^n \exp \left( -\frac{Q_c}{RT} \right) \\ &= \left[ 57.5 (\text{h})^{-1} \right] (83 \text{ MPa})^{8.5} \exp \left[ -\frac{483,500 \text{ J/mol}}{(8.31 \text{ J/mol-K})(1300 \text{ K})} \right] \\ &= 4.31 \times 10^{-2} (\text{h})^{-1} \end{aligned}$$

8.51 Three metallurgical/processing techniques that are employed to enhance the creep resistance of metal alloys are 1) solid solution alloying, 2) dispersion strengthening by using an insoluble second phase, and 3) increasing the grain size or producing a grain structure with a preferred orientation.

### Design Problems

8.D1W This problem asks us to calculate the minimum  $K_{Ic}$  necessary to ensure that failure will not occur for a flat plate given the following: an expression from which  $Y(a/W)$  may be determined, the internal crack length,  $2a$  (25 mm), the plate width,  $W$  (100 mm), and the value of  $\sigma$  (415 MPa). First we compute the value of  $Y(a/W)$  using Equation (8.12W), as follows:

$$Y(a/W) = \left[ \frac{W}{\pi a} \tan \frac{\pi a}{W} \right]^{1/2}$$

$$= \left[ \frac{100 \text{ mm}}{(\pi)(12.5 \text{ mm})} \tan \frac{(\pi)(12.5 \text{ mm})}{100 \text{ mm}} \right]^{1/2} = 1.027$$

Now, using Equation (8.13W) [or Equation (8.5)] it is possible to determine  $K_{Ic}$ ; thus

$$\begin{aligned} K_{Ic} &= Y(a/W)\sigma\sqrt{\pi a} \\ &= (1.027)(415 \text{ MPa})\sqrt{(\pi)(12.5 \times 10^{-3} \text{ m})} = 84.5 \text{ MPa}\sqrt{\text{m}} \quad (77.2 \text{ ksi}\sqrt{\text{in.}}) \end{aligned}$$

8.D2W For this problem we are asked to determine the critical crack length for a flat plate containing a centrally positioned, through-thickness crack as shown in Figure 8.6W; for this plate,  $K_{Ic} = 50 \text{ MPa}\sqrt{\text{m}}$ ,  $W = 60 \text{ mm}$ , and the design stress  $\sigma = 375 \text{ MPa}$ . The plane-strain fracture toughness is defined by Equation (8.13W) [or Equation (8.5)]; furthermore, for this case,  $Y$  is a function of crack length  $a$  and plate width  $W$  according to Equation (8.12W). Combining these expressions leads to

$$\begin{aligned} K_{Ic} &= Y(a/W)\sigma\sqrt{\pi a} \\ &= \left[ \frac{W}{\pi a} \tan \frac{\pi a}{W} \right]^{1/2} \sigma\sqrt{\pi a} \\ &= \sigma \left[ W \tan \left( \frac{\pi a}{W} \right) \right]^{1/2} \end{aligned}$$

Now solving this expression for  $a$  which is just the critical crack length  $a_c$  yields

$$\begin{aligned} a_c &= \left( \frac{W}{\pi} \right) \tan^{-1} \left[ \frac{K_{Ic}^2}{\sigma^2 W} \right] \\ &= \left( \frac{60 \times 10^{-3} \text{ m}}{\pi} \right) \tan^{-1} \left[ \frac{(50 \text{ MPa}\sqrt{\text{m}})^2}{(375 \text{ MPa})^2 (60 \times 10^{-3} \text{ m})} \right] \\ &= 5.5 \times 10^{-3} \text{ m} = 5.5 \text{ mm} \quad (0.22 \text{ in.}) \end{aligned}$$

8.D3W This problem asks that we determine, for a steel plate having a through-thickness edge crack, the minimum allowable plate width to ensure that fracture will not occur if the minimum crack length that is subject to detection is 3 mm (0.12 in.). We are also given that  $K_{Ic} = 65 \text{ MPa}\sqrt{\text{m}}$  and that the plate may be loaded to half its yield strength, where  $\sigma_y = 1000 \text{ MPa}$ . First of all the applied stress is just

$$\sigma = \frac{\sigma_y}{2} = \frac{1000 \text{ MPa}}{2} = 500 \text{ MPa} \quad (72,500 \text{ psi})$$

Now, using Equation (8.13W) [equivalently Equation (8.5)] we solve for the value of  $Y$  assuming that  $a = 3.0 \text{ mm}$ , as

$$\begin{aligned} Y &= \frac{K_{Ic}}{\sigma\sqrt{\pi a}} \\ &= \frac{65 \text{ MPa}\sqrt{\text{m}}}{(500 \text{ MPa})\sqrt{(\pi)(3 \times 10^{-3} \text{ m})}} = 1.34 \end{aligned}$$

In Figure 8.7aW is plotted  $Y$  versus  $a/W$  for the crack-plate geometry of this problem; from this plot, for  $Y = 1.34$ ,  $a/W = 0.20$ . Since the minimum crack length for detection is 3 mm, the minimum width allowable is just

$$W = \frac{a}{0.20} = \frac{3 \text{ mm}}{0.20} = 15 \text{ mm} \quad (0.60 \text{ in.})$$

8.D4W This problem asks that we consider a steel plate having a through-thickness edge crack, and to determine if fracture will occur given the following:  $W = 40 \text{ mm}$ ,  $B = 6.0 \text{ mm}$ ,  $K_{Ic} = 60 \text{ MPa}\sqrt{\text{m}}$  ( $54.6 \text{ ksi}\sqrt{\text{in.}}$ ),  $\sigma_y = 1400 \text{ MPa}$ ,  $\sigma = 200 \text{ MPa}$ , and  $a = 16 \text{ mm}$ . The first thing to do is determine whether conditions of plane strain exist. From Equation (8.14W),

$$\begin{aligned} &2.5 \left( \frac{K_{Ic}}{\sigma_y} \right)^2 \\ &= 2.5 \left( \frac{60 \text{ MPa}\sqrt{\text{m}}}{1400 \text{ MPa}} \right)^2 = 0.0046 \text{ m} = 4.6 \text{ mm} \quad (0.19 \text{ in.}) \end{aligned}$$

Inasmuch as the plate thickness is 6 mm (which is greater than 4.6 mm), the situation is a plane strain one. Next, we must determine the  $a/W$  ratio, which is just 16 mm/40 mm = 0.40. From this ratio and using Figure 8.7aW,  $Y = 2.12$ . At this point it becomes necessary to determine the value of the  $Y\sigma\sqrt{\pi a}$  product; if it is greater than  $K_{Ic}$  then fracture will occur. Thus

$$\begin{aligned} Y\sigma\sqrt{\pi a} &= (2.12)(200 \text{ MPa})\sqrt{(\pi)(16 \times 10^{-3} \text{ m})} \\ &= 95.0 \text{ MPa}\sqrt{\text{m}} \quad (86.5 \text{ ksi}\sqrt{\text{in.}}) \end{aligned}$$

Therefore, fracture will occur since this value (95.0 MPa $\sqrt{\text{m}}$ ) is greater than the  $K_{Ic}$  for the steel (60 MPa $\sqrt{\text{m}}$ ).

8.D5W We are to determine the maximum load that may be applied without failure to a thin bar of rectangular cross-section that is loaded in three-point bending per Figure 8.7cW. It first becomes necessary to determine the value of  $Y$  for the given geometry, which is possible using this figure; however, this determination necessitates the computation of  $a/W$  and  $S/W$  ratios as

$$\frac{a}{W} = \frac{0.5 \text{ mm}}{2.5 \text{ mm}} = 0.20$$

$$\frac{S}{W} = \frac{10 \text{ mm}}{2.5 \text{ mm}} = 4$$

From Figure 8.7cW,  $Y = 0.96$  from the  $S/W = 4$  curve and for  $a/W = 0.20$ . Now solving for the applied load  $F$  using the equation also provided in this figure

$$\begin{aligned} F &= \frac{4K_{Ic}W^2B}{3SY\sqrt{\pi a}} \\ &= \frac{4(0.60 \text{ MPa}\sqrt{\text{m}})(2.5 \times 10^{-3} \text{ m})^2(1.5 \times 10^{-3} \text{ m})}{3(10 \times 10^{-3} \text{ m})(0.96)\sqrt{(\pi)(0.5 \times 10^{-3} \text{ m})}} \\ &= 1.97 \times 10^{-5} \text{ MN} = 19.7 \text{ N} \quad (4.69 \text{ lb}_f) \end{aligned}$$



8.D6 (a) This portion of the problem calls for us to rank four polymers relative to critical crack length in the wall of a spherical pressure vessel. In the development of Design Example 8.1, it was noted that critical crack length is proportional to the square of the  $K_{Ic}-\sigma_y$  ratio. Values of  $K_{Ic}$  and  $\sigma_y$  as taken from Tables B.4 and B.5 are tabulated below. (Note: when a range of  $\sigma_y$  or  $K_{Ic}$  values is given, the average value is used.)

Material	$K_{Ic}$ (MPa $\sqrt{m}$ )	$\sigma_y$ (MPa)
Nylon 6,6	2.75	51.7
Polycarbonate	2.2	62.1
Polyethylene terephthlate	5.0	59.3
Polymethyl methacrylate	1.2	63.5

On the basis of these values, the five polymers are ranked per the squares of the  $K_{Ic}-\sigma_y$  ratios as follows:

Material	$\left(\frac{K_{Ic}}{\sigma_y}\right)^2$ (mm)
PET	7.11
Nylon 6,6	2.83
PC	1.26
PMMA	0.36

These values are smaller than those for the metal alloys given in Table 8.2, which range from 0.93 to 43.1 mm.

(b) Relative to the leak-before-break criterion, the  $K_{Ic}^2-\sigma_y$  ratio is used. The five polymers are ranked according to values of this ratio as follows:

Material	$\frac{K_{Ic}^2}{\sigma_y}$ (MPa $\cdot m$ )
PET	0.422
Nylon 6,6	0.146
PC	0.078
PMMA	0.023

These values are all smaller than those for the metal alloys given in Table 8.3, which values range from 1.2 to 11.2 MPa-m.

8.D7W We are asked in this problem to estimate the maximum tensile stress that will yield a fatigue life of  $3.2 \times 10^5$  cycles, given values of  $a_o$ ,  $a_c$ ,  $m$ ,  $A$ , and  $Y$ . Since  $Y$  is independent of crack length we may utilize Equation (8.29W) which, upon integration, takes the form

$$N_f = \frac{1}{A\pi^{m/2}(\Delta\sigma)^m Y^m} \int_{a_o}^{a_c} a^{-m/2} da$$

And for  $m = 4$

$$\begin{aligned} N_f &= \frac{1}{A\pi^2(\Delta\sigma)^4 Y^4} \int_{a_o}^{a_c} a^{-2} da \\ &= -\frac{1}{A\pi^2(\Delta\sigma)^4 Y^4} \left[ \frac{1}{a_c} - \frac{1}{a_o} \right] \end{aligned}$$

Now, solving for  $\Delta\sigma$  from this expression yields

$$\begin{aligned} \Delta\sigma &= \left[ \frac{\frac{1}{a_o} - \frac{1}{a_c}}{N_f A \pi^2 Y^4} \right]^{1/4} \\ &= \left[ \frac{\frac{1}{2.5 \times 10^{-4} \text{ m}} - \frac{1}{5 \times 10^{-3} \text{ m}}}{(3.2 \times 10^5 \text{ cycles})(5 \times 10^{-15})(\pi)^2(2)^4} \right]^{1/4} \\ &= 350 \text{ MPa} \end{aligned}$$

This 350 MPa will be the maximum tensile stress since we can show that the minimum stress is a compressive one--when  $\sigma_{\min}$  is negative,  $\Delta\sigma$  is taken to be  $\sigma_{\max}$ . If we take  $\sigma_{\max} = 350$  MPa, and since  $\sigma_m$  is stipulated in the problem to have a value of 25 MPa, then from Equation (8.14)

$$\sigma_{\min} = 2\sigma_m - \sigma_{\max} = 2(25 \text{ MPa}) - 350 \text{ MPa} = -300 \text{ MPa}$$

Therefore  $\sigma_{\min}$  is negative and we are justified in taking  $\sigma_{\max}$  to be 350 MPa.

8.D8W This problem calls for us to estimate the fatigue life of a large flat plate given that  $\sigma_a = 150$  MPa,  $a_o = 0.75$  mm,  $K_{Ic} = 35 \text{ MPa}\sqrt{\text{m}}$ ,  $m = 2.5$ ,  $A = 2 \times 10^{-12}$ , and  $Y = 1.75$ . It first becomes necessary to compute the critical crack length,  $a_c$ . Employment of Equation (8.7), and assuming a stress level of 150 MPa, since this is the maximum tensile stress, leads to

$$a_c = \frac{1}{\pi} \left( \frac{K_{Ic}}{\sigma Y} \right)^2$$

$$= \frac{1}{\pi} \left( \frac{35 \text{ MPa}\sqrt{\text{m}}}{(150 \text{ MPa})(1.75)} \right)^2 = 5.66 \times 10^{-3} \text{ m}$$

We now want to solve Equation (8.29W) using a lower integration limit,  $a_o$ , of  $7.5 \times 10^{-4}$  m as stated in the problem; also, the value  $\Delta\sigma$  is 150 MPa. Therefore, integration yields for  $N_f$

$$N_f = \frac{1}{A\pi^{m/2}(\Delta\sigma)^m Y^m} \int_{a_o}^{a_c} a^{-m/2} da$$

And for  $m = 2.5$

$$N_f = \frac{1}{A\pi^{2.5/2}(\Delta\sigma)^{2.5} Y^{2.5}} \int_{a_o}^{a_c} a^{-2.5/2} da$$

$$= \frac{1}{A\pi^{1.25}(\Delta\sigma)^{2.5} Y^{2.5}} \left( -\frac{1}{0.25} \right) a^{-0.25} \Bigg|_{a_o}^{a_c}$$

$$= \frac{-4}{(2 \times 10^{-12})\pi^{1.25}(150)^{2.5}(1.75)^{2.5}} \left[ \frac{1}{(5.66 \times 10^{-3})^{0.25}} - \frac{1}{(7.5 \times 10^{-4})^{0.25}} \right]$$

$$= 1.0 \times 10^6 \text{ cycles}$$

8.D9W We are asked in this problem to estimate the critical surface crack length that will yield a fatigue life of  $5 \times 10^6$  cycles, given that  $a_o = 2.0 \times 10^{-2}$  in.,  $\sigma_{\max} = 25,000$  psi,  $m = 3.5$ ,  $A = 1.3 \times 10^{-23}$ , and  $Y = 2.25$ . Since  $Y$  is independent of crack length we may utilize Equation (8.29W) which, upon integration, takes the form

$$N_f = \frac{1}{A\pi^{m/2}(\Delta\sigma)^m Y^m} \int_{a_o}^{a_c} a^{-m/2} da$$

And for  $m = 3.5$

$$N_f = \frac{1}{A\pi^{3.5/2}(\Delta\sigma)^{3.5} Y^{3.5}} \int_{a_o}^{a_c} a^{-3.5/2} da$$

$$= -\frac{1}{A\pi^{1.75}(\Delta\sigma)^{3.5} Y^{3.5}} \left( \frac{1}{-0.75} \right) \left[ (a_c)^{-0.75} - (a_o)^{-0.75} \right]$$

Solving for  $a_c$  from this expression leads to

$$a_c = \left\{ \frac{1}{(a_o)^{-0.75} + \left[ N_f A (-0.75) (\pi)^{1.75} (\Delta\sigma)^{3.5} Y^{3.5} \right]} \right\}^{1/0.75}$$

$$= \left\{ \frac{1}{(2 \times 10^{-2})^{-0.75} + \left[ (5 \times 10^6) (1.3 \times 10^{-23}) (-0.75) (\pi)^{1.75} (25,000)^{3.5} (2.25)^{3.5} \right]} \right\}^{1/0.75}$$

$$= 0.185 \text{ in.}$$

8.D10W (a) For this part of the problem we are asked to calculate, for the plot of Figure 8.17W, values of the **A** and **m** parameters in Equation (8.24W). Taking logarithms of both sides of this expression leads to Equation (8.26bW), that is

$$\log\left(\frac{da}{dN}\right) = m \log \Delta K + \log A$$

Then all we need do is take two values of  $\log (da/dN)$  from the line shown in Figure 8.17W, and their corresponding  $\log (\Delta K)$  values, and then develop two expressions of the above equation and solve simultaneously for **A** and **m**. First of all, for SI units, let us take  $\log (da/dN)_1 = -2$  and  $\log (da/dN)_2 = -4$ ; thus, their corresponding  $\log (\Delta K)$  values are  $\log (\Delta K)_1 = 2.041$  and  $\log (\Delta K)_2 = 1.442$ . Thus, the resulting two equations are as follows:

$$-2 = 2.041 (m) + \log A$$

$$-4 = 1.442 (m) + \log A$$

Simultaneous solution of these expressions leads to **m** = 3.34 and **A** =  $1.52 \times 10^{-9}$ .

Now for Customary U.S. units, let us take  $\log (da/dN)_1 = -4$  and  $\log (da/dN)_2 = -5$ , which lead to  $\log (\Delta K)_1 = 1.9140$  and  $\log (\Delta K)_2 = 1.5530$ . And the two equations are

$$-4 = 1.9140 (m) + \log A$$

$$-5 = 1.5530 (m) + \log A$$

And, the resulting solutions are **m** = 2.77 and **A** =  $5 \times 10^{-10}$ .

(b) And, for this problem part, for this Ni-Mo-V alloy, we are to compute the maximum initial surface crack length to yield a minimum fatigue lifetime of  $3 \times 10^5$  cycles, assuming a critical surface crack length of 1.5 mm, a maximum tensile stress of 30 MPa, and **Y** has a value of 1.25 that is independent of crack length.

Using values of **m** and **A** (for SI units), Equation (8.29W) takes the form

$$N_f = \frac{1}{A\pi^{m/2}(\Delta\sigma)^m Y^m} \int_{a_o}^{a_c} a^{-m/2} da$$

$$N_f = \frac{1}{A\pi^{3.34/2}(\Delta\sigma)^{3.34}Y^{3.34}} \int_{a_o}^{a_c} a^{-3.34/2} da$$

$$= -\frac{1}{A\pi^{1.67}(\Delta\sigma)^{3.34}Y^{3.34}} \left(\frac{1}{-0.67}\right) \left[ (a_c)^{-0.67} - (a_o)^{-0.67} \right]$$

Solving for  $a_o$  from this expression leads to

$$a_o = \left\{ \frac{1}{(a_c)^{-0.67} - \left[ N_f A (-0.67) (\pi)^{1.67} (\Delta\sigma)^{3.34} Y^{3.34} \right]} \right\}^{1/0.67}$$

$$= \left\{ \frac{1}{(1.5 \times 10^{-3})^{-0.67} - \left[ (3.0 \times 10^5) (1.52 \times 10^{-9}) (-0.67) (\pi)^{1.67} (30)^{3.34} (1.25)^{3.34} \right]} \right\}^{1/0.67}$$

$$= 1.1 \times 10^{-4} \text{ m} = 0.11 \text{ mm}$$

8.11W This problem asks that we estimate the fatigue life of a flat plate that has a centrally positioned through-thickness crack, given that  $W = 25 \text{ mm}$ ,  $2a_o = 0.10 \text{ mm}$ ,  $2a_c = 6.0 \text{ mm}$ ,  $m = 4.0$ , and  $A = 6 \times 10^{-12}$ . Furthermore, inasmuch as reverse stress cycling is to be used  $\Delta\sigma = 120 \text{ MPa}$ . For this plate and crack geometry, the parameter  $Y$  in Equation (8.5) is defined by Equation (8.12W), and, therefore, is dependent on crack length. Hence, the equation for  $N_f$  [Equation (8.29W)] now becomes

$$N_f = \frac{1}{A\pi^{m/2}(\Delta\sigma)^m} \int_{a_o}^{a_c} \frac{da}{a^{m/2} \left( \frac{W}{\pi a} \tan \frac{\pi a}{W} \right)^{m/2}}$$

$$= \frac{1}{AW^{m/2}(\Delta\sigma)^m} \int_{a_o}^{a_c} \cot^{m/2} \left( \frac{\pi a}{W} \right) da$$

For  $m = 4$ , this equation takes the form

$$N_f = \frac{1}{AW^2(\Delta\sigma)^4} \int_{a_o}^{a_c} \cot^2\left(\frac{\pi a}{W}\right) da$$

Here, values for  $a_o$  and  $a_c$  are 0.05 mm and 3.0 mm, respectively. Integration of the preceding expression leads to the solution

$$\begin{aligned} N_f &= \frac{1}{AW^2(\Delta\sigma)^4} \left[ -\left(\frac{W}{\pi}\right) \cot\left(\frac{\pi a}{W}\right) - a \right] \Bigg|_{a_o}^{a_c} \\ &= \frac{1}{(6 \times 10^{-12})(25 \times 10^{-3})^2(120)^4} \left[ -\left(\frac{25 \times 10^{-3}}{\pi}\right) \cot\left(\frac{3\pi}{25}\right) - (3 \times 10^{-3}) \right] \\ &\quad + \frac{1}{(6 \times 10^{-12})(25 \times 10^{-3})^2(120)^4} \left[ \left(\frac{25 \times 10^{-3}}{\pi}\right) \cot\left(\frac{0.05\pi}{25}\right) + (0.05 \times 10^{-3}) \right] \\ &= 1.6 \times 10^6 \text{ cycles} \end{aligned}$$

8.D12W For this problem we are given an expression for  $Y(a/W)$  for an edge crack of finite width (Figure 8.7aW), and are asked to estimate the fatigue life for a tension-compression reversed cycle situation given the following:

$$W = 60 \text{ mm (0.06 m)}$$

$$a_o = 5 \text{ mm (} 5 \times 10^{-3} \text{ m)}$$

$$a_c = 12 \text{ mm (} 1.2 \times 10^{-2} \text{ m)}$$

$$m = 3.5$$

$$A = 1.5 \times 10^{-12}$$

Since it is a reversed stress cycle and given that  $\sigma_{\min} = -135$  MPa, it is the case that  $\sigma_{\max} = +135$  MPa; this also means that  $\Delta\sigma$  in Equation (8.29W) is also 135 MPa. Upon substitution the expression for  $Y(a/W)$  [Equation (8.21)] into Equation (8.29W), the fatigue life is equal to the following expression:

$$N_f = \frac{1}{(1.5 \times 10^{-12}) \pi^{1.75} (135)^{3.5}} \int_{a_0}^{a_c} \frac{a^{-1.75} da}{\left[ \frac{1.1 \left(1 - \frac{0.2a}{W}\right)}{\left(1 - \frac{a}{W}\right)^{3/2}} \right]^{3.5}}$$

$N_f$  may now be determined using the **E-Z Solve** equation solver.

After opening **E-Z Solve**, the following text is entered into the workspace of the window that appears:

$$a = t$$

$$T' = 1/K * a^{(-1.75)} / (1.1 * (1 - 0.2 * a / W) / (1 - a / W)^{(3/2)})^{3.5}$$

$$K = 1.5e-12 * \pi^{1.75} * 135^{3.5}$$

$$W = 0.06$$

It is next necessary to click on the calculator icon ("Solve new run") located on the tool bar near the top of the window. At this time another window appears within which the integration limits are specified. In the "IC" window, under the "Independent Variable" column, in the "Start" box is entered "5e-3", which is the lower limit of the integral (i.e.,  $a_0$ ). Furthermore, in the "End" box is entered the upper integration limit ( $a_c$ ), which is "1.2e-2", and in the "# Points" box is entered the value "1".

Under the "Initial Conditions" column, in the "t" box is again entered the lower integration limit--"5e-3"; in the "T" box is left the default value of "0". It is now necessary to click on the "Solve New Run" box at the bottom of this window, at which time the equation solver is engaged. Finally, at the bottom of the first window now appears the data that has been entered as well as the solution. The value for the fatigue life ( $N_f$ ) is given as the nonzero value that appears in the T column--i.e.,  $4.17 \times 10^4$  cycles.

8.D13 This problem asks that we derive an expression for the fatigue life of the spherical tank shown in Figure 8.10 that is alternately pressurized and depressurized between atmospheric pressure and a positive pressure  $p$ . For  $Y$  being independent of crack length  $a$ , Equation (8.29W) takes the form

$$N_f = \frac{1}{A \pi^{m/2} (\Delta \sigma)^m Y^m} \int_{a_0}^{a_c} a^{-m/2} da$$



But  $\Delta\sigma$  is just equal to the expression for  $\sigma$  in Equation (8.8). Making this substitution into the above equation leads to

$$N_f = \frac{1}{A\pi^{m/2}\left(\frac{pr}{2t}\right)^m \gamma^m} \int_{a_o}^{a_c} a^{-m/2} da$$

$$= \frac{2^m t^m}{A\pi^{m/2}(pr)^m \gamma^m} \int_{a_o}^{a_c} a^{-m/2} da$$

This expression must next be integrated which yields

$$N_f = \frac{2^{(m+1)} t^m}{A(2-m)\pi^{m/2}(pr)^m \gamma^m} \left[ a_c^{(1-m/2)} - a_o^{(1-m/2)} \right]$$

which is the desired result.

8.D14W (a) This portion of the problem asks that we compute the maximum tensile load that may be applied to a spring constructed of a  $\frac{1}{4}$  hard 304 stainless steel such that the total deflection is less than 5 mm; there are 10 coils in the spring, whereas, its center-to-center diameter is 15 mm, and the wire diameter is 2.0 mm. The total spring deflection  $\delta_s$  may be determined by combining Equations (8.32W) and (8.33W); solving for the load  $F$  from the combined equation leads to

$$F = \frac{\delta_s d^4 G}{8N_c D^3}$$

However, it is also necessary to determine the value of the shear modulus  $G$ . This is possible using Equation (6.9) and values of the modulus of elasticity (193 GPa) and Poisson's ratio (0.30) as taken from Tables B.2 and B.3 in Appendix B. Thus

$$G = \frac{E}{2(1 + \nu)}$$

$$= \frac{193 \text{ GPa}}{2(1 + 0.30)} = 74.2 \text{ GPa}$$

Substitution of this value and values of the other parameters into the above equation for **F** leads to

$$F = \frac{(5 \times 10^{-3} \text{ m})(2 \times 10^{-3} \text{ m})^4 (74.2 \times 10^9 \text{ N/m}^2)}{(8)(10 \text{ coils})(15 \times 10^{-3} \text{ m})^3}$$

$$= 22.0 \text{ N (5.1 lb}_f\text{)}$$

(b) We are now asked to compute the maximum tensile load that may be applied without any permanent deformation of the spring wire. This requires that we combine Equations (8.30W) and (8.31W), and then solve for **F**. However, it is first necessary to calculate the shear yield strength and substitute it for  $\tau$  in Equation (8.30W). The problem statement stipulates that  $\tau_y = 0.6 \sigma_y$ . From Table B.4 in Appendix B, we note that the tensile yield strength for this alloy in the 1/4 hardened state is 515 MPa; thus  $\tau_y = 309 \text{ MPa}$ . Now, solving for **F** as outlined above

$$F = \frac{\pi \tau_y d^3}{(1.6)(8)(D) \left(\frac{D}{d}\right)^{-0.140}}$$

$$= \frac{\pi (309 \times 10^6 \text{ N/m}^2) (2 \times 10^{-3} \text{ m})^3}{(1.6)(8) (15 \times 10^{-3} \text{ m}) \left(\frac{15 \times 10^{-3} \text{ m}}{2 \times 10^{-3} \text{ m}}\right)^{-0.140}}$$

$$= 53.6 \text{ N (12.5 lb}_f\text{)}$$

8.D15W (a) In this portion of the problem we are asked to select candidate materials for a spring that consists of eight coils and which is not to plastically deform nor experience a deflection of more than 10 mm when a tensile force of 30 N is applied. The coil-to-coil diameter and wire diameter are 12 mm and 1.75 mm, respectively. In addition, we are to assume that  $\tau_y = 0.6 \sigma_y$  and  $\mathbf{G} = 0.4 \mathbf{E}$ . Let us first determine the minimum modulus of elasticity that is required such that the total deflection  $\delta_s$  is less than 10 mm. This requires that we begin by computation of the deflection per coil  $\delta_c$  using Equation (8.33W) as

$$\delta_c = \frac{\delta_s}{N} = \frac{10 \text{ mm}}{8 \text{ coils}} = 1.25 \text{ mm/coil}$$

Now, upon rearrangement of Equation (8.32W) and solving for  $E$ , realizing that  $G = 0.4E$ , we have

$$\begin{aligned} E &= \frac{8FD^3}{(0.4)\delta_c d^4} \\ &= \frac{(8)(30 \text{ N})(12 \times 10^{-3} \text{ m})^3}{(0.4)(1.25 \times 10^{-3} \text{ m})(1.75 \times 10^{-3} \text{ m})^4} \\ &= 88.4 \times 10^9 \text{ N/m}^2 = 88.4 \text{ GPa} \end{aligned}$$

Next, we will calculate the minimum required tensile yield strength by employing Equations (8.36W) and (8.31W). Solving for  $\sigma_y$ , and since  $\tau_y = 0.6\sigma_y$ , the following may be written

$$\begin{aligned} \sigma_y &= \frac{\delta_c(0.4E)d}{(0.6)\pi D^2} \left[ 1.60 \left( \frac{D}{d} \right)^{-0.140} \right] \\ &= \frac{(1.25 \times 10^{-3} \text{ m})(0.4)(88.4 \times 10^9 \text{ N/m}^2)(1.75 \times 10^{-3} \text{ m})}{(0.6)(\pi)(12 \times 10^{-3} \text{ m})^2} \left[ 1.60 \left( \frac{12 \text{ mm}}{1.75 \text{ mm}} \right)^{-0.140} \right] \\ &= 348 \times 10^6 \text{ N/m}^2 = 348 \text{ MPa} \end{aligned}$$

After perusing the database on the CD-ROM or Appendix B in the textbook, it is observed that 30 materials satisfy the two criteria that were determined above (viz.  $E = 88.4 \text{ GPa}$  and  $\sigma_y = 348 \text{ MPa}$ ). These materials are listed below, along with their values of  $E$ ,  $\sigma_y$ , %EL, and relative cost ( $\bar{c}$ ).

Material	Condition	E (GPa)	$\sigma_y$ (MPa)	%EL	$\bar{c}$ (\$/\$)
1020 steel	Plate, CR	207	350	15	1.6
1040 steel	Plate, CR	207	490	12	1.9
1040 steel	Annealed	207	355	30.2	--
1040 steel	Normalized	207	375	28	--
4140 steel	Annealed	207	417	25.7	--
4140 steel	Bar, normalized	207	655	17.7	2.6
4140 steel	Q/T @ 315°C	207	1570	11.5	--
4340 steel	Bar, annealed	207	472	22	3.5
4340 steel	Bar, normalized	207	862	12.2	4.7
4340 steel	Q/T @ 315°C	207	1620	12	--
304 SS	CW, 1/4 hard	193	515	10	4.0
440A SS	Plate, annealed	200	415	20	6.7
440A SS	Q/T @ 315°C	200	1650	5	--
17-7PH SS	Plate, CR	204	1210	1	12.0
17-7PH SS	Ptn. hardened	204	1310	3.5	--
Ductile Iron (80-55-06)	As cast, high prod.	168	379	6	2.4
Ductile Iron (80-55-06)	As cast, low prod.	168	379	6	5.9
Ductile Iron (120-90-02)	Q/T, high prod.	164	621	2	2.4
Ductile Iron (120-90-02)	Q/T, low prod.	164	621	2	5.9
C17200 Cu	Soln. treated/aged	128	905-1205	4-10	51.4
C26000 Cu	CW, H04	110	435	8	6.0
C71500 Cu	CW, H80	150	545	3	12.9
Ti-5Al-2.5Sn	Annealed	110	760	16	157
Ti-6Al-4V	Annealed	114	830	14	132
Ti-6Al-4V	Soln. treated/aged	114	1103	10	132
Molybdenum	Sheet/rod	320	500	25	143
Tungsten	Sheet	400	760	2	111
Tungsten	Rod	400	760	2	166
Inconel 625	Annealed	207	517	42.5	35.0

The student should make his or her own decision as to which material would be most desirable for this application. Consideration should be given to the magnitude of both the elastic modulus and yield strength, in that they should be somewhat greater than the required minima, yet not excessively greater than the minima. Furthermore, the alloy will have to be drawn into a wire, and, thus, the ductility in percent elongation is also a parameter to be considered. And, of course cost is important, as well as the corrosion resistance of the material; corrosion resistant issues for these various alloys are discussed in Chapter 17. And, as called for in the problem statement, the student should justify his or her decision.

8.D16W This problem involves a spring having 10 coils, a coil-to-coil diameter of 0.4 in., which is to deflect no more than 0.80 in. when a tensile load of 12.9 lb<sub>f</sub> is applied. We are asked to calculate the minimum diameter to which a cold-drawn steel wire may be drawn such that plastic deformation of the spring wire will not occur. The spring will plastically deform when the right-hand side of Equation (8.36W) equals the shear yield strength of the cold-drawn wire. Furthermore, the shear yield strength is a function of wire diameter according to Equation (8.22). When we set this expression equal to the right-hand side of Equation (8.36W), the only unknown is the wire diameter, **d**, since, from Equation (8.33W)

$$\begin{aligned}\delta_c &= \frac{\delta_s}{N} = \frac{0.80 \text{ in.}}{10 \text{ coils}} \\ &= 0.080 \text{ in./coil}\end{aligned}$$

Therefore,

$$\tau_y = \frac{63,000}{d^{0.2}} = \frac{\delta_c G d}{\pi D^2} K_w = \frac{\delta_c G d}{\pi D^2} \left[ 1.60 \left( \frac{D}{d} \right)^{-0.140} \right]$$

Now, this expression reduces to

$$\frac{63,000}{d^{0.2}} = \frac{(0.08 \text{ in./coil})(11.5 \times 10^6 \text{ psi})(d)}{\pi(0.40 \text{ in.})^2} \left[ 1.60 \left( \frac{0.40 \text{ in.}}{d} \right)^{-0.140} \right]$$

Or

$$\frac{63,000}{d^{0.2}} = 3.33 \times 10^6 (d)^{1.14}$$

And

$$1.89 \times 10^{-2} = (d)^{1.34}$$

Finally, solving for **d** leads to

$$d = 0.052 \text{ in.}$$

8.D17W This problem involves a spring that is to be constructed from a 4340 steel wire 2 mm in diameter; the design also calls for 12 coils, a coil-to-coil diameter of 12 mm, and the spring deflection is to be no more than 3.5 mm when a tensile load of 27 N is applied. We are asked to specify the heat treatment for this 4340 alloy such that plastic deformation of the spring wire will not occur. The spring will plastically deform when the right-hand side of Equation (8.36W) equals the shear yield strength of wire. However, we must first determine the value of  $\delta_c$  using Equation (8.33W). Thus,

$$\begin{aligned}\delta_c &= \frac{\delta_s}{N} = \frac{3.5 \text{ mm}}{12 \text{ coils}} \\ &= 0.292 \text{ mm/coil}\end{aligned}$$

Now, solving for  $\tau_y$

$$\begin{aligned}\tau_y &= \frac{\delta_c G d}{\pi D^2} K_w = \frac{\delta_c G d}{\pi D^2} \left[ 1.60 \left( \frac{D}{d} \right)^{-0.140} \right] \\ &= \frac{(0.292 \times 10^{-3} \text{ m})(80 \times 10^9 \text{ N/m}^2)(2 \times 10^{-3} \text{ m})}{(\pi)(12 \times 10^{-3} \text{ m})^2} \left[ 1.60 \left( \frac{12 \text{ mm}}{2 \text{ mm}} \right)^{-0.140} \right] \\ &= 129 \times 10^6 \text{ N/m}^2 = 129 \text{ MPa}\end{aligned}$$

It is now possible to solve for the tensile yield strength  $\sigma_y$  as

$$\sigma_y = \frac{\tau_y}{0.6} = \frac{129 \text{ MPa}}{0.6} = 214 \text{ MPa}$$

Thus, it is necessary to heat treat this 4340 steel in order to have a tensile yield strength of 214 MPa. One way this could be accomplished is by first austenitizing the steel, quenching it in oil, and then tempering it. In Figure 10.25 is shown the yield strength as a function of tempering temperature for a 4340 alloy that has been oil quenched. From this plot, in order to achieve a yield strength of 214 MPa, tempering (for 1 h) at approximately 380°C is required.

8.18W This problem asks that we compute the maximum allowable stress level to give a rupture lifetime of 20 days for an S-590 iron component at 923 K. It is first necessary to compute the value of the Larson-Miller parameter as follows:

$$\begin{aligned} T(20 + \log t_r) &= (923 \text{ K})\{20 + \log [(20 \text{ days})(24 \text{ h/day})]\} \\ &= 20.9 \times 10^3 \end{aligned}$$

From the curve in Figure 8.25W, this value of the Larson-Miller parameter corresponds to a stress level of about 280 MPa (40,000 psi).

8.D19W We are asked in this problem to calculate the temperature at which the rupture lifetime is 200 h when an S-590 iron component is subjected to a stress of 55 MPa (8000 psi). From the curve shown in Figure 8.25W, at 55 MPa, the value of the Larson-Miller parameter is  $26.7 \times 10^3$  (K-h). Thus,

$$\begin{aligned} 26.7 \times 10^3 \text{ (K-h)} &= T(20 + \log t_r) \\ &= T[20 + \log(200 \text{ h})] \end{aligned}$$

Or, solving for  $T$  yields  $T = 1197 \text{ K}$  (924°C).

8.20W This problem asks that we determine, for an 18-8 Mo stainless steel, the time to rupture for a component that is subjected to a stress of 100 MPa (14,500 psi) at 600°C (873 K). From Figure

8.45, the value of the Larson-Miller parameter at 100 MPa is about  $22.4 \times 10^3$ , for  $T$  in K and  $t_r$  in h. Therefore,

$$\begin{aligned} 22.4 \times 10^3 &= T (20 + \log t_r) \\ &= 873 (20 + \log t_r) \end{aligned}$$

And, solving for  $t_r$ ,

$$25.77 = 20 + \log t_r$$

which leads to  $t_r = 4.6 \times 10^5 \text{ h} = 52 \text{ yr}$ .

8.D21W We are asked in this problem to calculate the stress levels at which the rupture lifetime will be 1 year and 15 years when an 18-8 Mo stainless steel component is subjected to a temperature of  $650^\circ\text{C}$  (923 K). It first becomes necessary to calculate the value of the Larson-Miller parameter for each time. The values of  $t_r$  corresponding to 1 and 15 years are  $8.76 \times 10^3 \text{ h}$  and  $1.31 \times 10^5 \text{ h}$ , respectively. Hence, for a lifetime of 1 year

$$T (20 + \log t_r) = 923 [20 + \log (8.76 \times 10^3)] = 22.10 \times 10^3$$

And for  $t_r = 15$  years

$$T (20 + \log t_r) = 923 [20 + \log (1.31 \times 10^5)] = 23.18 \times 10^3$$

Using the curve shown in Figure 8.45, the stress values corresponding to the one- and fifteen-year lifetimes are approximately 110 MPa (16,000 psi) and 80 MPa (11,600 psi), respectively.

8.D22W Each student or group of students is to submit their own report on a failure analysis investigation that was conducted.



## CHAPTER 9

### PHASE DIAGRAMS

#### PROBLEM SOLUTIONS

- 9.1 Three variables that determine the microstructure of an alloy are 1) the alloying elements present, 2) the concentrations of these alloying elements, and 3) the heat treatment of the alloy.
- 9.2 In order for a system to exist in a state of equilibrium the free energy must be a minimum for some specified combination of temperature, pressure, and composition.
- 9.3 Diffusion occurs during the development of microstructure in the absence of a concentration gradient because the driving force is different than for steady state diffusion as described in Section 5.3; for the development of microstructure, the driving force is a decrease in free energy.
- 9.4 For the condition of phase equilibrium the free energy is a minimum, the system is completely stable meaning that over time the phase characteristics are constant. For metastability, the system is not at equilibrium, and there are very slight (and often imperceptible) changes of the phase characteristics with time.
- 9.5 This problem asks that we cite the phase or phases present for several alloys at specified temperatures.

(a) For an alloy composed of 15 wt% Sn-85 wt% Pb and at 100°C, from Figure 9.7,  $\alpha$  and  $\beta$  phases are present, and

$$C_{\alpha} = 5 \text{ wt\% Sn-95 wt\% Pb}$$

$$C_{\beta} = 98 \text{ wt\% Sn-2 wt\% Pb}$$

(b) For an alloy composed of 25 wt% Pb-75 wt% Mg and at 425°C, from Figure 9.18, only the  $\alpha$  phase is present; its composition is 25 wt% Pb-75 wt% Mg.

(c) For an alloy composed of 85 wt% Ag-15 wt% Cu and at 800°C, from Figure 9.6,  $\beta$  and liquid phases are present, and

$$C_{\beta} = 92 \text{ wt\% Ag-8 wt\% Cu}$$

$$C_L = 77 \text{ wt\% Ag-23 wt\% Cu}$$

(d) For an alloy composed of 55 wt% Zn-45 wt% Cu and at 600°C, from Figure 9.17,  $\beta$  and  $\gamma$  phases are present, and

$$C_{\beta} = 51 \text{ wt\% Zn-49 wt\% Cu}$$

$$C_{\gamma} = 58 \text{ wt\% Zn-42 wt\% Cu}$$

(e) For an alloy composed of 1.25 kg Sn and 14 kg Pb and at 200°C, we must first determine the Sn and Pb concentrations, as

$$C_{\text{Sn}} = \frac{1.25 \text{ kg}}{1.25 \text{ kg} + 14 \text{ kg}} \times 100 = 8.2 \text{ wt\%}$$

$$C_{\text{Pb}} = \frac{14 \text{ kg}}{1.25 \text{ kg} + 14 \text{ kg}} \times 100 = 91.8 \text{ wt\%}$$

From Figure 9.7, only the  $\alpha$  phase is present; its composition is 8.2 wt% Sn-91.8 wt% Pb.

(f) For an alloy composed of 7.6 lb<sub>m</sub> Cu and 114.4 lb<sub>m</sub> Zn and at 600°C, we must first determine the Cu and Zn concentrations, as

$$C_{\text{Cu}} = \frac{7.6 \text{ lb}_m}{7.6 \text{ lb}_m + 114.4 \text{ lb}_m} \times 100 = 5.0 \text{ wt\%}$$

$$C_{\text{Zn}} = \frac{114.4 \text{ lb}_m}{7.6 \text{ lb}_m + 114.4 \text{ lb}_m} \times 100 = 95.0 \text{ wt\%}$$

From Figure 9.17, only the L phase is present; its composition is 95.0 wt% Zn-5.0 wt% Cu

(g) For an alloy composed of 21.7 mol Mg and 35.4 mol Pb and at 350°C, it is first necessary to determine the Mg and Pb concentrations, which we will do in weight percent as follows:

$$m_{\text{Pb}}' = n_{\text{m}_{\text{Pb}}} A_{\text{Pb}} = (35.4 \text{ mol})(207.2 \text{ g/mol}) = 7335 \text{ g}$$

$$m_{\text{Mg}}' = n_{\text{m}_{\text{Mg}}} A_{\text{Mg}} = (21.7 \text{ mol})(24.3 \text{ g/mol}) = 527 \text{ g}$$

$$C_{\text{Pb}} = \frac{7335 \text{ g}}{7335 \text{ g} + 527 \text{ g}} \times 100 = 93 \text{ wt\%}$$

$$C_{\text{Mg}} = 100 \text{ wt\%} - 93 \text{ wt\%} = 7 \text{ wt\%}$$

From Figure 9.18, L and Mg<sub>2</sub>Pb phases are present, and

$$C_{\text{L}} = 94 \text{ wt\% Pb} - 6 \text{ wt\% Mg}$$

$$C_{\text{Mg}_2\text{Pb}} = 81 \text{ wt\% Pb} - 19 \text{ wt\% Mg}$$

(h) For an alloy composed of 4.2 mol Cu and 1.1 mol Ag and at 900°C, it is first necessary to determine the Cu and Ag concentrations, which we will do in weight percent as follows:

$$m_{\text{Cu}} = n_{m_{\text{Cu}}} A_{\text{Cu}} = (4.2 \text{ mol})(63.55 \text{ g/mol}) = 266.9 \text{ g}$$

$$m_{\text{Ag}} = n_{m_{\text{Ag}}} A_{\text{Ag}} = (1.1 \text{ mol})(107.87 \text{ g/mol}) = 118.7 \text{ g}$$

$$C_{\text{Cu}} = \frac{266.9 \text{ g}}{266.9 \text{ g} + 118.7 \text{ g}} \times 100 = 69.2 \text{ wt\%}$$

$$C_{\text{Ag}} = \frac{118.7 \text{ g}}{266.9 \text{ g} + 118.7 \text{ g}} \times 100 = 30.8 \text{ wt\%}$$

From Figure 9.6, α and liquid phases are present; and

$$C_{\alpha} = 8 \text{ wt\% Ag-92 w\% Cu}$$

$$C_{\text{L}} = 45 \text{ wt\% Ag-55 wt\% Cu}$$

9.6 This problem asks us to determine the phases present and their concentrations at several temperatures, as an alloy of composition 52 wt% Zn- 48 wt% Cu is cooled. From Figure 9.17:

At 1000°C, a liquid phase is present;  $W_{\text{L}} = 1.0$

At 800°C, the β phase is present, and  $W_{\beta} = 1.0$

At 500°C, β and γ phases are present, and

$$W_{\gamma} = \frac{C_o - C_{\beta}}{C_{\gamma} - C_{\beta}} = \frac{52 - 49}{58 - 49} = 0.33$$

$$W_{\beta} = 1.00 - 0.33 = 0.67$$

At 300°C, the  $\beta'$  and  $\gamma$  phases are present, and

$$W_{\beta'} = \frac{C_{\gamma} - C_o}{C_{\gamma} - C_{\beta'}} = \frac{59 - 52}{59 - 50} = 0.78$$

$$W_{\gamma} = 1.00 - 0.78 = 0.22$$

9.7 This problem asks that we determine the phase mass fractions for the alloys and temperatures in Problem 9.5.

(a)

$$W_{\alpha} = \frac{C_{\beta} - C_o}{C_{\beta} - C_{\alpha}} = \frac{98 - 15}{98 - 5} = 0.89$$

$$W_{\beta} = \frac{C_o - C_{\alpha}}{C_{\beta} - C_{\alpha}} = \frac{15 - 5}{98 - 5} = 0.11$$

(b)  $W_{\alpha} = 1.0$

(c)

$$W_{\beta} = \frac{C_o - C_L}{C_{\beta} - C_L} = \frac{85 - 77}{92 - 77} = 0.53$$

$$W_L = \frac{C_{\beta} - C_o}{C_{\beta} - C_L} = \frac{92 - 85}{92 - 77} = 0.47$$

(d)

$$W_{\beta} = \frac{C_{\gamma} - C_o}{C_{\gamma} - C_{\beta}} = \frac{58 - 55}{58 - 51} = 0.43$$

$$W_\gamma = \frac{C_o - C_\beta}{C_\gamma - C_\beta} = \frac{55 - 51}{58 - 51} = 0.57$$

(e)  $W_\alpha = 1.0$

(f)  $W_L = 1.0$

(g)

$$W_{Mg_2Pb} = \frac{C_L - C_o}{C_L - C_{Mg_2Pb}} = \frac{94 - 93}{94 - 81} = 0.08$$

$$W_L = \frac{C_o - C_{Mg_2Pb}}{C_L - C_{Mg_2Pb}} = \frac{93 - 81}{94 - 81} = 0.92$$

(h)

$$W_\alpha = \frac{C_L - C_o}{C_L - C_\alpha} = \frac{45 - 30.8}{45 - 8} = 0.38$$

$$W_L = \frac{C_o - C_\alpha}{C_L - C_\alpha} = \frac{30.8 - 8}{45 - 8} = 0.62$$

9.8 (a) In this problem we are asked to derive Equation (9.6a), which is used to convert from phase weight fraction to phase volume fraction. Volume fraction of phase  $\alpha$ ,  $V_\alpha$ , is defined by Equation

(9.5) as

$$V_\alpha = \frac{v_\alpha}{v_\alpha + v_\beta} \quad (9.S1)$$

where  $v_\alpha$  and  $v_\alpha$  are the volumes of the respective phases in the alloy. Furthermore, the density of each phase is equal to the ratio of its mass and volume, or upon rearrangement

$$v_\alpha = \frac{m_\alpha}{\rho_\alpha} \quad (9.S2a)$$

$$v_{\beta} = \frac{m_{\beta}}{\rho_{\beta}} \quad (9.S2b)$$

Substitution of these expressions into Equation (9.S1) leads to

$$V_{\alpha} = \frac{\frac{m_{\alpha}}{\rho_{\alpha}}}{\frac{m_{\alpha}}{\rho_{\alpha}} + \frac{m_{\beta}}{\rho_{\beta}}} \quad (9.S3)$$

in which  $m$ 's and  $\rho$ 's denote masses and densities, respectively. Now, the mass fractions of the  $\alpha$  and  $\beta$  phases (i.e.,  $W_{\alpha}$  and  $W_{\beta}$ ) are defined in terms of the phase masses as

$$W_{\alpha} = \frac{m_{\alpha}}{m_{\alpha} + m_{\beta}} \quad (9.S4a)$$

$$W_{\beta} = \frac{m_{\beta}}{m_{\alpha} + m_{\beta}} \quad (9.S4b)$$

Which, upon rearrangement yield

$$m_{\alpha} = W_{\alpha} (m_{\alpha} + m_{\beta}) \quad (9.S5a)$$

$$m_{\beta} = W_{\beta} (m_{\alpha} + m_{\beta}) \quad (9.S5b)$$

Incorporation of these relationships into Equation (9.S3) leads to the desired expression

$$V_{\alpha} = \frac{\frac{W_{\alpha}}{\rho_{\alpha}}}{\frac{W_{\alpha}}{\rho_{\alpha}} + \frac{W_{\beta}}{\rho_{\beta}}} \quad (9.S6)$$

- (b) For this portion of the problem we are asked to derive Equation (9.7a), which is used to convert from phase volume fraction to phase mass fraction. Mass fraction of the  $\alpha$  phase,  $W_{\alpha}$ , is defined as

$$W_{\alpha} = \frac{m_{\alpha}}{m_{\alpha} + m_{\beta}} \quad (9.S7)$$

From Equations (9.S2a) and (9.S2b)

$$m_{\alpha} = v_{\alpha}\rho_{\alpha} \quad (9.S8a)$$

$$m_{\beta} = v_{\beta}\rho_{\beta} \quad (9.S8b)$$

Substitution of these expressions into Equation (9.S7) yields

$$W_{\alpha} = \frac{v_{\alpha}\rho_{\alpha}}{v_{\alpha}\rho_{\alpha} + v_{\beta}\rho_{\beta}} \quad (9.S9)$$

From Equation (9.S1) and its equivalent for  $V_{\beta}$  the following may be written

$$v_{\alpha} = V_{\alpha}(v_{\alpha} + v_{\beta}) \quad (9.S10a)$$

$$v_{\beta} = V_{\beta}(v_{\alpha} + v_{\beta}) \quad (9.S10b)$$

Substitution of Equations (9.S10a) and (9.S10b) into Equation (9.S9) yields the desired expression

$$W_{\alpha} = \frac{V_{\alpha}\rho_{\alpha}}{V_{\alpha}\rho_{\alpha} + V_{\beta}\rho_{\beta}} \quad (9.S11)$$

9.9 This problem asks that we determine the phase volume fractions for the alloys and temperatures in Problems 9.5a, b, and d. This is accomplished by using the technique illustrated in Example Problem 9.3, and the results of Problems 9.5 and 9.7.

(a) This is a Sn-Pb alloy at 100°C, wherein

$$C_{\alpha} = 5 \text{ wt\% Sn-95 wt\% Pb}$$

$$C_{\beta} = 98 \text{ wt\% Sn-2 wt\% Pb}$$

$$W_{\alpha} = 0.89$$

$$W_{\beta} = 0.11$$

$$\rho_{\text{Sn}} = 7.29 \text{ g/cm}^3$$

$$\rho_{\text{Pb}} = 11.27 \text{ g/cm}^3$$

Using these data it is first necessary to compute the densities of the  $\alpha$  and  $\beta$  phases using Equation (4.10a). Thus

$$\begin{aligned} \rho_{\alpha} &= \frac{100}{\frac{C_{\text{Sn}(\alpha)}}{\rho_{\text{Sn}}} + \frac{C_{\text{Pb}(\alpha)}}{\rho_{\text{Pb}}}} \\ &= \frac{100}{\frac{5}{7.29 \text{ g/cm}^3} + \frac{95}{11.27 \text{ g/cm}^3}} = 10.97 \text{ g/cm}^3 \end{aligned}$$

$$\begin{aligned} \rho_{\beta} &= \frac{100}{\frac{C_{\text{Sn}(\beta)}}{\rho_{\text{Sn}}} + \frac{C_{\text{Pb}(\beta)}}{\rho_{\text{Pb}}}} \\ &= \frac{100}{\frac{98}{7.29 \text{ g/cm}^3} + \frac{2}{11.27 \text{ g/cm}^3}} = 7.34 \text{ g/cm}^3 \end{aligned}$$

Now we may determine the  $V_{\alpha}$  and  $V_{\beta}$  values using Equation 9.6. Thus,

$$\begin{aligned} V_{\alpha} &= \frac{\frac{W_{\alpha}}{\rho_{\alpha}}}{\frac{W_{\alpha}}{\rho_{\alpha}} + \frac{W_{\beta}}{\rho_{\beta}}} \\ &= \frac{\frac{0.89}{10.97 \text{ g/cm}^3}}{\frac{0.89}{10.97 \text{ g/cm}^3} + \frac{0.11}{7.34 \text{ g/cm}^3}} = 0.84 \end{aligned}$$



$$V_{\beta} = \frac{\frac{W_{\beta}}{\rho_{\beta}}}{\frac{W_{\alpha}}{\rho_{\alpha}} + \frac{W_{\beta}}{\rho_{\beta}}}$$

$$= \frac{\frac{0.11}{7.34 \text{ g/cm}^3}}{\frac{0.89}{10.97 \text{ g/cm}^3} + \frac{0.11}{7.34 \text{ g/cm}^3}} = 0.16$$

(b) This is a Pb-Mg alloy at 425°C, wherein only the  $\alpha$  phase is present. Therefore,  $V_{\alpha} = 1.0$ .

(d) This is a Zn-Cu alloy at 600°C, wherein

$$C_{\beta} = 51 \text{ wt\% Zn-49 wt\% Cu}$$

$$C_{\gamma} = 58 \text{ wt\% Zn-42 wt\% Cu}$$

$$W_{\beta} = 0.43$$

$$W_{\gamma} = 0.57$$

$$\rho_{\text{Zn}} = 6.67 \text{ g/cm}^3$$

$$\rho_{\text{Cu}} = 8.68 \text{ g/cm}^3$$

Using this data it is first necessary to compute the densities of the  $\beta$  and  $\gamma$  phases. Thus

$$\rho_{\beta} = \frac{100}{\frac{C_{\text{Zn}(\beta)}}{\rho_{\text{Zn}}} + \frac{C_{\text{Cu}(\beta)}}{\rho_{\text{Cu}}}}$$

$$= \frac{100}{\frac{51}{6.67 \text{ g/cm}^3} + \frac{49}{8.68 \text{ g/cm}^3}} = 7.52 \text{ g/cm}^3$$

$$\rho_{\gamma} = \frac{100}{\frac{C_{\text{Zn}(\gamma)}}{\rho_{\text{Zn}}} + \frac{C_{\text{Cu}(\gamma)}}{\rho_{\text{Cu}}}}$$

$$= \frac{100}{\frac{58}{6.67 \text{ g/cm}^3} + \frac{42}{8.68 \text{ g/cm}^3}} = 7.39 \text{ g/cm}^3$$

Now we may determine the  $V_\beta$  and  $V_\gamma$  values using Equation (9.6). Thus,

$$V_\beta = \frac{\frac{W_\beta}{\rho_\beta}}{\frac{W_\beta}{\rho_\beta} + \frac{W_\gamma}{\rho_\gamma}}$$

$$= \frac{\frac{0.43}{7.52 \text{ g/cm}^3}}{\frac{0.43}{7.52 \text{ g/cm}^3} + \frac{0.57}{7.39 \text{ g/cm}^3}} = 0.43$$

$$V_\gamma = \frac{\frac{W_\gamma}{\rho_\gamma}}{\frac{W_\beta}{\rho_\beta} + \frac{W_\gamma}{\rho_\gamma}}$$

$$= \frac{\frac{0.57}{7.39 \text{ g/cm}^3}}{\frac{0.43}{7.52 \text{ g/cm}^3} + \frac{0.57}{7.39 \text{ g/cm}^3}} = 0.57$$

9.10 (a) Spreading salt on ice will lower the melting temperature, since the liquidus line decreases from  $0^\circ\text{C}$  to the eutectic temperature at about  $-21^\circ\text{C}$ . Thus, ice at a temperature below  $0^\circ\text{C}$  (and above  $-21^\circ\text{C}$ ) can be made to form a liquid phase by the addition of salt.

(b) We are asked to compute the concentration of salt necessary to have a 50% ice-50% brine solution at  $-10^\circ\text{C}$  ( $14^\circ\text{F}$ ). At  $-10^\circ\text{C}$ ,

$$C_{\text{ice}} = 0 \text{ wt\% NaCl-100 wt\% H}_2\text{O}$$

$$C_{\text{brine}} = 13 \text{ wt\% NaCl-87 wt\% H}_2\text{O}$$

Thus,

$$W_{\text{ice}} = 0.5 = \frac{C_{\text{brine}} - C_o}{C_{\text{brine}} - C_{\text{ice}}} = \frac{13 - C_o}{13 - 0}$$

Solving for  $C_o$  (the concentration of salt) yields a value of 6.5 wt% NaCl-93.5 wt%  $H_2O$ .

9.11 (a) This part of the problem calls for us to cite the temperature to which a 90 wt% Pb-10 wt% Sn alloy must be heated in order to have 50% liquid. Probably the easiest way to solve this problem is by trial and error--that is, moving vertically at the given composition, through the  $\alpha + L$  region until the tie-line lengths on both sides of the given composition are the same (Figure 9.7). This occurs at approximately 300°C (570°F).

(b) We can also produce a 50% liquid solution at 250°C, by adding Sn to the alloy. At 250°C and within the  $\alpha + L$  phase region

$$C_{\alpha} = 13 \text{ wt\% Sn-87 wt\% Pb}$$

$$C_L = 39 \text{ wt\% Sn-61 wt\% Pb}$$

Let  $C_o$  be the new alloy composition to give  $W_{\alpha} = W_L = 0.5$ . Then,

$$W_{\alpha} = 0.5 = \frac{C_L - C_o}{C_L - C_{\alpha}} = \frac{39 - C_o}{39 - 13}$$

And solving for  $C_o$  gives 26 wt% Sn. Now, let  $m_{\text{Sn}}$  be the mass of Sn added to the alloy to achieve this new composition. The amount of Sn in the original alloy is

$$(0.10)(1.5 \text{ kg}) = 0.15 \text{ kg}$$

Then, using a modified form of Equation (4.3)

$$\left[ \frac{0.15 \text{ kg} + m_{\text{Sn}}}{1.5 \text{ kg} + m_{\text{Sn}}} \right] \times 100 = 26$$

And, solving for  $m_{\text{Sn}}$  yields  $m_{\text{Sn}} = 0.324 \text{ kg}$ .

9.12 (a) We are asked to determine how much sugar will dissolve in 1000 g of water at 80°C. From the solubility limit curve in Figure 9.1, at 80°C the maximum concentration of sugar in the syrup is about 74 wt%. It is now possible to calculate the mass of sugar using Equation (4.3) as

$$C_{\text{sugar}}(\text{wt}\%) = \frac{m_{\text{sugar}}}{m_{\text{sugar}} + m_{\text{water}}} \times 100$$

$$74 \text{ wt}\% = \frac{m_{\text{sugar}}}{m_{\text{sugar}} + 1000 \text{ g}} \times 100$$

Solving for  $m_{\text{sugar}}$  yields  $m_{\text{sugar}} = 2846 \text{ g}$

(b) Again using this same plot, at 20°C the solubility limit (or the concentration of the saturated solution) is about 64 wt% sugar.

(c) The mass of sugar in this saturated solution at 20°C ( $m_{\text{sugar}}'$ ) may also be calculated using Equation (4.3) as follows:

$$64 \text{ wt}\% = \frac{m_{\text{sugar}}'}{m_{\text{sugar}}' + 1000 \text{ g}} \times 100$$

which yields a value for  $m_{\text{sugar}}'$  of 1778 g. Subtracting the latter from the former of these sugar concentrations yields the amount of sugar that precipitated out of the solution upon cooling  $m_{\text{sugar}}''$ ; that is

$$m_{\text{sugar}}'' = m_{\text{sugar}} - m_{\text{sugar}}' = 2846 \text{ g} - 1778 \text{ g} = 1068 \text{ g}$$

9.13 This problem asks us to consider a specimen of ice I which is at -10°C and 1 atm pressure.

(a) In order to determine the pressure at which melting occurs at this temperature, we move vertically at this temperature until we cross the Ice I-Liquid phase boundary of Figure 9.33. This occurs at approximately 570 atm; thus the pressure of the specimen must be raised from 1 to 570 atm.

(b) In order to determine the pressure at which sublimation occurs at this temperature, we move vertically downward from 1 atm until we cross the Ice I-Vapor phase boundary of Figure 9.33. This intersection occurs at approximately 0.0023 atm.

9.14 The melting and boiling temperatures for ice I at a pressure of 0.01 atm may be determined by moving horizontally across the pressure-temperature diagram of Figure 9.33 at this pressure. The temperature corresponding to the intersection of the Ice I-Liquid phase boundary is the melting temperature, which is approximately 1°C. On the other hand, the boiling temperature is at the intersection of the horizontal line with the Liquid-Vapor phase boundary--approximately 28°C.

9.15 (a) This portion of the problem asks that we calculate, for a Pb-Mg alloy, the mass of lead in 7.5 kg of the solid  $\alpha$  phase at 300°C just below the solubility limit. From Figure 9.18, the composition of an alloy at this temperature is about 17 wt% Pb. Therefore, the mass of Pb in the alloy is just  $(0.17)(7.5 \text{ kg}) = 1.3 \text{ kg}$ .

(b) At 400°C, the solubility limit of the  $\alpha$  phase increases to approximately 32 wt% Pb. In order to determine the additional amount of Pb that may be added ( $m_{\text{Pb}'}$ ), we utilize a modified form of Equation (4.3) as

$$C_{\text{Pb}} = 32 \text{ wt\%} = \frac{1.3 \text{ kg} + m_{\text{Pb}'}}{7.5 \text{ kg} + m_{\text{Pb}'}} \times 100$$

Solving for  $m_{\text{Pb}'}$ , yields  $m_{\text{Pb}'} = 1.62 \text{ kg}$ .

9.16 (a) Coring is the phenomenon whereby concentration gradients exist across grains in polycrystalline alloys, with higher concentrations of the component having the lower melting temperature at the grain boundaries. It occurs, during solidification, as a consequence of cooling rates that are too rapid to allow for the maintenance of the equilibrium composition of the solid phase.

(b) One undesirable consequence of a cored structure is that, upon heating, the grain boundary regions will melt first and at a temperature below the equilibrium phase boundary from the phase diagram; this melting results in a loss in mechanical integrity of the alloy.

9.17 This problem asks if a noncold-worked Cu-Ni solid solution alloy is possible having a minimum tensile strength of 380 MPa (55,000 psi) and also a ductility of at least 45%EL. From Figure 9.5a, a tensile strength greater than 380 MPa is possible for compositions between about 34 and 87 wt% Ni. On the other hand, according to Figure 9.5b, ductilities greater than 45%EL exist for compositions less than about 7 wt% and greater than about 71 wt% Ni. Therefore, the stipulated criteria are met for all compositions between 71 and 87 wt% Ni.

9.18 It is **not possible** to have a Cu-Ni alloy, which at equilibrium, consists of a liquid phase of composition 20 wt% Ni-80 wt% Cu and an  $\alpha$  phase of composition 37 wt% Ni-63 wt% Cu. From Figure 9.2a, a single tie line does not exist within the  $\alpha + \text{L}$  region that intersects the phase boundaries at the given compositions. At 20 wt% Ni, the  $\text{L}-(\alpha + \text{L})$  phase boundary is at about 1200°C, whereas at 37 wt% Ni the  $(\text{L} + \alpha)-\alpha$  phase boundary is at about 1230°C.

- 9.19 It is **possible** to have a Cu-Ag alloy, which at equilibrium consists of an  $\alpha$  phase of composition 5 wt% Ag-95 wt% Cu and a  $\beta$  phase of composition 95 wt% Ag-5 wt% Cu. From Figure 9.6 a horizontal tie can be constructed across the  $\alpha + \beta$  region at 690°C which intersects the  $\alpha$ -( $\alpha + \beta$ ) phase boundary at 5 wt% Ag, and also the ( $\alpha + \beta$ )- $\beta$  phase boundary at 95 wt% Ag.
- 9.20 Upon heating a lead-tin alloy of composition 30 wt% Sn-70 wt% Pb from 150°C and utilizing Figure 9.7:
- the first liquid forms at the temperature at which a vertical line at this composition intersects the eutectic isotherm--i.e., at 183°C;
  - the composition of this liquid phase corresponds to the intersection with the ( $\alpha + L$ )-L phase boundary, of a tie line constructed across the  $\alpha + L$  phase region just above this eutectic isotherm--i.e.,  $C_L = 61.9$  wt% Sn;
  - complete melting of the alloy occurs at the intersection of this same vertical line at 30 wt% Sn with the ( $\alpha + L$ )-L phase boundary--i.e., at about 260°C;
  - the composition of the last solid remaining prior to complete melting corresponds to the intersection with  $\alpha$ -( $\alpha + L$ ) phase boundary, of the tie line constructed across the  $\alpha + L$  phase region at 260°C--i.e.,  $C_\alpha$  is about 13 wt% Sn.
- 9.21 Upon cooling a 50 wt% Ni-50 wt% Cu alloy from 1400°C and utilizing Figure 9.2a:
- The first solid phase forms at the temperature at which a vertical line at this composition intersects the L-( $\alpha + L$ ) phase boundary--i.e., at about 1320°C;
  - The composition of this solid phase corresponds to the intersection with the L-( $\alpha + L$ ) phase boundary, of a tie line constructed across the  $\alpha + L$  phase region at 1320°C--i.e.,  $C_\alpha = 62$  wt% Ni-38 wt% Cu;
  - Complete solidification of the alloy occurs at the intersection of this same vertical line at 50 wt% Ni with the ( $\alpha + L$ )- $\alpha$  phase boundary--i.e., at about 1270°C;
  - The composition of the last liquid phase remaining prior to complete solidification corresponds to the intersection with the L-( $\alpha + L$ ) boundary, of the tie line constructed across the  $\alpha + L$  phase region at 1270°C--i.e.,  $C_L$  is about 37 wt% Ni-63 wt% Cu.
- 9.22 (a) In order to determine the temperature of a 65 wt% Ni-35 wt% Cu alloy for which  $\alpha$  and liquid phases are present with the  $\alpha$  phase of composition 70 wt% Ni, we need to construct a tie line across the  $\alpha + L$  phase region of Figure 9.2a that intersects the solidus line at 70 wt% Ni; this is possible at about 1340°C.
- (b) The composition of the liquid phase at this temperature is determined from the intersection of this same tie line with liquidus line, which corresponds to about 59 wt% Ni.

(c) The mass fractions of the two phases are determined using the lever rule, Equations (9.1) and (9.2) with  $C_o = 65$  wt% Ni,  $C_L = 59$  wt% Ni, and  $C_\alpha = 70$  wt% Ni, as

$$W_\alpha = \frac{C_o - C_L}{C_\alpha - C_L} = \frac{65 - 59}{70 - 59} = 0.55$$

$$W_L = \frac{C_\alpha - C_o}{C_\alpha - C_L} = \frac{70 - 65}{70 - 59} = 0.45$$

9.23 The copper-gold phase diagram is constructed below.

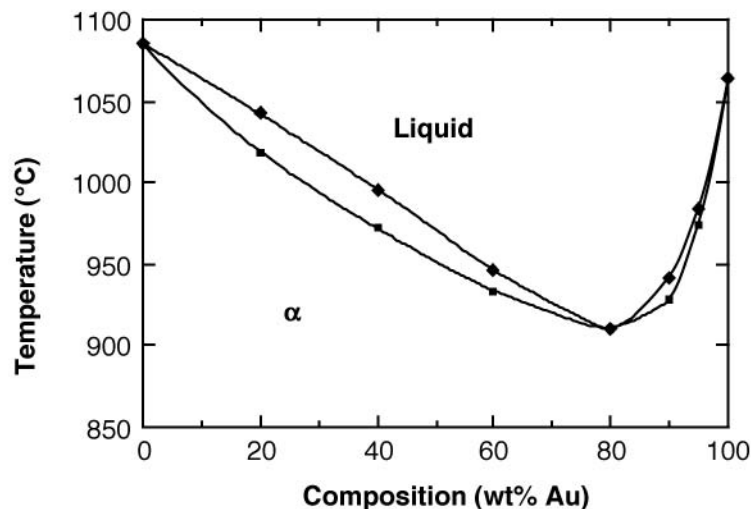

9.24 (a) We are given that the mass fractions of  $\alpha$  and liquid phases are both 0.5 for a 40 wt% Pb-60 wt% Mg alloy and asked to estimate the temperature of the alloy. Using the appropriate phase diagram, Figure 9.18, by trial and error with a ruler, a tie line within the  $\alpha + L$  phase region that is divided in half for an alloy of this composition exists at about 540°C.

(b) We are now asked to determine the compositions of the two phases. This is accomplished by noting the intersections of this tie line with both the solidus and liquidus lines. From these intersections,  $C_\alpha = 26$  wt% Pb, and  $C_L = 54$  wt% Pb.

9.25 The problem is to solve for compositions at the phase boundaries for both  $\alpha$  and  $\beta$  phases (i.e.,  $C_\alpha$  and  $C_\beta$ ). We may set up two independent lever rule expressions, one for each composition, in terms of  $C_\alpha$  and  $C_\beta$  as follows:

$$W_{\alpha 1} = 0.57 = \frac{C_{\beta} - C_{O1}}{C_{\beta} - C_{\alpha}} = \frac{C_{\beta} - 60}{C_{\beta} - C_{\alpha}}$$

$$W_{\alpha 2} = 0.14 = \frac{C_{\beta} - C_{O2}}{C_{\beta} - C_{\alpha}} = \frac{C_{\beta} - 30}{C_{\beta} - C_{\alpha}}$$

In these expressions, compositions are given in weight percent A. Solving for  $C_{\alpha}$  and  $C_{\beta}$  from these equations, yield

$$C_{\alpha} = 90 \text{ (or 90 wt\% A-10 wt\% B)}$$

$$C_{\beta} = 20.2 \text{ (or 20.2 wt\% A-79.8 wt\% B)}$$

9.26 For this problem

$$C_O = 55 \text{ (or 55 wt\% B-45 wt\% A)}$$

$$C_{\beta} = 90 \text{ (or 90 wt\% B-10 wt\% A)}$$

$$W_{\alpha} = W_{\beta} = 0.5$$

If we set up the lever rule expression for  $W_{\alpha}$

$$W_{\alpha} = 0.5 = \frac{C_{\beta} - C_O}{C_{\beta} - C_{\alpha}} = \frac{90 - 55}{90 - C_{\alpha}}$$

And solving for  $C_{\alpha}$

$$C_{\alpha} = 20 \text{ (or 20 wt\% B-80 wt\% A)}$$

9.27 Yes, it is possible to have a Cu-Ag alloy of composition 20 wt% Ag-80 wt% Cu which consists of mass fractions  $W_{\alpha} = 0.80$  and  $W_L = 0.20$ . Using the appropriate phase diagram, Figure 9.6, by trial and error with a ruler, the tie-line segments within the  $\alpha + L$  phase region are proportioned such that

$$W_{\alpha} = 0.8 = \frac{C_L - C_O}{C_L - C_{\alpha}}$$



for  $C_o = 20$  wt% Ag. This occurs at about  $800^\circ\text{C}$ .

- 9.28 It is **not possible** to have a 50 wt% Pb-50 wt% Mg alloy which has masses of 5.13 kg and 0.57 kg for the  $\alpha$  and  $\text{Mg}_2\text{Pb}$  phases, respectively. In order to demonstrate this, it is first necessary to determine the mass fraction of each phase as follows:

$$W_\alpha = \frac{m_\alpha}{m_\alpha + m_{\text{Mg}_2\text{Pb}}} = \frac{5.13 \text{ kg}}{5.13 \text{ kg} + 0.57 \text{ kg}} = 0.90$$

$$W_{\text{Mg}_2\text{Pb}} = 1.00 - 0.90 = 0.10$$

Now, if we apply the lever rule expression for  $W_\alpha$

$$W_\alpha = \frac{C_{\text{Mg}_2\text{Pb}} - C_o}{C_{\text{Mg}_2\text{Pb}} - C_\alpha}$$

Since the  $\text{Mg}_2\text{Pb}$  phase exists only at 81 wt% Pb, and  $C_o = 50$  wt% Pb

$$W_\alpha = 0.90 = \frac{81 - 50}{81 - C_\alpha}$$

Solving for  $C_\alpha$  from this expression yields  $C_\alpha = 46.6$  wt% Pb. From Figure 9.18, the maximum concentration of Pb in the  $\alpha$  phase in the  $\alpha + \text{Mg}_2\text{Pb}$  phase field is about 42 wt% Pb. Therefore, this alloy is not possible.

- 9.29 (a) From Figure 9.6, the maximum solubility of Cu in Ag at  $700^\circ\text{C}$  corresponds to the position of the  $\beta$ -( $\alpha + \beta$ ) phase boundary at this temperature, or to about 6 wt% Cu.  
(b) From this same figure, the maximum solubility of Ag in Cu corresponds to the position of the  $\alpha$ -( $\alpha + \beta$ ) phase boundary at this temperature, or about 5 wt% Ag.

- 9.30 We are asked to determine the approximate temperature from which a Pb-Mg alloy was quenched, given the mass fractions of  $\alpha$  and  $\text{Mg}_2\text{Pb}$  phases. We can write a lever-rule expression for the mass fraction of the  $\alpha$  phase as

$$W_{\alpha} = 0.65 = \frac{C_{\text{Mg}_2\text{Pb}} - C_0}{C_{\text{Mg}_2\text{Pb}} - C_{\alpha}}$$

The value of  $C_0$  is stated as 45 wt% Pb-55 wt% Mg, and  $C_{\text{Mg}_2\text{Pb}}$  is 81 wt% Pb-19 wt% Mg, which is independent of temperature (Figure 9.18); thus,

$$0.65 = \frac{81 - 45}{81 - C_{\alpha}}$$

which yields

$$C_{\alpha} = 25.6 \text{ wt\% Pb}$$

The temperature at which the  $\alpha$ -( $\alpha + \text{Mg}_2\text{Pb}$ ) phase boundary (Figure 9.18) has a value of 25.6 wt% Pb is about 360°C (680°F).

9.31 This problem asks if it is possible to have a Mg-Pb alloy for which the mass fractions of primary  $\alpha$  and total  $\alpha$  are 0.60 and 0.85, respectively, at 460°C. In order to make this determination we need to set up the appropriate lever rule expression for each of these quantities. From Figure 9.18 and at 460°C,  $C_{\alpha} = 41$  wt% Pb,  $C_{\text{Mg}_2\text{Pb}} = 81$  wt% Pb, and  $C_{\text{eutectic}} = 67$  wt% Pb.

For primary  $\alpha$

$$W_{\alpha'} = \frac{C_{\text{eutectic}} - C_0}{C_{\text{eutectic}} - C_{\alpha}} = \frac{67 - C_0}{67 - 41} = 0.60$$

Solving for  $C_0$  gives  $C_0 = 51.4$  wt% Pb.

Now the analogous expression for total  $\alpha$

$$W_{\alpha} = \frac{C_{\text{Mg}_2\text{Pb}} - C_0}{C_{\text{Mg}_2\text{Pb}} - C_{\alpha}} = \frac{81 - C_0}{81 - 41} = 0.85$$

And this value of  $C_0$  is 47 wt% Pb. Therefore, since these two  $C_0$  values are different, this alloy is **not** possible.

9.32 This problem asks if it is possible to have a Pb-Sn alloy for which the masses of primary  $\beta$  and total  $\beta$  are 2.21 and 2.53 kg, respectively in 2.8 kg total of the alloy at 180°C. In order to make this determination we first need to convert these masses to mass fractions. Thus,

$$W_{\beta'} = \frac{2.21 \text{ kg}}{2.8 \text{ kg}} = 0.789$$

$$W_{\beta} = \frac{2.53 \text{ kg}}{2.8 \text{ kg}} = 0.904$$

Next it is necessary to set up the appropriate lever rule expression for each of these quantities. From Figure 9.7 and at 180°C,  $C_{\alpha} = 18.3 \text{ wt\% Sn}$ ,  $C_{\beta} = 97.8 \text{ wt\% Sn}$ , and  $C_{\text{eutectic}} = 61.9 \text{ wt\% Sn}$ .

For primary  $\beta$

$$W_{\beta'} = \frac{C_o - C_{\text{eutectic}}}{C_{\beta} - C_{\text{eutectic}}} = \frac{C_o - 61.9}{97.8 - 61.9} = 0.789$$

Solving for  $C_o$  gives  $C_o = 90.2 \text{ wt\% Sn}$ .

Now the analogous expression for total  $\beta$

$$W_{\beta} = \frac{C_o - C_{\alpha}}{C_{\beta} - C_{\alpha}} = \frac{C_o - 18.3}{97.8 - 18.3} = 0.904$$

And this value of  $C_o$  is also 90.2 wt% Sn. Therefore, since these two  $C_o$  values are identical, this alloy is possible.

9.33 (a) This portion of the problem asks that we determine the mass fractions of  $\alpha$  and  $\beta$  phases for an 80 wt% Sn-20 wt% Pb alloy (at 180°C). In order to do this it is necessary to employ the lever rule using a tie line that extends entirely across the  $\alpha + \beta$  phase field (Figure 9.7), as follows:

$$W_{\alpha} = \frac{C_{\beta} - C_o}{C_{\beta} - C_{\alpha}} = \frac{97.8 - 80}{97.8 - 18.3} = 0.224$$

$$W_{\beta} = \frac{C_o - C_{\alpha}}{C_{\beta} - C_{\alpha}} = \frac{80 - 18.3}{97.8 - 18.3} = 0.776$$

(b) Now it is necessary to determine the mass fractions of primary  $\beta$  and eutectic microconstituents for this same alloy. This requires us to utilize the lever rule and a tie line that extends from the

maximum solubility of Pb in the  $\beta$  phase at 180°C (i.e., 97.8 wt% Sn) to the eutectic composition (61.9 wt% Sn). Thus

$$W_{\beta'} = \frac{C_o - C_{\text{eutectic}}}{C_{\beta} - C_{\text{eutectic}}} = \frac{80.0 - 61.9}{97.8 - 61.9} = 0.504$$

$$W_e = \frac{C_{\beta} - C_o}{C_{\beta} - C_{\text{eutectic}}} = \frac{97.8 - 80.0}{97.8 - 61.9} = 0.496$$

(c) And, finally, we are asked to compute the mass fraction of eutectic  $\beta$ ,  $W_{e\beta}$ . This quantity is simply the difference between the mass fractions of total  $\beta$  and primary  $\beta$  as

$$W_{e\beta} = W_{\beta} - W_{\beta'} = 0.776 - 0.504 = 0.272$$

9.34 This problem asks that we determine the composition of a Cu-Ag alloy at 775°C given that  $W_{\alpha'} = 0.73$  and  $W_{\text{eutectic}} = 0.27$ . Since there is a primary  $\alpha$  microconstituent present, we know that the alloy composition,  $C_o$  is between 8.0 and 71.9 wt% Ag (Figure 9.6). Furthermore, this figure also indicates that  $C_{\alpha} = 8.0$  wt% Ag and  $C_{\text{eutectic}} = 71.9$  wt% Ag. Applying the appropriate lever rule expression for  $W_{\alpha'}$ ,

$$W_{\alpha'} = \frac{C_{\text{eutectic}} - C_o}{C_{\text{eutectic}} - C_{\alpha}} = \frac{71.9 - C_o}{71.9 - 8.0} = 0.73$$

and solving for  $C_o$  yields  $C_o = 25.2$  wt% Ag.

9.35 We are given a hypothetical eutectic phase diagram for which  $C_{\text{eutectic}} = 64$  wt% B,  $C_{\alpha} = 12$  wt% B at the eutectic temperature, and also that  $W_{\beta'} = 0.367$  and  $W_{\beta} = 0.768$ ; from this we are asked to determine the composition of the alloy. Let us write lever rule expressions for  $W_{\beta'}$  and  $W_{\beta}$

$$W_{\beta} = \frac{C_o - C_{\alpha}}{C_{\beta} - C_{\alpha}} = \frac{C_o - 12}{C_{\beta} - 12} = 0.768$$

$$W_{\beta'} = \frac{C_o - C_{\text{eutectic}}}{C_{\beta} - C_{\text{eutectic}}} = \frac{C_o - 64}{C_{\beta} - 64} = 0.367$$

Thus, we have two simultaneous equations with  $C_o$  and  $C_\beta$  as unknowns. Solving them for  $C_o$  gives  $C_o = 75 \text{ wt\% B}$ .

9.36 Upon solidification, an alloy of eutectic composition forms a microstructure consisting of alternating layers of the two solid phases because during the solidification atomic diffusion must occur, and with this layered configuration the diffusion path length for the atoms is a minimum.

9.37 Schematic sketches of the microstructures that would be observed for an 64 wt% Zn-36 wt% Cu alloy at temperatures of 900°C, 820°C, 750°C, and 600°C are shown below. The phase compositions are also indicated.

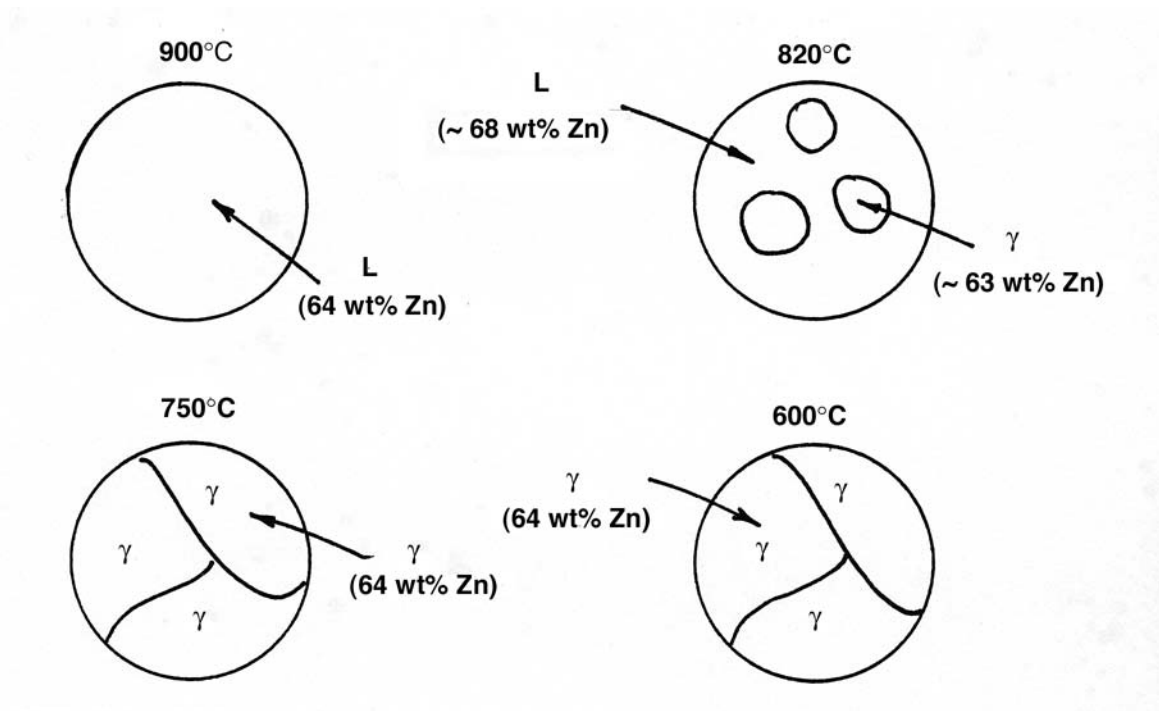

9.38 Schematic sketches of the microstructures that would be observed for a 76 wt% Pb-24 wt% Mg alloy at temperatures of 575°C, 500°C, 450°C, and 300°C are shown below. The phase compositions are also indicated.

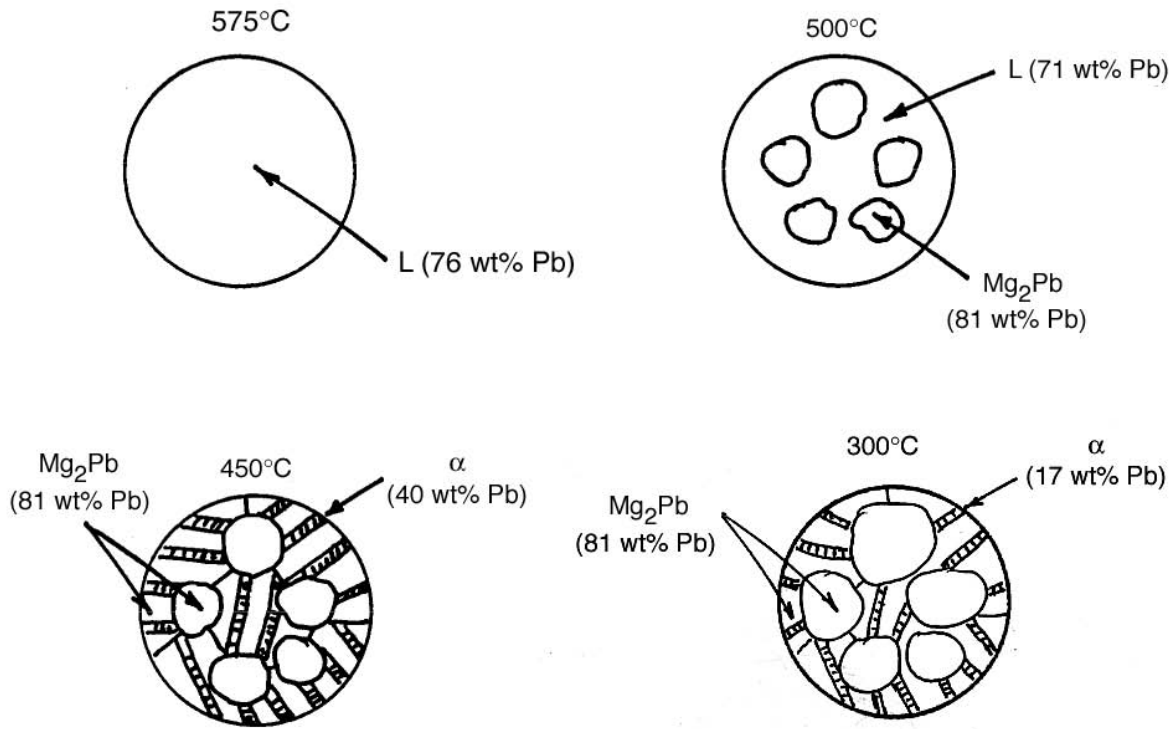

9.39 Schematic sketches of the microstructures that would be observed for a 52 wt% Zn-48 wt% Cu alloy at temperatures of 950°C, 860°C, 800°C, and 600°C are shown below. The phase compositions are also indicated.

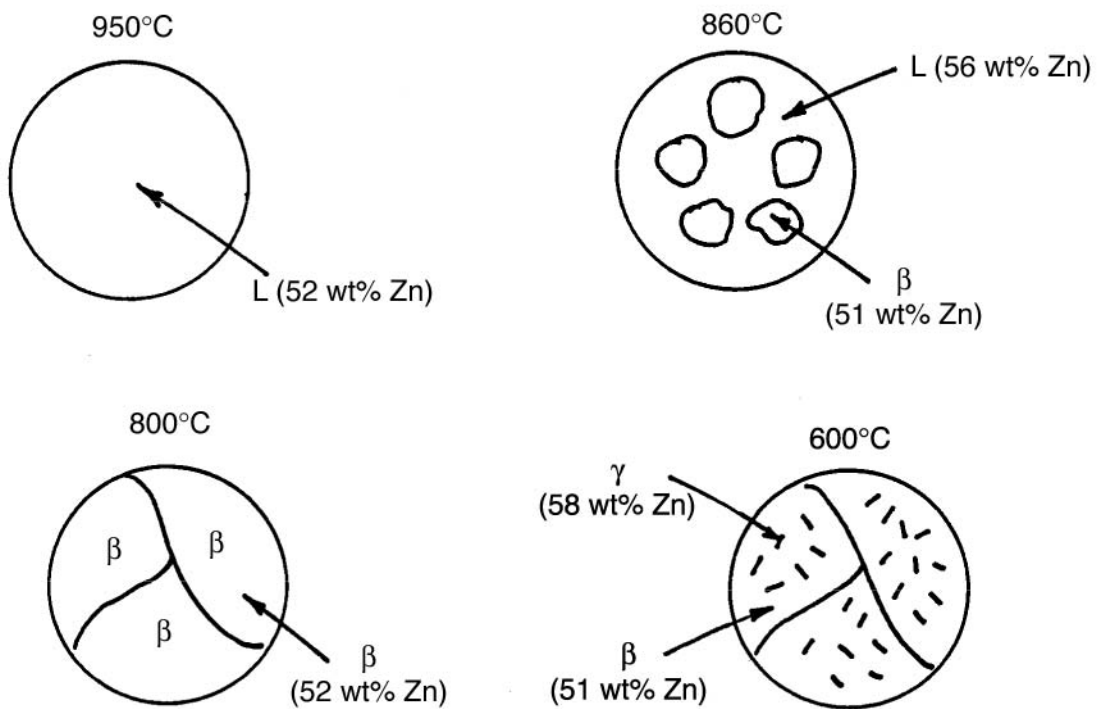

9.40 The principal difference between congruent and incongruent phase transformations is that for congruent no compositional changes occur with any of the phases that are involved in the transformation. For incongruent there will be compositional alterations of the phases.

9.41 In this problem we are asked to specify temperature-composition points for all eutectics, eutectoids, peritectics, and congruent phase transformations for the tin-gold system.

There are two eutectics on this phase diagram. One exists at 10 wt% Au-90 wt% Sn and 217°C. The reaction upon cooling is

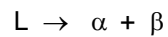

The other eutectic exists at 80 wt% Au-20 wt% Sn and 280°C. This reaction upon cooling is

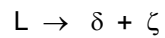

There are three peritectics. One exists at 30 wt% Au-70 wt% Sn and 252°C. Its reaction upon cooling is as follows:

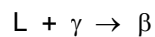

The second peritectic exists at 45 wt% Au-55 wt% Sn and 309°C. This reaction upon cooling is

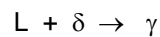

The third peritectic exists at 92 wt% Au-8 wt% Sn and 490°C. This reaction upon cooling is

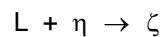

There is one congruent melting point at 62.5 wt% Au-37.5 wt% Sn and 418°C. Its reaction upon cooling is

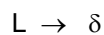

No eutectoids are present.

9.42 In this problem we are asked to specify temperature-composition points for all eutectics, eutectoids, peritectics, and congruent phase transformations for a portion of the aluminum-copper phase diagram.

There is one eutectic on this phase diagram, which exists at 8.3 wt% Al-91.7 wt% Cu and 1036°C. Its reaction upon cooling is

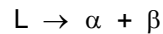

There are four eutectoids for this system. One exists at 11.8 wt% Al-88.2 wt% Cu and 565°C. This reaction upon cooling is

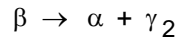

Another eutectoid exists at 15.4 wt% Al-84.6 wt% Cu and 964°C. For cooling the reaction is

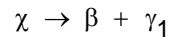

A third eutectoid exists at 15.5 wt% Al-84.5 wt% Cu and 786°C. For cooling the reaction is

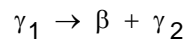

The other eutectoid exists at 23.5 wt% Al-76.5 wt% Cu and 560°C. For cooling the reaction is

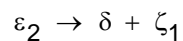

There are four peritectics on this phase diagram. One exists at 15.3 wt% Al-84.7 wt% Cu and 1037°C. The reaction upon cooling is



Another peritectic exists at 17 wt% Al-83 wt% Cu and 1021°C. Its cooling reaction is

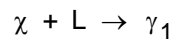

Another peritectic exists at 20.5 wt% Al-79.5 wt% Cu and 961°C. The reaction upon cooling is





Another peritectic exists at 28.4 wt% Al-71.6 wt% Cu and 626°C. The reaction upon cooling is



There is a single congruent melting point that exists at 12.5 wt% Al-87.5 wt% Cu and 1049°C. The reaction upon cooling is

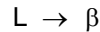

9.43W This problem asks for us to compute the maximum number of phases that may be present for a ternary system assuming that pressure is held constant. For a ternary system ( $C = 3$ ) at constant pressure ( $N = 1$ ), Gibbs phase rule, Equation (9.1W), becomes

$$P + F = C + N = 3 + 1 = 4$$

Or,

$$P = 4 - F$$

Thus, when  $F = 0$ ,  $P$  will have its maximum value of 4, which means that the maximum number of phases present for this situation is 4.

9.44W We are asked to specify the value of  $F$  for Gibbs phase rule at points A, B, and C on the pressure-temperature diagram for  $H_2O$ . Gibbs phase rule in general form is

$$P + F = C + N$$

For this system, the number of components,  $C$ , is 1, whereas  $N$ , the number of noncompositional variables, is 2--viz. temperature and pressure. Thus, the phase rule now becomes

$$P + F = 1 + 2 = 3$$

Or

$$F = 3 - P$$

where  $P$  is the number of phases present at equilibrium.

At point A, only a single (liquid) phase is present (i.e.,  $P = 1$ ), or

$$F = 3 - P = 3 - 1 = 2$$

which means that both temperature and pressure are necessary to define the system.

At point B which is on the phase boundary between liquid and vapor phases, two phases are in equilibrium ( $P = 2$ ); hence

$$F = 3 - P = 3 - 2 = 1$$

Or that we need to specify the value of either temperature or pressure, which determines the value of the other (pressure or temperature).

And, finally, at point C, three phases are present—viz. ice I, vapor, and liquid—and the number of degrees of freedom is zero since

$$F = 3 - P = 3 - 3 = 0$$

Thus, point C is an invariant point (in this case a triple point), and we have no choice in the selection of externally controllable variables in order to define the system.

9.45 Below is shown the phase diagram for these two A and B metals.

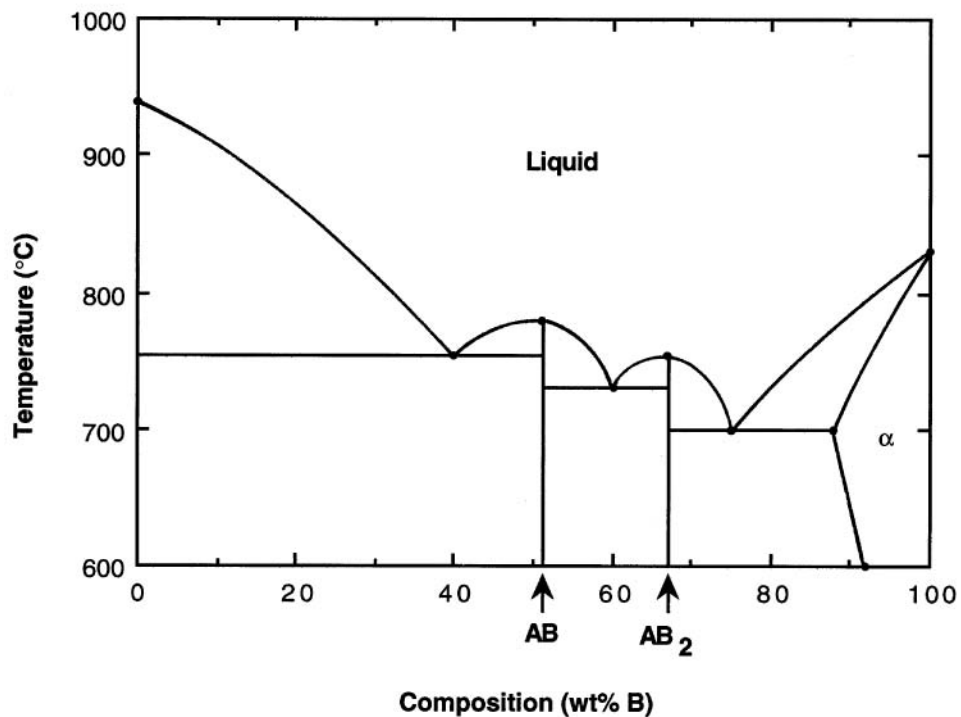

9.46 This problem gives us the compositions in weight percent for the two intermetallic compounds AB and AB<sub>2</sub>, and then asks us to identify element B if element A is potassium. Probably the easiest way to solve this problem is to first compute the ratio of the atomic weights of these two elements using Equation (4.6a); then, since we know the atomic weight of potassium (39.10 g/mol), it is possible to determine the atomic weight of element B, from which an identification may be made.

First of all, consider the AB intermetallic compound; inasmuch as it contains the same numbers of A and B atoms, its composition in atomic percent is 50 at% A-50 at% B. Equation (4.6a) may be written in the form:

$$C'_B = \frac{C_B A_A}{C_A A_B + C_B A_A} \times 100$$

where  $A_A$  and  $A_B$  are the atomic weights for elements A and B, and  $C_A$  and  $C_B$  are their compositions in weight percent. For this AB compound, and making the appropriate substitutions into the above equation leads to

$$50 \text{ at\% B} = \frac{(65.7 \text{ wt\% B})(A_A)}{(34.3 \text{ wt\% A})(A_B) + (65.7 \text{ wt\% B})(A_A)} \times 100$$

Now, solving this expression yields,

$$A_B = 1.916 A_A$$

Since potassium is element A and it has an atomic weight of 39.10 g/mol, the atomic weight of element B is just

$$A_B = (1.916)(39.10 \text{ g/mol}) = 74.92 \text{ g/mol}$$

Upon consultation of the period table of the elements (Figure 2.6) we note that arsenic has an atomic weight of 74.92 g/mol; therefore, element B is arsenic.

9.47 This problem asks that we compute the mass fractions of ferrite and cementite in pearlite. The lever-rule expression for ferrite is

$$W_\alpha = \frac{C_{\text{Fe}_3\text{C}} - C_o}{C_{\text{Fe}_3\text{C}} - C_\alpha}$$

and, since  $C_{\text{Fe}_3\text{C}} = 6.70$  wt% C,  $C_o = 0.76$  wt% C, and  $C_\alpha = 0.022$  wt% C

$$W_\alpha = \frac{6.70 - 0.76}{6.70 - 0.022} = 0.89$$

Similarly, for cementite

$$W_{\text{Fe}_3\text{C}} = \frac{C_o - C_\alpha}{C_{\text{Fe}_3\text{C}} - C_\alpha} = \frac{0.76 - 0.022}{6.70 - 0.022} = 0.11$$

9.48 A **phase** is a homogeneous portion of the system having uniform physical and chemical characteristics, whereas a **microconstituent** is an identifiable element of the microstructure (that may consist of more than one phase).

9.49 (a) A **hypoeutectoid** steel has a carbon concentration less than the eutectoid; on the other hand, a **hypereutectoid** steel has a carbon content greater than the eutectoid.

(b) For a hypoeutectoid steel, the proeutectoid ferrite is a microconstituent that formed above the eutectoid temperature. The eutectoid ferrite is one of the constituents of pearlite that formed at a temperature below the eutectoid. The carbon concentration for both ferrites is 0.022 wt% C.

9.50 A proeutectoid phase normally forms along austenite grain boundaries because there is an interfacial energy associated with these boundaries. When a proeutectoid phase forms within austenite, an interfacial energy also exists at the interface between the two phases. A lower net interfacial energy increase results when the proeutectoid phase forms along the existing austenite grain boundaries than when the proeutectoid phase forms within the interior of the grains.

9.51 This problem asks that we compute the carbon concentration of an iron-carbon alloy for which the fraction of total ferrite is 0.94. Application of the lever rule [of the form of Equation (9.12)] yields

$$W_\alpha = 0.94 = \frac{C_{\text{Fe}_3\text{C}} - C'_o}{C_{\text{Fe}_3\text{C}} - C_\alpha} = \frac{6.70 - C'_o}{6.70 - 0.022}$$

and solving for  $C'_o$

$$C'_o = 0.42 \text{ wt\% C}$$

9.52 In this problem we are given values of  $W_\alpha$  and  $W_{\text{Fe}_3\text{C}}$  (0.86 and 0.14, respectively) for an iron-carbon alloy and then are asked to specify the proeutectoid phase. Employment of the lever rule for total  $\alpha$  leads to

$$W_\alpha = 0.86 = \frac{C_{\text{Fe}_3\text{C}} - C_o}{C_{\text{Fe}_3\text{C}} - C_\alpha} = \frac{6.70 - C_o}{6.70 - 0.022}$$

Now, solving for  $C_o$ , the alloy composition, leads to  $C_o = 0.96 \text{ wt\% C}$ . Therefore, the proeutectoid phase is  $\text{Fe}_3\text{C}$  since  $C_o$  is greater than  $0.76 \text{ wt\% C}$ .

9.53 This problem asks us to consider various aspects of 1.0 kg of austenite containing 1.15 wt% C that is cooled to below the eutectoid.

(a) The proeutectoid phase will be  $\text{Fe}_3\text{C}$  since 1.15 wt% C is greater than the eutectoid (0.76 wt% C).

(b) For this portion of the problem, we are asked to determine how much total ferrite and cementite form. Application of the appropriate lever rule expression yields

$$W_\alpha = \frac{C_{\text{Fe}_3\text{C}} - C_o}{C_{\text{Fe}_3\text{C}} - C_\alpha} = \frac{6.70 - 1.15}{6.70 - 0.022} = 0.83$$

which, when multiplied by the total mass of the alloy (1.0 kg), gives 0.83 kg of total ferrite.

Similarly, for total cementite,

$$W_{\text{Fe}_3\text{C}} = \frac{C_o - C_\alpha}{C_{\text{Fe}_3\text{C}} - C_\alpha} = \frac{1.15 - 0.022}{6.70 - 0.022} = 0.17$$

And the mass of total cementite that forms is  $(0.17)(1.0 \text{ kg}) = 0.17 \text{ kg}$ .

(c) Now we are asked to calculate how much pearlite and the proeutectoid phase (cementite) form. Applying Equation (9.20), in which  $C'_1 = 1.15 \text{ wt\% C}$

$$W_p = \frac{6.70 - C'_1}{6.70 - 0.76} = \frac{6.70 - 1.15}{6.70 - 0.76} = 0.93$$

which corresponds to a mass of 0.93 kg. Likewise, from Equation (9.21)

$$W_{\text{Fe}_3\text{C}'} = \frac{C_1' - 0.76}{5.94} = \frac{1.15 - 0.76}{5.94} = 0.07$$

which is equivalent to 0.07 kg of the total 1 kg mass.

(d) Schematically, the microstructure would appear as:

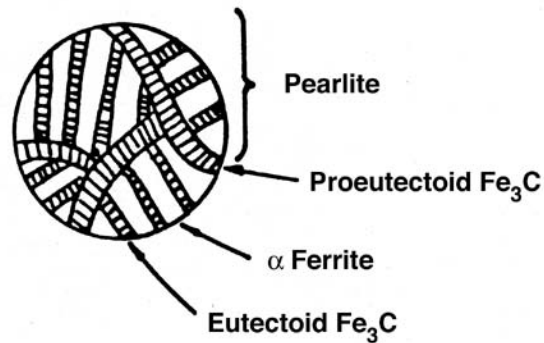

9.54 We are called upon to consider various aspects of 2.5 kg of austenite containing 0.65 wt% C, that is cooled to below the eutectoid.

(a) Ferrite is the proeutectoid phase since 0.65 wt% C is less than 0.76 wt% C.

(b) For this portion of the problem, we are asked to determine how much total ferrite and cementite form. Application of the appropriate lever rule expression yields

$$W_{\alpha} = \frac{C_{\text{Fe}_3\text{C}} - C_o}{C_{\text{Fe}_3\text{C}} - C_{\alpha}} = \frac{6.70 - 0.65}{6.70 - 0.022} = 0.91$$

which corresponds to  $(0.91)(2.5 \text{ kg}) = 2.26 \text{ kg}$  of total ferrite.

Similarly, for total cementite,

$$W_{\text{Fe}_3\text{C}} = \frac{C_o - C_{\alpha}}{C_{\text{Fe}_3\text{C}} - C_{\alpha}} = \frac{0.65 - 0.022}{6.70 - 0.022} = 0.09$$

Or  $(0.09)(2.5 \text{ kg}) = 0.24 \text{ kg}$  of total cementite form.

(c) Now consider the amounts of pearlite and proeutectoid ferrite. Using Equation (9.18)

$$W_p = \frac{C_o' - 0.022}{0.74} = \frac{0.65 - 0.022}{0.74} = 0.85$$

This corresponds to  $(0.85)(2.5 \text{ kg}) = 2.12 \text{ kg}$  of pearlite.

Also, from Equation (9.19),

$$W_{\alpha'} = \frac{0.76 - 0.65}{0.74} = 0.15$$

Or, there are  $(0.15)(2.5 \text{ kg}) = 0.38 \text{ kg}$  of proeutectoid ferrite.

(d) Schematically, the microstructure would appear as:

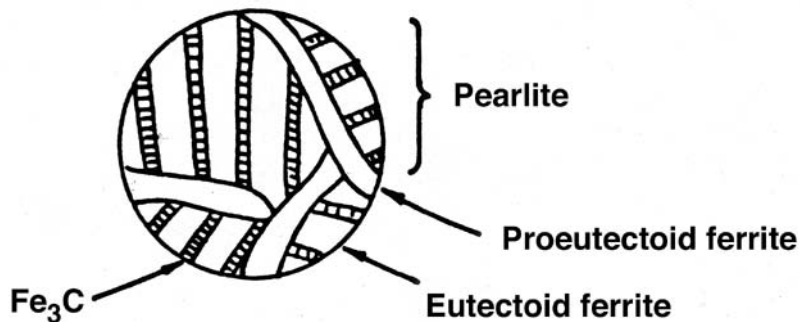

9.55 The mass fractions of proeutectoid ferrite and pearlite that form in a 0.25 wt% C iron-carbon alloy are considered in this problem. From Equation (9.18)

$$W_p = \frac{C'_o - 0.022}{0.74} = \frac{0.25 - 0.022}{0.74} = 0.31$$

And, from Equation (9.19)

$$W_{\alpha'} = \frac{0.76 - C'_o}{0.74} = \frac{0.76 - 0.25}{0.74} = 0.69$$

9.56 This problem asks that we determine the carbon concentration in an iron-carbon alloy, given the mass fractions of proeutectoid ferrite and pearlite (0.286 and 0.714, respectively). From Equation (9.18)

$$W_p = 0.714 = \frac{C'_o - 0.022}{0.74}$$

which yields  $C'_o = 0.55$  wt% C.

9.57 In this problem we are given values of  $W_\alpha$  and  $W_{Fe_3C}$  for an iron-carbon alloy (0.91 and 0.09, respectively), and then are asked to specify whether the alloy is hypoeutectoid or hypereutectoid. Employment of the lever rule for total  $\alpha$  leads to

$$W_\alpha = 0.91 = \frac{C_{Fe_3C} - C_o}{C_{Fe_3C} - C_\alpha} = \frac{6.70 - C_o}{6.70 - 0.022}$$

Now, solving for  $C_o$ , the alloy composition, leads to  $C_o = 0.62$  wt% C. Therefore, the alloy is hypoeutectoid since  $C_o$  is less than 0.76 wt% C.

9.58 We are asked in this problem to determine the concentration of carbon in an alloy for which  $W_{Fe_3C} = 0.11$  and  $W_p = 0.89$ . If we let  $C_o$  equal the carbon concentration in the alloy, employment of the appropriate lever rule expression, Equation (9.20), leads to

$$W_p = \frac{6.7 - C_o}{6.7 - 0.76} = 0.89$$

Solving for  $C_o$  yields  $C_o = 1.41$  wt% C.

9.59 In this problem we are asked to consider 2.0 kg of a 99.6 wt% Fe-0.4 wt% C alloy that is cooled to a temperature below the eutectoid.

(a) Equation (9.19) must be used in computing the amount of proeutectoid ferrite that forms. Thus,

$$W_{\alpha'} = \frac{0.76 - C'_o}{0.74} = \frac{0.76 - 0.40}{0.74} = 0.49$$

Or,  $(0.49)(2.0 \text{ kg}) = 0.99$  kg of proeutectoid ferrite forms.

(b) In order to determine the amount of eutectoid ferrite, it first becomes necessary to compute the amount of total ferrite using the lever rule applied entirely across the  $\alpha + Fe_3C$  phase field, as

$$W_\alpha = \frac{C_{Fe_3C} - C'_o}{C_{Fe_3C} - C_\alpha} = \frac{6.70 - 0.40}{6.70 - 0.022} = 0.94$$



which corresponds to  $(0.94)(2.0 \text{ kg}) = 1.89 \text{ kg}$ . Now, the amount of eutectoid ferrite is just the difference between total and proeutectoid ferrites, or

$$1.89 \text{ kg} - 0.99 \text{ kg} = 0.90 \text{ kg}$$

(c) With regard to the amount of cementite that forms, again application of the lever rule across the entirety of the  $\alpha + \text{Fe}_3\text{C}$  phase field, leads to

$$W_{\text{Fe}_3\text{C}} = \frac{C'_0 - C_\alpha}{C_{\text{Fe}_3\text{C}} - C_\alpha} = \frac{0.40 - 0.022}{6.70 - 0.022} = 0.06$$

which amounts to  $(0.06)(2 \text{ kg}) = 0.11 \text{ kg}$  cementite in the alloy.

9.60 This problem asks that we compute the maximum mass fraction of proeutectoid cementite possible for a hypereutectoid iron-carbon alloy. This requires that we utilize Equation (9.21) with  $C'_1 = 2.14$  wt% C, the maximum solubility of carbon in austenite. Thus,

$$W_{\text{Fe}_3\text{C}'} = \frac{C'_1 - 0.76}{5.94} = \frac{2.14 - 0.76}{5.94} = 0.232$$

9.61 This problem asks if it is possible to have an iron-carbon alloy for which  $W_{\text{Fe}_3\text{C}} = 0.057$  and  $W_{\alpha'} = 0.36$ . In order to make this determination, it is necessary to set up lever rule expressions for these two mass fractions in terms of the alloy composition, then to solve for the alloy composition of each; if both alloy composition values are equal, then such an alloy is possible. The expression for the mass fraction of total cementite is

$$W_{\text{Fe}_3\text{C}} = \frac{C_0 - C_\alpha}{C_{\text{Fe}_3\text{C}} - C_\alpha} = \frac{C_0 - 0.022}{6.70 - 0.022} = 0.057$$

Solving for this  $C_0$  yields  $C_0 = 0.40$  wt% C. Now for  $W_{\alpha'}$ , we utilize Equation (9.19) as

$$W_{\alpha'} = \frac{0.76 - C'_0}{0.74} = 0.36$$

This expression leads to  $C'_O = 0.49$  wt% C. And, since  $C_O$  and  $C'_O$  are different this alloy is **not** possible.

9.62 This problem asks if it is possible to have an iron-carbon alloy for which  $W_\alpha = 0.860$  and  $W_p = 0.969$ . In order to make this determination, it is necessary to set up lever rule expressions for these two mass fractions in terms of the alloy composition, then to solve for the alloy composition of each; if both alloy composition values are equal, then such an alloy is possible. The expression for the mass fraction of total ferrite is

$$W_\alpha = \frac{C_{Fe_3C} - C_O}{C_{Fe_3C} - C_\alpha} = \frac{6.70 - C_O}{6.70 - 0.022} = 0.860$$

Solving for this  $C_O$  yields  $C_O = 0.95$  wt% C. Now for  $W_p$  we utilize Equation (9.20) as

$$W_p = \frac{6.70 - C'_1}{5.94} = 0.969$$

This expression leads to  $C'_1 = 0.95$  wt% C. Since  $C_O = C'_1$ , this alloy is possible.

9.63 This problem asks that we compute the mass fraction of eutectoid cementite in an iron-carbon alloy that contains 1.00 wt% C. In order to solve this problem it is necessary to compute mass fractions of total and proeutectoid cementites, and then to subtract the latter from the former. To calculate the mass fraction of total cementite, it is necessary to use the lever rule and a tie line that extends across the entire  $\alpha + Fe_3C$  phase field as

$$W_{Fe_3C} = \frac{C_O - C_\alpha}{C_{Fe_3C} - C_\alpha} = \frac{1.00 - 0.022}{6.70 - 0.022} = 0.146$$

Now, for the mass fraction of proeutectoid cementite we use Equation (9.21)

$$W_{Fe_3C'} = \frac{C'_1 - 0.76}{5.94} = \frac{1.00 - 0.76}{5.94} = 0.040$$

And, finally, the mass fraction of eutectoid cementite  $W_{Fe_3C''}$  is just

$$W_{\text{Fe}_3\text{C}''} = W_{\text{Fe}_3\text{C}} - W_{\text{Fe}_3\text{C}'} = 0.146 - 0.040 = 0.106$$

9.64 This problem asks whether or not it is possible to determine the composition of an iron-carbon alloy for which the mass fraction of eutectoid cementite is 0.109; and if so, to calculate the composition. Yes, it is possible to determine the alloy composition; and, in fact, there are two possible answers. For the first, the eutectoid cementite exists in addition to proeutectoid cementite. For this case the mass fraction of eutectoid cementite ( $W_{\text{Fe}_3\text{C}''}$ ) is just the difference between total cementite and proeutectoid cementite mass fractions; that is

$$W_{\text{Fe}_3\text{C}''} = W_{\text{Fe}_3\text{C}} - W_{\text{Fe}_3\text{C}'}$$

Now, it is possible to write expressions for  $W_{\text{Fe}_3\text{C}}$  and  $W_{\text{Fe}_3\text{C}'}$  in terms of  $C_0$ , the alloy composition.

Thus,

$$\begin{aligned} W_{\text{Fe}_3\text{C}''} &= \frac{C_0 - C_\alpha}{C_{\text{Fe}_3\text{C}} - C_\alpha} - \frac{C_0 - 0.76}{5.94} \\ &= \frac{C_0 - 0.022}{6.70 - 0.022} - \frac{C_0 - 0.76}{5.94} = 0.109 \end{aligned}$$

And, solving for  $C_0$  yields  $C_0 = 0.84$  wt% C.

For the second possibility, we have a hypoeutectoid alloy wherein all of the cementite is eutectoid cementite. Thus, it is necessary to set up a lever rule expression wherein the mass fraction of total cementite is 0.109. Therefore,

$$W_{\text{Fe}_3\text{C}} = \frac{C_0 - C_\alpha}{C_{\text{Fe}_3\text{C}} - C_\alpha} = \frac{C_0 - 0.022}{6.70 - 0.022} = 0.109$$

And, solving for  $C_0$  yields  $C_0 = 0.75$  wt% C.

9.65 This problem asks whether or not it is possible to determine the composition of an iron-carbon alloy for which the mass fraction of eutectoid ferrite is 0.71; and if so, to calculate the composition. Yes, it is possible to determine the alloy composition; and, in fact, there are two possible answers. For the first, the eutectoid ferrite exists in addition to proeutectoid ferrite. For this case the mass fraction of eutectoid ferrite ( $W_{\alpha''}$ ) is just the difference between total ferrite and proeutectoid ferrite mass fractions; that is

$$W_{\alpha''} = W_\alpha - W_{\alpha'}$$

Now, it is possible to write expressions for  $W_{\alpha'}$  and  $W_{\alpha''}$  in terms of  $C_o$ , the alloy composition. Thus,

$$W_{\alpha''} = \frac{C_{Fe_3C} - C_o}{C_{Fe_3C} - C_{\alpha}} = \frac{0.76 - C_o}{0.74}$$

$$= \frac{6.70 - C_o}{6.70 - 0.022} = \frac{0.76 - C_o}{0.74} = 0.71$$

And, solving for  $C_o$  yields  $C_o = 0.61$  wt% C.

For the second possibility, we have a hypereutectoid alloy wherein all of the ferrite is eutectoid ferrite. Thus, it is necessary to set up a lever rule expression wherein the mass fraction of total ferrite is 0.71. Therefore,

$$W_{\alpha} = \frac{C_{Fe_3C} - C_o}{C_{Fe_3C} - C_{\alpha}} = \frac{6.70 - C_o}{6.70 - 0.022} = 0.71$$

And, solving for  $C_o$  yields  $C_o = 1.96$  wt% C.

9.66 Schematic microstructures for the iron-carbon alloy of composition 3 wt% C-97 wt% Fe and at temperatures of 1250°C, 1145°C, and 700°C are shown below; approximate phase compositions are also indicated.

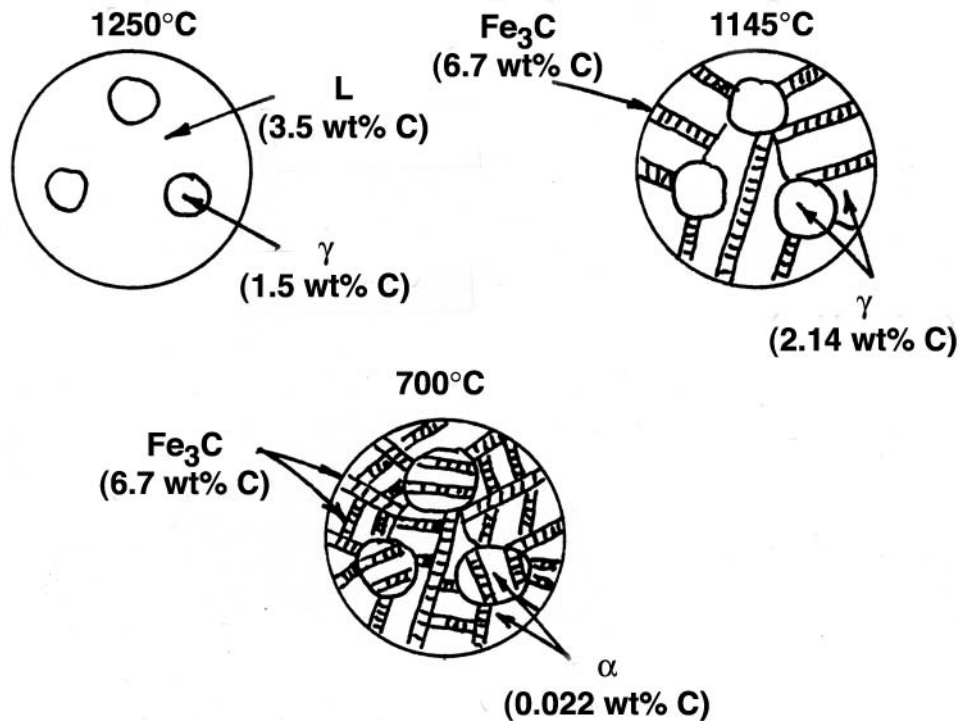

9.67 This problem asks that we determine the approximate Brinell hardness of a 99.8 wt% Fe-0.2 wt% C alloy. First, we compute the mass fractions of pearlite and proeutectoid ferrite using Equations (9.18) and (9.19), as

$$W_p = \frac{C'_0 - 0.022}{0.74} = \frac{0.20 - 0.022}{0.74} = 0.24$$

$$W_{\alpha'} = \frac{0.76 - C'_0}{0.74} = \frac{0.76 - 0.20}{0.74} = 0.76$$

Now, we compute the Brinell hardness of the alloy as

$$\begin{aligned} \text{HB}_{\text{alloy}} &= \text{HB}_{\alpha'} W_{\alpha'} + \text{HB}_p W_p \\ &= (80)(0.76) + (280)(0.24) = 128 \end{aligned}$$

9.68 We are asked in this problem to estimate the composition of the Pb-Sn alloy which microstructure is shown in Figure 9.15. Primary  $\alpha$  and eutectic microconstituents are present in the photomicrograph, and it is given that their densities are 11.2 and 8.7 g/cm<sup>3</sup>, respectively. Below is shown a square grid network onto which is superimposed outlines of the primary  $\alpha$  phase areas.

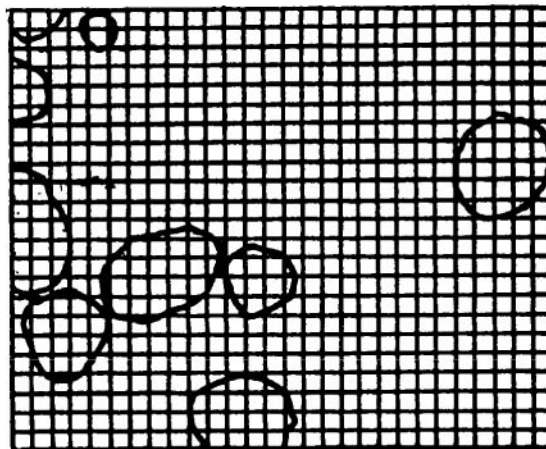

The area fraction of this primary  $\alpha$  phase may be determined by counting squares. There are a total of 644 squares, and of these, approximately 104 lie within the primary  $\alpha$  phase particles.

Thus, the area fraction of primary  $\alpha$  is  $104/644 = 0.16$ , which is also assumed to be the volume fraction.

We now want to convert the volume fractions into mass fractions in order to employ the lever rule to the Pb-Sn phase diagram. To do this, it is necessary to utilize Equations (9.7a) and (9.7b) as follows:

$$W_{\alpha'} = \frac{V_{\alpha'} \rho_{\alpha'}}{V_{\alpha'} \rho_{\alpha'} + V_{\text{eutectic}} \rho_{\text{eutectic}}}$$

$$= \frac{(0.16)(11.2 \text{ g/cm}^3)}{(0.16)(11.2 \text{ g/cm}^3) + (0.84)(8.7 \text{ g/cm}^3)} = 0.197$$

$$W_{\text{eutectic}} = \frac{V_{\text{eutectic}} \rho_{\text{eutectic}}}{V_{\alpha'} \rho_{\alpha'} + V_{\text{eutectic}} \rho_{\text{eutectic}}}$$

$$= \frac{(0.84)(8.7 \text{ g/cm}^3)}{(0.16)(11.2 \text{ g/cm}^3) + (0.84)(8.7 \text{ g/cm}^3)} = 0.803$$

From Figure 9.7, we want to use the lever rule and a tie-line that extends from the eutectic composition (61.9 wt% Sn) to the  $\alpha$ -( $\alpha + \beta$ ) phase boundary at 180°C (about 18.3 wt% Sn). Accordingly

$$W_{\alpha'} = 0.197 = \frac{61.9 - C_o}{61.9 - 18.3}$$

wherein  $C_o$  is the alloy composition (in wt% Sn). Solving for  $C_o$  yields  $C_o = 53.3$  wt% Sn. This  $C_o$  is close to the 50 wt% Sn value cited in the legend of Figure 9.15.

9.69 This problem asks us to consider an alloy of composition 97.5 wt% Fe, 2.0 wt% Mo, and 0.5 wt% C.

- From Figure 9.31, the eutectoid temperature for 2.0 wt% Mo is approximately 850°C.
- From Figure 9.32, the eutectoid composition is approximately 0.22 wt% C.
- Since the carbon concentration of the alloy (0.5 wt%) is greater than the eutectoid, cementite is the proeutectoid phase.

9.70 We are asked to consider a steel alloy of composition 93.8 wt% Fe, 6.0 wt% Ni, and 0.2 wt% C.

- From Figure 9.31, the eutectoid temperature for 6 wt% Ni is approximately 650°C (1200°F).

- (b) From Figure 9.32, the eutectoid composition is approximately 0.62 wt% C. Since the carbon concentration in the alloy (0.2 wt%) is less than the eutectoid, the proeutectoid phase is ferrite.
- (c) Assume that the  $\alpha$ -( $\alpha + \text{Fe}_3\text{C}$ ) phase boundary is at a negligible carbon concentration.

Modifying Equation (9.19) leads to

$$W_{\alpha'} = \frac{0.62 - C'_0}{0.62 - 0} = \frac{0.62 - 0.20}{0.62} = 0.68$$

Likewise, using a modified Equation (9.18)

$$W_p = \frac{C'_0 - 0}{0.62 - 0} = \frac{0.20}{0.62} = 0.32$$

## CHAPTER 10

### PHASE TRANSFORMATIONS IN METALS

#### PROBLEM SOLUTIONS

10.1 The two stages involved in the formation of particles of a new phase are **nucleation** and **growth**. The nucleation process involves the formation of normally very small particles of the new phase(s) which are stable and capable of continued growth. The growth stage is simply the increase in size of the new phase particles.

10.2 This problem calls for us to compute the length of time required for a reaction to go to 99% completion. It first becomes necessary to solve for the parameter **k** in Equation (10.1). Rearrangement of this equation leads to

$$k = -\frac{\ln(1-y)}{t^n} = -\frac{\ln(1-0.5)}{(100 \text{ s})^{1.7}} = 2.76 \times 10^{-4}$$

Now, solving for the time to go to 99% completion

$$t = \left[ -\frac{\ln(1-y)}{k} \right]^{1/n}$$
$$= \left[ -\frac{\ln(1-0.99)}{2.76 \times 10^{-4}} \right]^{1/1.7} = 305 \text{ s}$$

10.3 This problem asks that we compute the rate of some reaction given the values of **n** and **k** in Equation (10.1). Since the reaction rate is defined by Equation (10.2), it is first necessary to determine **t<sub>0.5</sub>**, or the time necessary for the reaction to reach **y = 0.5**. Solving for **t<sub>0.5</sub>** from Equation (10.1) leads to

$$t_{0.5} = \left[ -\frac{\ln(1-y)}{k} \right]^{1/n}$$



$$= \left[ -\frac{\ln(1 - 0.5)}{5 \times 10^{-4}} \right]^{1/2} = 37.23 \text{ s}$$

Now, the rate is just

$$\text{rate} = \frac{1}{t_{0.5}} = \frac{1}{37.23 \text{ s}} = 2.69 \times 10^{-2} \text{ (s)}^{-1}$$

10.4 This problem gives us the value of  $y$  (0.30) at some time  $t$  (100 min), and also the value of  $n$  (5.0) for the recrystallization of an alloy at some temperature, and then asks that we determine the rate of recrystallization at this same temperature. It is first necessary to calculate the value of  $k$  in Equation (10.1) as

$$k = -\frac{\ln(1 - y)}{t^n}$$

$$= -\frac{\ln(1 - 0.3)}{(100 \text{ min})^5} = 3.57 \times 10^{-11}$$

At this point we want to compute  $t_{0.5}$ , the value of  $t$  for  $y = 0.5$ , also using Equation (10.1). Thus

$$t_{0.5} = \left[ -\frac{\ln(1 - 0.5)}{k} \right]^{1/n}$$

$$= \left[ -\frac{\ln(1 - 0.5)}{3.57 \times 10^{-11}} \right]^{1/5} = 114.2 \text{ min}$$

And, therefore, from Equation (10.2), the rate is just

$$\text{rate} = \frac{1}{t_{0.5}} = \frac{1}{114.2 \text{ min}} = 8.76 \times 10^{-3} \text{ (min)}^{-1}$$

10.5 For this problem, we are given, for the austenite-to-pearlite transformation, two values of  $y$  and two values of the corresponding times, and are asked to determine the time required for 95% of the austenite to transform to pearlite.

The first thing necessary is to set up two expressions of the form of Equation (10.1), and then to solve simultaneously for the values of  $n$  and  $k$ . In order to expedite this process, we will

rearrange and do some algebraic manipulation of Equation (10.1). First of all, we rearrange as follows:

$$1 - y = \exp(-kt^n)$$

Now taking natural logarithms

$$\ln(1 - y) = -kt^n$$

Or

$$-\ln(1 - y) = kt^n$$

which may also be expressed as

$$\ln\left(\frac{1}{1 - y}\right) = kt^n$$

Now taking natural logarithms again, leads to

$$\ln\left[\ln\left(\frac{1}{1 - y}\right)\right] = \ln k + n \ln t$$

which is the form of the equation that we will now use. The two equations are thus

$$\ln\left\{\ln\left[\frac{1}{1 - 0.2}\right]\right\} = \ln k + n \ln(280 \text{ s})$$

$$\ln\left\{\ln\left[\frac{1}{1 - 0.6}\right]\right\} = \ln k + n \ln(425 \text{ s})$$

Solving these two expressions simultaneously for **n** and **k** yields **n** = 3.385 and **k** = 1.162 × 10<sup>-9</sup>.

Now it becomes necessary to solve for the value of **t** at which **y** = 0.95. Algebraic manipulation of Equation (10.1) leads to an expression in which **t** is the dependent parameter as

$$t = \left[ -\frac{\ln(1-y)}{k} \right]^{1/n}$$

$$= \left[ -\frac{\ln(1-0.95)}{1.162 \times 10^{-9}} \right]^{1/3.385} = 603 \text{ s}$$

10.6 For this problem, we are given, for the recrystallization of aluminum, two values of  $y$  and two values of the corresponding times, and are asked to determine the fraction recrystallized after a total time of 116.8 min.

The first thing necessary is to set up two expressions of the form of Equation (10.1), and then to solve simultaneously for the values of  $n$  and  $k$ . In order to expedite this process, we will rearrange and do some algebraic manipulation of Equation (10.1). First of all, we rearrange as follows:

$$1 - y = \exp(-kt^n)$$

Now taking natural logarithms

$$\ln(1-y) = -kt^n$$

Or

$$-\ln(1-y) = kt^n$$

which may also be expressed as

$$\ln\left(\frac{1}{1-y}\right) = kt^n$$

Now taking natural logarithms again, leads to

$$\ln\left[\ln\left(\frac{1}{1-y}\right)\right] = \ln k + n \ln t$$

which is the form of the equation that we will now use. The two equations are thus

$$\ln \left\{ \ln \left[ \frac{1}{1 - 0.30} \right] \right\} = \ln k + n \ln(95.2 \text{ min})$$

$$\ln \left\{ \ln \left[ \frac{1}{1 - 0.80} \right] \right\} = \ln k + n \ln(126.6 \text{ min})$$

Solving these two expressions simultaneously for **n** and **k** yields **n** = 5.286 and **k** = 1.239 x 10<sup>-11</sup>.

Now it becomes necessary to solve for **y** when **t** = 116.8 min. Application of Equation (10.1) leads to

$$y = 1 - \exp(-kt^n)$$

$$= 1 - \exp \left[ - \left( 1.239 \times 10^{-11} \right) (116.8 \text{ min})^{5.286} \right] = 0.65$$

10.7 This problem asks us to consider the percent recrystallized versus logarithm of time curves for copper shown in Figure 10.2.

(a) The rates at the different temperatures are determined using Equation (10.2), which rates are tabulated below:

Temperature (°C)	Rate (min) <sup>-1</sup>
135	0.105
119	4.4 x 10 <sup>-2</sup>
113	2.9 x 10 <sup>-2</sup>
102	1.25 x 10 <sup>-2</sup>
88	4.2 x 10 <sup>-3</sup>
43	3.8 x 10 <sup>-5</sup>

(b) These data are plotted below.

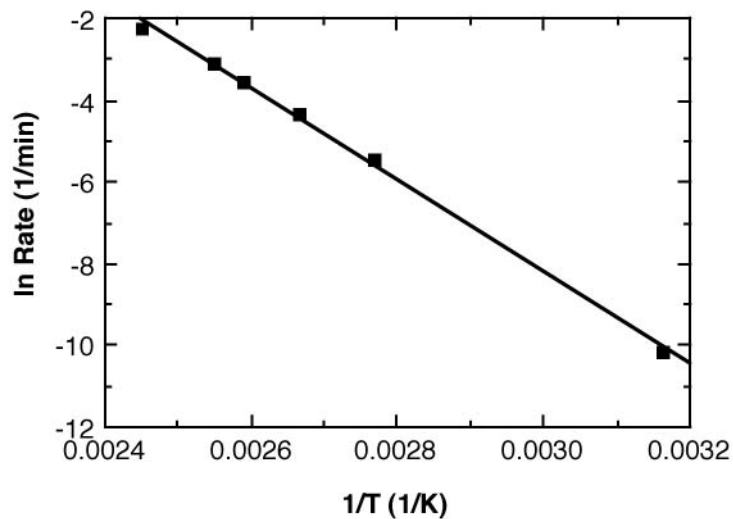

The activation energy,  $Q$ , is related to the slope of the line drawn through the data points as

$$Q = - \text{Slope} (R)$$

where  $R$  is the gas constant. The slope of this line is  $-1.126 \times 10^4 \text{ K}$ , and thus

$$\begin{aligned} Q &= - \left( -1.126 \times 10^4 \text{ K} \right) (8.31 \text{ J/mol} \cdot \text{K}) \\ &= 93,600 \text{ J/mol} \end{aligned}$$

(c) At room temperature ( $20^\circ\text{C}$ ),  $1/T = 3.41 \times 10^{-3} \text{ K}^{-1}$ . Extrapolation of the data in the plot to this  $1/T$  value gives

$$\ln(\text{rate}) \cong -12.8$$

which leads to

$$\text{rate} \cong \exp(-12.8) = 2.76 \times 10^{-6} (\text{min})^{-1}$$

But since

$$\text{rate} = \frac{1}{t_{0.5}}$$

then

$$t_{0.5} = \frac{1}{\text{rate}} = \frac{1}{2.76 \times 10^{-6} \text{ (min)}^{-1}}$$

$$= 3.62 \times 10^5 \text{ min} = 250 \text{ days}$$

10.8 In this problem we are asked to determine, from Figure 10.2, the values of the constants **n** and **k** [Equation (10.1)] for the recrystallization of copper at 119°C. One way to solve this problem is to take two values of percent recrystallization [which is just 100y, Equation (10.1)] and their corresponding time values, then set up two simultaneous equations, from which **n** and **k** may be determined. In order to expedite this process, we will rearrange and do some algebraic manipulation of Equation (10.1). First of all, we rearrange as follows:

$$1 - y = \exp(-kt^n)$$

Now taking natural logarithms

$$\ln(1 - y) = -kt^n$$

Or

$$-\ln(1 - y) = kt^n$$

which may also be expressed as

$$\ln\left(\frac{1}{1 - y}\right) = kt^n$$

Now taking natural logarithms again, leads to

$$\ln\left[\ln\left(\frac{1}{1 - y}\right)\right] = \ln k + n \ln t$$

which is the form of the equation that we will now use. From the 119°C curve of Figure 10.2, let us arbitrarily choose two percent recrystallized values, 20% and 80% (i.e., **y**<sub>1</sub> = 0.20 and **y**<sub>2</sub> = 0.80).

Their corresponding time values are  $t_1 = 16.1$  min and  $t_2 = 30.4$  min (realizing that the time axis is scaled logarithmically). Thus, our two simultaneous equations become

$$\ln \left[ \ln \left( \frac{1}{1 - 0.2} \right) \right] = \ln k + n \ln (16.1)$$

$$\ln \left[ \ln \left( \frac{1}{1 - 0.8} \right) \right] = \ln k + n \ln (30.4)$$

from which we obtain the values  $n = 3.11$  and  $k = 3.9 \times 10^{-5}$ .

10.9 Two limitations of the iron-iron carbide phase diagram are:

- 1) The nonequilibrium martensite phase does not appear on the diagram; and
- 2) The diagram provides no indication as to the time-temperature relationships for the formation of pearlite, bainite, and spheroidite, all of which are composed of the equilibrium ferrite and cementite phases.

10.10 (a) Superheating and supercooling correspond, respectively, to heating or cooling above or below a phase transition temperature without the occurrence of the transformation.

- (b) Superheating and supercooling occur because right at the phase transition temperature, the driving force is not sufficient to cause the transformation to occur. The driving force is enhanced during superheating or supercooling.

10.11 We are called upon to consider the isothermal transformation of an iron-carbon alloy of eutectoid composition.

- (a) From Figure 10.13, a horizontal line at  $550^\circ\text{C}$  intersects the 50% and reaction completion curves at about 2.5 and 6 seconds, respectively; these are the times asked for in the problem.
- (b) The pearlite formed will be fine pearlite. From Figure 10.21(a), the hardness of an alloy of composition 0.76 wt% C that consists of fine pearlite is about 265 HB (27 HRC).

10.12 The microstructures of pearlite, bainite, and spheroidite all consist of  $\alpha$ -ferrite and cementite phases. For pearlite, the two phases exist as layers that alternate with one another. Bainite consists of very fine and parallel needles of ferrite that are separated by elongated particles of cementite. For spheroidite, the matrix is ferrite, and the cementite phase is in the shape of spheroidal-shaped particles.

Bainite is harder and stronger than pearlite, which, in turn, is harder and stronger than spheroidite.

10.13 The driving force for the formation of spheroidite is the net reduction in ferrite-cementite phase boundary area.

10.14 This problem asks us to determine the nature of the final microstructure of an iron-carbon alloy of eutectoid composition, that has been subjected to various isothermal heat treatments. Figure 10.13 is used in these determinations.

- (a) 50% coarse pearlite and 50% martensite
- (b) 100% spheroidite
- (c) 50% fine pearlite, 25% bainite , and 25% martensite
- (d) 100% martensite
- (e) 40% bainite and 60% martensite
- (f) 100% bainite
- (g) 100% fine pearlite
- (h) 100% tempered martensite

10.15 Below is shown the isothermal transformation diagram for a eutectoid iron-carbon alloy, with time-temperature paths that will yield (a) 100% coarse pearlite; (b) 50% martensite and 50% austenite; and (c) 50% coarse pearlite, 25% bainite, and 25% martensite.



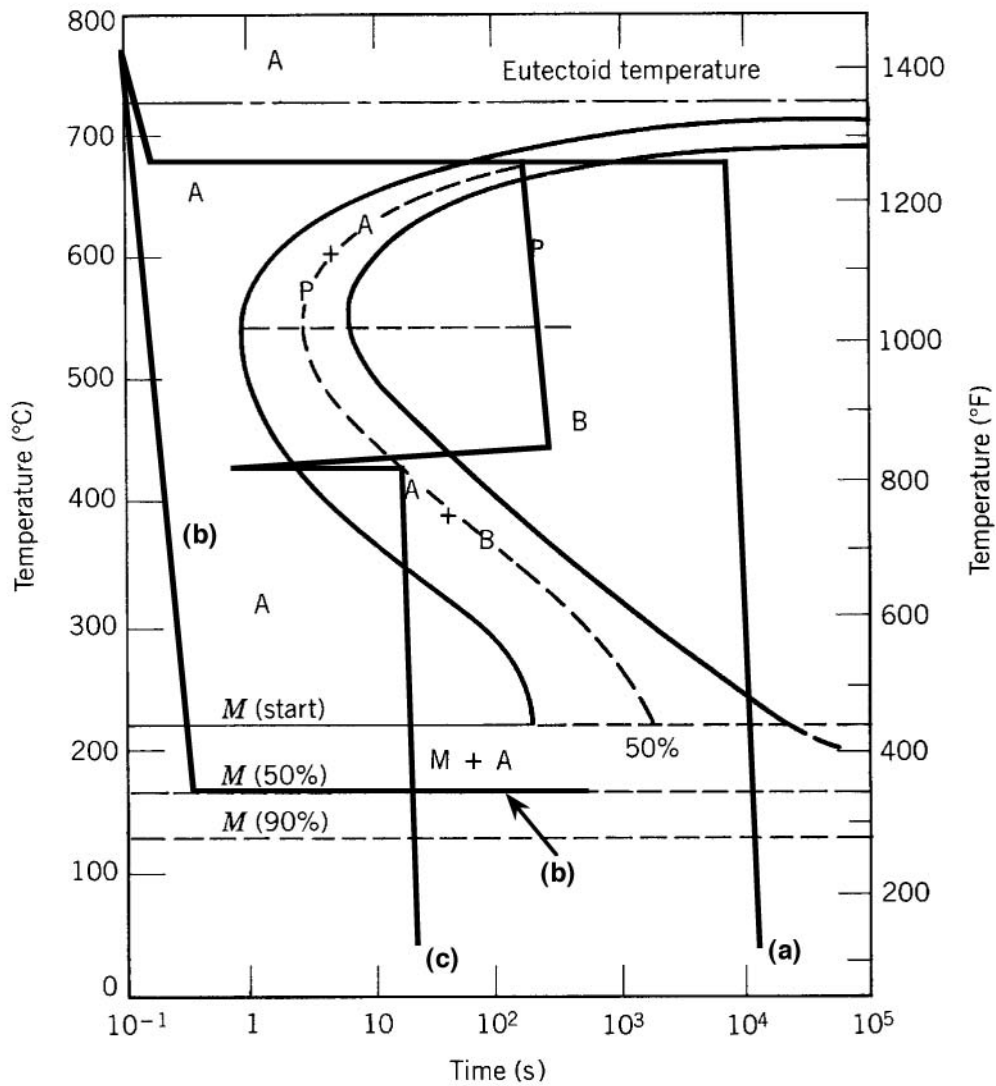

10.16 We are asked to determine which microconstituents are present in a 1.13 wt% C iron-carbon alloy that has been subjected to various isothermal heat treatments.

- (a) Martensite
- (b) Proeutectoid cementite and martensite
- (c) Bainite
- (d) Spheroidite
- (e) Cementite, medium pearlite, bainite, and martensite
- (f) Bainite and martensite
- (g) Proeutectoid cementite, pearlite, and martensite
- (h) Proeutectoid cementite and fine pearlite

10.17 This problem asks us to determine the approximate percentages of the microconstituents that form for five of the heat treatments described in Problem 10.16.

- (a) 100% martensite
- (c) 100% bainite
- (d) 100% spheroidite
- (f) 60% bainite and 40% martensite
- (h) After holding for 7 s at 600°C, the specimen has completely transformed to proeutectoid cementite and fine pearlite; no further reaction will occur at 450°C. Therefore, we can calculate the mass fractions using the appropriate lever rule expressions, Equations (9.20) and (9.21), as follows:

$$W_{\text{Fe}_3\text{C}'} = \frac{C_1' - 0.76}{5.94} = \frac{1.13 - 0.76}{5.94} = 0.062 \text{ or } 6.2\%$$

$$W_p = \frac{6.70 - C_1'}{5.94} = \frac{6.70 - 1.13}{5.94} = 0.938 \text{ or } 93.8\%$$

10.18 Below is shown an isothermal transformation diagram for a 1.13 wt% C iron-carbon alloy, with time-temperature paths that will produce (a) 6.2% proeutectoid cementite and 93.8% coarse pearlite; (b) 50% fine pearlite and 50% bainite; (c) 100% martensite; and (d) 100% tempered martensite.

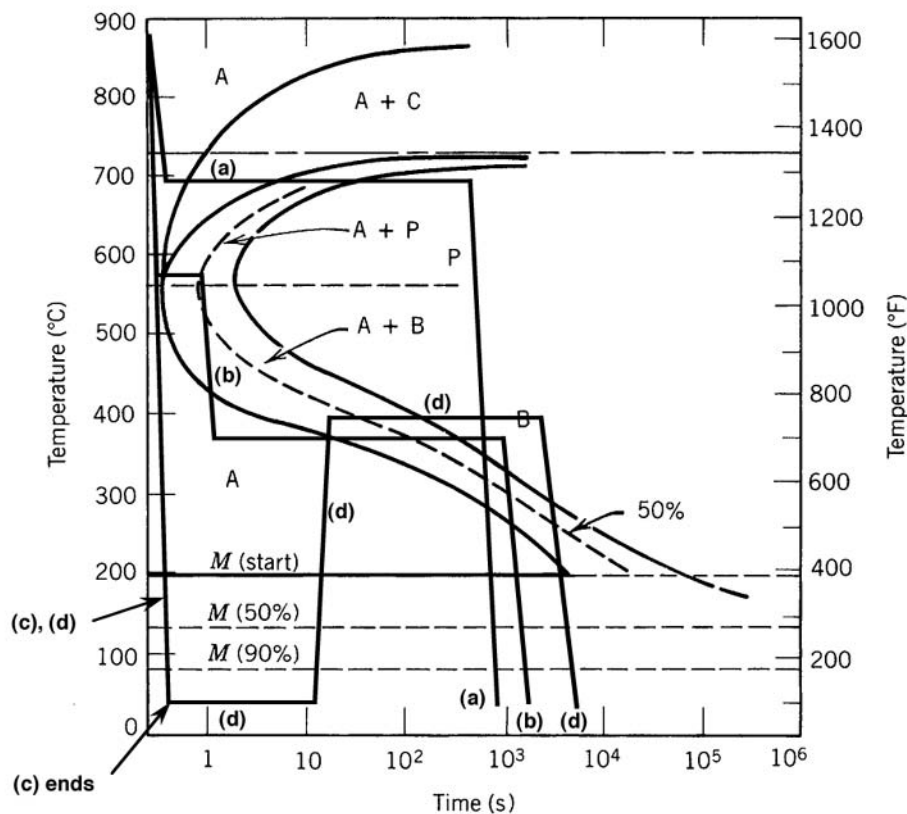

10.19 We are called upon to name the microstructural products that form for specimens of an iron-carbon alloy of eutectoid composition that are continuously cooled to room temperature at a variety of rates. Figure 10.18 is used in these determinations.

- (a) At a rate of 200°C/s, only martensite forms.
- (b) At a rate of 100°C/s, both martensite and pearlite form.
- (c) At a rate of 20°C/s, only fine pearlite forms.

10.20 Below is shown a continuous cooling transformation diagram for a 0.35 wt% C iron-carbon alloy, with continuous cooling paths that will produce (a) fine pearlite and proeutectoid ferrite; (b) martensite; (c) martensite and proeutectoid ferrite; (d) coarse pearlite and proeutectoid ferrite; and (e) martensite, fine pearlite, and proeutectoid ferrite.

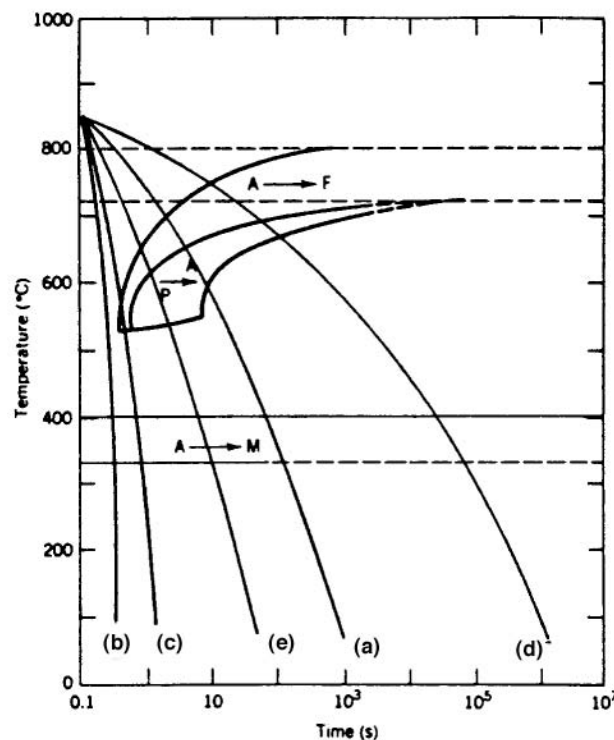

10.21 Two major differences between martensitic and pearlitic transformations are 1) atomic diffusion is necessary for the pearlitic transformation, whereas the martensitic transformation is diffusionless; and 2) relative to transformation rate, the martensitic transformation is virtually instantaneous, while the pearlitic transformation is time-dependent.

10.22 Two important differences between continuous cooling transformation diagrams for plain carbon and alloy steels are: 1) for an alloy steel, a bainite nose will be present, which nose will be absent for plain carbon alloys; and 2) the pearlite-proeutectoid noses for plain carbon steel alloys are positioned at shorter times than for the alloy steels.

10.23 There is no bainite transformation region on the continuous cooling transformation diagram for an iron-carbon alloy of eutectoid composition (Figure 10.16) because by the time a cooling curve has passed into the bainite region, the entirety of the alloy specimen will have transformed to pearlite.

10.24 This problem asks for the microstructural products that form when specimens of a 4340 steel are continuously cooled to room temperature at several rates. Figure 10.19 is used for these determinations.

- (a) At a cooling rate of  $10^{\circ}\text{C/s}$ , only martensite forms.
- (b) At a cooling rate of  $1^{\circ}\text{C/s}$ , both martensite and bainite form.
- (c) At a cooling rate of  $0.1^{\circ}\text{C/s}$ , martensite, proeutectoid ferrite, and bainite form.
- (d) At a cooling rate of  $0.01^{\circ}\text{C/s}$ , martensite, proeutectoid ferrite, pearlite, and bainite form.

10.25 This problem asks that we briefly describe the simplest continuous cooling heat treatment procedure that would be used in converting a 4340 steel from one microstructure to another. Solutions to this problem require the use of Figure 10.19.

- (a) In order to convert from (martensite + ferrite + bainite) to (martensite + ferrite + pearlite + bainite) it is necessary to heat above about  $720^{\circ}\text{C}$ , allow complete austenitization, then cool to room temperature at a rate between  $0.02$  and  $0.006^{\circ}\text{C/s}$ .
- (b) To convert from (martensite + ferrite + bainite) to spheroidite the alloy must be heated to about  $700^{\circ}\text{C}$  for several hours.
- (c) In order to convert from (martensite + bainite + ferrite) to tempered martensite it is necessary to heat to above about  $720^{\circ}\text{C}$ , allow complete austenitization, then cool to room temperature at a rate greater than  $8.3^{\circ}\text{C/s}$ , and finally isothermally heat treat the alloy at a temperature between about  $400$  and  $550^{\circ}\text{C}$  (Figure 10.25) for about one hour.

10.26 For moderately rapid cooling, the time allowed for carbon diffusion is not as great as for slower cooling rates. Therefore, the diffusion distance is shorter, and thinner layers of ferrite and cementite form (i.e., fine pearlite forms).

- 10.27 (a) Spheroiditic microstructures are more stable than pearlitic ones.
- (b) Since pearlite transforms to spheroidite, the latter is more stable.

10.28 The hardness and strength of iron-carbon alloys that have microstructures consisting of  $\alpha$ -ferrite and cementite phases depend on the boundary area between the two phases. The greater this area, the harder and stronger the alloy inasmuch as these boundaries impede the motion of dislocations. Fine pearlite is harder and stronger than coarse pearlite because the alternating ferrite-cementite layers are thinner for fine, and therefore, there is more phase boundary area. The phase boundary area between the sphere-like cementite particles and the ferrite matrix is less in spheroidite than for the alternating layered microstructure found in coarse pearlite.

10.29 Two reasons why martensite is so hard and brittle are: 1) there are relatively few operable slip systems for the body-centered tetragonal crystal structure, and 2) virtually all of the carbon is in solid solution, which produces a solid-solution hardening effect.

10.30 This problem asks us to rank four iron-carbon alloys of specified composition and microstructure according to tensile strength. This ranking is as follows:

- 0.6 wt% C, fine pearlite
- 0.6 wt% C, coarse pearlite
- 0.25 wt% C, coarse pearlite
- 0.25 wt% C, spheroidite

The 0.25 wt% C, coarse pearlite is stronger than the 0.25 wt% C, spheroidite since coarse pearlite is stronger than spheroidite; the composition of the alloys is the same. The 0.6 wt% C, coarse pearlite is stronger than the 0.25 wt% C, coarse pearlite, since increasing the carbon content increases the strength. Finally, the 0.6 wt% C, fine pearlite is stronger than the 0.6 wt% C, coarse pearlite inasmuch as the strength of fine pearlite is greater than coarse pearlite because of the many more ferrite-cementite phase boundaries in fine pearlite.

10.31 This question asks for an explanation as to why the hardness of tempered martensite diminishes with tempering time (at constant temperature) and with increasing temperature (at constant tempering time). The hardness of tempered martensite depends on the ferrite-cementite phase boundary area; since these phase boundaries are barriers to dislocation motion, the greater the area the harder the alloy. The microstructure of tempered martensite consists of small sphere-like particles of cementite embedded within a ferrite matrix. As the size of the cementite particles increases, the phase boundary area diminishes, and the alloy becomes softer. Therefore, with increasing tempering time, the cementite particles grow, the phase boundary area decreases, and the hardness diminishes. As the tempering temperature is increased, the rate of cementite particle

growth also increases, and the alloy softens, again, because of the decrease in phase boundary area.

10.32 In this problem we are asked to describe the simplest heat treatment that would be required to convert a eutectoid steel from one microstructure to another. Figure 10.18 is used to solve the several parts of this problem.

(a) For martensite to spheroidite, heat to a temperature in the vicinity of 700°C (but below the eutectoid temperature), for on the order of 24 h.

(b) For spheroidite to martensite, austenitize at a temperature of about 760°C, then quench to room temperature at a rate greater than about 140°C/s.

(c) For bainite to pearlite, first austenitize at a temperature of about 760°C, then cool to room temperature at a rate less than about 35°C/s.

(d) For pearlite to bainite, first austenitize at a temperature of about 760°C, rapidly cool to a temperature between about 220°C and 540°C, and hold at this temperature for the time necessary to complete the bainite transformation (according to Figure 10.13).

(e) For spheroidite to pearlite, same as (c) above.

(f) For pearlite to spheroidite, heat at about 700°C for approximately 20 h.

(g) For tempered martensite to martensite, first austenitize at a temperature of about 760°C, and rapidly quench to room temperature at a rate greater than about 140°C/s.

(h) For bainite to spheroidite, simply heat at about 700°C for approximately 20 h.

10.33 (a) Both tempered martensite and spheroidite have sphere-like cementite particles within a ferrite matrix; however, these particles are much larger for spheroidite.

(b) Tempered martensite is harder and stronger inasmuch as there is much more ferrite-cementite phase boundary area for the smaller particles; thus, there is greater reinforcement of the ferrite phase, and more phase boundary barriers to dislocation motion.

10.34 This problem asks for Rockwell hardness values for specimens of an iron-carbon alloy of eutectoid composition that have been subjected to some of the heat treatments described in Problem 10.14.

(b) The microstructural product of this heat treatment is 100% spheroidite. According to Figure 10.21(a) the hardness of a 0.76 wt% C alloy with spheroidite is about 87 HRB (180 HB).

(d) The microstructural product of this heat treatment is 100% martensite. According to Figure 10.23, the hardness of a 0.76 wt% C alloy consisting of martensite is about 64 HRC (690 HB).

(f) The microstructural product of this heat treatment is 100% bainite. From Figure 10.22, the hardness of a 0.76 wt% C alloy consisting of bainite is about 385 HB. And, conversion from Brinell to Rockwell hardness using Figure 6.18 leads to a hardness of 36 HRC.

(g) The microstructural product of this heat treatment is 100% fine pearlite. According to Figure 10.21(a), the hardness of a 0.76 wt% C alloy consisting of fine pearlite is about 27 HRC (270 HB).

(h) The microstructural product of this heat treatment is 100% tempered martensite. According to Figure 10.26, the hardness of a water-quenched eutectoid alloy that was tempered at 315°C for one hour is about 56 HRC (560 HB).

10.35 This problem asks for estimates of Brinell hardness values for specimens of an iron-carbon alloy of composition 1.13 wt% C that have been subjected to some of the heat treatments described in Problem 10.16.

(a) The microstructural product of this heat treatment is 100% martensite. According to Figure 10.23, the hardness of a 1.13 wt% C alloy consisting of martensite is about 700 HB (by extrapolation).

(d) The microstructural product of this heat treatment is 100% spheroidite. According to Figure 10.21(a), the hardness of a 1.13 wt% C alloy consisting of spheroidite is about 190 HB (by extrapolation).

(h) The microstructural product of this heat treatment is proeutectoid cementite and fine pearlite. According to Figure 10.21(a), the hardness of a 1.13 wt% C alloy consisting of fine pearlite is about 310 HB (by extrapolation).

10.36 This problem asks for estimates of tensile strength values for specimens of an iron-carbon alloy of eutectoid composition that have been subjected to some of the heat treatments described in Problem 10.19.

(a) The microstructural product of this heat treatment is 100% martensite. According to Figure 10.23, the hardness of a 0.76 wt% C alloy is about 690 HB. For steel alloys, hardness and tensile strength are related through Equation (6.20a), and therefore

$$TS \text{ (MPa)} = 3.45 \times HB = (3.45)(690 \text{ HB}) = 2380 \text{ MPa} \quad (345,000 \text{ psi})$$

(c) The microstructural product of this heat treatment is 100% fine pearlite. According to Figure 10.21(a), the hardness of a 0.76 wt% C alloy consisting of fine pearlite is about 265 HB. Therefore, the tensile strength is

$$TS \text{ (MPa)} = 3.45 \times HB = (3.45)(265 \text{ HB}) = 915 \text{ MPa} \quad (132,500 \text{ psi})$$

10.37 For this problem we are asked to describe isothermal heat treatments required to yield specimens having several Brinell hardnesses.

(a) From Figure 10.21(a), in order for a 0.76 wt% C alloy to have a Brinell hardness of 180, the microstructure must be entirely spheroidite. Thus, utilizing the isothermal transformation diagram for this alloy, Figure 10.13, we must rapidly cool to a temperature at which pearlite forms (i.e., to

between 540° C and 660°C), allow the specimen to isothermally and completely transform to pearlite, cool to room temperature, and then reheat to about 700°C for 18 to 24 h.

(b) This portion of the problem asks for a hardness of 220 HB. According to Figure 10.21(a), for an alloy of this composition to have this hardness, the microstructure would have to be intermediate between coarse and fine pearlite—that is, medium pearlite. Thus, an isothermal heat treatment is necessary at a temperature in between those at which fine and coarse pearlites form—for example, about 630°C. At this temperature, an isothermal heat treatment for at least 25 s is required.

(c) In order to produce a Brinell hardness of 500, the microstructure could consist of either (1) 100% bainite (Figure 10.22), or (2) tempered martensite (Figure 10.26).

For case (1), according to Figure 10.22, bainite having a hardness of 500 HB results from an isothermal treatment that is carried out at 320°C. Therefore, after austenitizing, rapidly cool to 320°C, and, from Figure 10.13, hold the specimen at this temperature for at least 1000 seconds in order for the attainment of 100% bainite. This is followed by cooling to room temperature.

For case (2), after austenitizing, rapidly cool to room temperature in order to achieve 100% martensite. Then temper this martensite for about 150 s at 425°C (Figure 10.26).

10.38 The (a) and (b) portions of the problem ask that we make schematic plots on the same graph for the tensile strength versus composition for copper-silver alloys at both room temperature and 600°C; such a graph is shown below.

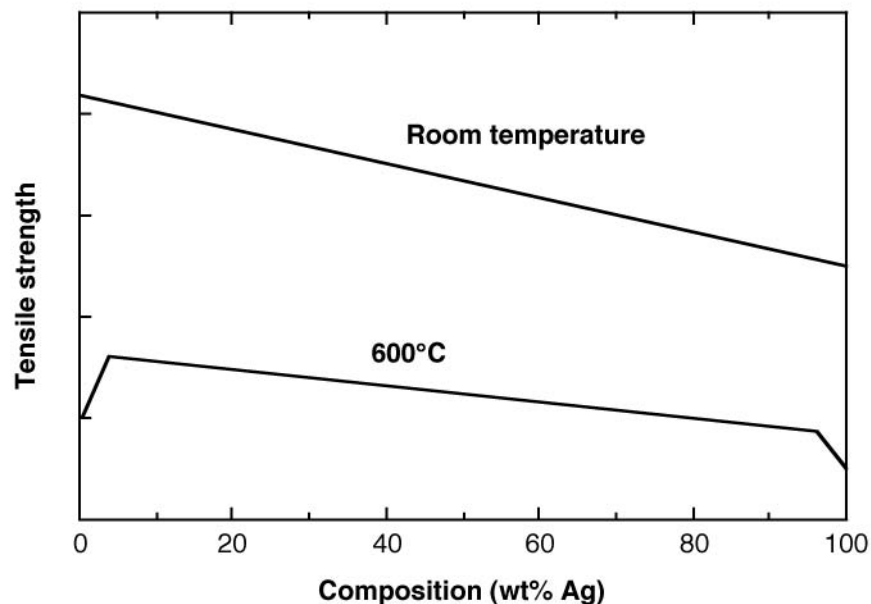

(c) Upon consultation of the Cu-Ag phase diagram (Figure 9.6) we note that at room temperature (20°C), silver is virtually insoluble in copper (i.e., by extrapolation of the solvus curve, there is no  $\alpha$  phase region at the left extremity of the phase diagram); the same may be said the solubility of



copper in silver and for the  $\beta$  phase. Thus, only the  $\alpha$  and  $\beta$  phases will exist for all compositions at room temperature; in other words, there will be no solid solution strengthening effects at room temperature. All other things being equal, the tensile strength will depend (approximately) on the tensile strengths of each of the  $\alpha$  and  $\beta$  phases as well as their phase fractions in a manner described by the equation given in Problem 9.67 for the elastic modulus. That is, for this problem

$$(TS)_{\text{alloy}} \cong (TS)_{\alpha} V_{\alpha} + (TS)_{\beta} V_{\beta}$$

in which **TS** and **V** denote tensile strength and volume fraction, respectively, and the subscripts represent the alloy/phases. Also, mass fractions of the  $\alpha$  and  $\beta$  phases change linearly with changing composition (according to the lever rule). Furthermore, inasmuch as the densities of both Cu and Ag are similar, weight and volume fractions of the  $\alpha$  and  $\beta$  phases will also be similar [see Equation (9.6)]. In summary, the previous discussion explains the linear dependence of the room temperature tensile strength on composition as represented in the above plot given that the **TS** of pure copper is greater than for pure silver (as stipulated in the problem statement).

At 600°C, the curve will be shifted to significantly lower tensile strengths inasmuch as tensile strength diminishes with increasing temperature (Section 6.6, Figure 6.14). In addition, according to Figure 9.6, about 4% of silver will dissolve in copper (i.e., in the  $\alpha$  phase), and about 4% of copper will dissolve in silver (i.e., in the  $\beta$  phase) at 600°C. Therefore, solid solution strengthening will occur over these compositions ranges, as noted in the graph shown above. Furthermore, between 4% Ag and 96% Ag, the curve will be approximately linear for the same reasons noted in the previous paragraph.

### Design Problems

10.D1 This problem inquires as to the possibility of producing an iron-carbon alloy of eutectoid composition that has a minimum hardness of 200 HB and a minimum ductility of 25%RA. If the alloy is possible, then the continuous cooling heat treatment is to be stipulated.

According to Figures 10.21(a) and (b), the following is a tabulation of Brinell hardnesses and percents reduction of area for fine and coarse pearlites and spheroidite for a 0.76 wt% C alloy.

<u>Microstructure</u>	<u>HB</u>	<u>%RA</u>
Fine pearlite	270	22
Coarse pearlite	205	29

Therefore, coarse pearlite meets both of these criteria. The continuous cooling heat treatment which will produce coarse pearlite for an alloy of eutectoid composition is indicated in Figure 10.18. The cooling rate would need to be considerably less than 35°C/s, probably on the order of 0.1°C/s.

10.D2 This problem asks if it is possible to produce an iron-carbon alloy that has a minimum tensile strength of 620 MPa (90,000 psi) and a minimum ductility of 50%RA. If such an alloy is possible, its composition and microstructure are to be stipulated.

From Equation (6.20a), this tensile strength corresponds to a Brinell hardness of

$$HB = \frac{TS(\text{MPa})}{3.45} = \frac{620 \text{ MPa}}{3.45} = 180$$

According to Figures 10.21(a) and (b), the following is a tabulation of the composition ranges for fine and coarse pearlites and spheroidite which meet the stipulated criteria.

<u>Microstructure</u>	Compositions for <u>HB ≥ 180</u>	Compositions for <u>%RA ≥ 50%</u>
Fine pearlite	> 0.38 %C	< 0.36 %C
Coarse pearlite	> 0.47 %C	< 0.42 %C
Spheroidite	> 0.80 %C	0-1.0 %C

Therefore, only spheroidite has a composition range overlap for both of the hardness and ductility restrictions; the spheroidite would necessarily have to have a carbon content greater than 0.80 wt% C.

10.D3 This problem inquires as to the possibility of producing an iron-carbon alloy having a minimum hardness of 200 HB and a minimum ductility of 35%RA. The composition and microstructure are to be specified; possible microstructures include fine and coarse pearlites and spheroidite.

To solve this problem, we must consult Figures 10.21(a) and (b). The following is a tabulation of the composition ranges for fine and coarse pearlites and spheroidite which meet the stipulated criteria.

<u>Microstructure</u>	Compositions for <u>HB ≥ 200</u>	Compositions for <u>%RA ≥ 35%</u>
-----------------------	-------------------------------------	--------------------------------------

Fine pearlite	> 0.45 %C	< 0.54 %C
Coarse pearlite	> 0.67 %C	< 0.64 %C
Spheroidite	not possible	<1.0 %C

Thus, fine pearlite is the only possibility. Its composition would need to be between 0.45 and 0.54 wt% C. A spheroidite microstructure is not possible since a hardness of 200 HB is not attainable. Furthermore, coarse pearlite is not possible because there is not a composition overlap for both hardness and ductility restrictions.

10.D4 This problem asks us to consider the tempering of a water-quenched 1080 steel to achieve a hardness of 50 HRC. It is necessary to use Figure 10.26.

(a) The time necessary at 425°C is about 650 s.

(b) At 315°C, the time required (by extrapolation) is approximately  $4 \times 10^6$  s (about 50 days).

10.D5 We are to consider the tempering of an oil-quenched 4340 steel. From Figure 10.25, for a minimum tensile strength of 1380 MPa (200,000 psi) a tempering temperature of less than 450°C (840°F) is required. Also, for a minimum ductility of 43%RA, tempering must be carried out at a temperature greater than 400°C (760°F). Therefore, tempering must occur at between 400 and 450°C (750 and 840°F) for 1 h.

10.D6 This problem asks if it is possible to produce an oil-quenched and tempered 4340 steel that has a minimum yield strength of 1240 MPa (180,000 psi) and a minimum ductility of 50%RA, and, if possible, to describe the tempering heat treatment. In Figure 10.25 is shown the tempering characteristics of this alloy. According to this figure, in order to achieve a minimum yield strength of 1240 MPa a tempering temperature of less than about 475°C is required. On the other hand, tempering must be carried out at greater than about 520°C for a minimum ductility of 50%RA. Since there is no overlap of these temperature ranges, an oil-quenched and tempered 4340 alloy possessing these characteristics is not possible.

## CHAPTER 11

### APPLICATIONS AND PROCESSING OF METAL ALLOYS

#### PROBLEM SOLUTIONS

11.1 This question asks that we list four classifications of steels, and, for each, to describe properties and cite typical applications.

##### Low-Carbon Steels

Properties: nonresponsive to heat treatments; relatively soft and weak; machinable and weldable.

Typical applications: automobile bodies, structural shapes, pipelines, buildings, bridges, and tin cans.

##### Medium-Carbon Steels

Properties: heat treatable, relatively large combinations of mechanical characteristics.

Typical applications: railway wheels and tracks, gears, crankshafts, and machine parts.

##### High-Carbon Steels

Properties: hard, strong, and relatively brittle.

Typical applications: chisels, hammers, knives, and hacksaw blades.

##### High-Alloy Steels (Stainless and Tool)

Properties: hard and wear resistant; resistant to corrosion in a large variety of environments.

Typical applications: cutting tools, drills, cutlery, food processing, and surgical tools.

11.2 (a) Ferrous alloys are used extensively because:

- 1) Iron ores exist in abundant quantities.
- 2) Economical extraction, refining, and fabrication techniques are available.
- 3) The alloys may be tailored to have a wide range of properties.

(b) Disadvantages of ferrous alloys are:

- 1) They are susceptible to corrosion.
- 2) They have relatively high densities.
- 3) They have relatively low electrical conductivities.

11.3 Ferritic and austenitic stainless steels are not heat treatable since "heat treatable" is taken to mean that martensite may be made to form with relative ease upon quenching austenite from an elevated temperature.

For ferritic stainless steels, austenite does not form upon heating, and, therefore, the austenite-to-martensite transformation is not possible.

For austenitic stainless steels, the austenite phase field extends to such low temperatures that the martensitic transformation does not occur.

11.4 The alloying elements in tool steels (e.g., Cr, V, W, and Mo) combine with the carbon to form very hard and wear-resistant carbide compounds.

11.5 We are asked to compute the volume percent graphite in a 3.5 wt% C cast iron. It first becomes necessary to compute mass fractions using the lever rule. From the iron-carbon phase diagram (Figure 11.2), the tie-line in the  $\alpha$  and graphite phase field extends from essentially 0 wt% C to 100 wt% C. Thus, for a 3.5 wt% C cast iron

$$W_{\alpha} = \frac{C_{\text{Gr}} - C_0}{C_{\text{Gr}} - C_{\alpha}} = \frac{100 - 3.5}{100 - 0} = 0.965$$

$$W_{\text{Gr}} = \frac{C_0 - C_{\alpha}}{C_{\text{Gr}} - C_{\alpha}} = \frac{3.5 - 0}{100 - 0} = 0.035$$

Conversion from weight fraction to volume fraction of graphite is possible using Equation (9.6a) as

$$\begin{aligned} V_{\text{Gr}} &= \frac{\frac{W_{\text{Gr}}}{\rho_{\text{Gr}}}}{\frac{W_{\alpha}}{\rho_{\alpha}} + \frac{W_{\text{Gr}}}{\rho_{\text{Gr}}}} \\ &= \frac{\frac{0.035}{2.3 \text{ g/cm}^3}}{\frac{0.965}{7.9 \text{ g/cm}^3} + \frac{0.035}{2.3 \text{ g/cm}^3}} \\ &= 0.111 \text{ or } 11.1 \text{ vol\%} \end{aligned}$$

11.6 Gray iron is weak and brittle in tension because the tips of the graphite flakes act as points of stress concentration.

11.7 This question asks us to compare various aspects of gray and malleable cast irons.

(a) With respect to composition and heat treatment:

**Gray iron**--2.5 to 4.0 wt% C and 1.0 to 3.0 wt% Si. For most gray irons there is no heat treatment after solidification.

**Malleable iron**--2.5 to 4.0 wt% C and less than 1.0 wt% Si. White iron is heated in a nonoxidizing atmosphere and at a temperature between 800 and 900°C for an extended time period.

(b) With respect to microstructure:

**Gray iron**--Graphite flakes are embedded in a ferrite or pearlite matrix.

**Malleable iron**--Graphite clusters are embedded in a ferrite or pearlite matrix.

(c) With respect to mechanical characteristics:

**Gray iron**--Relatively weak and brittle in tension; good capacity for damping vibrations.

**Malleable iron**--Moderate strength and ductility.

11.8 Yes, it is possible to produce cast irons that consist of a martensite matrix in which graphite is embedded in either flake, nodule, or rosette form. For graphite flakes, gray cast iron is formed (as described in Section 11.2), which is then heated to a temperature at which the ferrite transforms to austenite; the austenite is then rapidly quenched, which transforms to martensite. For graphite nodules and rosettes, nodular and malleable cast irons are first formed (again as described in Section 11.2), which are then austenitized and rapidly quenched.

11.9 This question asks us to compare white and nodular cast irons.

(a) With regard to composition and heat treatment:

**White iron**--2.5 to 4.0 wt% C and less than 1.0 wt% Si. No heat treatment; however, cooling is rapid during solidification.

**Nodular cast iron**--2.5 to 4.0 wt% C, 1.0 to 3.0 wt% Si, and a small amount of Mg or Ce. A heat treatment at about 700°C may be necessary to produce a ferritic matrix.

(b) With regard to microstructure:

**White iron**--There are regions of cementite interspersed within pearlite.

**Nodular cast iron**--Nodules of graphite are embedded in a ferrite or pearlite matrix.

(c) With respect to mechanical characteristics:

**White iron**--Extremely hard and brittle.

**Nodular cast iron**--Moderate strength and ductility.

11.10 It is not possible to produce malleable iron in pieces having large cross-sectional dimensions. White cast iron is the precursor of malleable iron, and a rapid cooling rate is necessary for the formation of white iron, which may not be accomplished at interior regions of thick cross-sections.

- 11.11 The principal difference between wrought and cast alloys is as follows: wrought alloys are ductile enough so as to be hot- or cold-worked during fabrication, whereas cast alloys are brittle to the degree that shaping by deformation is not possible and they must be fabricated by casting.
- 11.12 Both brasses and bronzes are copper-based alloys. For brasses, the principal alloying element is zinc, whereas the bronzes are alloyed with other elements such as tin, aluminum, silicon, or nickel.
- 11.13 Rivets of a 2017 aluminum alloy must be refrigerated before they are used because, after being solution heat treated, they precipitation harden at room temperature. Once precipitation hardened, they are too strong and brittle to be driven.
- 11.14 Strengthening of a 3003 aluminum alloy is accomplished by cold working. Welding a structure of a cold-worked 3003 alloy will cause it to experience recrystallization, and a resultant loss of strength.
- 11.15 The chief difference between heat-treatable and nonheat-treatable alloys is that heat-treatable alloys may be strengthened by a heat treatment wherein a precipitate phase is formed (precipitation hardening) or a martensitic transformation occurs. Nonheat-treatable alloys are not amenable to strengthening by such treatments.
- 11.16 This question asks us for the distinctive features, limitations, and applications of several alloy groups.

#### Titanium Alloys

Distinctive features: relatively low densities, high melting temperatures, and high strengths are possible.

Limitation: because of chemical reactivity with other materials at elevated temperatures, these alloys are expensive to refine.

Applications: aircraft structures, space vehicles, and in chemical and petroleum industries.

#### Refractory Metals

Distinctive features: extremely high melting temperatures; large elastic moduli, hardnesses, and strengths.

Limitation: some experience rapid oxidation at elevated temperatures.

Applications: extrusion dies, structural parts in space vehicles, incandescent light filaments, x-ray tubes, and welding electrodes.

#### Superalloys

Distinctive features: able to withstand high temperatures and oxidizing atmospheres for long time periods.

Applications: aircraft turbines, nuclear reactors, and petrochemical equipment.

#### Noble Metals

Distinctive features: highly resistant to oxidation, especially at elevated temperatures; soft and ductile.

Limitation: expensive.

Applications: jewelry, dental restoration materials, coins, catalysts, and thermocouples.

11.17 The advantages of cold working are:

- 1) A high quality surface finish.
- 2) The mechanical properties may be varied.
- 3) Close dimensional tolerances.

The disadvantages of cold working are:

- 1) High deformation energy requirements.
- 2) Large deformations must be accomplished in steps, which may be expensive.
- 3) A loss of ductility.

The advantages of hot working are:

- 1) Large deformations are possible, which may be repeated.
- 2) Deformation energy requirements are relatively low.

The disadvantages of hot working are:

- 1) A poor surface finish.
- 2) A variety of mechanical properties is not possible.

11.18 (a) The advantages of extrusion over rolling are as follows:

- 1) Pieces having more complicated cross-sectional geometries may be formed.
- 2) Seamless tubing may be produced.

(b) The disadvantages of extrusion over rolling are as follows:

- 1) Nonuniform deformation over the cross-section.
- 2) A variation in properties may result over the cross-section of an extruded piece.

11.19 Four situations in which casting is the preferred fabrication technique are:

- 1) For large pieces and/or complicated shapes.
- 2) When mechanical strength is not an important consideration.
- 3) For alloys having low ductilities.
- 4) When it is the most economical fabrication technique.

11.20 This question asks us to compare sand, die, investment, and continuous casting techniques.



For **sand casting**, sand is the mold material, a two-piece mold is used, ordinarily the surface finish is not an important consideration, the sand may be reused (but the mold may not), casting rates are low, and large pieces are usually cast.

For **die casting**, a permanent mold is used, casting rates are high, the molten metal is forced into the mold under pressure, a two-piece mold is used, and small pieces are normally cast.

For **investment casting**, a single-piece mold is used, which is not reusable; it results in high dimensional accuracy, good reproduction of detail, and a fine surface finish; and casting rates are low.

For **continuous casting**, at the conclusion of the extraction process, the molten metal is cast into a continuous strand having either a rectangular or circular cross-section; these shapes are desirable for subsequent secondary metal-forming operations. The chemical composition and mechanical properties are relatively uniform throughout the cross-section.

11.21 (a) Some of the advantages of powder metallurgy over casting are as follows:

- 1) It is used for alloys having high melting temperatures.
- 2) Better dimensional tolerances result.
- 3) Porosity may be introduced, the degree of which may be controlled (which is desirable in some applications such as self-lubricating bearings).

(b) Some of the disadvantages of powder metallurgy over casting are as follows:

- 1) Production of the powder is expensive.
- 2) Heat treatment after compaction is necessary.

11.22 This question asks for the principal differences between welding, brazing, and soldering.

For welding, there is melting of the pieces to be joined in the vicinity of the bond; a filler material may or may not be used.

For brazing, a filler material is used which has a melting temperature in excess of about 425°C (800°F); the filler material is melted, whereas the pieces to be joined are not melted.

For soldering, a filler material is used which has a melting temperature less than about 425°C (800°F); the filler material is melted, whereas the pieces to be joined are not.

11.23 This problem asks that we specify and compare the microstructures and mechanical properties in the heat-affected weld zones for 1080 and 4340 alloys assuming that the average cooling rate is 10°C/s. Figure 10.18 shows the continuous cooling transformation diagram for an iron-carbon alloy of eutectoid composition (1080), and, in addition, cooling curves that delineate changes in microstructure. For a cooling rate of 10°C/s (which is less than 35°C/s) the resulting microstructure will be totally pearlite--probably a reasonably fine pearlite. On the other hand, in Figure 10.19 is

shown the CCT diagram for a 4340 steel. From this diagram it may be noted that a cooling rate of 10°C/s produces a totally martensitic structure. Pearlite is softer and more ductile than martensite, and, therefore, is most likely more desirable.

11.24 If a steel weld is cooled very rapidly, martensite may form, which is very brittle. In some situations, cracks may form in the weld region as it cools.

11.25 Full annealing--Heat to between 15 and 40°C above the  $A_3$  line (if the concentration of carbon is less than the eutectoid) or above the  $A_1$  line (if the concentration of carbon is greater than the eutectoid) until the alloy comes to equilibrium; then furnace cool to room temperature. The final microstructure is coarse pearlite.

Normalizing--Heat to between 55 and 85°C above the upper critical temperature until the specimen has fully transformed to austenite, then cool in air. The final microstructure is fine pearlite.

Quenching--Heat to a temperature within the austenite phase region and allow the specimen to fully austenitize, then quench to room temperature in oil or water. The final microstructure is martensite.

Tempering--Heat a quenched (martensitic) specimen, to a temperature between 450 and 650°C, for the time necessary to achieve the desired hardness. The final microstructure is tempered martensite.

11.26 Three sources of residual stresses in metal components are plastic deformation processes, nonuniform cooling of a piece that was cooled from an elevated temperature, and a phase transformation in which parent and product phases have different densities.

Two adverse consequences of these stresses are distortion (or warpage) and fracture.

11.27 This question asks that we cite the temperature range over which it is desirable to austenitize several iron-carbon alloys during a normalizing heat treatment.

(a) For 0.20 wt% C, heat to between 890 and 920°C (1635 and 1690°F) since the  $A_3$  temperature is 835°C (1535°F).

(b) For 0.76 wt% C, heat to between 782 and 812°C (1440 and 1494°F) since the  $A_3$  temperature is 727°C (1340°F).

(c) For 0.95 wt% C, heat to between 840 and 870°C (1545 and 1600°F) since  $A_{cm}$  is 785°C (1445°F).

11.28 We are asked for the temperature range over which several iron-carbon alloys should be austenitized during a full-anneal heat treatment.

- (a) For 0.25 wt% C, heat to between 845 and 870°C (1555 and 1600°F) since the  $A_3$  temperature is 830°C (1525°F).
- (b) For 0.45 wt% C, heat to between 790 and 815°C (1450 and 1500°F) since the  $A_3$  temperature is 775°C (1425°F).
- (c) For 0.85 wt% C, heat to between 742 and 767°C (1368 and 1413°F) since the  $A_1$  temperature is 727°C (1340°F).
- (d) For 1.10 wt% C, heat to between 742 and 767°C (1368 and 1413°F) since the  $A_1$  temperature is 727°C (1340°F).

11.29 The purpose of a spheroidizing heat treatment is to produce a very soft and ductile steel alloy having a spheroiditic microstructure. It is normally used on medium- and high-carbon steels, which, by virtue of carbon content, are relatively hard and strong.

11.30 Hardness is a measure of a material's resistance to localized surface deformation, whereas hardenability is a measure of the depth to which a ferrous alloy may be hardened by the formation of martensite. Hardenability is determined from hardness tests.

11.31 The presence of alloying elements (other than carbon) causes a much more gradual decrease in hardness with position from the quenched end for a hardenability curve. The reason for this effect is that alloying elements retard the formation of pearlitic and bainitic structures which are not as hard as martensite.

11.32 A decrease of austenite grain size will decrease the hardenability. Pearlite normally nucleates at grain boundaries, and the smaller the grain size, the greater the grain boundary area, and, consequently, the easier it is for pearlite to form.

11.33 The three factors that influence the degree to which martensite is formed are as follows:

- 1) Alloying elements; adding alloying elements increases the extent to which martensite forms.
- 2) Specimen size and shape; the extent of martensite formation increases as the specimen cross-section decreases and as the degree of shape irregularity increases.
- 3) Quenching medium; the more severe the quench, the more martensite is formed. Water provides a more severe quench than does oil, which is followed by air. Agitating the medium also enhances the severity of quench.

11.34 The two thermal properties of a liquid medium that influence its quenching effectiveness are thermal conductivity and heat capacity.

11.35 (a) This part of the problem calls for us to construct a radial hardness profile for a 50 mm (2 in.) diameter cylindrical specimen of an 8640 steel that has been quenched in moderately agitated oil. In the manner of Example Problem 11.1, the equivalent distances and hardnesses tabulated below were determined from Figures 11.13 and 11.16(b).

<u>Radial Position</u>	<u>Equivalent Distance, mm (in.)</u>	<u>HRC Hardness</u>
Surface	7 (5/16)	54
3/4 R	11 (7/16)	50
Midradius	14 (9/16)	45
Center	16 (10/16)	44

The resulting profile is plotted here.

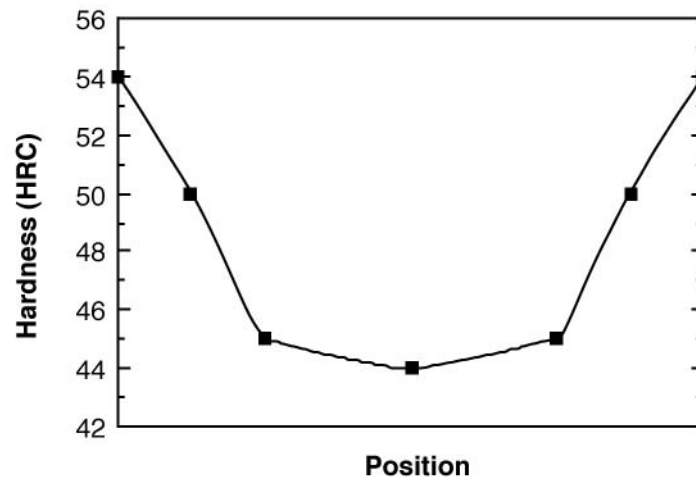

(b) The radial hardness profile for a 75 mm (3 in.) diameter specimen of a 5140 steel that has been quenched in moderately agitated oil is desired. The equivalent distances and hardnesses for the various radial positions, as determined using Figures 11.13 and 11.16(b), are tabulated below.

<u>Radial Position</u>	<u>Equivalent Distance, mm (in.)</u>	<u>HRC Hardness</u>
Surface	13 (1/2)	41
3/4 R	19 (3/4)	35
Midradius	22 (14/16)	33
Center	25 (1)	31

The resulting profile is plotted here.

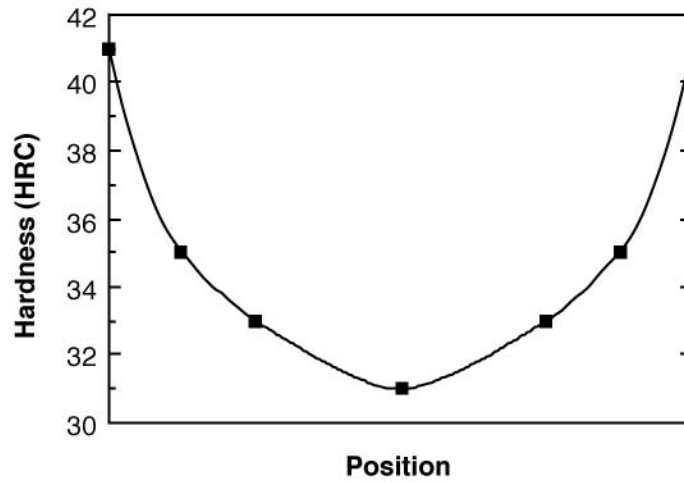

(c) The radial hardness profile for a 90 mm (3-1/2 in.) diameter specimen of an 8630 steel that has been quenched in moderately agitated water is desired. The equivalent distances and hardnesses for the various radial positions, as determined using Figures 11.14 and 11.16(a) are tabulated below.

<u>Radial Position</u>	<u>Equivalent Distance, in. (mm)</u>	<u>HRC Hardness</u>
Surface	3 (1/8)	50
3/4 R	10 (3/8)	38
Midradius	17 (11/16)	30
Center	20 (13/16)	28

The resulting profile is plotted here.

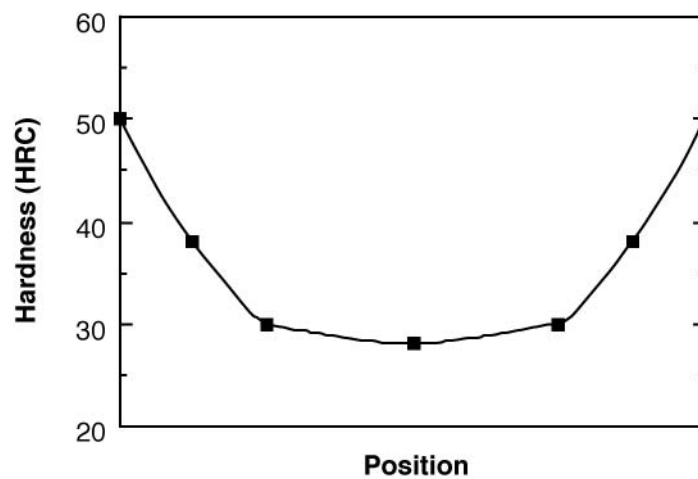

(d) The radial hardness profile for a 100 mm (4 in.) diameter specimen of a 8660 steel that has been quenched in moderately agitated water is desired. The equivalent distances and hardnesses for the various radial positions, as determined using Figures 11.14 and 11.16(a), are tabulated below.

<u>Radial Position</u>	<u>Equivalent Distance, in. (mm)</u>	<u>HRC Hardness</u>
Surface	3 (1/8)	63
3/4 R	11 (7/16)	61
Midradius	20 (13/16)	57
Center	27 (1-1/16)	53

The resulting profile is plotted here.

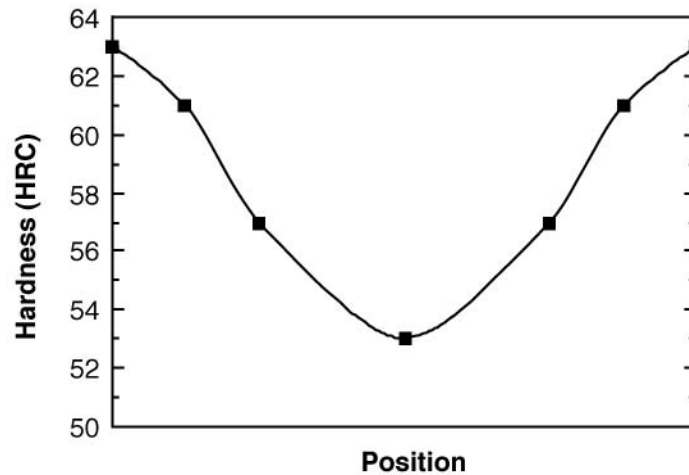

11.36 We are asked to compare the effectiveness of quenching in moderately agitated water and oil by graphing, on a single plot, the hardness profiles for 75 mm (3 in.) diameter cylindrical specimens of an 8640 steel that had been quenched in both media.

For moderately agitated water, the equivalent distances and hardnesses for the several radial positions [Figures 11.16(a) and 11.13] are tabulated below.

<u>Radial Position</u>	<u>Equivalent Distance, mm</u>	<u>HRC Hardness</u>
Surface	3	56
3/4 R	9	53
Midradius	13.5	47
Center	16.5	43

While for moderately agitated oil, the equivalent distances and hardnesses for the several radial positions [Figures 11.16(b) and 11.13] are tabulated below.

<u>Radial Position</u>	<u>Equivalent Distance, mm</u>	<u>HRC Hardness</u>
Surface	13	48
3/4 R	19	41
Midradius	22	38
Center	25	37

These data are plotted here.

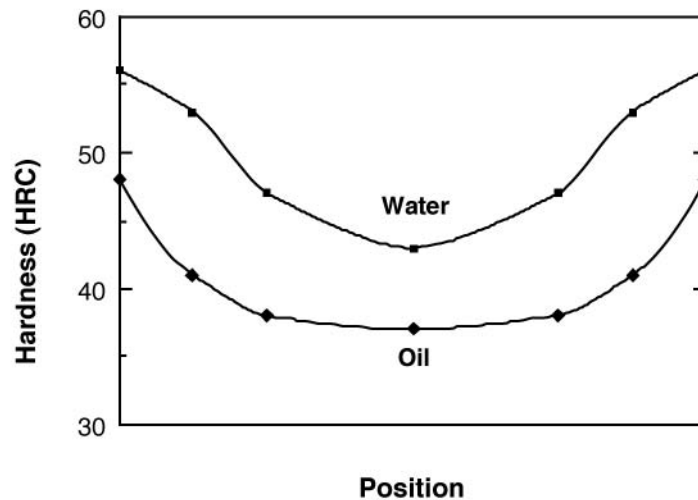

11.37 This problem asks us to compare various aspects of precipitation hardening, and the quenching and tempering of steel.

(a) With regard to the total heat treatment procedure, the steps for the **hardening of steel** are as follows:

- 1) Austenitize above the upper critical temperature.
- 2) Quench to a relatively low temperature.
- 3) Temper at a temperature below the eutectoid.
- 4) Cool to room temperature.

With regard to **precipitation hardening**, the steps are as follows:

- 1) Solution heat treat by heating into the solid solution phase region.
- 2) Quench to a relatively low temperature.
- 3) Precipitation harden by heating to a temperature that is within the solid two-phase region.

4) Cool to room temperature.

(b) For the **hardening of steel**, the microstructures that form at the various heat treating stages in part (a) are:

- 1) Austenite
- 2) Martensite
- 3) Tempered martensite
- 4) Tempered martensite

For **precipitation hardening**, the microstructures that form at the various heat treating stages in part (a) are:

- 1) Single phase
- 2) Single phase--supersaturated
- 3) Small plate-like particles of a new phase within a matrix of the original phase.
- 4) Same as 3)

(c) For the **hardening of steel**, the mechanical characteristics for the various steps in part (a) are as follows:

- 1) Not important
- 2) The steel becomes hard and brittle upon quenching.
- 3) During tempering, the alloy softens slightly and becomes more ductile.
- 4) No significant changes upon cooling to or maintaining at room temperature.

For **precipitation hardening**, the mechanical characteristics for the various steps in part (a) are as follows:

- 1) Not important
- 2) The alloy is relatively soft.
- 3) The alloy hardens with increasing time (initially), and becomes more brittle; it may soften with overaging.
- 4) The alloy may continue to harden or overage at room temperature.

11.38 For precipitation hardening, natural aging is allowing the precipitation process to occur at the ambient temperature; artificial aging is carried out at an elevated temperature.

### Design Problems

11.D1 This problem calls for us to select, from a list, the best alloy for each of several applications and then to justify each choice.



- (a) Gray cast iron would be the best choice for a milling machine base because it effectively absorbs vibrations and is inexpensive.
- (b) Stainless steel would be the best choice for the walls of a steam boiler because it is corrosion resistant to the steam and condensate.
- (c) Titanium alloys are the best choice for high-speed aircraft because they are light weight, strong, and easily fabricated. However, one drawback is their cost.
- (d) A tool steel would be the best choice for a drill bit because it is very hard and wear resistant, and, thus, will retain a sharp cutting edge.
- (e) For a cryogenic (low-temperature) container, an aluminum alloy would be the best choice; aluminum alloys have the FCC crystal structure, and therefore, are ductile down to very low temperatures.
- (f) As a pyrotechnic in flares and fireworks, magnesium is the best choice because it ignites easily and burns readily in air.
- (g) Platinum is the best choice for high-temperature furnace elements to be used in oxidizing atmospheres because it is very ductile, has a relatively high melting temperature, and is highly resistant to oxidation.

- 11.D2 (a) Important characteristics required of metal alloys that are used for coins are as follows: they must be hard, somewhat ductile, corrosion and oxidation resistant, and nontoxic.
- (b) Some of the metals and alloys that are used and have been used for coins are gold, silver, copper, nickel, copper-nickel alloys, and brass alloys.

11.D3 The first part of this question asks for a description of the shape memory phenomenon. A part having some shape and that is fabricated from a metal alloy that displays this phenomenon is plastically deformed. It can be made to return to its original shape by heating to an elevated temperature. Thus, the material has a shape memory, or "remembers" its previous shape.

Next we are asked to explain the mechanism for this phenomenon. A shape memory alloy is polymorphic (Section 3.6)--that is, it can exist having two crystal structures. One is body-centered cubic structure (termed an austenite phase) that exists at elevated temperatures; upon cooling, and at some temperature above the ambient, it transforms to a martensitic structure. Furthermore, this martensitic phase is highly twinned. Upon application of a stress to this low-temperature martensitic phase, plastic deformation is accomplished by the migration of twin boundaries to some preferred orientation. Once the stress is removed, the deformed shape will be retained at this temperature. When this deformed martensite is subsequently heated to above the phase transformation temperature, the alloy reverts back to the BCC phase, and assumes the original shape. The procedure may then be repeated.

One material that exhibits this behavior is a nickel-titanium alloy. Furthermore, the desired "memory" shape may be established by forming the material above its phase transition temperature.

Several applications for alloys displaying this effect are eyeglass frames, shrink-to-fit pipe couplers, tooth-straightening braces, collapsible antennas, greenhouse window openers, antiscald control valves on showers, women's foundations, and fire sprinkler valves.

11.D4 (a) Compositionally, the metallic glass materials are rather complex; several compositions are as follows:  $\text{Fe}_{80}\text{B}_{20}$ ,  $\text{Fe}_{72}\text{Cr}_8\text{P}_{13}\text{C}_7$ ,  $\text{Fe}_{67}\text{Co}_{18}\text{B}_{14}\text{Si}$ ,  $\text{Pd}_{77.5}\text{Cu}_{6.0}\text{Si}_{16.5}$ , and  $\text{Fe}_{40}\text{Ni}_{38}\text{Mo}_4\text{B}_{18}$ .

(b) These materials are exceptionally strong and tough, extremely corrosion resistant, and are easily magnetized.

(c) Principal drawbacks for these materials are 1) complicated and exotic fabrication techniques are required; and 2) inasmuch as very rapid cooling rates are required, at least one dimension of the material must be small--i.e., they are normally produced in ribbon form.

(d) Potential uses include transformer cores, magnetic amplifiers, heads for magnetic tape players, reinforcements for pressure vessels and tires, shields for electromagnetic interference, security tapes for library books.

(e) Production techniques include centrifuge melt spinning, planar-flow casting, rapid pressure application, arc melt spinning.

11.D5 This question provides us with a list of several metal alloys, and then asks us to pick those that may be strengthened by heat treatment, by cold work, or both. Those alloys that may be heat treated are either those noted as "heat treatable" (Tables 11.6 through 11.9), or as martensitic stainless steels (Table 11.4). Alloys that may be strengthened by cold working must not be exceptionally brittle, and, furthermore, must have recrystallization temperatures above room temperature (which immediately eliminates lead).

<u>Heat Treatable</u>	<u>Cold Workable</u>	<u>Both</u>
6150 Steel	6150 Steel	6150 Steel
C17200 Be-Cu	C17200 Be-Cu	C17200 Be-Cu
6061 Al	6061 Al	6061 Al
	304 Stainless Steel	
	R50500 Ti	
	C51000 Phosphor Bronze	
	AZ31B Mg	

11.D6 This problem asks us to select from four alloys (brass, steel, titanium, and aluminum), the one that will support a 50,000 N (11,250 lb<sub>f</sub>) load without plastically deforming, and having the minimum weight. From Equation (6.1), the cross-sectional area ( $A_o$ ) must necessarily carry the load ( $F$ ) without exceeding the yield strength ( $\sigma_y$ ), as

$$A_o = \frac{F}{\sigma_y}$$

Now, given the length  $l$ , the volume of material required ( $V$ ) is just

$$V = lA_o = \frac{lF}{\sigma_y}$$

Finally, the mass of the member ( $m$ ) is

$$m = V\rho = \frac{\rho lF}{\sigma_y}$$

in which  $\rho$  is the density. Using the values given for these alloys

$$m(\text{brass}) = \frac{(8.5 \text{ g/cm}^3)(10 \text{ cm})(50,000 \text{ N})}{(415 \times 10^6 \text{ N/m}^2)\left(\frac{1 \text{ m}}{10^2 \text{ cm}}\right)^2} = 102 \text{ g}$$

$$m(\text{steel}) = \frac{(7.9 \text{ g/cm}^3)(10 \text{ cm})(50,000 \text{ N})}{(860 \times 10^6 \text{ N/m}^2)\left(\frac{1 \text{ m}}{10^2 \text{ cm}}\right)^2} = 46 \text{ g}$$

$$m(\text{aluminum}) = \frac{(2.7 \text{ g/cm}^3)(10 \text{ cm})(50,000 \text{ N})}{(310 \times 10^6 \text{ N/m}^2)\left(\frac{1 \text{ m}}{10^2 \text{ cm}}\right)^2} = 43.5 \text{ g}$$

$$m(\text{titanium}) = \frac{(4.5 \text{ g/cm}^3)(10 \text{ cm})(50,000 \text{ N})}{(550 \times 10^6 \text{ N/m}^2)\left(\frac{1 \text{ m}}{10^2 \text{ cm}}\right)^2} = 40.9 \text{ g}$$

Thus, titanium would have the minimum weight (or mass), followed by aluminum, steel, and brass.

11.D7 This question asks for us to decide whether or not it would be advisable to hot-work or cold-work several metals and alloys.

**Tin** would almost always be hot-worked. Even deformation at room temperature would be considered hot-working inasmuch as its recrystallization temperature is below room temperature (Table 7.2).

**Tungsten** is hard and strong at room temperature, has a high recrystallization temperature, and experiences oxidation at elevated temperatures. Cold-working is difficult because of its strength, and hot-working is not practical because of oxidation problems. Most tungsten articles are fabricated by powder metallurgy, or by using cold-working followed by annealing cycles.

Most **aluminum alloys** may be cold-worked since they are ductile and have relatively low yield strengths.

**Magnesium alloys** are normally hot-worked inasmuch as they are quite brittle at room temperature. Also, magnesium alloys have relatively low recrystallization temperatures.

A **4140 steel** could be cold-worked in an over-tempered state which leaves it soft and relatively ductile, after which quenching and tempering heat treatments may be employed to strengthen and harden it. This steel would probably have a relatively high recrystallization temperature, and hot-working may cause oxidation.

11.D8 A one-inch diameter steel specimen is to be quenched in moderately agitated oil. We are to decide which of five different steels will have surface and center hardnesses of at least 55 and 50 HRC, respectively.

In moderately agitated oil, the equivalent distances from the quenched end for a one-inch diameter bar for surface and center positions are 3 mm (1/8 in.) and 8 mm (11/32 in.), respectively [Figure 11.16(b)]. The hardnesses at these two positions for the alloys cited (as determined using Figure 11.13) are given below.

<u>Alloy</u>	<u>Surface Hardness (HRC)</u>	<u>Center Hardness (HRC)</u>
1040	50	30
5140	55	47
4340	57	57
4140	56	54
8640	56	52.5

Thus, alloys 4340, 4140, and 8640 will satisfy the criteria for both surface and center hardnesses.

11.D9 (a) This problem calls for us to decide which of 8660, 8640, 8630, and 8620 alloys may be fabricated into a cylindrical piece 57 mm (2-1/4 in.) in diameter which, when quenched in mildly agitated water, will produce a minimum hardness of 45 HRC throughout the entire piece.

The center of the steel cylinder will cool the slowest and therefore will be the softest. In moderately agitated water the equivalent distance from the quenched end for a 57 mm diameter bar for the center position is about 11 mm (7/16 in.) [Figure 11.16(a)]. The hardnesses at this position for the alloys cited (Figure 11.14) are given below.

<u>Alloy</u>	<u>Center Hardness (HRC)</u>
8660	61
8640	49
8630	36
8620	25

Therefore, only 8660 and 8640 alloys will have a minimum of 45 HRC at the center, and therefore, throughout the entire cylinder.

(b) This part of the problem asks us to do the same thing for moderately agitated oil. In moderately agitated oil the equivalent distance from the quenched end for a 57 mm diameter bar at the center position is about 17.5 mm (11.16 in.) [Figure 11.16(b)]. The hardnesses at this position for the alloys cited (Figure 11.14) are given below.

<u>Alloy</u>	<u>Center Hardness (HRC)</u>
8660	59
8640	42
8630	30
8620	21

Therefore, only the 8660 alloy will have a minimum of 45 HRC at the center, and therefore, throughout the entire cylinder.

11.D10 A thirty-eight millimeter diameter cylindrical steel specimen is to be heat treated such that the microstructure throughout will be at least 80% martensite. We are to decide which of several alloys will satisfy this criterion if the quenching medium is moderately agitated (a) oil, and (b) water.

(a) Since the cooling rate is lowest at the center, we want a minimum of 80% martensite at the center position. From Figure 11.16(b), the cooling rate is equal to an equivalent distance from the quenched end of 12 mm (1/2 in.). According to Figure 11.13, the hardness corresponding to 80% martensite for these alloys is 50 HRC. Thus, all we need do is to determine which of the alloys have a 50 HRC hardness at an equivalent distance from the quenched end of 12 mm (1/2 in.). At an equivalent distance of 12 mm (1/2 in.), the following hardnesses are determined from Figure 11.13 for the various alloys.

<u>Alloy</u>	<u>Hardness (HRC)</u>
4340	55
4140	52
8640	48
5140	42
1040	25

Thus, only alloys 4340 and 4140 will qualify.

(b) For moderately agitated water, the cooling rate at the center of a 38 mm diameter specimen is 8 mm (5/16 in.) equivalent distance from the quenched end [Figure 11.16(a)]. At this position, the following hardnesses are determined from Figure 11.13 for the several alloys.

<u>Alloy</u>	<u>Hardness (HRC)</u>
4340	56
4140	55
8640	54
5140	49
1040	32

It is still necessary to have a hardness of 50 HRC or greater at the center; thus, alloys 4340, 4140, and 8640 qualify.

11.D11 A fifty-millimeter (two-inch) diameter cylindrical steel specimen is to be quenched in moderately agitated water. We are to decide which of eight different steels will have surface and center hardnesses of at least 50 and 40 HRC, respectively.

In moderately agitated water, the equivalent distances from the quenched end for a 50 mm diameter bar for surface and center positions are 2 mm (1/16 in.) and 10 mm (3/8 in.), respectively [Figure 11.16(a)]. The hardnesses at these two positions for the alloys cited are given below.

<u>Alloy</u>	<u>Surface Hardness (HRC)</u>	<u>Center Hardness (HRC)</u>
1040	53	28
5140	57	46
4340	57	56
4140	57	54
8620	43	28
8630	52	38
8640	57	52
8660	64	62

Thus, alloys 5140, 4340, 4140, 8640, and 8660 will satisfy the criteria for both surface and center hardnesses.

11.D12 We are asked to determine the maximum diameter possible for a cylindrical piece of 4140 steel that is to be quenched in moderately agitated oil such that the microstructure will consist of at least 50% martensite throughout the entire piece. From Figure 11.13, the equivalent distance from the quenched end of a 4140 steel to give 50% martensite (or a 42.5 HRC hardness) is 26 mm (1-1/16 in.). Thus, the quenching rate at the center of the specimen should correspond to this equivalent distance. Using Figure 11.16(b), the center specimen curve takes on a value of 26 mm (1-1/16 in.) equivalent distance at a diameter of about 75 mm (3 in.).

11.D13 In this problem we are asked to describe a heat treatment that may be used on a 45 mm diameter steel shaft of a 1040 steel such that it will have a uniform tensile strength of at least 620 MPa across the entirety of its cross-section. First of all, if the steel is heat treated so as to produce martensite or tempered martensite, there will undoubtedly be a variation of tensile strength over the cross-section. Thus, let us determine if either martensite or tempered martensite is required to give this desired tensile strength, and, if not, what microstructure is necessary.

From Equation (6.20a) a tensile strength of 620 MPa corresponds to a Brinell hardness of about 180. Upon consultation of Figure 10.21(a), we note that for an alloy of composition of 0.40 wt% C, in order to achieve a hardness of 180 HB, a microstructure of fine pearlite is required. One possible heat treatment that may be used to produce fine pearlite is a continuous cooling one. In

Figure 10.29 is shown a continuous cooling transformation diagram for a 0.35 wt% C alloy, which would be very similar to that for a 1040 steel. According to this diagram, we would want to austenitize the alloy at approximately 900°C, and then continuously cool to room temperature such that the cooling curve would pass through the fine pearlite region of the diagram (per Figure 10.17). This would correspond to a cooling rate of approximately 3°C/s (Figure 10.18), which would probably result from air-cooling the shaft from the 900°C austenitizing temperature. For this relatively low cooling rate, the microstructure, and therefore the tensile strength, will be quite uniform across the specimen cross section.

11.D14 We are to determine, for a cylindrical piece of 8660 steel, the minimum allowable diameter possible in order yield a surface hardness of 58 HRC, when the quenching is carried out in moderately agitated oil.

From Figure 11.14, the equivalent distance from the quenched end of an 8660 steel to give a hardness of 58 HRC is about 18 mm (3/4 in.). Thus, the quenching rate at the surface of the specimen should correspond to this equivalent distance. Using Figure 11.16(b), the surface specimen curve takes on a value of 18 mm equivalent distance at a diameter of about 95 mm (3.75 in.).

11.D15 This problem is concerned with the precipitation-hardening of copper-rich Cu-Be alloys. It is necessary for us to use the Cu-Be phase diagram (Figure 11.26 ).

(a) The range of compositions over which these alloys may be precipitation hardened is between approximately 0.2 wt% Be (the maximum solubility of Be in Cu at about 300°C) and 2.7 wt% Be (the maximum solubility of Be in Cu at 866°C).

(b) The heat treatment procedure, of course, will depend on the composition chosen. First of all, the solution heat treatment must be carried out at a temperature within the  $\alpha$  phase region, after which, the specimen is quenched to room temperature. Finally, the precipitation heat treatment is conducted at a temperature within the  $\alpha + \gamma_2$  phase region.

For example, for a 1.5 wt% Be-98.5 wt% Cu alloy, the solution heat treating temperature must be between about 600°C (1110°F) and 900°C (1650°F), while the precipitation heat treatment would be below 600°C (1110°F), and probably above 300°C (570°F). Below 300°C, diffusion rates are low, and heat treatment times would be relatively long.

11.D16 We are asked to specify a practical heat treatment for a 2014 aluminum alloy that will produce a minimum yield strength of 345 MPa (50,000 psi), and a minimum ductility of 12%EL. From Figure 11.25(a), the following heat treating temperatures and time ranges are possible to give the required yield strength.



<u>Temperature (°C)</u>	<u>Time Range (h)</u>
260	not possible
204	0.3-15
149	10-700
121	300-?

With regard to temperatures and times to give the desired ductility [Figure 11.25(b)]:

<u>Temperature (°C)</u>	<u>Time Range (h)</u>
260	<0.02, >10
204	<0.4, >350
149	<20
121	<1000

From these tabulations, the following may be concluded:

It is not possible to heat treat this alloy at 260°C so as to produce the desired set of properties--there is no overlap of the two sets of time ranges.

At 204°C, the heat treating time would need to be about 0.4 h, which is practical.

At 149°C, the time range is between 10 and 20 h, which is a little on the long side.

Finally, at 121°C, the time range is unpractically long (300 to 1000 h).

11.D17 This problem inquires as to the possibility of producing a precipitation-hardened 2014 aluminum alloy having a minimum yield strength of 380 MPa (55,000 psi) and a ductility of at least 15%EL. In order to solve this problem it is necessary to consult Figures 11.25(a) and 11.25(b). Below are tabulated the times required at the various temperatures to achieve the stipulated yield strength.

<u>Temperature (°C)</u>	<u>Time Range (h)</u>
260	not possible
204	0.5-7
149	10-250
121	500-2500

With regard to temperatures and times to give the desired ductility:

<u>Temperature (°C)</u>	<u>Time Range (h)</u>
260	<0.005
204	<0.13
149	<10
121	<450

Therefore, an alloy having this combination of yield strength and ductility is marginally possible. A heat treatment at 149°C for 10 h would probably just achieve the stipulated ductility and yield strength.

## CHAPTER 12

### STRUCTURES AND PROPERTIES OF CERAMICS

#### PROBLEM SOLUTIONS

12.1 The two characteristics of component ions that determine the crystal structure are: 1) the magnitude of the electrical charge on each ion; and 2) the relative sizes of the cations and anions.

12.2 In this problem we are asked to show that the minimum cation-to-anion radius ratio for a coordination number of four is 0.225. If lines are drawn from the centers of the anions, then a tetrahedron is formed. The tetrahedron may be inscribed within a cube as shown below.

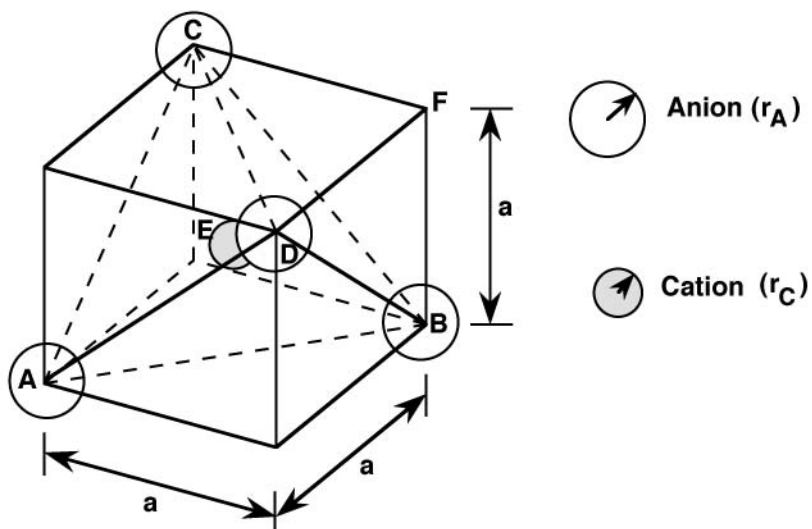

The spheres at the apexes of the tetrahedron are drawn at the corners of the cube, and designated as positions **A**, **B**, **C**, and **D**. (These are reduced in size for the sake of clarity.) The cation resides at the center of the cube, which is designated as point **E**. Let us now express the cation and anion radii in terms of the cube edge length, designated as **a**. The spheres located at positions **A** and **B** touch each other along the bottom face diagonal. Thus,

$$\overline{AB} = 2r_A$$

But

$$(\overline{AB})^2 = a^2 + a^2 = 2a^2$$

or

$$\overline{AB} = a\sqrt{2} = 2r_A$$

And

$$a = \frac{2r_A}{\sqrt{2}}$$

There will also be an anion located at the corner, point **F** (not drawn), and the cube diagonal **AEF** will be related to the ionic radii as

$$\overline{AEF} = 2(r_A + r_C)$$

(The line **AEF** has not been drawn to avoid confusion.) From the triangle **ABF**

$$(\overline{AB})^2 + (\overline{FB})^2 = (\overline{AEF})^2$$

But,

$$\overline{FB} = a = \frac{2r_A}{\sqrt{2}}$$

and

$$\overline{AB} = 2r_A$$

from above. Thus,

$$(2r_A)^2 + \left(\frac{2r_A}{\sqrt{2}}\right)^2 = [2(r_A + r_C)]^2$$

Solving for the  $r_C/r_A$  ratio leads to

$$\frac{r_C}{r_A} = \frac{\sqrt{6} - 2}{2} = 0.225$$

12.3 This problem asks us to show, using the rock salt crystal structure, that the minimum cation-to-anion radius ratio is 0.414 for a coordination number of six. Below is shown one of the faces of the rock salt crystal structure in which anions and cations just touch along the edges, and also the face diagonals.

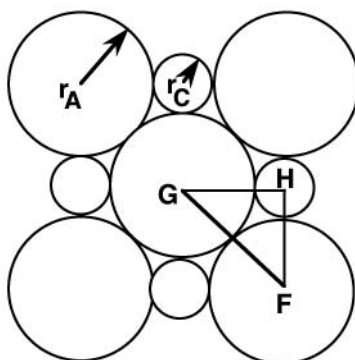

From triangle **FGH**,

$$\overline{GF} = 2r_A \text{ and } \overline{FH} = \overline{GH} = r_A + r_C$$

Since **FGH** is a right triangle

$$(\overline{GH})^2 + (\overline{FH})^2 = (\overline{FG})^2$$

or

$$(r_A + r_C)^2 + (r_A + r_C)^2 = (2r_A)^2$$

which leads to

$$r_A + r_C = \frac{2r_A}{\sqrt{2}}$$

Or, solving for  $r_C/r_A$

$$\frac{r_C}{r_A} = \left( \frac{2}{\sqrt{2}} - 1 \right) = 0.414$$

12.4 This problem asks us to show that the minimum cation-to-anion radius ratio for a coordination number of 8 is 0.732. From the cubic unit cell shown below

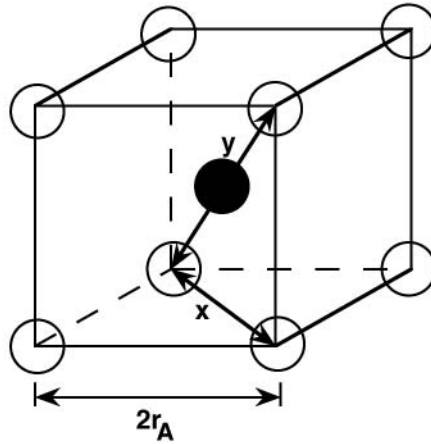

the unit cell edge length is  $2r_A$ , and from the base of the unit cell

$$x^2 = (2r_A)^2 + (2r_A)^2 = 8r_A^2$$

Or

$$x = 2r_A\sqrt{2}$$

Now from the triangle that involves  $x$ ,  $y$ , and the unit cell edge

$$x^2 + (2r_A)^2 = y^2 = (2r_A + 2r_C)^2$$

$$(2r_A\sqrt{2})^2 + 4r_A^2 = (2r_A + 2r_C)^2$$

Which reduces to

$$2r_A(\sqrt{3} - 1) = 2r_C$$

Or

$$\frac{r_C}{r_A} = \sqrt{3} - 1 = 0.732$$

12.5 This problem calls for us to predict crystal structures for several ceramic materials on the basis of ionic charge and ionic radii.

(a) For CsI, from Table 12.3

$$\frac{r_{\text{Cs}^+}}{r_{\text{I}^-}} = \frac{0.170 \text{ nm}}{0.220 \text{ nm}} = 0.773$$

Now, from Table 12.2, the coordination number for each cation ( $\text{Cs}^+$ ) is eight, and, using Table 12.4, the predicted crystal structure is cesium chloride.

(b) For NiO, from Table 12.3

$$\frac{r_{\text{Ni}^{2+}}}{r_{\text{O}^{2-}}} = \frac{0.069 \text{ nm}}{0.140 \text{ nm}} = 0.493$$

The coordination number is six (Table 12.2), and the predicted crystal structure is sodium chloride (Table 12.4).

(c) For KI, from Table 12.3

$$\frac{r_{\text{K}^+}}{r_{\text{I}^-}} = \frac{0.138 \text{ nm}}{0.220 \text{ nm}} = 0.627$$

The coordination number is six (Table 12.2), and the predicted crystal structure is sodium chloride (Table 12.4).

(d) For NiS, from Table 12.3

$$\frac{r_{\text{Ni}^{2+}}}{r_{\text{S}^{2-}}} = \frac{0.069 \text{ nm}}{0.184 \text{ nm}} = 0.375$$

The coordination number is four (Table 12.2), and the predicted crystal structure is zinc blende (Table 12.4).

12.6 We are asked to cite the cations in Table 12.3 which would form fluorides having the cesium chloride crystal structure. First of all, the possibilities would include only the monovalent cations  $\text{Cs}^+$ ,  $\text{K}^+$ , and  $\text{Na}^+$ . Furthermore, the coordination number for each cation must be 8, which means that  $0.732 < r_{\text{C}}/r_{\text{A}} < 1.0$  (Table 12.2). From Table 12.3 the  $r_{\text{C}}/r_{\text{A}}$  ratios for these three cations are as follows:

$$\frac{r_{\text{Cs}^+}}{r_{\text{F}^-}} = \frac{0.170 \text{ nm}}{0.133 \text{ nm}} = 1.28$$

$$\frac{r_{\text{K}^+}}{r_{\text{F}^-}} = \frac{0.138 \text{ nm}}{0.133 \text{ nm}} = 1.04$$

$$\frac{r_{\text{Na}^+}}{r_{\text{F}^-}} = \frac{0.102 \text{ nm}}{0.133 \text{ nm}} = 0.77$$

Thus, only sodium will form the CsCl crystal structure with fluorine.

12.7 This problem asks that we compute the atomic packing factor for the rock salt crystal structure when  $r_{\text{C}}/r_{\text{A}} = 0.414$ . From Equation (3.2)

$$\text{APF} = \frac{V_{\text{S}}}{V_{\text{C}}}$$

With regard to the sphere volume,  $V_{\text{S}}$ , there are four cation and four anion spheres per unit cell.

Thus,

$$V_{\text{S}} = (4)\left(\frac{4}{3}\pi r_{\text{A}}^3\right) + (4)\left(\frac{4}{3}\pi r_{\text{C}}^3\right)$$

But, since  $r_{\text{C}}/r_{\text{A}} = 0.414$

$$V_{\text{S}} = \frac{16}{3}\pi r_{\text{A}}^3 \left[1 + (0.414)^3\right] = (17.94)r_{\text{A}}^3$$

Now, for  $r_{\text{C}}/r_{\text{A}} = 0.414$  the corner anions in Table 12.2 just touch one another along the cubic unit cell edges such that

$$\begin{aligned} V_{\text{C}} &= a^3 = \left[2(r_{\text{A}} + r_{\text{C}})\right]^3 \\ &= \left[2(r_{\text{A}} + 0.414r_{\text{A}})\right]^3 = (22.62)r_{\text{A}}^3 \end{aligned}$$

Thus

$$\text{APF} = \frac{V_{\text{S}}}{V_{\text{C}}} = \frac{(17.94)r_{\text{A}}^3}{(22.62)r_{\text{A}}^3} = 0.79$$



12.8 We are asked to describe the crystal structure for  $K_2O$ , and then explain why it is called the antifluorite structure. First, let us find the coordination number of each  $O^{2-}$  ion for  $K_2O$ . Taking the cation-anion radii ratio

$$\frac{r_{K^+}}{r_{O^{2-}}} = \frac{0.138 \text{ nm}}{0.140 \text{ nm}} = 0.985$$

From Table 12.2, the coordination number for oxygen is eight. According to Table 12.4, for a coordination number of eight for both cations and anions, the crystal structure should be cesium chloride. However, there are twice as many  $K^+$  as  $O^{2-}$  ions. Therefore, the centers of the  $K^+$  ions are positioned at the corners of cubic unit cells, while half of the cube centers are occupied by  $O^{2-}$  ions.

This structure is called the antifluorite crystal structure because anions and cations are interchanged with one another from the fluorite structure (Figure 12.5).

12.9 This question is concerned with the zinc blende crystal structure in terms of close-packed planes of anions.

(a) The stacking sequence of close-packed planes of anions for the zinc blende crystal structure will be the same as FCC (and not HCP) because the anion packing is FCC (Table 12.4).

(b) The cations will fill tetrahedral positions since the coordination number for cations is four (Table 12.4).

(c) Only one-half of the tetrahedral positions will be occupied because there are two tetrahedral sites per anion, and yet only one cation per anion.

12.10 This question is concerned with the corundum crystal structure in terms of close-packed planes of anions.

(a) For this crystal structure, two-thirds of the octahedral positions will be filled with  $Al^{3+}$  ions since there is one octahedral site per  $O^{2-}$  ion, and the ratio of  $Al^{3+}$  to  $O^{2-}$  ions is two-to-three.

(b) Two close-packed  $O^{2-}$  planes and the octahedral positions that will be filled with  $Al^{3+}$  ions are sketched below.

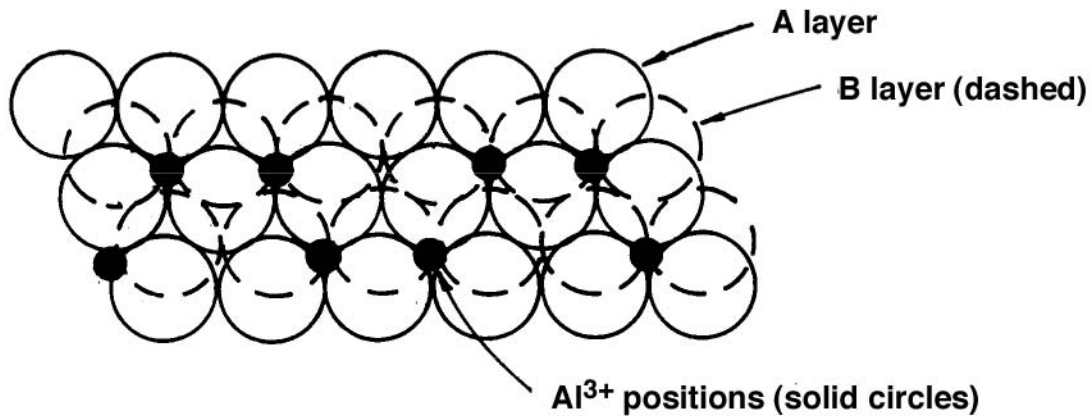

12.11 (a) This portion of the problem asks that we specify which type of interstitial site the Be<sup>2+</sup> ions will occupy in BeO if the ionic radius of Be<sup>2+</sup> is 0.035 nm and the O<sup>2-</sup> ions form an HCP arrangement. Since, from Table 12.4,  $r_{O^{2-}} = 0.140$  nm, then

$$\frac{r_{Be^{2+}}}{r_{O^{2-}}} = \frac{0.035 \text{ nm}}{0.140 \text{ nm}} = 0.250$$

Inasmuch as  $r_C/r_A$  is between 0.225 and 0.414, the coordination number for Be<sup>2+</sup> is 4 (Table 12.2); therefore, tetrahedral interstitial positions are occupied.

(b) We are now asked what fraction of these available interstitial sites are occupied by Be<sup>2+</sup> ions. Since there are two tetrahedral sites per O<sup>2-</sup> ion, and the ratio of Be<sup>2+</sup> to O<sup>2-</sup> is 1:1, one-half of these sites are occupied with Be<sup>2+</sup> ions.

12.12 (a) We are first of all asked to cite, for FeTiO<sub>3</sub>, which type of interstitial site the Fe<sup>2+</sup> ions will occupy. From Table 12.3, the cation-anion radius ratio is

$$\frac{r_{Fe^{2+}}}{r_{O^{2-}}} = \frac{0.077 \text{ nm}}{0.140 \text{ nm}} = 0.550$$

Since this ratio is between 0.414 and 0.732, the Fe<sup>2+</sup> ions will occupy octahedral sites (Table 12.2).

(b) Similarly, for the Ti<sup>4+</sup> ions

$$\frac{r_{\text{Ti}^{4+}}}{r_{\text{O}^{2-}}} = \frac{0.061 \text{ nm}}{0.140 \text{ nm}} = 0.436$$

Since this ratio is between 0.414 and 0.732, the  $\text{Ti}^{4+}$  ions will also occupy octahedral sites.

(c) Since both  $\text{Fe}^{2+}$  and  $\text{Ti}^{4+}$  ions occupy octahedral sites, no tetrahedral sites will be occupied.

(d) For every  $\text{FeTiO}_3$  formula unit, there are three  $\text{O}^{2-}$  ions, and, therefore, three octahedral sites; since there is one ion each of  $\text{Fe}^{2+}$  and  $\text{Ti}^{4+}$ , two-thirds of these octahedral sites will be occupied.

12.13 First of all, open 'Notepad' in Windows. Now enter into "Notepad" commands to generate the PbO unit cell. One set of commands that may be used is as follows:

```
[DisplayProps]
Rotatex=-30
Rotatey=-15

[AtomProps]
Oxygen=LtRed,0.14
Lead=LtCyan,0.10

[BondProps]
SingleSolid=LtGray

[Atoms]
O1=0,0,0,Oxygen
O2=1,0,0,Oxygen
O3=1,1,0,Oxygen
O4=0,1,0,Oxygen
O5=0,0,1.265,Oxygen
O6=1,0,1.265,Oxygen
O7=1,1,1.265,Oxygen
O8=0,1,1.265,Oxygen
O9=0.5,0.5,0,Oxygen
O10=0.5,0.5,1.265,Oxygen
Pb1=0,0.5,0.3,Lead
Pb2=1,0.5,0.3,Lead
Pb3=0.5,0,0.965,Lead
Pb4=0.5,1,0.965,Lead

[Bonds]
B1=O1,O2,SingleSolid
B2=O2,O3,SingleSolid
B3=O3,O4,SingleSolid
B4=O1,O4,SingleSolid
B5=O5,O6,SingleSolid
B6=O6,O7,SingleSolid
B7=O7,O8,SingleSolid
B8=O5,O8,SingleSolid
B9=O1,O5,SingleSolid
B10=O2,O6,SingleSolid
```

B11=O3,O7,SingleSolid  
B12=O4,O8,SingleSolid

Under the "File" menu of "Note Pad," click "Save As", and then assign the file for this figure a name followed by a period and "mdf"; for example, "PbO.mdf". And, finally save this file in the "mdf" file inside of the "Interactive MSE" folder (which may be found in its installed location).

Now, in order to view the unit cell just generated, bring up "Interactive MSE", and then open any one of the three submodules under "Crystallinity and Unit Cells" or the "Ceramic Structures" module. Next select "Open" under the "File" menu, and then open the "mdf" folder. Finally, select the name you assigned to the item in the window that appears, and hit the "OK" button. The image that you generated will now be displayed.

12.14 We are asked to calculate the theoretical density of NiO. This density may be computed using Equation (12.1) as

$$\rho = \frac{n'(A_{\text{Ni}} + A_{\text{O}})}{V_{\text{C}}N_{\text{A}}}$$

Since the crystal structure is rock salt,  $n' = 4$  formula units per unit cell, and

$$\begin{aligned} V_{\text{C}} = a^3 &= \left( 2r_{\text{Ni}^{2+}} + 2r_{\text{O}^{2-}} \right)^3 = [2(0.069 \text{ nm}) + 2(0.140 \text{ nm})]^3 \\ &= 0.0730 \frac{\text{nm}^3}{\text{unit cell}} = 7.30 \times 10^{-23} \frac{\text{cm}^3}{\text{unit cell}} \end{aligned}$$

Thus,

$$\begin{aligned} \rho &= \frac{(4 \text{ formula units/unit cell})(58.69 \text{ g/mol} + 16.00 \text{ g/mol})}{\left( 7.30 \times 10^{-23} \text{ cm}^3/\text{unit cell} \right) \left( 6.023 \times 10^{23} \text{ formula units/mol} \right)} \\ &= 6.79 \text{ g/cm}^3 \end{aligned}$$

12.15 This problem calls for us to determine the unit cell edge length for MgO. The density of MgO is  $3.58 \text{ g/cm}^3$  and the crystal structure is rock salt.

(a) From Equation (12.1)

$$\rho = \frac{n'(A_{\text{Mg}} + A_{\text{O}})}{V_{\text{C}} N_{\text{A}}} = \frac{n'(A_{\text{Mg}} + A_{\text{O}})}{a^3 N_{\text{A}}}$$

Or,

$$a = \left[ \frac{n'(A_{\text{Mg}} + A_{\text{O}})}{\rho N_{\text{A}}} \right]^{1/3}$$

$$= \left[ \frac{(4 \text{ formula units/unit cell})(24.31 \text{ g/mol} + 16.00 \text{ g/mol})}{(3.58 \text{ g/cm}^3)(6.023 \times 10^{23} \text{ formula units/mol})} \right]^{1/3}$$

$$= 4.21 \times 10^{-8} \text{ cm} = 0.421 \text{ nm}$$

(b) The edge length is to be determined from the  $\text{Mg}^{2+}$  and  $\text{O}^{2-}$  radii for this portion of the problem.  
Now

$$a = 2r_{\text{Mg}^{2+}} + 2r_{\text{O}^{2-}}$$

From Table 12.3

$$a = 2(0.072 \text{ nm}) + 2(0.140 \text{ nm}) = 0.424 \text{ nm}$$

12.16 This problem asks that we compute the theoretical density of diamond given that the C—C distance and bond angle are 0.154 nm and 109.5°, respectively. The first thing we need do is to determine the unit cell edge length from the given C—C distance. The drawing below shows the cubic unit cell with those carbon atoms that bond to one another in one-quarter of the unit cell.

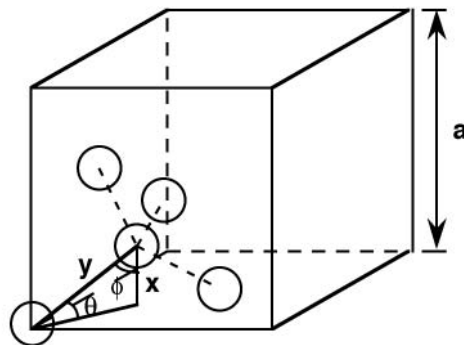

From this figure,  $\phi$  is one-half of the bond angle or  $\phi = 109.5^\circ/2 = 54.75^\circ$ , which means that

$$\theta = 90^\circ - 54.75^\circ = 35.25^\circ$$

since the triangle shown is a right triangle. Also,  $y = 0.154$  nm, the carbon-carbon bond distance.

Furthermore,  $x = a/4$ , and therefore,

$$x = \frac{a}{4} = y \sin \theta$$

Or

$$a = 4y \sin \theta = (4)(0.154 \text{ nm})(\sin 35.25^\circ) = 0.356 \text{ nm}$$

$$= 3.56 \times 10^{-8} \text{ cm}$$

The unit cell volume,  $V_C$ , is just  $a^3$ , that is

$$V_C = a^3 = (3.56 \times 10^{-8} \text{ cm})^3 = 4.51 \times 10^{-23} \text{ cm}^3$$

We must now utilize a modified Equation (12.1) since there is only one atom type. There are 8 equivalent atoms per unit cell, and therefore

$$\begin{aligned} \rho &= \frac{n' A_C}{V_C N_A} \\ &= \frac{(8 \text{ atoms/unit cell})(12.01 \text{ g/mol})}{(4.51 \times 10^{-23} \text{ cm}^3/\text{unit cell})(6.023 \times 10^{23} \text{ atoms/mol})} \\ &= 3.54 \text{ g/cm}^3 \end{aligned}$$

The measured density is  $3.51 \text{ g/cm}^3$ .

12.17 This problem asks that we compute the theoretical density of ZnS given that the Zn—S distance and bond angle are 0.234 nm and  $109.5^\circ$ , respectively. The first thing we need do is to determine the unit cell volume from the given Zn—S distance. From the previous problem, the unit cell volume  $V_C$  is just  $a^3$ ,  $a$  being the unit cell edge length, and

$$V_C = [4y \sin \theta]^3 = [(4)(0.234 \text{ nm})(\sin 35.25^\circ)]^3$$

$$= 0.1576 \text{ nm}^3 = 1.576 \times 10^{-22} \text{ cm}^3$$

Now we must utilize Equation (12.1) with  $n' = 4$  formula units, and  $A_{\text{Zn}}$  and  $A_{\text{S}}$  being 65.39 and 32.06 g/mol, respectively. Thus

$$\rho = \frac{n'(A_{\text{Zn}} + A_{\text{S}})}{V_C N_A}$$

$$= \frac{(4 \text{ formula units/unit cell})(65.39 \text{ g/mol} + 32.06 \text{ g/mol})}{(1.576 \times 10^{-22} \text{ cm}^3/\text{unit cell})(6.023 \times 10^{23} \text{ formula units/mol})}$$

$$= 4.11 \text{ g/cm}^3$$

The measured value of the density is  $4.10 \text{ g/cm}^3$ .

12.18 We are asked to determine the number of  $\text{Cd}^{2+}$  and  $\text{S}^{2-}$  ions per unit cell for cadmium sulfide (CdS). For CdS,  $a = 0.582 \text{ nm}$  and  $\rho = 4.82 \text{ g/cm}^3$ . Using Equation (12.1)

$$n' = \frac{\rho V_C N_A}{A_{\text{Cd}} + A_{\text{S}}} = \frac{\rho a^3 N_A}{A_{\text{Cd}} + A_{\text{S}}}$$

$$= \frac{(4.82 \text{ g/cm}^3)(5.82 \times 10^{-8} \text{ cm})^3 (6.023 \times 10^{23} \text{ formula units/mol})}{(112.40 \text{ g/mol} + 32.06 \text{ g/mol})}$$

$$= 3.96 \text{ or almost } 4$$

Therefore, there are four  $\text{Cd}^{2+}$  and four  $\text{S}^{2-}$  per unit cell.

12.19 (a) We are asked to compute the theoretical density of CsCl. Modifying the result of Problem 3.4, we get

$$a = \frac{2r_{\text{Cs}^+} + 2r_{\text{Cl}^-}}{\sqrt{3}} = \frac{2(0.170 \text{ nm}) + 2(0.181 \text{ nm})}{\sqrt{3}}$$

$$= 0.405 \text{ nm} = 4.05 \times 10^{-8} \text{ cm}$$

From Equation (12.1)

$$\rho = \frac{n'(A_{\text{Cs}} + A_{\text{Cl}})}{V_{\text{C}}N_{\text{A}}} = \frac{n'(A_{\text{Cs}} + A_{\text{Cl}})}{a^3N_{\text{A}}}$$

For the CsCl crystal structure,  $n' = 1$  formula unit/unit cell, and thus

$$\rho = \frac{(1 \text{ formula unit/unit cell})(132.91 \text{ g/mol} + 35.45 \text{ g/mol})}{\left[ (4.05 \times 10^{-8} \text{ cm})^3 / \text{unit cell} \right] (6.023 \times 10^{23} \text{ formula units/mol})}$$

$$= 4.20 \text{ g/cm}^3$$

(b) This value of the theoretical density is greater than the measured density. The reason for this discrepancy is that the ionic radii in Table 12.3, used for this computation, were for a coordination number of six, when, in fact, the coordination number of both  $\text{Cs}^+$  and  $\text{Cl}^-$  is eight. The ionic radii should be slightly greater, leading to a larger  $V_{\text{C}}$  value, and a lower theoretical density.

12.20 This problem asks that we compute the theoretical density of  $\text{CaF}_2$ . A unit cell of the fluorite structure is shown in Figure 12.5. It may be seen that there are four  $\text{CaF}_2$  units per unit cell (i.e.,  $n' = 4$  formula units/unit cell). Using a modified form of the result of Problem 3.4, we may assume, for each of the eight small cubes in the unit cell, that

$$a = \frac{2r_{\text{Ca}^{2+}} + 2r_{\text{F}^-}}{\sqrt{3}}$$

and, from Table 12.3

$$a = \frac{2(0.100 \text{ nm}) + 2(0.133 \text{ nm})}{\sqrt{3}} = 0.269 \text{ nm} = 2.69 \times 10^{-8} \text{ cm}$$

The volume of the unit cell is just



$$V_C = (2a)^3 = \left[ (2)(2.69 \times 10^{-3} \text{ cm}) \right]^3 = 1.56 \times 10^{-22} \text{ cm}^3$$

Thus, from Equation (12.1)

$$\begin{aligned} \rho &= \frac{n'(A_{Ca} + 2A_F)}{V_C N_A} \\ &= \frac{(4 \text{ formula units/unit cell}) [40.08 \text{ g/mol} + (2)(19.00 \text{ g/mol})]}{(1.56 \times 10^{-22} \text{ cm}^3/\text{unit cell}) (6.023 \times 10^{23} \text{ formula units/mol})} \\ &= 3.33 \text{ g/cm}^3 \end{aligned}$$

The measured density is  $3.18 \text{ g/cm}^3$ .

12.21 We are asked to specify possible crystal structures for an AX type of ceramic material given its density ( $2.10 \text{ g/cm}^3$ ), that the unit cell has cubic symmetry with edge length of  $0.57 \text{ nm}$ , and the atomic weights of the A and X elements ( $28.5$  and  $30.0 \text{ g/mol}$ , respectively). Using Equation (12.1) and solving for  $n'$  yields

$$\begin{aligned} n' &= \frac{\rho V_C N_A}{\sum A_C + \sum A_A} \\ &= \frac{(2.10 \text{ g/cm}^3) \left[ (5.70 \times 10^{-8} \text{ cm})^3 / \text{unit cell} \right] (6.023 \times 10^{23} \text{ formula units/mol})}{(30.0 + 28.5) \text{ g/mol}} \\ &= 4.00 \text{ formula units/unit cell} \end{aligned}$$

Of the three possible crystal structures, only sodium chloride and zinc blende have four formula units per unit cell, and therefore, are possibilities.

12.22 This problem asks us to compute the atomic packing factor for  $\text{Fe}_3\text{O}_4$  given its density and unit cell edge length. It is first necessary to determine the number of formula units in the unit cell in order to calculate the sphere volume. Solving for  $n'$  from Equation (12.1) leads to

$$n' = \frac{\rho V_C N_A}{\sum A_C + \sum A_A}$$

$$= \frac{(5.24 \text{ g/cm}^3) \left[ (8.39 \times 10^{-8} \text{ cm})^3 / \text{unit cell} \right] (6.023 \times 10^{23} \text{ formula units/mol})}{(3)(55.85 \text{ g/mol}) + (4)(16.00 \text{ g/mol})}$$

$$= 8.0 \text{ formula units/unit cell}$$

Thus, in each unit cell there are 8  $\text{Fe}^{2+}$ , 16  $\text{Fe}^{3+}$ , and 32  $\text{O}^{2-}$  ions. From Table 12.3,  $r_{\text{Fe}^{2+}} = 0.077$  nm,  $r_{\text{Fe}^{3+}} = 0.069$  nm, and  $r_{\text{O}^{2-}} = 0.140$  nm. Thus, the total sphere volume,  $V_S$  in Equation (3.2), is just

$$V_S = (8) \left( \frac{4}{3} \pi \right) (7.7 \times 10^{-9} \text{ cm})^3 + (16) \left( \frac{4}{3} \pi \right) (6.9 \times 10^{-9} \text{ cm})^3$$

$$+ (32) \left( \frac{4}{3} \pi \right) (1.40 \times 10^{-8} \text{ cm})^3$$

$$= 4.05 \times 10^{-22} \text{ cm}^3$$

Now, the unit cell volume ( $V_C$ ) is just

$$V_C = a^3 = (8.39 \times 10^{-8} \text{ cm})^3 = 5.90 \times 10^{-22} \text{ cm}^3$$

Finally, the atomic packing factor (**APF**) from Equation (3.2) is just

$$\text{APF} = \frac{V_S}{V_C} = \frac{4.05 \times 10^{-22} \text{ cm}^3}{5.90 \times 10^{-22} \text{ cm}^3} = 0.686$$

12.23 This problem asks for us to calculate the atomic packing factor for aluminum oxide given values for the **a** and **c** lattice parameters, and the density. It first becomes necessary to determine the value of  $n'$  in Equation (12.1). This necessitates that we calculate the value of  $V_C$ , the unit cell volume. In Problem 3.7 it was shown that the area of the hexagonal base (**AREA**) is related to **a** as

$$\begin{aligned} \text{AREA} &= 6\sqrt{3}\left(\frac{a}{2}\right)^2 = 1.5a^2\sqrt{3} \\ &= (1.5)\left(4.759 \times 10^{-8} \text{ cm}\right)^2 (1.732) = 5.88 \times 10^{-15} \text{ cm}^2 \end{aligned}$$

The unit cell volume now is just

$$\begin{aligned} V_C &= (\text{AREA})(c) = (5.88 \times 10^{-15} \text{ cm}^2)(1.2989 \times 10^{-7} \text{ cm}) \\ &= 7.64 \times 10^{-22} \text{ cm}^3 \end{aligned}$$

Now, solving for  $n'$  in Equation (12.1) yields

$$\begin{aligned} n' &= \frac{\rho N_A V_C}{\sum A_C + \sum A_A} \\ &= \frac{(3.99 \text{ g/cm}^3)(6.023 \times 10^{23} \text{ formula units/mol})(7.64 \times 10^{-22} \text{ cm}^3/\text{unit cell})}{(2)(26.98 \text{ g/mol}) + (3)(16.00 \text{ g/mol})} \\ &= 18.0 \text{ formula units/unit cell} \end{aligned}$$

Thus, there are 18  $\text{Al}_2\text{O}_3$  units per unit cell, or 36  $\text{Al}^{3+}$  ions and 54  $\text{O}^{2-}$  ions. From Table 12.3, the radii of these two ion types are 0.053 and 0.140 nm, respectively. Thus, the total sphere volume,  $V_S$  in Equation (3.2), is just

$$\begin{aligned} V_S &= (36)\left(\frac{4}{3}\pi\right)\left(5.3 \times 10^{-9} \text{ cm}\right)^3 + (54)\left(\frac{4}{3}\pi\right)\left(1.4 \times 10^{-8} \text{ cm}\right)^3 \\ &= 6.43 \times 10^{-22} \text{ cm}^3 \end{aligned}$$

Finally, the **APF** is just

$$\text{APF} = \frac{V_S}{V_C} = \frac{6.43 \times 10^{-22} \text{ cm}^3}{7.64 \times 10^{-22} \text{ cm}^3} = 0.842$$

12.24 We are asked in this problem to compute the atomic packing factor for the diamond cubic crystal structure, given that the angle between adjacent bonds is  $109.5^\circ$ . The first thing that we must do is to determine the unit cell volume  $V_C$  in terms of the atomic radius  $r$ . From Problem 12.16 the following relationship was developed

$$a = 4y \sin \theta$$

in which  $y = 2r$  and  $\theta = 35.25^\circ$ . Furthermore, since the unit cell is cubic,  $V_C = a^3$ ; therefore

$$V_C = (4y \sin \theta)^3 = [(4)(2r)(\sin 35.25^\circ)]^3 = 98.43 r^3$$

Now, it is necessary to determine the sphere volume in the unit cell,  $V_S$ , in terms of  $r$ . For this unit cell (Figure 12.15) there are 4 interior atoms, 6 face atoms, and 8 corner atoms. The entirety of each of the interior atoms, one-half of each face atom, and one-eighth of each corner atom belong to the unit cell. Therefore, there are 8 equivalent atoms per unit cell; hence

$$V_S = (8) \left( \frac{4}{3} \pi r^3 \right) = 33.51 r^3$$

Finally, the atomic packing factor is just

$$\text{APF} = \frac{V_S}{V_C} = \frac{33.51 r^3}{98.43 r^3} = 0.340$$

12.25 We are asked in this problem to compute the atomic packing factor for the CsCl crystal structure. This requires that we take the ratio of the sphere volume within the unit cell and the total unit cell volume. From Figure 12.3 there is the equivalent of one Cs and one Cl ion per unit cell; the ionic radii of these two ions are 0.170 nm and 0.181 nm, respectively (Table 12.3). Thus, the sphere volume,  $V_S$ , is just

$$V_S = \frac{4}{3} (\pi) \left[ (0.170 \text{ nm})^3 + (0.181 \text{ nm})^3 \right] = 0.0454 \text{ nm}^3$$

Using a modified form of the result of Problem 3.4, for CsCl we may express the unit cell edge length,  $a$ , in terms of the atomic radii as

$$a = \frac{2r_{\text{Cs}^+} + 2r_{\text{Cl}^-}}{\sqrt{3}} = \frac{2(0.170 \text{ nm}) + 2(0.181 \text{ nm})}{\sqrt{3}}$$

$$= 0.405 \text{ nm}$$

Since  $V_C = a^3$

$$V_C = (0.405 \text{ nm})^3 = 0.0664 \text{ nm}^3$$

And, finally the atomic packing factor is just

$$\text{APF} = \frac{V_S}{V_C} = \frac{0.0454 \text{ nm}^3}{0.0664 \text{ nm}^3} = 0.684$$

12.26 This problem asks that we represent specific crystallographic planes for various ceramic crystal structures.

(a) A portion of the (100) plane for the rock salt crystal structure would appear as

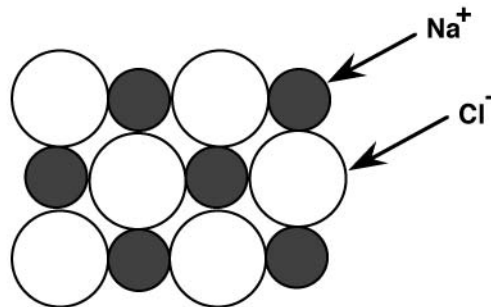

(b) A portion of the (110) plane for the cesium chloride crystal structure would appear as

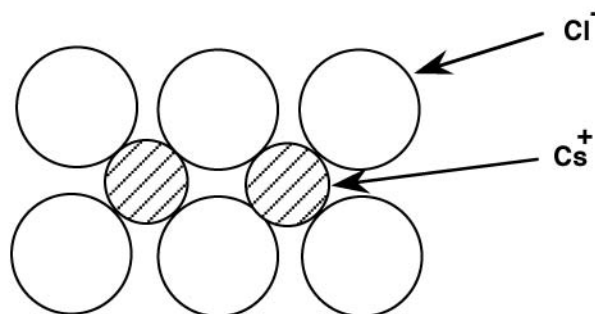

(c) A portion of the (111) plane for the zinc blende crystal structure would appear as

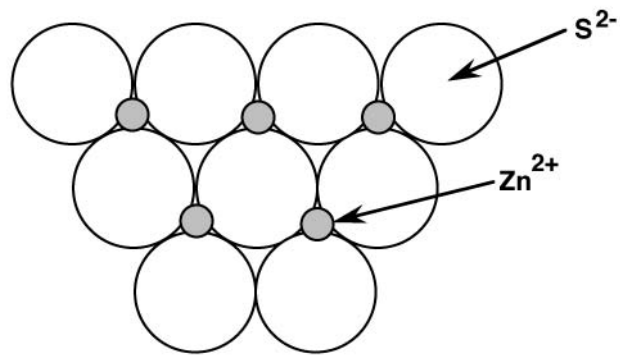

(d) A portion of the (110) plane for the perovskite crystal structure would appear as

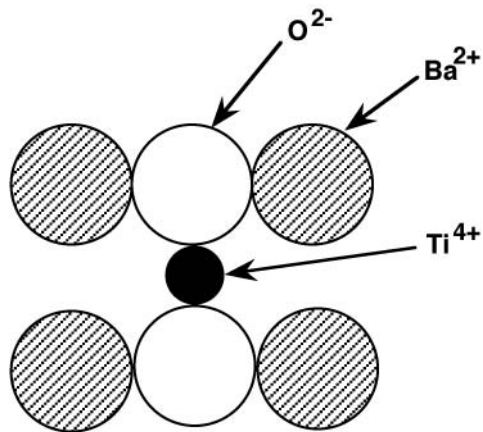

12.27 The silicate materials have relatively low densities because the atomic bonds are primarily covalent in nature (Table 12.1), and, therefore, directional. This limits the packing efficiency of the atoms, and therefore, the magnitude of the density.

12.28 This problem asks for us to determine the angle between covalent bonds in an  $\text{SiO}_4^{4-}$  tetrahedron.

Below is shown one such tetrahedron situated within a cube.

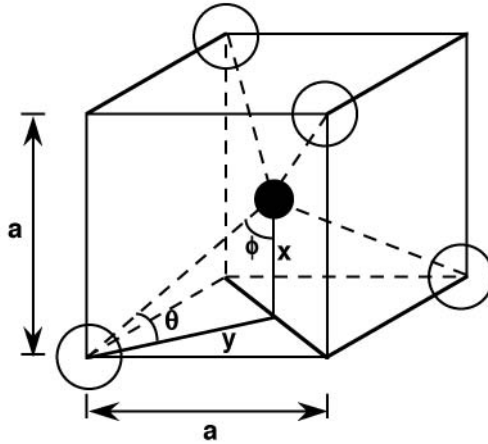

Now if we extend the base diagonal from one corner to the other, it is the case that

$$(2y)^2 = a^2 + a^2 = 2a^2$$

or

$$y = \frac{a\sqrt{2}}{2}$$

Furthermore,  $x = a/2$ , and

$$\tan \theta = \frac{x}{y} = \frac{\frac{a}{2}}{\frac{a\sqrt{2}}{2}} = \frac{1}{\sqrt{2}}$$

From which

$$\theta = \tan^{-1}\left(\frac{1}{\sqrt{2}}\right) = 35.26^\circ$$

Now, solving for the angle  $\phi$

$$\phi = 180^\circ - 90^\circ - 35.26^\circ = 54.74^\circ$$

Finally, the bond angle is just  $2\phi$ , or  $2\phi = (2)(54.74^\circ) = 109.48^\circ$ .

12.29 (a) The chemical formula for kaolinite clay may also be written as  $\text{Al}_2\text{O}_3 \cdot 2\text{SiO}_2 \cdot 2\text{H}_2\text{O}$ . Thus, if we remove the chemical water, the formula becomes  $\text{Al}_2\text{O}_3 \cdot 2\text{SiO}_2$ . The formula weight for  $\text{Al}_2\text{O}_3$  is just  $(2)(26.98 \text{ g/mol}) + (3)(16.00 \text{ g/mole}) = 101.96 \text{ g/mol}$ ; and for  $\text{SiO}_2$  the formula weight is  $28.09 \text{ g/mol} + (2)(16.00 \text{ g/mol}) = 60.09 \text{ g/mol}$ . Thus, the composition of this product, in terms of the concentration of  $\text{Al}_2\text{O}_3$ ,  $C_{\text{Al}_2\text{O}_3}$ , in weight percent is just

$$C_{\text{Al}_2\text{O}_3} = \frac{101.96 \text{ g/mol}}{101.96 \text{ g/mol} + (2)(60.09 \text{ g/mol})} \times 100 = 45.9 \text{ wt\%}$$

(b) The liquidus and solidus temperatures for this material as determined from the  $\text{SiO}_2\text{-Al}_2\text{O}_3$  phase diagram, Figure 12.27, are  $1800^\circ\text{C}$  and  $1587^\circ\text{C}$ , respectively.

12.30 Frenkel defects for anions would not exist in appreciable concentrations because the anion is quite large and is highly unlikely to exist as an interstitial.

12.31 Stoichiometric means having the exact ratio of anions to cations as specified by the chemical formula for the compound.

12.32 (a) For a  $\text{Cu}^{2+}\text{O}^{2-}$  compound in which a small fraction of the  $\text{Cu}^{2+}$  ions exist as  $\text{Cu}^+$ , for each  $\text{Cu}^+$  formed there is one less positive charge introduced (or one more negative charge). In order to maintain charge neutrality, we must either add an additional positive charge or remove a negative charge. This may be accomplished by either creating  $\text{Cu}^{2+}$  interstitials or  $\text{O}^{2-}$  vacancies.

(b) There will be two  $\text{Cu}^+$  ions required for each of these defects.

(c) The chemical formula for this nonstoichiometric material may be expressed as  $\text{Cu}_{1+x}\text{O}$  or  $\text{CuO}_{1-x}$ , where  $x$  is some small fraction.

12.33 (a) For  $\text{Li}^+$  substituting for  $\text{Ca}^{2+}$  in  $\text{CaO}$ , oxygen vacancies would be created. For each  $\text{Li}^+$  substituting for  $\text{Ca}^{2+}$ , one positive charge is removed; in order to maintain charge neutrality, a single negative charge may be removed. Negative charges are eliminated by creating oxygen vacancies, and for every two  $\text{Li}^+$  ions added, a single oxygen vacancy is formed.

(b) For  $\text{Cl}^-$  substituting for  $\text{O}^{2-}$  in  $\text{CaO}$ , calcium vacancies would be created. For each  $\text{Cl}^-$  substituting for an  $\text{O}^{2-}$ , one negative charge is removed; in order to maintain charge neutrality, two  $\text{Cl}^-$  ions will lead to the formation of one calcium vacancy.

12.34 For every  $\text{Mg}^{2+}$  ion that substitutes for  $\text{Al}^{3+}$  in  $\text{Al}_2\text{O}_3$ , a single positive charge is removed. Thus, in order to maintain charge neutrality, either a positive charge must be added or a negative charge must be removed.

Positive charges are added by forming  $\text{Al}^{3+}$  interstitials, and one  $\text{Al}^{3+}$  interstitial would be formed for every three  $\text{Mg}^{2+}$  ions added.



Negative charges may be removed by forming  $O^{2-}$  vacancies, and one oxygen vacancy would be formed for every two  $Mg^{2+}$  ions added.

12.35 There is only one eutectic for the portion of the  $ZrO_2$ -CaO system shown in Figure 12.26, which, upon cooling, is



There are two eutectoids, which reactions are as follows:

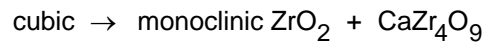
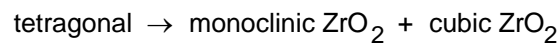

12.36 (a) For this portion of the problem we are to determine the type of vacancy defect that is produced on the  $Al_2O_3$ -rich side of the spinel phase field (Figure 12.25) and the percentage of these vacancies at the maximum nonstoichiometry (82 mol%  $Al_2O_3$ ). On the alumina-rich side of this phase field, there is an excess of  $Al^{3+}$  ions, which means that some of the  $Al^{3+}$  ions substitute for  $Mg^{2+}$  ions. In order to maintain charge neutrality,  $Mg^{2+}$  vacancies are formed, and for every  $Mg^{2+}$  vacancy formed, two  $Al^{3+}$  ions substitute for three  $Mg^{2+}$  ions.

Now, we will calculate the percentage of  $Mg^{2+}$  vacancies that exist at 82 mol%  $Al_2O_3$ . Let us arbitrarily choose as our basis 50  $MgO$ - $Al_2O_3$  units of the stoichiometric material which consists of 50  $Mg^{2+}$  ions and 100  $Al^{3+}$  ions. Furthermore, let us designate the number of  $Mg^{2+}$  vacancies as  $x$ , which means that  $2x$   $Al^{3+}$  ions have been added and  $3x$   $Mg^{2+}$  ions have been removed (two of which are filled with  $Al^{3+}$  ions). Using our 50  $MgO$ - $Al_2O_3$  unit basis, the number of moles of  $Al_2O_3$  in the nonstoichiometric material is  $(100 + 2x)/2$ ; similarly the number of moles of  $MgO$  is  $(50 - 3x)$ . Thus, using a modified form of Equation (4.5), we may write an expression for the mole percent of  $Al_2O_3$  as

$$\text{mol\% } Al_2O_3 = \left[ \frac{\frac{100 + 2x}{2}}{\frac{100 + 2x}{2} + (50 - 3x)} \right] \times 100$$

If we solve for  $x$  when the mol% of  $\text{Al}_2\text{O}_3 = 82$ , then  $x = 12.1$ . Thus, adding  $2x$  or  $(2)(12.1) = 24.2$   $\text{Al}^{3+}$  ions to the original material consisting of 100  $\text{Al}^{3+}$  and 50  $\text{Mg}^{2+}$  ions will produce 12.1  $\text{Mg}^{2+}$  vacancies. Therefore, the percentage of vacancies is just

$$\% \text{ vacancies} = \frac{12.1}{100 + 50} \times 100 = 8.1\%$$

(b) Now, we are asked to make the same determinations for the MgO-rich side of the spinel phase field, for 40 mol%  $\text{Al}_2\text{O}_3$ . In this case,  $\text{Mg}^{2+}$  ions are substituting for  $\text{Al}^{3+}$  ions. Since the  $\text{Mg}^{2+}$  ion has a lower charge than the  $\text{Al}^{3+}$  ion, in order to maintain charge neutrality, negative charges must be eliminated, which may be accomplished by introducing  $\text{O}^{2-}$  vacancies. For every 2  $\text{Mg}^{2+}$  ions that substitute for 2  $\text{Al}^{3+}$  ions, one  $\text{O}^{2-}$  vacancy is formed.

Now, we will calculate the percentage of  $\text{O}^{2-}$  vacancies that exist at 40 mol%  $\text{Al}_2\text{O}_3$ . Let us arbitrarily choose as our basis 50  $\text{MgO-Al}_2\text{O}_3$  units of the stoichiometric material which consist of 50  $\text{Mg}^{2+}$  ions 100  $\text{Al}^{3+}$  ions. Furthermore, let us designate the number of  $\text{O}^{2-}$  vacancies as  $y$ , which means that  $2y$   $\text{Mg}^{2+}$  ions have been added and  $2y$   $\text{Al}^{3+}$  ions have been removed. Using our 50  $\text{MgO-Al}_2\text{O}_3$  unit basis, the number of moles of  $\text{Al}_2\text{O}_3$  in the nonstoichiometric material is  $(100 - 2y)/2$ ; similarly the number of moles of  $\text{MgO}$  is  $(50 + 2y)$ . Thus, the expression for the mole percent of  $\text{Al}_2\text{O}_3$  is just

$$\text{mol\% Al}_2\text{O}_3 = \left[ \frac{\frac{100 - 2y}{2}}{\frac{100 - 2y}{2} + (50 + 2y)} \right] \times 100$$

If we solve for  $y$  when the mole percent of  $\text{Al}_2\text{O}_3 = 40$ , then  $y = 7.14$ . Thus, 7.14  $\text{O}^{2-}$  vacancies are produced in the original material that had 200  $\text{O}^{2-}$  ions. Therefore, the percentage of vacancies is just

$$\% \text{ vacancies} = \frac{7.14}{200} \times 100 = 3.57\%$$

12.37 (a) There may be significant scatter in the fracture strength for some given ceramic material because the fracture strength depends on the probability of the existence of a flaw that is capable of initiating a crack; this probability varies from specimen to specimen of the same material.

(b) The fracture strength increases with decreasing specimen size because as specimen size decreases, the probability of the existence of a flaw of that is capable of initiating a crack diminishes.

12.38 We are asked for the critical crack tip radius for an  $\text{Al}_2\text{O}_3$  material. From Equation (8.1)

$$\sigma_m = 2\sigma_0 \left( \frac{a}{\rho_t} \right)^{1/2}$$

Fracture will occur when  $\sigma_m$  reaches the fracture strength of the material, which is given as  $E/10$ ; thus

$$\frac{E}{10} = 2\sigma_0 \left( \frac{a}{\rho_t} \right)^{1/2}$$

Or, solving for  $\rho_t$

$$\rho_t = \frac{400 a \sigma_0^2}{E^2}$$

From Table 12.5,  $E = 393 \text{ GPa}$ , and thus,

$$\begin{aligned} \rho_t &= \frac{(400)(2 \times 10^{-3} \text{ mm})(275 \text{ MPa})^2}{(393 \times 10^3 \text{ MPa})^2} \\ &= 3.9 \times 10^{-7} \text{ mm} = 0.39 \text{ nm} \end{aligned}$$

12.39 This problem asks that we compute the crack tip radius ratio before and after etching. Let

$\rho_t$  = original crack tip radius, and

$\rho_t'$  = etched crack tip radius

Also,

$$\sigma_f' = \sigma_f$$

$$a' = \frac{a}{2}$$

$$\sigma_0' = 4\sigma_0$$

Solving for  $\frac{\rho_t'}{\rho_t}$  from the following

$$\sigma_f = 2\sigma_o \left( \frac{a}{\rho_t} \right)^{1/2} = \sigma_f' = 2\sigma_o' \left( \frac{a'}{\rho_t'} \right)^{1/2}$$

yields

$$\frac{\rho_t'}{\rho_t} = \left( \frac{\sigma_o'}{\sigma_o} \right)^2 \left( \frac{a'}{a} \right) = \left( \frac{4\sigma_o}{\sigma_o} \right)^2 \left( \frac{a/2}{a} \right) = 8$$

12.40 (a) For this portion of the problem we are asked to compute the flexural strength for a glass specimen that is subjected to a three-point bending test. The flexural strength [Equation 12.3(a)] is just

$$\sigma_{fs} = \frac{3F_f L}{2bd^2}$$

for a rectangular cross-section. Using the values given in the problem,

$$\sigma_{fs} = \frac{(3)(290 \text{ N})(45 \times 10^{-3} \text{ m})}{(2)(10 \times 10^{-3} \text{ m})(5 \times 10^{-3} \text{ m})^2} = 78.3 \text{ MPa} \quad (10,660 \text{ psi})$$

(b) We are now asked to compute the maximum deflection. From Table 12.5, the elastic modulus ( $E$ ) for glass is 69 GPa ( $10 \times 10^6$  psi). Also, the moment of inertia for a rectangular cross section (Figure 12.29) is just

$$I = \frac{bd^3}{12}$$

Thus,

$$\Delta y = \frac{FL^3}{48E \left( \frac{bd^3}{12} \right)} = \frac{FL^3}{4Ebd^3}$$

$$= \frac{(266 \text{ N})(45 \times 10^{-3} \text{ m})^3}{(4)(69 \times 10^9 \text{ N/m}^2)(10 \times 10^{-3} \text{ m})(5 \times 10^{-3} \text{ m})^3}$$

$$= 7.0 \times 10^{-5} \text{ m} = 7.0 \times 10^{-2} \text{ mm} \quad (2.5 \times 10^{-3} \text{ in.})$$

12.41 We are asked to calculate the maximum radius of a circular specimen that is loaded using three-point bending. Solving for  $R$  from Equation (12.3b)

$$R = \left[ \frac{F_f L}{\sigma_{fs} \pi} \right]^{1/3}$$

which, when substituting the parameters stipulated in the problem, yields

$$R = \left[ \frac{(425 \text{ N})(50 \times 10^{-3} \text{ m})}{(105 \times 10^6 \text{ N/m}^2)\pi} \right]^{1/3}$$

$$= 4.0 \times 10^{-3} \text{ m} = 4.0 \text{ mm} \quad (0.16 \text{ in.})$$

12.42 For this problem, the load is given at which a circular specimen of aluminum oxide fractures when subjected to a three-point bending test; we are then asked to determine the load at which a specimen of the same material having a square cross-section fractures. It is first necessary to compute the flexural strength of the alumina using Equation (12.3b), and then, using this value, we may calculate the value of  $F_f$  in Equation (12.3a). From Equation (12.3b)

$$\sigma_{fs} = \frac{F_f L}{\pi R^3}$$

$$= \frac{(3000 \text{ N})(40 \times 10^{-3} \text{ m})}{(\pi)(5.0 \times 10^{-3} \text{ m})^3} = 306 \times 10^6 \text{ N/m}^2 = 306 \text{ MPa} \quad (42,970 \text{ psi})$$

Now, solving for  $F_f$  from Equation (12.3a), realizing that  $b = d = 12 \text{ mm}$ , yields

$$F_f = \frac{2\sigma_{fs}d^3}{3L}$$

$$= \frac{(2) (306 \times 10^6 \text{ N/m}^2) (15 \times 10^{-3} \text{ m})^3}{(3) (40 \times 10^{-3} \text{ m})} = 17,200 \text{ N} \quad (3870 \text{ lb}_f)$$

12.43 (a) This portion of the problem asks that we determine whether or not a cylindrical specimen of aluminum oxide having a flexural strength of 300 MPa (43,500 psi) and a radius of 5 mm will fracture when subjected to a load of 7500 N in a three-point bending test; the support point separation is given as 15 mm. Using Equation (12.3b) we will calculate the value of  $\sigma$ ; if this value is greater than  $\sigma_{fs}$  (300 MPa), then fracture is expected to occur. Employment of Equation (12.3b) yields

$$\sigma = \frac{FL}{\pi R^3} = \frac{(7500 \text{ N})(15 \times 10^{-3} \text{ m})}{(\pi)(5 \times 10^{-3} \text{ m})^3} = 286.5 \times 10^6 \text{ N/m}^2 = 286.5 \text{ MPa} \quad (40,300 \text{ psi})$$

Since this value is less than the given value of  $\sigma_{fs}$  (300 MPa), then fracture is not predicted.

(b) The certainty of this prediction is not 100% because there is always some variability in the flexural strength for ceramic materials, and since this value of  $\sigma$  is relatively close to  $\sigma_{fs}$  then there is some chance that fracture will occur.

12.44 Crystalline ceramics are harder yet more brittle than metals because they (ceramics) have fewer slip systems, and, therefore, dislocation motion is highly restricted.

12.45 (a) This portion of the problem requests that we compute the modulus of elasticity for nonporous spinel given that  $E = 240 \text{ GPa}$  for a material having 5 vol% porosity. Thus, we solve Equation (12.5) for  $E_o$ , using  $P = 0.05$ , which gives

$$E_o = \frac{E}{1 - 1.9P + 0.9P^2}$$

$$= \frac{240 \text{ GPa}}{1 - (1.9)(0.05) + (0.9)(0.05)^2} = 265 \text{ GPa} \quad (38.6 \times 10^6 \text{ psi})$$

(b) Now we are asked to determine the value of  $E$  at  $P = 15 \text{ vol\%}$ . Using Equation (12.5) we get

$$E = E_o (1 - 1.9P + 0.9P^2)$$

$$= (265 \text{ GPa}) \left[ 1 - (1.9)(0.15) + (0.09)(0.15)^2 \right] = 195 \text{ GPa} \quad (28.4 \times 10^6 \text{ psi})$$

12.46 (a) This portion of the problem requests that we compute the modulus of elasticity for nonporous TiC given that  $E = 310 \text{ GPa}$  ( $45 \times 10^6 \text{ psi}$ ) for a material having 5 vol% porosity. Thus, we solve Equation (12.5) for  $E_o$ , using  $P = 0.05$ , which gives

$$E_o = \frac{E}{1 - 1.9P + 0.9P^2}$$

$$= \frac{310 \text{ GPa}}{1 - (1.9)(0.05) + (0.9)(0.05)^2} = 342 \text{ GPa} \quad (49.6 \times 10^6 \text{ psi})$$

(b) Now we are asked to compute the volume percent porosity at which the elastic modulus of TiC is 240 MPa ( $35 \times 10^6 \text{ psi}$ ). Since from part (a),  $E_o = 342 \text{ GPa}$ , and using Equation (12.5) we get

$$\frac{E}{E_o} = \frac{240 \text{ MPa}}{342 \text{ MPa}} = 0.702 = 1 - 1.9P + 0.9P^2$$

Or

$$0.9P^2 - 1.9P + 0.298 = 0$$

Now, solving for the value of  $P$  using the quadratic equation solution yields

$$P = \frac{1.9 \pm \sqrt{(-1.9)^2 - (4)(0.9)(0.298)}}{(2)(0.9)}$$

The positive and negative roots are

$$P^+ = 1.94$$

$$P^- = 0.171$$

Obviously, only the negative root is physically meaningful, and therefore the value of the porosity to give the desired modulus of elasticity is 17.1 vol%.

12.47 (a) This part of the problem asks us to determine the flexural strength of nonporous MgO assuming that the value of  $n$  in Equation (12.6) is 3.75. Taking natural logarithms of both sides of Equation (12.6) yields

$$\ln \sigma_{fs} = \ln \sigma_o - nP$$

In Table 12.5 it is noted that for  $P = 0.05$ ,  $\sigma_{fs} = 105$  MPa. For the nonporous material  $P = 0$  and,  $\ln \sigma_o = \ln \sigma_{fs}$ . Solving for  $\ln \sigma_o$  from the above equation and using these data gives

$$\begin{aligned} \ln \sigma_o &= \ln \sigma_{fs} + nP \\ &= \ln (105 \text{ MPa}) + (3.75)(0.05) = 4.841 \end{aligned}$$

$$\text{or } \sigma_o = e^{4.841} = 127 \text{ MPa (18,100 psi)}$$

(b) Now we are asked to compute the volume percent porosity to yield a  $\sigma_{fs}$  of 74 MPa (10,700 psi).

Taking the natural logarithm of Equation (12.6) and solving for  $P$  leads to

$$\begin{aligned} P &= \frac{\ln \sigma_o - \ln \sigma_{fs}}{n} \\ &= \frac{\ln (127 \text{ MPa}) - \ln (74 \text{ MPa})}{3.75} \\ &= 0.144 \text{ or } 14.4 \text{ vol\%} \end{aligned}$$

12.48 (a) Given the flexural strengths at two different volume fraction porosities, we are asked to determine the flexural strength for a nonporous material. If the natural logarithm is taken of both sides of Equation (12.6), then

$$\ln \sigma_{fs} = \ln \sigma_o - nP$$

Using the data provided in the problem, two simultaneous equations may be written as

$$\ln (100 \text{ MPa}) = \ln \sigma_o - (0.05)n$$

$$\ln (50 \text{ MPa}) = \ln \sigma_o - (0.20)n$$

Solving for  $n$  and  $\sigma_o$  leads to  $n = 4.62$  and  $\sigma_o = 126$  MPa. For the nonporous material,  $P = 0$ , and, from Equation (12.6),  $\sigma_o = \sigma_{fs}$ . Thus,  $\sigma_{fs}$  for  $P = 0$  is 126 MPa.



(b) Now, we are asked for  $\sigma_{fs}$  at  $P = 0.1$  for this same material. Utilizing Equation (12.6) yields

$$\begin{aligned}\sigma_{fs} &= \sigma_o \exp(-nP) \\ &= (126 \text{ MPa}) \exp[-(4.62)(0.1)] \\ &= 79.4 \text{ MPa}\end{aligned}$$

### Design Problems

12.D1 This problem asks that we determine the concentration (in weight percent) of GaP that must be added to GaAs to yield a unit cell edge length of 0.5570 nm. The densities of GaAs and GaP were given in the problem as 5.307 and 4.130 g/cm<sup>3</sup>, respectively. To begin, it is necessary to employ Equation (12.1), and solve for the unit cell volume,  $V_C$ , for the GaP-GaAs alloy as

$$V_C = \frac{n' A_{ave}}{\rho_{ave} N_A}$$

where  $A_{ave}$  and  $\rho_{ave}$  are the atomic weight and density, respectively, of the GaAs-GaP alloy.

Inasmuch as both of these materials have the zinc blende crystal structure, which has cubic symmetry,  $V_C$  is just the cube of the unit cell length,  $a$ . That is

$$\begin{aligned}V_C &= a^3 = (0.5570 \text{ nm})^3 \\ &= (5.570 \times 10^{-8} \text{ cm})^3 = 1.728 \times 10^{-22} \text{ cm}^3\end{aligned}$$

It is now necessary to construct expressions for  $A_{ave}$  and  $\rho_{ave}$  in terms of the concentration of gallium phosphide,  $C_{GaP}$  using Equations (4.11a) and (4.10a). For  $A_{ave}$  we have

$$A_{ave} = \frac{100}{\frac{C_{GaP}}{A_{GaP}} + \frac{(100 - C_{GaP})}{A_{GaAs}}}$$

$$= \frac{100}{\frac{C_{\text{GaP}}}{100.69 \text{ g/mol}} + \frac{(100 - C_{\text{GaP}})}{144.64 \text{ g/mol}}}$$

Whereas for  $\rho_{\text{ave}}$

$$\rho_{\text{ave}} = \frac{100}{\frac{C_{\text{GaP}}}{\rho_{\text{GaP}}} + \frac{(100 - C_{\text{GaP}})}{\rho_{\text{GaAs}}}}$$

$$= \frac{100}{\frac{C_{\text{GaP}}}{4.130 \text{ g/cm}^3} + \frac{(100 - C_{\text{GaP}})}{5.307 \text{ g/cm}^3}}$$

Within the zinc blende unit cell there are four formula units, and thus, the value of  $n'$  in Equation (12.1) is 4; hence, this expression may be written in terms of the concentration of GaP in weight percent as follows:

$$V_C = 1.728 \times 10^{-22} \text{ cm}^3$$

$$= \frac{n' A_{\text{ave}}}{\rho_{\text{ave}} N_A}$$

$$= \frac{(4 \text{ fu/unitcell}) \left[ \frac{100}{\frac{C_{\text{GaP}}}{100.69 \text{ g/mol}} + \frac{(100 - C_{\text{GaP}})}{144.64 \text{ g/mol}}} \right]}{\left[ \frac{100}{\frac{C_{\text{GaP}}}{4.130 \text{ g/cm}^3} + \frac{(100 - C_{\text{GaP}})}{5.307 \text{ g/cm}^3}} \right] (6.023 \times 10^{23} \text{ fu/mole})}$$

And solving this expression for  $C_{\text{GaP}}$  leads to  $C_{\text{GaP}} = 34 \text{ wt}\%$ .

12.D2 This problem asks for us to determine which of the ceramic materials in Table 12.5, when fabricated into cylindrical specimens and stressed in three-point loading, will not fracture when a load of 445 N (100 lbf) is applied, and also will not experience a center-point deflection of more than

0.021 mm ( $8.5 \times 10^{-4}$  in.). The first of these criteria is met by those materials that have flexural strengths greater than the stress calculated using Equation (12.3b). According to this expression

$$\sigma_{fs} = \frac{FL}{\pi R^3}$$

$$= \frac{(445 \text{ N})(50.8 \times 10^{-3} \text{ m})}{(\pi)(3.8 \times 10^{-3} \text{ m})^3} = 131 \times 10^6 \text{ N/m}^2 = 131 \text{ MPa (18,900 psi)}$$

Of the materials in Table 12.5 the following have flexural strengths greater than this value:  $\text{Si}_3\text{N}_4$ ,  $\text{ZrO}_2$ , SiC,  $\text{Al}_2\text{O}_3$ , glass-ceramic, mullite, and spinel.

For the second criterion we must solve for the magnitude of the modulus of elasticity,  $E$ , from the equation given in Problem 12.40 where the expression for the cross-sectional moment of inertia appears in Figure 12.29; that is, for a circular cross-section  $I = \frac{\pi R^4}{4}$ . Solving for  $E$  from these two expressions

$$E = \frac{FL^3}{12\pi R^4 \Delta y}$$

$$= \frac{(445 \text{ N})(50.8 \times 10^{-3} \text{ m})^3}{(12)(\pi)(3.8 \times 10^{-3} \text{ m})^4 (0.021 \times 10^{-3} \text{ m})}$$

$$= 353 \times 10^9 \text{ N/m}^2 = 353 \text{ GPa (49.3} \times 10^6 \text{ psi)}$$

Of those materials that satisfy the first criterion, only  $\text{Al}_2\text{O}_3$  has a modulus of elasticity greater than this value (Table 12.5), and, therefore, is a possible candidate.

## CHAPTER 13

### APPLICATIONS AND PROCESSING OF CERAMICS

#### PROBLEM SOLUTIONS

- 13.1 The two desirable characteristics of glasses are optical transparency and ease of fabrication.
- 13.2 (a) Devitrification is the process whereby a glass material is caused to transform to a crystalline solid, usually by a heat treatment.
- (b) Two properties that may be improved by devitrification are 1) a lower coefficient of thermal expansion, and 2) a higher thermal conductivity. Two properties that may be impaired are 1) a loss of optical transparency, and 2) a lowering of mechanical strength when stresses are introduced from volume changes that attend the transformation. In some cases, however, strength may actually be improved.
- 13.3 Glass-ceramics may not be transparent because they are polycrystalline. Light will be scattered at grain boundaries in polycrystalline materials if the index of refraction is anisotropic, and when those grains adjacent to the boundary have different crystallographic orientations. This phenomenon is discussed in Section 21.10.
- 13.4 For refractory ceramic materials, three characteristics that improve with increasing porosity are decreased thermal expansion and contraction upon thermal cycling, improved thermal insulation, and resistance to thermal shock. Two characteristics that are adversely affected are load-bearing capacity and resistance to attack by corrosive materials.
- 13.5 (a) From Figure 12.25, the maximum temperature without a liquid phase corresponds to the temperature at the  $\text{MgO(ss)}\text{-}[\text{MgO(ss)} + \text{Liquid}]$  boundary at this composition, which is approximately  $2240^\circ\text{C}$  ( $4060^\circ\text{F}$ ).
- (b) This maximum temperature lies at the phase boundary between  $\text{MgAl}_2\text{O}_4\text{(ss)}\text{-}(\text{MgAl}_2\text{O}_4 + \text{Liquid})$  phase fields (just slightly to the right of the congruent melting point at which the two phase boundaries become tangent); this temperature is approximately  $2090^\circ\text{C}$  ( $3790^\circ\text{F}$ ).
- 13.6 For each section of this problem two  $\text{SiO}_2\text{-Al}_2\text{O}_3$  compositions are given; we are to decide, on the basis of the  $\text{SiO}_2\text{-Al}_2\text{O}_3$  phase diagram (Figure 12.27), which is the more desirable as a refractory and then justify the choice.

(a) The 99.8 wt% SiO<sub>2</sub>-0.2 wt% Al<sub>2</sub>O<sub>3</sub> will be more desirable because the liquidus temperature will be greater for this composition; therefore, at any temperature within the cristobalite + liquid region on the phase diagram, there will be a lower fraction of the liquid phase present than for the 99.0 wt% SiO<sub>2</sub>-1.0 wt% Al<sub>2</sub>O<sub>3</sub> composition, and, thus, the mechanical integrity will be greater.

(b) The 74 wt% Al<sub>2</sub>O<sub>3</sub>-26 wt% SiO<sub>2</sub> composition will be more desirable because, for this composition, a liquid phase does not form until about 1750°C [i.e., the temperature at which a vertical line at 74 wt% Al<sub>2</sub>O<sub>3</sub> crosses the boundary between the mullite and (mullite + liquid) phase regions]; for the 70 wt% Al<sub>2</sub>O<sub>3</sub>-30 wt% SiO<sub>2</sub> material, a liquid phase forms at a much lower temperature--1587°C.

(c) The 95 wt% Al<sub>2</sub>O<sub>3</sub>-5 wt% SiO<sub>2</sub> composition will be more desirable because the liquidus temperature will be greater for this composition. Therefore, at any temperature within the alumina + liquid region on the phase diagram, there will be a lower fraction of the liquid phase present than for the 90 wt% Al<sub>2</sub>O<sub>3</sub>-10 wt% SiO<sub>2</sub> composition, and, thus, the mechanical integrity of the 95 wt% Al<sub>2</sub>O<sub>3</sub>-5 wt% SiO<sub>2</sub> material will be greater.

13.7 This problem calls for us to compute the mass fractions of liquid for two fireclay refractory materials at 1600°C. In order to solve this problem it is necessary that we use the SiO<sub>2</sub>-Al<sub>2</sub>O<sub>3</sub> phase diagram (Figure 12.27). The mass fraction of liquid, **W<sub>L</sub>**, as determined using the lever rule and tie line at 1600°C, is just

$$W_L = \frac{C_{\text{mullite}} - C_o}{C_{\text{mullite}} - C_L}$$

where **C<sub>mullite</sub>** = 72 wt% Al<sub>2</sub>O<sub>3</sub> and **C<sub>L</sub>** = 8 wt% Al<sub>2</sub>O<sub>3</sub>, as determined using the tie-line; also, **C<sub>o</sub>** is the composition (in weight percent Al<sub>2</sub>O<sub>3</sub>) of the refractory material.

(a) For the 25 wt% Al<sub>2</sub>O<sub>3</sub>- 75 wt% SiO<sub>2</sub> composition, **C<sub>o</sub>** = 25 wt% Al<sub>2</sub>O<sub>3</sub>, and

$$W_L = \frac{72 - 25}{72 - 8} = 0.73$$

(b) For the 45 wt% Al<sub>2</sub>O<sub>3</sub>- 55 wt% SiO<sub>2</sub> composition, **C<sub>o</sub>** = 45 wt% Al<sub>2</sub>O<sub>3</sub>, and

$$W_L = \frac{72 - 45}{72 - 8} = 0.42$$

13.8 (a) This portion of the problem asks that we specify, for the  $\text{SiO}_2\text{-Al}_2\text{O}_3$  system, the maximum temperature possible without the formation of a liquid phase. According to Figure 12.27 this maximum temperature is  $1890^\circ\text{C}$ , which is possible for compositions between about 77  $\text{Al}_2\text{O}_3$  and virtually 100 wt%  $\text{Al}_2\text{O}_3$ .

(b) For the  $\text{MgO-Al}_2\text{O}_3$  system, Figure 12.25, the maximum temperature without the formation of a liquid phase is approximately  $2800^\circ\text{C}$  which is possible for pure  $\text{MgO}$ .

13.9 For clay-based aggregates, a liquid phase forms during firing, which infiltrates the pores between the unmelted particles; upon cooling, this liquid becomes a glass, which serves as the bonding phase.

With cements, the bonding process is a chemical, hydration reaction between the water that has been added and the various cement constituents. The cement particles are bonded together by reactions that occur at the particle surfaces.

13.10 It is important to grind cement into a fine powder in order to increase the surface area of the particles of cement. The hydration reactions between water and the cement occur at the surface of the cement particles. Therefore, increasing the available surface area allows for more extensive bonding.

13.11 We are asked to compute the weight of soda ash and limestone that must be added to 100  $\text{lb}_m$  of  $\text{SiO}_2$  to yield a glass composition of 75 wt%  $\text{SiO}_2$ , 15 wt%  $\text{Na}_2\text{O}$ , and 10 wt%  $\text{CaO}$ . Inasmuch as the concentration of  $\text{SiO}_2$  in the glass is 75wt%, the final weight of the glass ( $m_{\text{glass}}$ ) is just

$$m_{\text{glass}} = \frac{100 \text{ lb}_m}{0.75} = 133.3 \text{ lb}_m$$

Therefore, the weights of  $\text{Na}_2\text{O}$  ( $m_{\text{Na}_2\text{O}}$ ) and  $\text{CaO}$  ( $m_{\text{CaO}}$ ) are as follows:

$$m_{\text{Na}_2\text{O}} = \left( \frac{15 \text{ wt}\%}{100} \right) (133.3 \text{ lb}_m) = 20.0 \text{ lb}_m$$

and

$$m_{\text{CaO}} = \left( \frac{10 \text{ wt}\%}{100} \right) (133.3 \text{ lb}_m) = 13.3 \text{ lb}_m$$

In order to compute the weights of  $\text{Na}_2\text{CO}_3$  and  $\text{CaCO}_3$  we must employ molecular weights, as

$$m_{\text{Na}_2\text{CO}_3} = (20.0 \text{ lb}_m) \left( \frac{\text{molecular wt. Na}_2\text{CO}_3}{\text{molecular wt. Na}_2\text{O}} \right)$$

$$= (20.0 \text{ lb}_m) \left( \frac{105.99 \text{ g/mol}}{61.98 \text{ g/mol}} \right) = 34.2 \text{ lb}_m$$

and

$$m_{\text{CaCO}_3} = (13.3 \text{ lb}_m) \left( \frac{\text{molecular wt. CaCO}_3}{\text{molecular wt. CaO}} \right)$$

$$= (13.3 \text{ lb}_m) \left( \frac{100.09 \text{ g/mol}}{56.08 \text{ g/mol}} \right) = 23.8 \text{ lb}_m$$

13.12 The glass transition temperature is, for a noncrystalline ceramic, that temperature at which there is a change of slope for the specific volume versus temperature curve (Figure 13.5).

The melting temperature is, for a crystalline material, that temperature at which there is a sudden and discontinuous decrease in the specific volume versus temperature curve.

13.13 In order to be drawn into fibers, a material must exist as a viscous fluid. Crystalline aluminum oxide is a solid below its melting temperature and a nonviscous fluid above. On the other hand, a glass will be a viscous fluid as a supercooled liquid.

13.14 The annealing point is that temperature at which the viscosity of the glass is  $10^{12}$  Pa-s ( $10^{13}$  P).

From Figure 13.6, these temperatures for the several glasses are as follows:

<u>Glass</u>	<u>Annealing Temperature</u>
Soda-lime	500°C (930°F)
Borosilicate	570°C (1060°F)
96% Silica	930°C (1705°F)
Fused Silica	1170°C (2140°F)

13.15 The softening point of a glass is that temperature at which the viscosity is  $4 \times 10^6$  Pa-s; from Figure 13.6, these temperatures for the 96% silica, borosilicate, and soda-lime glasses are 1540°C (2800°F), 830°C (1525°F), and 700°C (1290°F), respectively.

13.16 (a) Below is shown the logarithm viscosity versus reciprocal of temperature plot for the borosilicate glass, using the data in Figure 13.6.

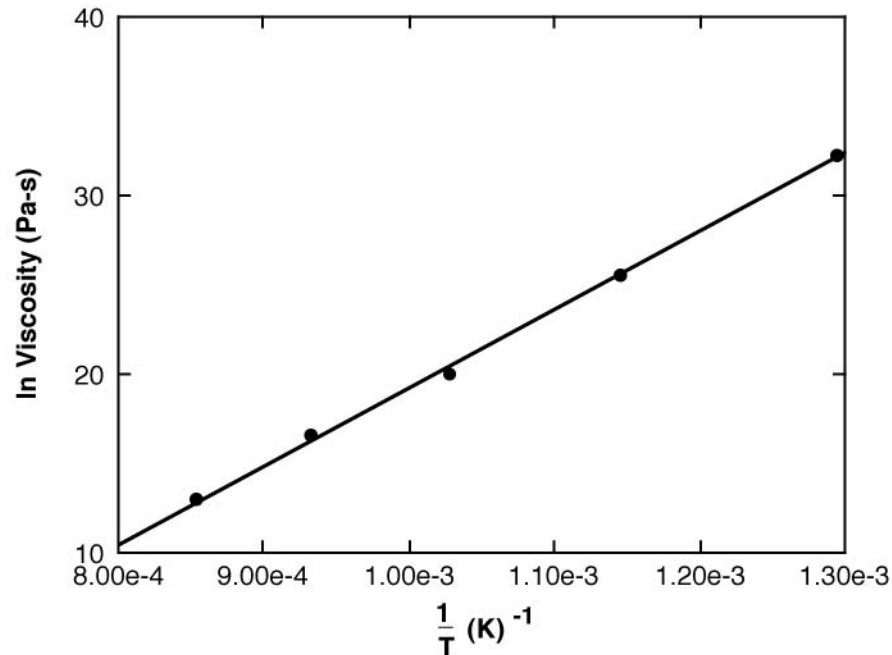

(b) The activation energy,  $Q_{vis}$ , may be computed from this plot according to

$$Q_{vis} = R \left[ \frac{\Delta \ln \eta}{\Delta \left( \frac{1}{T} \right)} \right]$$

where  $R$  is the gas constant, and  $\Delta \ln \eta / \Delta (1/T)$  is the slope of the line that has been constructed. The value of this slope is  $4.36 \times 10^4 \text{ K}$ . Therefore,

$$\begin{aligned} Q_{vis} &= (8.31 \text{ J/mol-K}) (4.36 \times 10^4 \text{ K}) \\ &= 362,000 \text{ J/mol} \end{aligned}$$

13.17 This problem calls for us to determine the maximum temperature to which a cylindrical specimen of soda-lime glass may be heated in order that its deformation be less than 1 mm over a week's time. According to Equation (6.1)



$$\sigma = \frac{F}{A_o} = \frac{1 \text{ N}}{\pi \left( \frac{5 \times 10^{-3} \text{ m}}{2} \right)^2} = 5.1 \times 10^4 \text{ Pa}$$

Also,

$$\frac{d\varepsilon}{dt} = \frac{d(\Delta l/l_o)}{dt}$$

$$= \frac{1 \text{ mm}/100 \text{ mm}}{(1 \text{ wk})(7 \text{ days/week})(24 \text{ h/day})(3600 \text{ s/h})} = 1.653 \times 10^{-8} \text{ s}^{-1}$$

Thus,

$$\eta = \frac{\sigma}{d\varepsilon/dt} = \frac{5.1 \times 10^4 \text{ Pa}}{1.653 \times 10^{-8} \text{ s}^{-1}} = 3.1 \times 10^{12} \text{ Pa-s}$$

From Figure 13.6, the temperature at which the viscosity of the soda-lime glass is  $3.1 \times 10^{12}$  Pa-s is about 500°C (930°F).

13.18 (a) Residual thermal stresses are introduced into a glass piece when it is cooled because surface and interior regions cool at different rates, and, therefore, contract different amounts; since the material will experience very little, if any deformation, stresses are established.

(b) Yes, thermal stresses will be introduced because of thermal expansion upon heating for the same reason as for thermal contraction upon cooling.

(c) The thinner the thickness of a glass ware the smaller the thermal stresses that are introduced when it is either heated or cooled. The reason for this is that the difference in temperature across the cross-section of the ware, and, therefore, the difference in the degree of expansion or contraction will decrease with a decrease in thickness.

13.19 Borosilicate glasses and fused silica are resistant to thermal shock because they have relatively low coefficients of thermal expansion; therefore, upon heating or cooling, the difference in the degree of expansion or contraction across the cross-section of a ware that is constructed from these materials will be relatively low.

13.20 Thermal tempering of glasses is described in Section 13.8.

13.21 Chemical tempering will be accomplished by substitution, for  $\text{Na}^+$ , another monovalent cation with a slightly larger diameter. From Table 12.3, both  $\text{K}^+$  and  $\text{Cs}^+$  fill this criterion, having ionic radii of 0.138 and 0.170 nm, respectively. In fact, soda-lime glasses are tempered using a  $\text{K}^+$ - $\text{Na}^+$  ion exchange.

13.22 Two desirable characteristics of clay minerals relative to fabrication processes are 1) they become hydroplastic (and therefore formable) when mixed with water; and 2) during firing, a clay melts over a range of temperatures, which allows some fusion and bonding of a ware without complete melting and a loss of mechanical integrity and shape.

13.23 Clays become hydroplastic when water is added because the water molecules fill in regions between the layered molecular sheets; these water molecules essentially eliminate the secondary molecular bonds between adjacent sheets, and also form a thin film around the clay particles. The net result is that the clay particles are relatively free to move past one another, which is manifested as the hydroplasticity phenomenon.

13.24 Upon drying, thick ceramic wares are more likely to crack upon drying than thin wares because of a greater difference in shrinkage between surface and interior cross-sectional regions for the thick ware. Water being eliminated during drying has a longer distance to travel from the interior to the surface for the thicker ware.

13.25 The phenomenon of hydroplasticity results when water molecules form a thin film around the small clay particles. During firing, these individual particles become fused together by the viscous liquid that fills in the pore volume between the particles--the pore volume occupied by water in the hydroplastic state. This viscous liquid forms a glass matrix on subsequent cooling.

13.26 (a) The three components of a whiteware ceramic are clay, quartz, and a flux.

(b) With regard to the role that each component plays:

Quartz acts as a filler material.

Clay facilitates the forming operation since, when mixed with water, the mass may be made to become either hydroplastic or form a slip. Also, since clays melt over a range of temperatures, the shape of the piece being fired will be maintained.

The flux facilitates the formation of a glass having a relatively low melting temperature.

13.27 (a) It is important to control the rate of drying inasmuch as if the rate of drying is too rapid, there will be nonuniform shrinkage between surface and interior regions, such that warping and/or cracking of the ceramic ware will result.

(b) Three factors that affect the rate of drying are temperature, humidity, and rate of air flow. The rate of drying is enhanced by increasing both the temperature and rate of air flow, and by decreasing the humidity of the air.

13.28 The reason that drying shrinkage is greater for products having smaller clay particles is that there is more particle surface area, and, consequently, more water will surround a given volume of particles. The drying shrinkage will thus be greater as this water is removed, and as the interparticle separation decreases.

13.29 (a) Three factors that influence the degree to which vitrification occurs in clay-based ceramic wares are: 1) the composition (especially the concentration of flux present); 2) the temperature of firing; and 3) the time at the firing temperature.

(b) Density will increase with degree of vitrification since the total remaining pore volume decreases.

Firing distortion will increase with degree of vitrification since more liquid phase will be present at the firing temperature.

Strength will also increase with degree of vitrification inasmuch as more of the liquid phase forms, which fills in a greater fraction of pore volume. Upon cooling, the liquid forms a glass matrix of relatively high strength.

Corrosion resistance normally increases also, especially at service temperatures below that at which the glass phase begins to soften. The rate of corrosion is dependent on the amount of surface area exposed to the corrosive medium; hence, decreasing the total surface area by filling in some of the surface pores, diminishes the corrosion rate.

Thermal conductivity will increase with degree of vitrification. The glass phase has a higher conductivity than the pores that it has filled.

13.30 The principal disadvantage of hot-isostatic pressing is that it is expensive. The pressure is applied on a pre-formed green piece by a gas. Thus, the process is slow, and the equipment required to supply the gas and withstand the elevated temperature and pressure is costly.

#### Design Problem

13.D1 (a) Important characteristics that are required of a ceramic material to be used for kitchen cookware are: 1) it must have a high resistance to thermal shock (Section 19.5) in order to

withstand relatively rapid changes in temperature; 2) it must have a relatively high thermal conductivity; 3) it must be relatively strong and tough in order to endure normal kitchen use; and 4) it must be nontoxic.

(b) Possible materials worth considering are a common soda-lime glass, a borosilicate (Pyrex) glass, and a glass ceramic. These materials and some of their characteristics are discussed in this chapter. Using Equation (19.9) a comparison of the resistance to thermal shock may be made. The student will need to obtain cost information.

(c) It is left to the student to make this determination and justify the decision.

CHAPTER 14

**POLYMER STRUCTURES**

PROBLEM SOLUTIONS

14.1 **Polymorphism** is when two or more crystal structures are possible for a material of given composition. **Isomerism** is when two or more polymer molecules or mer units have the same composition, but different atomic arrangements.

14.2 The mer structures called for are sketched below.

(a) Polyvinyl fluoride

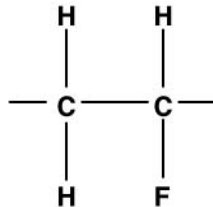

(b) Polychlorotrifluoroethylene

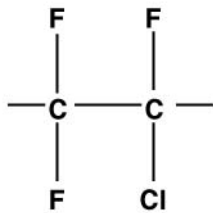

(c) Polyvinyl alcohol

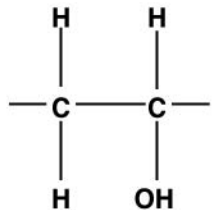

14.3 Mer weights for several polymers are asked for in this problem.

(a) For polytetrafluoroethylene, each mer unit consists of two carbons and four fluorines (Table 14.3). If  $A_C$  and  $A_F$  represent the atomic weights of carbon and fluorine, respectively, then

$$\begin{aligned}m &= 2(A_C) + 4(A_F) \\ &= (2)(12.01 \text{ g/mol}) + (4)(19.00 \text{ g/mol}) = 100.02 \text{ g/mol}\end{aligned}$$

(b) For polymethyl methacrylate, from Table 14.3, each mer unit has five carbons, eight hydrogens, and two oxygens. Thus,

$$\begin{aligned}m &= 5(A_C) + 8(A_H) + 2(A_O) \\ &= (5)(12.01 \text{ g/mol}) + (8)(1.008 \text{ g/mol}) + (2)(16.00 \text{ g/mol}) = 100.11 \text{ g/mol}\end{aligned}$$

(c) For nylon 6,6, from Table 14.3, each mer unit has twelve carbons, twenty-two hydrogens, two nitrogens, and two oxygens. Thus,

$$\begin{aligned}m &= 12(A_C) + 22(A_H) + 2(A_N) + 2(A_O) \\ &= (12)(12.01 \text{ g/mol}) + (22)(1.008 \text{ g/mol}) + (2)(14.01 \text{ g/mol}) + (2)(16.00 \text{ g/mol}) \\ &= 226.32 \text{ g/mol}\end{aligned}$$

(d) For polyethylene terephthalate, from Table 14.3, each mer unit has ten carbons, eight hydrogens, and four oxygens. Thus,

$$\begin{aligned}m &= 10(A_C) + 8(A_H) + 4(A_O) \\ &= (10)(12.01 \text{ g/mol}) + (8)(1.008 \text{ g/mol}) + (4)(16.00 \text{ g/mol}) = 192.16 \text{ g/mol}\end{aligned}$$

14.4 We are asked to compute the number-average degree of polymerization for polypropylene, given that the number-average molecular weight is 1,000,000 g/mol. The mer molecular weight of polypropylene is just

$$m = 3(A_C) + 6(A_H)$$

$$= (3)(12.01 \text{ g/mol}) + (6)(1.008 \text{ g/mol}) = 42.08 \text{ g/mol}$$

If we let  $n_n$  represent the number-average degree of polymerization, then from Equation (14.4a)

$$n_n = \frac{\bar{M}_n}{m} = \frac{10^6 \text{ g/mol}}{42.08 \text{ g/mol}} = 23,700$$

14.5 (a) The mer molecular weight of polystyrene is called for in this portion of the problem. For polystyrene, from Table 14.3, each mer unit has eight carbons and eight hydrogens. Thus,

$$m = 8(A_C) + 8(A_H)$$

$$= (8)(12.01 \text{ g/mol}) + (8)(1.008 \text{ g/mol}) = 104.14 \text{ g/mol}$$

(b) We are now asked to compute the weight-average molecular weight. Since the weight-average degree of polymerization,  $n_w$ , is 25,000, using Equation (14.4b)

$$\bar{M}_w = n_w m = (25,000)(104.14 \text{ g/mol}) = 2.60 \times 10^6 \text{ g/mol}$$

14.6 (a) From the tabulated data, we are asked to compute  $\bar{M}_n$ , the number-average molecular weight.

This is carried out below.

Molecular wt Range	Mean $M_i$	$x_i$	$x_i M_i$
8,000-16,000	12,000	0.05	600
16,000-24,000	20,000	0.16	3200
24,000-32,000	28,000	0.24	6720
32,000-40,000	36,000	0.28	10,080
40,000-48,000	44,000	0.20	8800
48,000-56,000	52,000	0.07	3640

---

$$\bar{M}_n = \sum x_i M_i = 33,040 \text{ g/mol}$$

(b) From the tabulated data, we are asked to compute  $\bar{M}_w$ , the weight-average molecular weight.

Molecular wt. Range	Mean $M_i$	$w_i$	$w_i M_i$
8,000-16,000	12,000	0.02	240
16,000-24,000	20,000	0.10	2000
24,000-32,000	28,000	0.20	5600
32,000-40,000	36,000	0.30	10,800
40,000-48,000	44,000	0.27	11,880
48,000-56,000	52,000	0.11	5720

---

$$\bar{M}_w = \sum w_i M_i = 36,240 \text{ g/mol}$$

(c) Now we are asked to compute  $n_n$  (the number-average degree of polymerization), using the Equation (14.4a). For polypropylene,

$$m = 3(A_C) + 6(A_H)$$

$$= (3)(12.01 \text{ g/mol}) + (6)(1.008 \text{ g/mol}) = 42.08 \text{ g/mol}$$

And

$$n_n = \frac{\bar{M}_n}{m} = \frac{33,040 \text{ g/mol}}{42.08 \text{ g/mol}} = 785$$

(d) And, finally, we are asked to compute  $n_w$ , the weight-average degree of polymerization, which, using Equation (14.4b), is just

$$n_w = \frac{\bar{M}_w}{m} = \frac{36,240 \text{ g/mol}}{42.08 \text{ g/mol}} = 861$$

14.7 (a) From the tabulated data, we are asked to compute  $\bar{M}_n$ , the number-average molecular weight.

This is carried out below.



Molecular wt. Range	Mean $M_i$	$x_i$	$x_i M_i$
8,000-20,000	14,000	0.05	700
20,000-32,000	26,000	0.15	3900
32,000-44,000	38,000	0.21	7980
44,000-56,000	50,000	0.28	14,000
56,000-68,000	62,000	0.18	11,160
68,000-80,000	74,000	0.10	7400
80,000-92,000	86,000	0.03	2580

---

$$\bar{M}_n = \sum x_i M_i = 47,720 \text{ g/mol}$$

(b) From the tabulated data, we are asked to compute  $\bar{M}_w$ , the weight- average molecular weight.

This determination is performed as follows:

Molecular wt. Range	Mean $M_i$	$w_i$	$w_i M_i$
8,000-20,000	14,000	0.02	280
20,000-32,000	26,000	0.08	2080
32,000-44,000	38,000	0.17	6460
44,000-56,000	50,000	0.29	14,500
56,000-68,000	62,000	0.23	14,260
68,000-80,000	74,000	0.16	11,840
80,000-92,000	86,000	0.05	4300

---

$$\bar{M}_w = \sum w_i M_i = 53,720 \text{ g/mol}$$

(c) We are now asked if the number-average degree of polymerization is 477, which of the polymers in Table 14.3 is this material? It is necessary to compute  $\bar{m}$  in Equation (14.4a) as

$$\bar{m} = \frac{\bar{M}_n}{M_0} = \frac{47,720 \text{ g/mol}}{477} = 100.04 \text{ g/mol}$$

The mer molecular weights of the polymers listed in Table 14.3 are as follows:

Polyethylene--28.05 g/mol

Polyvinyl chloride--62.49 g/mol  
 Polytetrafluoroethylene--100.02 g/mol  
 Polypropylene--42.08 g/mol  
 Polystyrene--104.14 g/mol  
 Polymethyl methacrylate--100.11 g/mol  
 Phenol-formaldehyde--133.16 g/mol  
 Nylon 6,6--226.32 g/mol  
 PET--192.16 g/mol  
 Polycarbonate--254.27 g/mol

Therefore, polytetrafluoroethylene is the material since its mer molecular weight is closest to that calculated above.

(d) The weight-average degree of polymerization may be calculated using Equation (14.4b), since  $\bar{M}_w$  and  $\bar{m}$  were computed in portions (b) and (c) of this problem. Thus

$$n_w = \frac{\bar{M}_w}{m} = \frac{53,720 \text{ g/mol}}{100.04 \text{ g/mol}} = 537$$

14.8 This problem asks if it is possible to have a polyvinyl chloride homopolymer with the given molecular weight data and a number-average degree of polymerization of 1120. The appropriate data are given below along with a computation of the number-average molecular weight.

Molecular wt. Range	Mean $M_i$	$x_i$	$x_i M_i$
8,000-20,000	14,000	0.05	700
20,000-32,000	26,000	0.15	3900
32,000-44,000	38,000	0.21	7980
44,000-56,000	50,000	0.28	14,000
56,000-68,000	62,000	0.18	11,160
68,000-80,000	74,000	0.10	7440
80,000-92,000	86,000	0.03	2580

---

$$\bar{M}_w = \sum x_i M_i = 47,720 \text{ g/mol}$$

For PVC, from Table 14.3, each mer unit has two carbons, three hydrogens, and one chlorine. Thus,

$$m = 2(A_C) + 3(A_H) + (A_{Cl})$$

$$= (2)(12.01 \text{ g/mol}) + (3)(1.008 \text{ g/mol}) + (35.45 \text{ g/mol}) = 62.49 \text{ g/mol}$$

Now, we will compute  $n_n$  from Equation (14.4a) as

$$n_n = \frac{\bar{M}_n}{m} = \frac{47,720 \text{ g/mol}}{62.49 \text{ g/mol}} = 764$$

Thus, such a homopolymer is **not possible** since the calculated  $n_n$  is 764 not 1120.

14.9 (a) For chlorinated polyethylene, we are asked to determine the weight percent of chlorine added for 5% Cl substitution of all original hydrogen atoms. Consider 50 carbon atoms; there are 100 possible side-bonding sites. Ninety-five are occupied by hydrogen and five are occupied by Cl. Thus, the mass of these 50 carbon atoms,  $m_C$ , is just

$$m_C = 50(A_C) = (50)(12.01 \text{ g/mol}) = 600.5 \text{ g}$$

Likewise, for hydrogen and chlorine,

$$m_H = 95(A_H) = (95)(1.008 \text{ g/mol}) = 95.76 \text{ g}$$

$$m_{Cl} = 5(A_{Cl}) = (5)(35.45 \text{ g/mol}) = 177.25 \text{ g}$$

Thus, the concentration of chlorine,  $C_{Cl}$ , is just

$$C_{Cl} = \frac{177.25 \text{ g}}{600.5 \text{ g} + 95.76 \text{ g} + 177.25 \text{ g}} \times 100 = 20.3 \text{ wt\%}$$

(b) Chlorinated polyethylene differs from polyvinyl chloride, in that, for PVC, 1) 25% of the side-bonding sites are substituted with Cl, and 2) the substitution is probably much less random.

14.10 Relative to polymer chains, the difference between **configuration** and **conformation** is that conformation is used in reference to the outline or shape of the chain molecule, whereas,

configuration refers to the arrangement of atom positions along the chain that are not alterable except by the breaking and reforming of primary bonds.

14.11 This problem first of all asks for us to calculate, using Equation (14.11), the average total chain length,  $L$ , for a linear polyethylene polymer having a number-average molecular weight of 300,000 g/mol. It is necessary to calculate the number-average degree of polymerization,  $n_n$ , using Equation (14.4a). For polyethylene, from Table 14.3, each mer unit has two carbons and four hydrogens. Thus,

$$m = 2(A_C) + 4(A_H)$$

$$= (2)(12.01 \text{ g/mol}) + (4)(1.008 \text{ g/mol}) = 28.05 \text{ g/mol}$$

and

$$n_n = \frac{\bar{M}_n}{m} = \frac{300,000 \text{ g/mol}}{28.05 \text{ g/mol}} = 10,695$$

which is the number of mer units along an average chain. Since there are two carbon atoms per mer unit, there are two C--C chain bonds per mer, which means that the total number of chain bonds in the molecule,  $N$ , is just  $(2)(10,695) = 21,390$  bonds. Furthermore, assume that for single carbon-carbon bonds,  $d = 0.154 \text{ nm}$  and  $\theta = 109^\circ$  (Section 14.4); therefore, from Equation (14.11)

$$L = Nd \sin\left(\frac{\theta}{2}\right)$$

$$= (21,390)(0.154 \text{ nm}) \left[ \sin\left(\frac{109^\circ}{2}\right) \right] = 2682 \text{ nm}$$

It is now possible to calculate the average chain end-to-end distance,  $r$ , using Equation (14.12) as

$$r = d\sqrt{N} = (0.154 \text{ nm})\sqrt{21,390} = 22.5 \text{ nm}$$

14.12 (a) This portion of the problem asks for us to calculate the number-average molecular weight for a linear polytetrafluoroethylene for which  $L$  in Equation (14.11) is 2000 nm. It is first necessary to compute the value of  $N$  using this equation, where, for the C--C chain bond,  $d = 0.154 \text{ nm}$ , and  $\theta = 109^\circ$ . Thus

$$N = \frac{L}{d \sin\left(\frac{\theta}{2}\right)}$$

$$= \frac{2000 \text{ nm}}{(0.154 \text{ nm}) \sin\left(\frac{109^\circ}{2}\right)} = 15,900$$

Since there are two C--C bonds per PTFE mer unit, there is an average of  $\mathbf{N}/2$  or  $15,900/2 = 7950$  mer units per chain, which is also the number-average degree of polymerization,  $n_n$ . In order to compute the value of  $\bar{M}_n$  using Equation (14.4a), we must first determine  $m$  for PTFE. Each PTFE mer unit consists of two carbon and four fluorine atoms, thus

$$m = 2(A_C) + 4(A_F)$$

$$= (2)(12.01 \text{ g/mol}) + (4)(19.00 \text{ g/mol}) = 100.02 \text{ g/mol}$$

Therefore

$$\bar{M}_n = n_n m = (7950)(100.02 \text{ g/mol}) = 795,000 \text{ g/mol}$$

(b) Next, we are to determine the number-average molecular weight for  $r = 15 \text{ nm}$ . Solving for  $\mathbf{N}$  from Equation (14.12) leads to

$$N = \frac{r^2}{d^2} = \frac{(15 \text{ nm})^2}{(0.154 \text{ nm})^2} = 9490$$

which is the total number of bonds per average molecule. Since there are two C--C bonds per mer unit, then  $n_n = \mathbf{N}/2 = 9490/2 = 4745$ . Now, from Equation (14.4a)

$$\bar{M}_n = n_n m = (4745)(100.02 \text{ g/mol}) = 474,600 \text{ g/mol}$$

14.13 We are asked to sketch portions of a linear polypropylene molecule for different configurations.

(a) Syndiotactic polypropylene

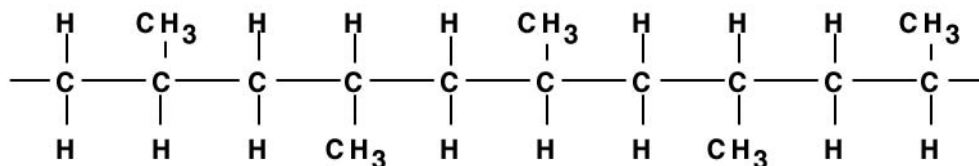

(b) Atactic polypropylene

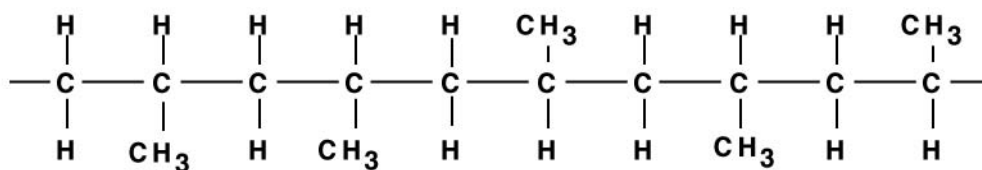

(c) Isotactic polypropylene

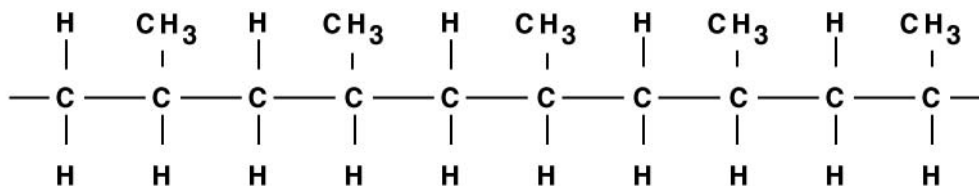

14.14 (a) The structure of **cis** polybutadiene is

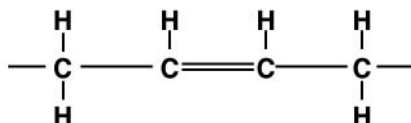

The structure of **trans** butadiene is

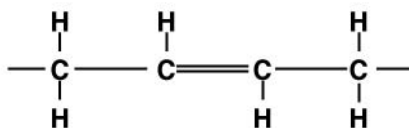

(b) The structure of **cis** chloroprene is

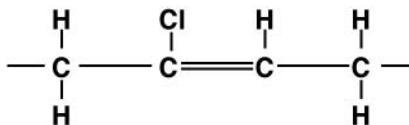

The structure of **trans** chloroprene is

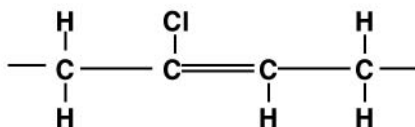

14.15 This question asks for comparisons of thermoplastic and thermosetting polymers.

(a) Thermoplastic polymers soften when heated and harden when cooled, whereas thermosetting polymers, harden upon heating, while further heating will not lead to softening.

(b) Thermoplastic polymers have linear and branched structures, while for thermosetting polymers, the structures will normally be network or crosslinked.

14.16 Thermosetting polyesters will be crosslinked, while thermoplastic ones will have linear structures without any appreciable crosslinking.

14.17 (a) It is not possible to grind up and reuse phenol-formaldehyde because it is a network thermoset polymer and, therefore, is not amenable to remolding.

(b) Yes, it is possible to grind up and reuse polypropylene since it is a thermoplastic polymer, will soften when reheated, and, thus, may be remolded.

14.18 This problem asks for sketches of the mer structures for several alternating copolymers.

(a) For poly(ethylene-propylene)

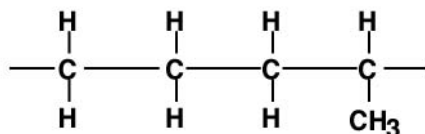

(b) For poly(butadiene-styrene)

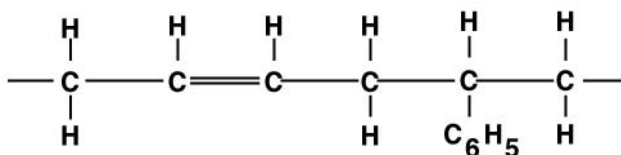

(c) For poly(isobutylene-isoprene)

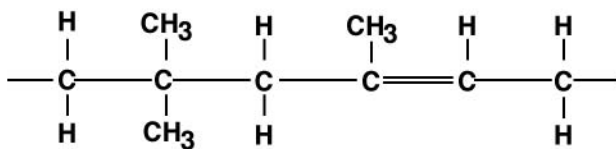

14.19 For a poly(styrene-butadiene) alternating copolymer with a number-average molecular weight of 1,350,000 g/mol, we are asked to determine the average number of styrene and butadiene mer units per molecule.

Since it is an alternating copolymer, the number of both types of mer units will be the same. Therefore, consider them as a single mer unit, and determine the number-average degree of polymerization. For the styrene mer, there are eight carbon atoms and eight hydrogen atoms, while the butadiene mer consists of four carbon atoms and six hydrogen atoms. Therefore, the styrene-butadiene combined mer weight is just

$$\begin{aligned} m &= 12(A_C) + 14(A_H) \\ &= (12)(12.01 \text{ g/mol}) + (14)(1.008 \text{ g/mol}) = 158.23 \text{ g/mol} \end{aligned}$$

From Equation (14.4a), the number-average degree of polymerization is just

$$n_n = \frac{\bar{M}_n}{m} = \frac{135,000 \text{ g/mol}}{158.23 \text{ g/mol}} = 8530$$

Thus, there is an average of 8530 of both mer types per molecule.

14.20 This problem asks for us to calculate the number-average molecular weight of a random nitrile rubber copolymer. For the acrylonitrile mer there are three carbon, one nitrogen, and three hydrogen atoms. Thus, its mer molecular weight is

$$\begin{aligned} m_{Ac} &= 3(A_C) + (A_N) + 3(A_H) \\ &= (3)(12.01 \text{ g/mol}) + 14.01 \text{ g/mol} + (3)(1.008 \text{ g/mol}) = 53.06 \text{ g/mol} \end{aligned}$$

The butadiene mer is composed of four carbon and six hydrogen atoms. Thus, its mer molecular weight is

$$\begin{aligned} m_{Bu} &= 4(A_C) + 6(A_H) \\ &= (4)(12.01 \text{ g/mol}) + (6)(1.008 \text{ g/mol}) = 54.09 \text{ g/mol} \end{aligned}$$

From Equation (14.5), the average mer molecular weight is just



$$\begin{aligned}\bar{m} &= f_{Ac}m_{Ac} + f_{Bu}m_{Bu} \\ &= (0.70)(53.06 \text{ g/mol}) + (0.30)(54.09 \text{ g/mol}) = 53.37 \text{ g/mol}\end{aligned}$$

Since  $n_n = 2000$  (as stated in the problem),  $\bar{M}_n$  may be computed using Equation (14.4a) as

$$\bar{M}_n = \bar{m}n_n = (53.37 \text{ g/mol})(2000) = 106,740 \text{ g/mol}$$

14.21 For an alternating copolymer that has a number-average molecular weight of 100,000 g/mol and a number-average degree of polymerization of 2210, we are to determine one of the mer types if the other is ethylene. It is first necessary to calculate  $\bar{m}$  using Equation (14.4a) as

$$\bar{m} = \frac{\bar{M}_n}{n_n} = \frac{100,000 \text{ g/mol}}{2210} = 45.25 \text{ g/mol}$$

Since this is an alternating copolymer we know that chain fraction of each mer type is 0.5; that is  $f_e = f_x = 0.5$ ,  $f_e$  and  $f_x$  being, respectively, the chain fractions of the ethylene and unknown mers. Also, the mer molecular weight for ethylene is

$$\begin{aligned}m_s &= 2(A_C) + 4(A_H) \\ &= 2(12.01 \text{ g/mol}) + 4(1.008 \text{ g/mol}) = 28.05 \text{ g/mol}\end{aligned}$$

Now, using Equation (14.5), it is possible to calculate the mer weight of the unknown mer type,  $m_x$ .

Thus

$$\begin{aligned}m_x &= \frac{\bar{m} - f_e m_e}{f_x} \\ &= \frac{45.25 \text{ g/mol} - (0.5)(28.05 \text{ g/mol})}{0.5} = 62.45 \text{ g/mol}\end{aligned}$$

Finally, it is necessary to calculate the mer molecular weights for each of the possible other mer types. These are calculated below:

$$\begin{aligned}
m_{\text{styrene}} &= 8(A_C) + 8(A_H) = 8(12.01 \text{ g/mol}) + 8(1.008 \text{ g/mol}) = 104.16 \text{ g/mol} \\
m_{\text{propylene}} &= 3(A_C) + 6(A_H) = 3(12.01 \text{ g/mol}) + 6(1.008 \text{ g/mol}) = 42.08 \text{ g/mol} \\
m_{\text{TFE}} &= 2(A_C) + 4(A_F) = 2(12.01 \text{ g/mol}) + 4(19.00 \text{ g/mol}) = 100.02 \text{ g/mol} \\
m_{\text{VC}} &= 2(A_C) + 3(A_H) + (A_{Cl}) = 2(12.01 \text{ g/mol}) + 3(1.008 \text{ g/mol}) + 35.45 \text{ g/mol} = 62.49 \text{ g/mol}
\end{aligned}$$

Therefore, vinyl chloride is the other mer type since its  $m$  value is almost the same as the calculated  $\bar{m}_x$ .

14.22 (a) This portion of the problem asks us to determine the ratio of butadiene to acrylonitrile mers in a copolymer having a weight-average molecular weight of 250,000 g/mol and a weight-average degree of polymerization of 4640. It first becomes necessary to calculate the average mer molecular weight of the copolymer,  $\bar{m}$ , using Equation (14.4b) as

$$\bar{m} = \frac{\bar{M}_w}{n_w} = \frac{250,000 \text{ g/mol}}{4640} = 53.88 \text{ g/mol}$$

If we designate  $f_b$  as the chain fraction of butadiene mers, since the copolymer consists of only two mer types, the chain fraction of acrylonitrile mers  $f_a$  is just  $1 - f_b$ . Now, Equation (14.5) for this copolymer may be written in the form

$$\bar{m} = f_b m_b + f_a m_a = f_b m_b + (1 - f_b) m_a$$

in which  $m_b$  and  $m_a$  are the mer molecular weights for butadiene and acrylonitrile, respectively.

These values are calculated as follows:

$$m_b = 4(A_C) + 6(A_H) = 4(12.01 \text{ g/mol}) + 6(1.008 \text{ g/mol}) = 54.09 \text{ g/mol}$$

$$\begin{aligned}
m_a &= 3(A_C) + 3(A_H) + (A_N) = 3(12.01 \text{ g/mol}) + 3(1.008 \text{ g/mol}) + (14.01 \text{ g/mol}) \\
&= 53.06 \text{ g/mol.}
\end{aligned}$$

Solving for  $f_b$  in the above expression yields

$$f_b = \frac{\bar{m} - m_a}{m_b - m_a} = \frac{53.88 \text{ g/mol} - 53.06 \text{ g/mol}}{54.09 \text{ g/mol} - 53.06 \text{ g/mol}} = 0.80$$

Furthermore,  $f_a = 1 - f_b = 1 - 0.80 = 0.20$ ; or the ratio is just

$$\frac{f_b}{f_a} = \frac{0.80}{0.20} = 4.0$$

(b) Of the possible copolymers, the only one for which there is a restriction on the ratio of mer types is alternating; the ratio must be 1:1. Therefore, on the basis of the result in part (a), the possibilities for this copolymer are random, graft, and block.

14.23 For a copolymer consisting of 60 wt% ethylene and 40 wt% propylene, we are asked to determine the fraction of both mer types.

In 100 g of this material, there are 60 g of ethylene and 40 g of propylene. The ethylene ( $C_2H_4$ ) molecular weight is

$$\begin{aligned} m(\text{ethylene}) &= 2(A_C) + 4(A_H) \\ &= (2)(12.01 \text{ g/mol}) + (4)(1.008 \text{ g/mol}) = 28.05 \text{ g/mol} \end{aligned}$$

The propylene ( $C_3H_6$ ) molecular weight is

$$\begin{aligned} m(\text{propylene}) &= 3(A_C) + 6(A_H) \\ &= (3)(12.01 \text{ g/mol}) + (6)(1.008 \text{ g/mol}) = 42.08 \text{ g/mol} \end{aligned}$$

Therefore, in 100 g of this material, there are

$$\frac{60 \text{ g}}{28.05 \text{ g/mol}} = 2.14 \text{ mol of ethylene}$$

and

$$\frac{40 \text{ g}}{42.08 \text{ g/mol}} = 0.95 \text{ mol of propylene}$$

Thus, the fraction of the ethylene mer,  $f(\text{ethylene})$ , is just

$$f(\text{ethylene}) = \frac{2.14 \text{ mol}}{2.14 \text{ mol} + 0.95 \text{ mol}} = 0.69$$

Likewise,

$$f(\text{propylene}) = \frac{0.95 \text{ mol}}{2.14 \text{ mol} + 0.95 \text{ mol}} = 0.31$$

14.24 For a random poly(isobutylene-isoprene) copolymer in which  $\bar{M}_w = 200,000 \text{ g/mol}$  and  $n_w = 3000$ , we are asked to compute the fractions of isobutylene and isoprene mers.

From Table 14.5, the isobutylene mer has four carbon and eight hydrogen atoms. Thus,

$$m_{ib} = (4)(12.01 \text{ g/mol}) + (8)(1.008 \text{ g/mol}) = 56.10 \text{ g/mol}$$

Also, from Table 14.5, the isoprene mer has five carbon and eight hydrogen atoms, and

$$m_{ip} = (5)(12.01 \text{ g/mol}) + (8)(1.008 \text{ g/mol}) = 68.11 \text{ g/mol}$$

From Equation (14.5)

$$\bar{m} = f_{ib}m_{ib} + f_{ip}m_{ip}$$

Now, let  $x = f_{ib}$ , such that

$$\bar{m} = 56.10x + (68.11)(1 - x)$$

since  $f_{ib} + f_{ip} = 1$ . Also, from Equation (14.4b)

$$n_w = \frac{\bar{M}_w}{\bar{m}}$$

Or

$$3000 = \frac{200,000 \text{ g/mol}}{[56.10x + 68.11(1 - x)] \text{ g/mol}}$$

Solving for  $x$  leads to  $x = f_{ib} = f(\text{isobutylene}) = 0.12$ . Also,

$$f(\text{isoprene}) = 1 - x = 1 - 0.12 = 0.88$$

- 14.25 (a) For crystalline metals, the individual atoms are positioned in a periodic or ordered arrangement over relatively large atomic distances. The long-range order in polymer crystals results from the packing of adjacent polymer chains.
- (b) For noncrystalline ceramic glasses, the atomic randomness exists outside the  $\text{SiO}_4^{4-}$  unit. The disorder in polymers results from chain misalignment.
- 14.26 The tendency of a polymer to crystallize decreases with increasing molecular weight because as the chains become longer it is more difficult for all regions along adjacent chains to align so as to produce the ordered atomic array.
- 14.27 For each of four pairs of polymers, we are asked to 1) state whether it is possible to decide which is more likely to crystallize; 2) if so, which is more likely and why; and 3) it is not possible to decide then why.
- (a) No, it is not possible to decide for these two polymers. On the basis of tacticity, the isotactic PP is more likely to crystallize than the atactic PVC. On the other hand, with regard to side-group bulkiness, the PVC is more likely to crystallize.
- (b) Yes, it is possible to decide for these two copolymers. The linear and syndiotactic polypropylene is more likely to crystallize than crosslinked cis-isoprene since linear polymers are more likely to crystallize than crosslinked ones.
- (c) Yes, it is possible to decide for these two polymers. The linear and isotactic polystyrene is more likely to crystallize than network phenol-formaldehyde; network polymers rarely crystallize, whereas isotactic ones crystallize relatively easily.
- (d) Yes, it is possible to decide for these two copolymers. The block poly(acrylonitrile-isoprene) copolymer is more likely to crystallize than the graft poly(chloroprene-isobutylene) copolymer. Block copolymers crystallize more easily than graft ones.
- 14.28 Given that polyethylene has an orthorhombic unit cell with two equivalent mer units, we are asked to compute the density of totally crystalline polyethylene. In order to solve this problem it is necessary to employ Equation (3.5), in which  $n$  represents the number of mer units within the unit cell ( $n = 2$ ), and  $A$  is the mer molecular weight, which for polyethylene is just

$$A = 2(A_C) + 4(A_H)$$

$$= (2)(12.01 \text{ g/mol}) + (4)(1.008 \text{ g/mol}) = 28.05 \text{ g/mol}$$

Also,  $V_C$  is the unit cell volume, which is just the product of the three unit cell edge lengths as shown in Figure 14.10. Thus,

$$\begin{aligned}\rho &= \frac{nA}{V_C N_A} \\ &= \frac{(2 \text{ mers/uc})(28.05 \text{ g/mol})}{\left[ (7.41 \times 10^{-8} \text{ cm})(4.94 \times 10^{-8} \text{ cm})(2.55 \times 10^{-8} \text{ cm}) \text{uc} \right] (6.023 \times 10^{23} \text{ mers/mol})} \\ &= 0.998 \text{ g/cm}^3\end{aligned}$$

14.29 For this problem we are given the density of nylon 6,6 ( $1.213 \text{ g/cm}^3$ ), an expression for the volume of its unit cell, and the lattice parameters, and are asked to determine the number of mer units per unit cell. This computation necessitates the use of Equation (3.5), in which we solve for  $n$ . Before this can be carried out we must first calculate  $V_C$ , the unit cell volume, and  $A$  the mer molecular weight. For  $V_C$

$$\begin{aligned}V_C &= abc\sqrt{1 - \cos^2 \alpha - \cos^2 \beta - \cos^2 \gamma + 2 \cos \alpha \cos \beta \cos \gamma} \\ &= (0.497)(0.547)(1.729)\sqrt{1 - 0.441 - 0.054 - 0.213 + 2(0.664)(0.232)(0.462)} \\ &= 0.3098 \text{ nm}^3 = 3.098 \times 10^{-22} \text{ cm}^3\end{aligned}$$

The mer unit for nylon 6,6 is shown in Table 14.3, from which the value of  $A$  may be determined as follows:

$$\begin{aligned}A &= 12(A_C) + 22(A_H) + 2(A_O) + 2(A_N) \\ &= 12(12.01 \text{ g/mol}) + 22(1.008 \text{ g/mol}) + 2(16.00 \text{ g/mol}) + 2(14.01 \text{ g/mol}) \\ &= 226.32 \text{ g/mol}\end{aligned}$$

Finally, solving for  $n$  from Equation (3.5) leads to

$$n = \frac{\rho V_C N_A}{A}$$

$$= \frac{(1.213 \text{ g/cm}^3)(3.098 \times 10^{-22} \text{ cm}^3/\text{unit cell})(6.023 \times 10^{23} \text{ mers/mol})}{226.32 \text{ g/mol}}$$

$$= 1 \text{ mer/unit cell}$$

14.30 (a) We are asked to compute the densities of totally crystalline and totally amorphous polyethylene [ $\rho_c$  and  $\rho_a$  from Equation (14.10)]. From Equation (14.10) let  $C = (\% \text{ crystallinity})/100$ , such that

$$C = \frac{\rho_c(\rho_s - \rho_a)}{\rho_s(\rho_c - \rho_a)}$$

Rearrangement of this expression leads to

$$\rho_c(C\rho_s - \rho_s) + \rho_c\rho_a - C\rho_s\rho_a = 0$$

in which  $\rho_c$  and  $\rho_a$  are the variables for which solutions are to be found. Since two values of  $\rho_s$  and  $C$  are specified in the problem, two equations may be constructed as follows:

$$\rho_c(C_1\rho_{s1} - \rho_{s1}) + \rho_c\rho_a - C_1\rho_{s1}\rho_a = 0$$

$$\rho_c(C_2\rho_{s2} - \rho_{s2}) + \rho_c\rho_a - C_2\rho_{s2}\rho_a = 0$$

In which  $\rho_{s1} = 0.965 \text{ g/cm}^3$ ,  $\rho_{s2} = 0.925 \text{ g/cm}^3$ ,  $C_1 = 0.768$ , and  $C_2 = 0.464$ . Solving the above two equations leads to

$$\rho_a = \frac{\rho_{s1}\rho_{s2}(C_1 - C_2)}{C_1\rho_{s1} - C_2\rho_{s2}}$$

$$= \frac{(0.965 \text{ g/cm}^3)(0.925 \text{ g/cm}^3)(0.768 - 0.464)}{(0.768)(0.965 \text{ g/cm}^3) - (0.464)(0.925 \text{ g/cm}^3)} = 0.870 \text{ g/cm}^3$$

And

$$\rho_c = \frac{\rho_{s1}\rho_{s2}(C_2 - C_1)}{\rho_{s2}(C_2 - 1) - \rho_{s1}(C_1 - 1)}$$

$$= \frac{(0.965 \text{ g/cm}^3)(0.925 \text{ g/cm}^3)(0.464 - 0.768)}{(0.925 \text{ g/cm}^3)(0.464 - 1.0) - (0.965 \text{ g/cm}^3)(0.768 - 1.0)} = 0.998 \text{ g/cm}^3$$

(b) Now we are to determine the % **crystallinity** for  $\rho_s = 0.950 \text{ g/cm}^3$ . Again, using Equation (14.10)

$$\% \text{ crystallinity} = \frac{\rho_c(\rho_s - \rho_a)}{\rho_s(\rho_c - \rho_a)} \times 100$$

$$= \frac{(0.998 \text{ g/cm}^3)(0.950 \text{ g/cm}^3 - 0.870 \text{ g/cm}^3)}{(0.950 \text{ g/cm}^3)(0.998 \text{ g/cm}^3 - 0.870 \text{ g/cm}^3)} \times 100$$

$$= 65.7\%$$

14.31 (a) We are asked to compute the densities of totally crystalline and totally amorphous polypropylene [ $\rho_c$  and  $\rho_a$  from Equation (14.10)]. From Equation (14.10) let  $C = \frac{\% \text{ crystallinity}}{100}$ , such that

$$C = \frac{\rho_c(\rho_s - \rho_a)}{\rho_s(\rho_c - \rho_a)}$$

Rearrangement of this expression leads to

$$\rho_c(C\rho_s - \rho_s) + \rho_c\rho_a - C\rho_s\rho_a = 0$$

in which  $\rho_c$  and  $\rho_a$  are the variables for which solutions are to be found. Since two values of  $\rho_s$  and  $C$  are specified in the problem, two equations may be constructed as follows:

$$\rho_c(C_1\rho_{s1} - \rho_{s1}) + \rho_c\rho_a - C_1\rho_{s1}\rho_a = 0$$



$$\rho_c(C_2\rho_{s2} - \rho_{s2}) + \rho_c\rho_a - C_2\rho_{s2}\rho_a = 0$$

In which  $\rho_{s1} = 0.904 \text{ g/cm}^3$ ,  $\rho_{s2} = 0.895 \text{ g/cm}^3$ ,  $C_1 = 0.628$ , and  $C_2 = 0.544$ . Solving the above two equations leads to

$$\begin{aligned} \rho_a &= \frac{\rho_{s1}\rho_{s2}(C_1 - C_2)}{C_1\rho_{s1} - C_2\rho_{s2}} \\ &= \frac{(0.904 \text{ g/cm}^3)(0.895 \text{ g/cm}^3)(0.628 - 0.544)}{(0.628)(0.904 \text{ g/cm}^3) - (0.544)(0.895 \text{ g/cm}^3)} = 0.841 \text{ g/cm}^3 \end{aligned}$$

And

$$\begin{aligned} \rho_c &= \frac{\rho_{s1}\rho_{s2}(C_2 - C_1)}{\rho_{s2}(C_2 - 1) - \rho_{s1}(C_1 - 1)} \\ &= \frac{(0.904 \text{ g/cm}^3)(0.895 \text{ g/cm}^3)(0.544 - 0.628)}{(0.895 \text{ g/cm}^3)(0.544 - 1.0) - (0.904 \text{ g/cm}^3)(0.628 - 1.0)} = 0.946 \text{ g/cm}^3 \end{aligned}$$

(b) Now we are asked to determine the density of a specimen having 74.6% crystallinity. Solving for  $\rho_s$  from Equation (14.10) and substitution for  $\rho_a$  and  $\rho_c$  which were computed in part (a) yields

$$\begin{aligned} \rho_s &= \frac{-\rho_c\rho_a}{C(\rho_c - \rho_a) - \rho_c} \\ &= \frac{-(0.946 \text{ g/cm}^3)(0.841 \text{ g/cm}^3)}{(0.746)(0.946 \text{ g/cm}^3 - 0.841 \text{ g/cm}^3) - 0.946 \text{ g/cm}^3} \\ &= 0.917 \text{ g/cm}^3 \end{aligned}$$

## CHAPTER 15

### CHARACTERISTICS, APPLICATIONS, AND PROCESSING OF POLYMERS

#### PROBLEM SOLUTIONS

15.1 From Figure 15.3, the elastic modulus is the slope in the elastic linear region of the 20°C curve, which is

$$E = \frac{\Delta(\text{stress})}{\Delta(\text{strain})} = \frac{30 \text{ MPa} - 0 \text{ MPa}}{9 \times 10^{-3} - 0} = 3.3 \text{ GPa} \quad (483,000 \text{ psi})$$

The value range cited in Table 15.1 is 2.24 to 3.24 GPa (325,000 to 470,000 psi). Thus, the plotted value is a little on the high side.

The tensile strength corresponds to the stress at which the curve ends, which is 52 MPa (7500 psi). This value lies within the range cited in the table--48.3 to 72.4 MPa (7,000 to 10,500 psi).

15.2 The reason that it is not necessary to specify specimen gauge length when citing percent elongation for semicrystalline polymers is because, for semicrystalline polymers that experience necking, the neck normally propagates along the entire gauge length prior to fracture; thus, there is no localized necking as with metals and the magnitude of the percent elongation is independent of gauge length.

15.3 The explanation of viscoelasticity is given in Section 15.4.

15.4 This problem asks for a determination of the relaxation modulus of a viscoelastic material, which behavior is according to Equation (15.10)--i.e.,

$$\sigma(t) = \sigma(0) \exp\left(-\frac{t}{\tau}\right)$$

We want to determine  $\sigma(10)$ , but it is first necessary to compute  $\tau$  from the data provided in the problem. Thus,

$$\tau = \frac{-t}{\ln\left[\frac{\sigma(t)}{\sigma(0)}\right]} = \frac{-30 \text{ s}}{\ln\left[\frac{0.5 \text{ MPa}}{3.5 \text{ MPa}}\right]} = 15.4 \text{ s}$$

Therefore,

$$\sigma(10) = (3.5 \text{ MPa}) \exp\left(-\frac{10 \text{ s}}{15.4 \text{ s}}\right) = 1.83 \text{ MPa}$$

Now, using Equation (15.1)

$$E_r(10) = \frac{\sigma(10)}{\varepsilon_0} = \frac{1.83 \text{ MPa}}{0.5} = 3.66 \text{ MPa} \quad (522 \text{ psi})$$

15.5 Below is plotted the logarithm of  $E_r(10)$  versus temperature.

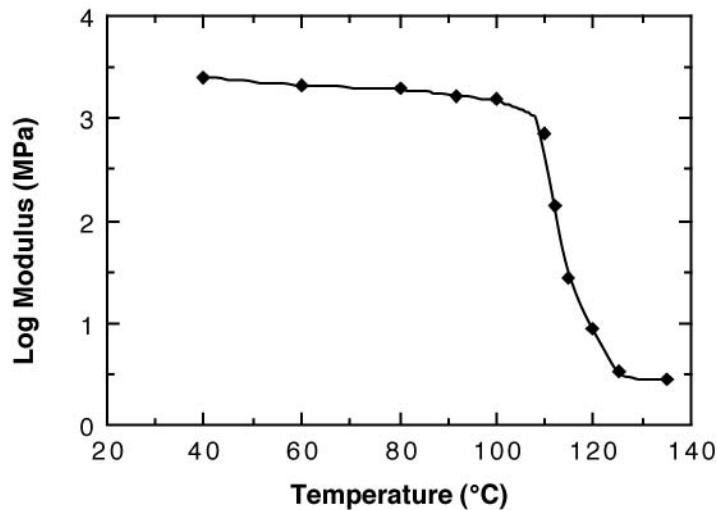

The glass-transition temperature is that temperature corresponding to the abrupt decrease in  $\log E_r(10)$ , which for this PMMA material is about 115°C.

15.6 We are asked to make schematic strain-time plots for various polystyrene materials and at several temperatures.

(a) Crystalline polystyrene at 70°C behaves in a glassy manner (Figure 15.8, curve **A**); therefore, the strain-time behavior would be as Figure 15.5(b).

(b) Amorphous polystyrene at 180°C behaves as a viscous liquid (Figure 15.8, curve **C**); therefore, the strain-time behavior will be as Figure 15.5(d).

(c) Crosslinked polystyrene at 180°C behaves as a rubbery material (Figure 15.8, curve **B**); therefore, the strain-time behavior will be as Figure 15.5(c).

(d) Amorphous polystyrene at 100°C behaves as a leathery material (Figure 15.7); therefore, the strain-time behavior will be as Figure 15.5(c).

15.7 (a) Stress relaxation tests are conducted by rapidly straining the material elastically in tension, holding the strain level constant, and then measuring the stress as a function of time. For viscoelastic creep tests, a stress (usually tensile) is applied instantaneously and maintained constant while strain is measured as a function of time.

(b) The experimental parameters of interest from the stress relaxation and viscoelastic creep tests are the relaxation modulus and creep modulus, respectively. The relaxation modulus is the ratio of stress measured after 10 s and strain [Equation (15.1)]; creep modulus is the ratio of stress and the strain taken at a specific time [Equation (15.2)].

15.8 (a) This portion of the problem calls for a plot of  $\log E_r(10)$  versus temperature demonstrating how the behavior changes with increased molecular weight. Such a plot is given below. Increasing molecular weight increases both glass-transition and melting temperatures.

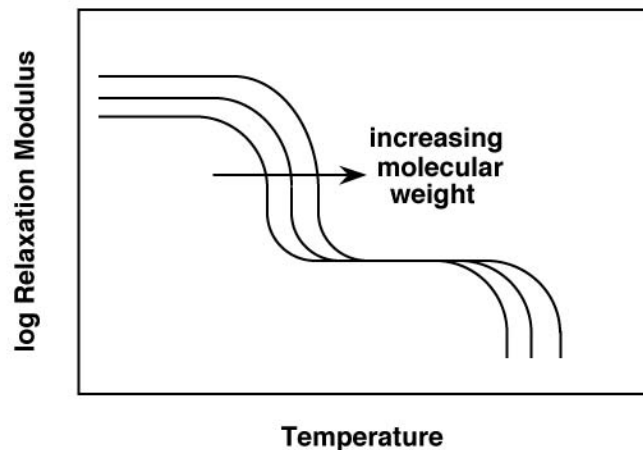

(b) We are now called upon to make a plot of  $\log E_r(10)$  versus temperature demonstrating how the behavior changes with increased crosslinking. Such a plot is given below. Increasing the degree of crosslinking will increase the modulus in both glassy and rubbery regions.

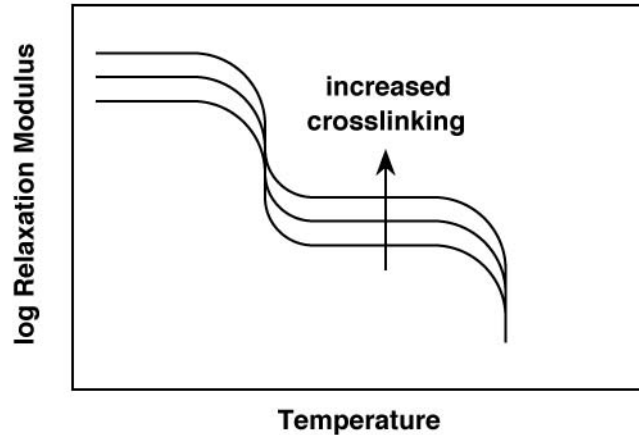

15.9 For thermoplastic polymers, five factors that favor brittle fracture are as follows: a reduction in temperature, an increase in strain rate, the presence of a sharp notch, increased specimen thickness, and modifications of the polymer structure.

15.10 (a) The fatigue limits for PMMA and the steel alloy are 19 MPa (2800 psi) and 290 MPa (42,200 psi), respectively.

(b) At  $10^6$  cycles, the fatigue strengths for nylon 6 and 2014-T6 aluminum are 22 MPa (3200 psi) and 200 MPa (30,000 psi), respectively.

15.11 (a) and (b) The mechanisms by which semicrystalline polymers elastically and plastically deform are described in Section 15.7.

(c) The explanation of the mechanism by which elastomers elastically deform is provided in Section 15.9.

15.12 (a) The tensile modulus is not directly influenced by a polymer's molecular weight.

(b) Tensile modulus increases with increasing degree of crystallinity for semicrystalline polymers. This is due to enhanced secondary interchain bonding which results from a greater degree of chain segment alignment as percent crystallinity increases. This enhanced interchain bonding inhibits relative interchain motion.

(c) Deformation by drawing also increases the tensile modulus. The reason for this is that drawing produces a highly oriented molecular structure, and a relatively high degree of interchain secondary bonding.

(d) When an undeformed semicrystalline polymer is annealed below its melting temperature, its tensile modulus increases.

(e) A drawn semicrystalline polymer that is annealed experiences a decrease in tensile modulus as a result of a reduction in chain-induced crystallinity, and a reduction in interchain bonding forces.

15.13 (a) The tensile or yield strength of a semicrystalline polymer increases with increasing molecular weight. This effect is explained by increased chain entanglements at higher molecular weights.

(b) Increasing the degree of crystallinity of a semicrystalline polymer leads to an enhancement of the tensile strength. Again, this is due to enhanced interchain bonding and forces; in response to applied stresses, interchain motions are thus inhibited.

(c) Deformation by drawing increases the tensile strength of a semicrystalline polymer. This effect is due to the highly oriented chain structure that is produced by drawing, which gives rise to higher interchain secondary bonding forces.

(d) Annealing an undeformed semicrystalline polymer produces an increase in its tensile strength.

15.14 Normal butane has a higher melting temperature as a result of its molecular structure (Section 14.2). There is more of an opportunity for van der Waals bonds to form between two molecules in close proximity to one another than for isobutane because of the linear nature of each normal butane molecule.

15.15 This problem gives us the tensile strengths and associated number-average molecular weights for two polymethyl methacrylate materials and then asks that we estimate the tensile strength for  $\bar{M}_n = 30,000$  g/mol. Equation (15.3) provides the dependence of the tensile strength on  $\bar{M}_n$ . Thus, using the data provided in the problem, we may set up two simultaneous equations from which it is possible to solve for the two constants  $TS_\infty$  and **A**.

These equations are as follows:

$$107 \text{ MPa} = TS_\infty - \frac{A}{40,000 \text{ g/mol}}$$

$$170 \text{ MPa} = TS_\infty - \frac{A}{60,000 \text{ g/mol}}$$

Thus, the values of the two constants are:  $TS_\infty = 296$  MPa and  $A = 7.56 \times 10^6$  MPa-g/mol. Substituting these values into the equation for which  $\bar{M}_n = 30,000$  g/mol leads to

$$\begin{aligned}
TS &= TS_{\infty} - \frac{A}{30,000 \text{ g/mol}} \\
&= 296 \text{ MPa} - \frac{7.56 \times 10^6 \text{ MPa} \cdot \text{g/mol}}{30,000 \text{ g/mol}} \\
&= 44 \text{ MPa}
\end{aligned}$$

15.16 This problem gives us the tensile strengths and associated number-average molecular weights for two polyethylene materials and then asks that we estimate the  $\bar{M}_n$  that is required for a tensile strength of 195 MPa. Equation (15.3) provides the dependence of the tensile strength on  $\bar{M}_n$ . Thus, using the data provided in the problem, we may set up two simultaneous equations from which it is possible to solve for the two constants  $TS_{\infty}$  and  $A$ .

These equations are as follows:

$$\begin{aligned}
85 \text{ MPa} &= TS_{\infty} - \frac{A}{12,700 \text{ g/mol}} \\
150 \text{ MPa} &= TS_{\infty} - \frac{A}{28,500 \text{ g/mol}}
\end{aligned}$$

Thus, the values of the two constants are:  $TS_{\infty} = 202 \text{ MPa}$  and  $A = 1.489 \times 10^6 \text{ MPa} \cdot \text{g/mol}$ . Solving for  $\bar{M}_n$  in Equation (15.3) and substituting  $TS = 195 \text{ MPa}$  as well as the above values for  $TS_{\infty}$  and  $A$  leads to

$$\begin{aligned}
\bar{M}_n &= \frac{A}{TS_{\infty} - TS} \\
&= \frac{1.489 \times 10^6 \text{ MPa} \cdot \text{g/mol}}{202 \text{ MPa} - 195 \text{ MPa}} = 213,000 \text{ g/mol}
\end{aligned}$$

15.17 For each of four pairs of polymers, we are to do the following: 1) determine whether or not it is possible to decide which has the higher tensile modulus; 2) if it is possible, then note which has the higher tensile modulus and then state the reasons for this choice; and 3) if it is not possible to decide, then state why.

(a) No, it is not possible. Both syndiotactic and isotactic polystyrene have a tendency to crystallize, and, therefore, we assume that they have approximately the same crystallinity.

Furthermore, since tensile modulus is virtually independent of molecular weight, we would expect both materials to have approximately the same modulus.

(b) Yes, it is possible. The linear and isotactic polyvinyl chloride will display a greater tensile modulus. Linear polymers are more likely to crystallize than branched ones. In addition, polymers having isotactic structures normally have higher degrees of crystallinity than those having atactic structures. Increasing a polymer's crystallinity leads to an increase in its tensile modulus. In addition, tensile modulus is independent of molecular weight--the atactic/branched material has the higher molecular weight.

(c) Yes, it is possible. The block styrene-butadiene copolymer with 10% of possible sites crosslinked will have the higher modulus. Block copolymers normally have higher degrees of crystallinity than random copolymers of the same material. A higher degree of crystallinity favors a larger modulus. In addition, the block copolymer also has a higher degree of crosslinking; increasing the amount of crosslinking also enhances the tensile modulus.

(d) No, it is not possible. Branched polyethylene will tend to have a low degree of crystallinity since branched polymers don't normally crystallize. The atactic polypropylene probably also has a relatively low degree of crystallinity; atactic structures also don't tend to crystallize, and polypropylene has a more complex mer structure than does polyethylene. Tensile modulus increases with degree of crystallinity, and it is not possible to determine which polymer is more crystalline. Furthermore, tensile modulus is independent of molecular weight.

15.18 For each of four pairs of polymers, we are to do the following: 1) determine whether or not it is possible to decide which has the higher tensile strength; 2) if it is possible, then note which has the higher tensile strength and then state the reasons for this choice; and 3) if it is not possible to decide, then state why.

(a) Yes, it is possible. The syndiotactic polystyrene has the higher tensile strength. Both syndiotactic and isotactic polymers tend to crystallize, and, therefore, we assume that both materials have approximately the same crystallinity. However, tensile modulus increases with increasing molecular weight, and the syndiotactic PS has the higher molecular weight (600,000 g/mol versus 500,000 g/mol for the isotactic material).

(b) Yes, it is possible. The linear and isotactic material will have the higher tensile strength. Both linearity and isotacticity favor a higher degree of crystallinity than do branching and atacticity; and tensile strength increases with increasing degree of crystallinity. Furthermore, the molecular weight of the linear/isotactic material is higher (100,000 g/mol versus 75,000 g/mol), and tensile strength increases with increasing molecular weight.



(c) No, it is not possible. Alternating copolymers tend to be more crystalline than graft copolymers, and tensile strength increases with degree of crystallinity. However, the graft material has a higher degree of crosslinking, and tensile strength increases with the percentage of crosslinks.

(d) Yes, it is possible. The network polyester will display a greater tensile strength. Relative chain motion is much more restricted than for the lightly branched polytetrafluoroethylene since there are many more of the strong covalent bonds for the network structure.

15.19 The strength of a polychlorotrifluoroethylene having the mer structure

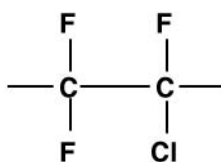

will be greater than for a polytetrafluoroethylene having the same molecular weight and degree of crystallinity. The replacement of one fluorine atom within the PTFE mer with a chlorine atom leads to a higher interchain attraction, and, thus, a stronger polymer. Furthermore, polyvinyl chloride is stronger than polyethylene (Table 15.1) for the same reason.

15.20 (a) Shown below are the stress-strain curves for the two polyisoprene materials, both of which have a molecular weight of 100,000 g/mol. These two materials are elastomers and will have curves similar to curve **C** in Figure 15.1. However, the curve for the material having the greater number of crosslinks (20%) will have a higher elastic modulus at all strains.

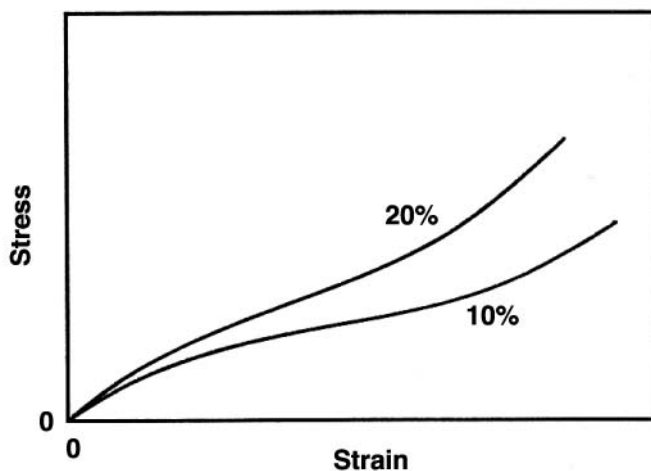

(b) Shown below are the stress-strain curves for the two polypropylene materials. These materials will most probably display the stress-strain behavior of a normal plastic, curve **B** in Figure 15.1. However, the syndiotactic polypropylene has a higher molecular weight and will also undoubtedly have a higher degree of crystallinity; therefore, it will have a higher strength.

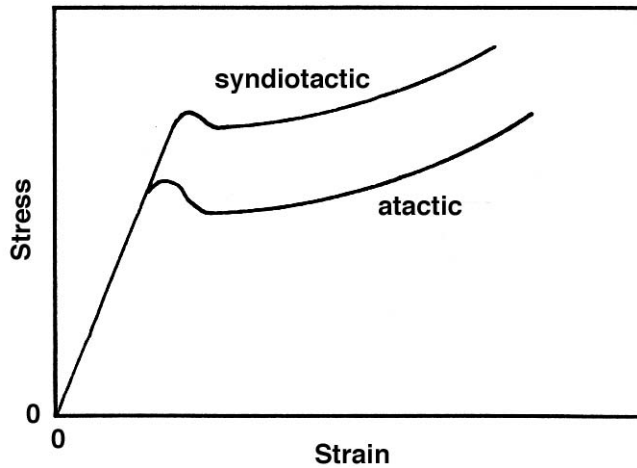

(c) Shown below are the stress-strain curves for the two polyethylene materials. The branched polyethylene will display the behavior of a normal plastic, curve **B** in Figure 15.1. On the other hand, the heavily crosslinked polyethylene will be stiffer, stronger, and more brittle (curve **A** of Figure 15.1).

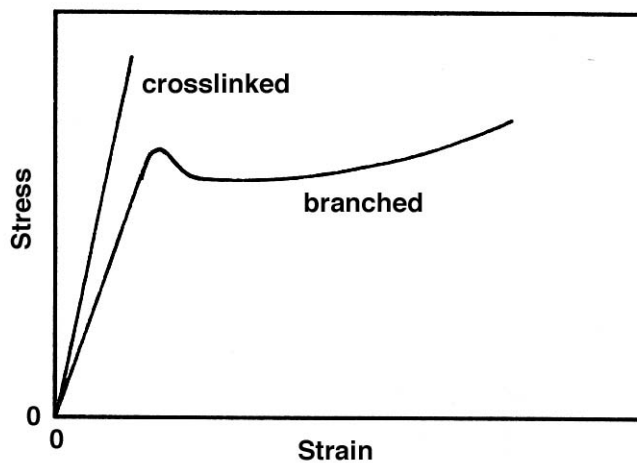

15.21 Two molecular characteristics essential for elastomers are: 1) they must be amorphous, having chains that are extensively coiled and kinked in the unstressed state; and 2) there must be some crosslinking.

15.22 This question asks us to choose from a list of materials those which would be expected to be elastomers and those which would be thermosetting polymers.

(a) Linear and crystalline polyethylene would be neither an elastomer nor a thermoset since it is a linear polymer.

(b) Phenol-formaldehyde having a network structure would be a thermosetting polymer since it has a network structure. It would not be an elastomer since it does not have a crosslinked chain structure.

(c) Heavily crosslinked polyisoprene having a glass transition temperature of 50°C would be a thermosetting polymer because it is heavily crosslinked. It would not be an elastomer since it is heavily crosslinked and room temperature is below its  $T_g$ .

(d) Lightly crosslinked polyisoprene having a glass transition temperature of -60°C is both an elastomer and a thermoset. It is an elastomer because it is lightly crosslinked and has a  $T_g$  below room temperature. It is a thermoset because it is crosslinked.

(e) Linear and partially amorphous polyvinyl chloride is neither an elastomer nor a thermoset. In order to be either it must have some crosslinking.

15.23 The molecules in elastomers must be two-dimensional chains that are lightly crosslinked and capable of being twisted and kinked in the unstressed state. Phenol-formaldehyde has a rigid three-dimensional structure consisting of trifunctional mer units, which does not meet these criteria for chain conformation and flexibility.

15.24 This problem asks that we compute the fraction of possible crosslink sites in 10 kg of polybutadiene when 4.8 kg of S is added, assuming that, on the average, 4.5 sulfur atoms participate in each crosslink bond. Given the butadiene mer unit in Table 14.5, we may calculate its molecular weight as follows:

$$\begin{aligned} A(\text{butadiene}) &= 4(A_C) + 6(A_H) \\ &= (4)(12.01 \text{ g/mol}) + 6(1.008 \text{ g/mol}) = 54.09 \text{ g/mol} \end{aligned}$$

Which means that in 10 kg of butadiene there are  $\frac{10,000 \text{ g}}{54.09 \text{ g/mol}} = 184.9 \text{ mol}$ .

For the vulcanization of polybutadiene, there are two possible crosslink sites per mer--one for each of the two carbon atoms that are doubly bonded. Furthermore, each of these crosslinks forms a bridge between two mers. Therefore, we can say that there is the equivalent of one crosslink per mer. Therefore, let us now calculate the number of moles of sulfur ( $n_{\text{sulfur}}$ ) that react with the butadiene, by taking the mole ratio of sulfur to butadiene, and then dividing this ratio by 4.5 atoms per crosslink; this yields the fraction of possible sites that are crosslinked. Thus

$$n_{\text{sulfur}} = \frac{4800 \text{ g}}{32.06 \text{ g/mol}} = 149.7 \text{ mol}$$

And

$$\text{fraction sites crosslinked} = \frac{\frac{149.7 \text{ mol}}{4.5}}{184.9 \text{ mol}} = 0.180$$

15.25 For an alternating chloroprene-acrylonitrile copolymer, we are asked to compute the weight percent sulfur necessary for complete crosslinking, assuming that, on the average, five sulfur atoms participate in each crosslink. The chloroprene and acrylonitrile mers are shown in Table 14.5, from which it may be noted that there are two possible crosslink sites on each chloroprene mer (one site at each of the two carbon atoms that are doubly bonded), and no possible crosslink sites for acrylonitrile; also, since it is an alternating copolymer, the ratio of chloroprene to acrylonitrile mers is 1:1. Thus, for each pair of combined chloroprene-acrylonitrile mers which crosslink, ten sulfur atoms are required, or, for complete crosslinking, the sulfur-to-(chloroprene-acrylonitrile) ratio is 5:1.

Now, let us consider as our basis, one mole of the combined chloroprene-acrylonitrile mer. In order for complete crosslinking, five moles of sulfur are required. Thus, for us to convert this composition to weight percent, it is necessary to convert moles to mass. The acrylonitrile mer consists of three carbon atoms, three hydrogen atoms, and one nitrogen atom; the chloroprene mer is composed of four carbons, five hydrogens, and one chlorine. This gives a molecular weight for the combined mer of

$$\begin{aligned} m(\text{chloroprene-acrylonitrile}) &= 3(A_C) + 3(A_H) + A_N + 4(A_C) + 5(A_H) + A_{Cl} \\ &= 7(12.01 \text{ g/mol}) + 8(1.008 \text{ g/mol}) + 14.007 \text{ g/mol} + 35.45 \text{ g/mol} = 141.59 \text{ g/mol} \end{aligned}$$

Or, in one mole of this combined mer, there are 141.59 g. Furthermore, for complete crosslinking, 5.0 mol of sulfur is required, which amounts to (5.0 mol)(32.06 g/mol) = 160.3 g. Thus, the concentration of S in weight percent  $C_S$  is just

$$C_S = \frac{160.3 \text{ g}}{160.3 \text{ g} + 141.59 \text{ g}} \times 100 = 53.1 \text{ wt\%}$$

15.26 This problem asks for us to determine how many crosslinks form per isoprene mer when 57 wt% sulfur is added. If we arbitrarily consider 100 g of the vulcanized material, 57 g will be sulfur and 43 g will be polyisoprene. Next, let us find how many moles of sulfur and isoprene correspond to these masses. The atomic weight of sulfur is 32.06 g/mol, and thus,

$$\# \text{ moles S} = \frac{57 \text{ g}}{32.06 \text{ g/mol}} = 1.78 \text{ mol}$$

However, there are 6 sulfur atoms in each crosslink, which requires us to divide the number of moles of sulfur by 6 in order to get the number of moles of sulfur per crosslink, which is equal to 0.297 moles.

Now, in each isoprene mer unit there are five carbon atoms and eight hydrogen atoms. Thus, the molecular weight of a mole of isoprene units is

$$(5)(12.01 \text{ g/mol}) + (8)(1.008 \text{ g/mol}) = 68.11 \text{ g/mol}$$

Or, in 43 g of polyisoprene

$$\# \text{ moles isoprene} = \frac{43 \text{ g}}{68.11 \text{ g/mol}} = 0.631 \text{ mol}$$

Therefore, the ratio of moles of S per crosslink to the number of moles of polyisoprene is

$$\frac{1.78 \text{ mol}}{0.631 \text{ mol}} : 1 = 2.82 : 1$$

When all possible sites are crosslinked, the ratio of the number of moles of sulfur to the number of moles of isoprene is 6:1, since there are two crosslink sites per mer unit and each crosslink is shared between mers on adjacent chains, and there are 6 sulfur atoms per crosslink. Finally, to determine the fraction of sites that are crosslinked, we just divide the actual crosslinked sulfur/isoprene ratio by the completely crosslinked ratio. Or,

$$\text{fraction of mer sites crosslinked} = \frac{2.82/1}{6/1} = 0.47$$

15.27 We are asked what weight percent of sulfur must be added to polyisoprene in order to ensure that 8% of possible sites are crosslinked, assuming that, on the average, three sulfur atoms are associated with each crosslink. Table 14.5 shows the chemical repeat unit for cis-isoprene. For each of these units there are two possible crosslink sites; one site is associated with each of the two carbon atoms that are involved in the chain double bond. Since 8% of the possible sites are crosslinked, for each 100 isoprene mers 8 of them are crosslinked; actually there are two crosslink sites per mer, but each crosslink is shared by two chains. Furthermore, on the average we assume that each crosslink is composed of 3 sulfur atoms; thus, there must be  $3 \times 8$  or 24 sulfur atoms added for every 100 isoprene mers. In terms of moles, it is necessary to add 24 moles of sulfur to 100 moles of isoprene. The atomic weight of sulfur is 32.06 g/mol, while the molecular weight of isoprene is

$$5(A_C) + 8(A_H)$$

$$= (5)(12.01 \text{ g/mol}) + (8)(1.008 \text{ g/mol}) = 68.11 \text{ g/mol}$$

The mass of sulfur added ( $m_S$ ) is

$$m_S = (24 \text{ mol})(32.06 \text{ g/mol}) = 769.4 \text{ g}$$

While for isoprene

$$m_{ip} = (100 \text{ mol})(68.11 \text{ g/mol}) = 6811 \text{ g}$$

Or, the concentration of sulfur in weight percent is just

$$C_S = \frac{769.4 \text{ g}}{769.4 \text{ g} + 6811 \text{ g}} \times 100 = 10.2 \text{ wt\%}$$

15.28 The reaction by which a chloroprene rubber may become vulcanized is as follows:

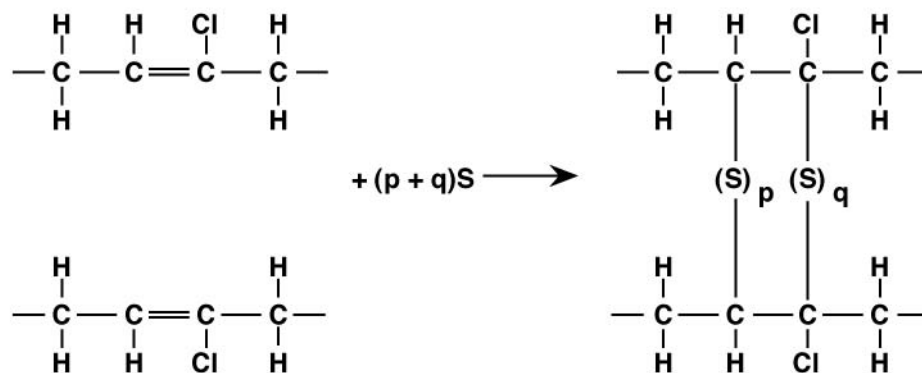

15.29 (a) Shown below are specific volume-versus-temperature curves for the two polyethylene materials. The linear polyethylene will be highly crystalline, and, therefore, will exhibit behavior similar to curve **C** in Figure 15.17. The branched polyethylene will be semicrystalline, and, therefore its curve will appear as curve **B** in this same figure. Furthermore, since the linear polyethylene has the greater molecular weight, it will also have the higher melting temperature.

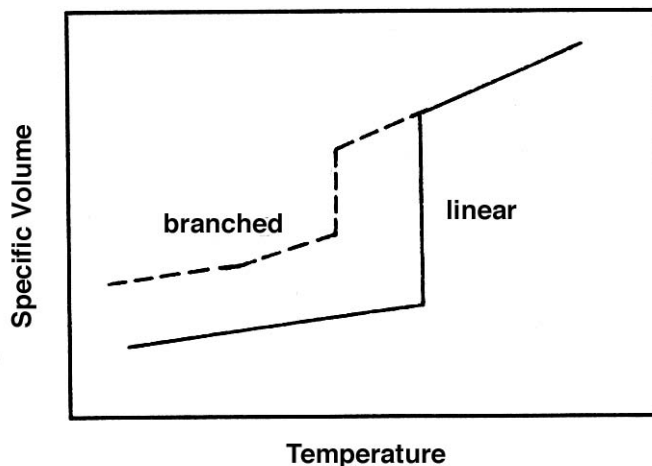

(b) Shown below are specific volume-versus-temperature curves for the polyvinyl chloride and polypropylene materials. Since both are 50% crystalline, they will exhibit behavior similar to curve **B** in Figure 15.17. However, since the polypropylene has the greater molecular weight it will have the higher melting temperature. Furthermore, polypropylene will also have the higher glass-transition temperature inasmuch as its  $\text{CH}_3$  side group is bulkier than the Cl for PVC.

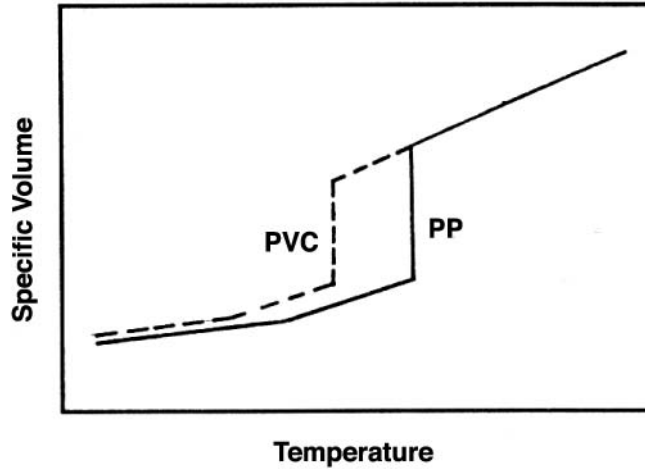

(c) Shown below are specific volume-versus-temperature curves for the polystyrene and polypropylene materials. Since both are totally amorphous, they will exhibit the behavior similar to curve A in Figure 15.17. However, since the polystyrene mer has a bulkier side group than polypropylene (Table 14.3), its chain flexibility will be lower, and, thus, its glass-transition temperature will be higher.

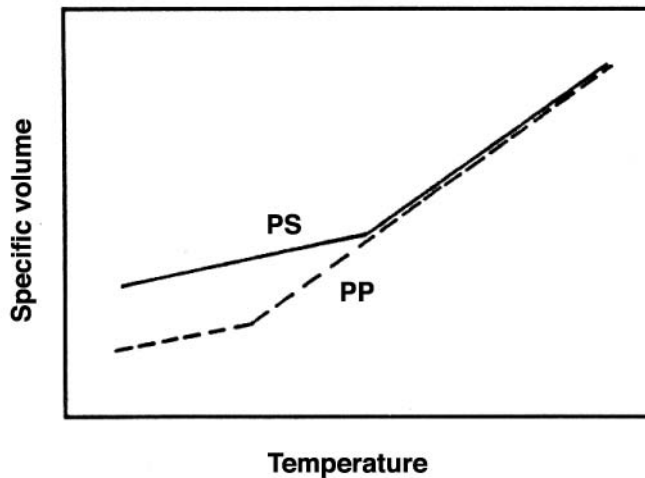

15.30 (a) Yes, it is possible to determine which polymer has the higher melting temperature. The linear polyethylene will most likely have a higher percent crystallinity, and, therefore, a higher melting temperature than the branched polyethylene. The molecular weights of both materials are the same and, thus, molecular weight is not a consideration.

(b) Yes, it is possible to determine which polymer has the higher melting temperature. Of these two polytetrafluoroethylene polymers, the PTFE with the higher density ( $2.20 \text{ g/cm}^3$ )



will have the higher percent crystallinity, and, therefore, a higher melting temperature than the lower density PTFE. The molecular weights of both materials are the same and, thus, molecular weight is not a consideration.

(c) Yes, it is possible to determine which polymer has the higher melting temperature. The linear polyethylene will have the greater melting temperature inasmuch as it will have a higher degree of crystallinity; polymers having a syndiotactic structure do not crystallize as easily as those polymers having identical single-atom side groups. With regard to molecular weight, or rather, the number-average degree of polymerization, it is about the same for both materials (8000), and therefore, is not a consideration.

(d) No, it is not possible to determine which of the two polymers has the higher melting temperature. The syndiotactic polypropylene will have a higher degree of crystallinity than the atactic material. On the basis of this effect alone, the syndiotactic PP should have the greater  $T_m$ , since melting temperature increases with degree of crystallinity. However, the molecular weight for the syndiotactic polypropylene (500,000 g/mol) is less than for the atactic material (750,000 g/mol); and this factor leads to a lowering of the melting temperature

15.31 For an amorphous polymer, the elastic modulus may be enhanced by increasing the number of crosslinks (while maintaining the molecular weight constant); this will also enhance the glass transition temperature. Thus, the modulus-glass transition temperature behavior would appear as

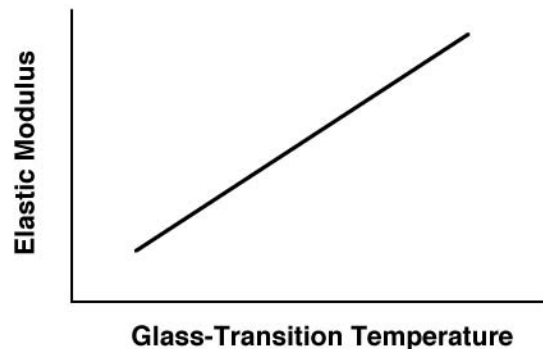

15.32 In this problem we are asked to determine the values of the constants  $n$  and  $k$  [Equation (10.1)] for the crystallization of polypropylene at 150°C (Figure 15.16). One way to solve this problem is to take two values of percent recrystallization [which is just  $100y$ , Equation (10.1)] and their corresponding time values, then set up two simultaneous equations, from which  $n$

and  $k$  may be determined. In order to expedite this process, we will rearrange and do some algebraic manipulation of Equation (10.1). First of all, we rearrange as follows:

$$1 - y = \exp(-kt^n)$$

Now taking natural logarithms

$$\ln(1 - y) = -kt^n$$

Or

$$-\ln(1 - y) = kt^n$$

which may also be expressed as

$$\ln\left(\frac{1}{1 - y}\right) = kt^n$$

Now taking natural logarithms again, leads to

$$\ln\left[\ln\left(\frac{1}{1 - y}\right)\right] = \ln k + n \ln t$$

which is the form of the equation that we will now use. From the 150°C curve of Figure 15.16, let us arbitrarily choose two percent crystallized values of 20% and 80% (i.e.,  $y_1 = 0.20$  and  $y_2 = 0.80$ ). Their corresponding time values are  $t_1 = 220$  min and  $t_2 = 460$  min (realizing that the time axis is scaled logarithmically). Thus, our two simultaneous equations become

$$\ln\left[\ln\left(\frac{1}{1 - 0.2}\right)\right] = \ln k + n \ln(220)$$

$$\ln\left[\ln\left(\frac{1}{1 - 0.8}\right)\right] = \ln k + n \ln(460)$$

from which we obtain the values  $n = 2.68$  and  $k = 1.2 \times 10^{-7}$ .

- 15.33 This question asks us to name which, of several polymers, would be suitable for the fabrication of cups to contain hot coffee. At its glass transition temperature, an amorphous polymer begins to soften. The maximum temperature of hot coffee is probably slightly below 100°C (212°F). Of the polymers listed, only polystyrene and polycarbonate have glass transition temperatures of 100°C or above (Table 15.2), and would be suitable for this application.
- 15.34 In order for a polymer to be suited for use as an ice cube tray it must have a glass-transition temperature below 0°C. Of those polymers listed in Table 15.2 only low-density and high-density polyethylene, PTFE, and polypropylene satisfy this criterion.
- 15.35 This question asks for us to determine which of several elastomers are suitable for automobile tires in Alaska. From Table 15.4, only natural polyisoprene, poly(styrene-butadiene), and polysiloxane have useful temperature ranges that extend to below -55°C. At temperatures below the lower useful temperature range limit, the other elastomers listed in this table become brittle, and, therefore, are not suitable for automobile tires.
- 15.36 The backbone chain of most polymers consists of carbon atoms that are linked together. For the silicone polymers, this backbone chain is composed of silicon and oxygen atoms that alternate positions.
- 15.37 The liquid silicones will have low molecular weights and very little crosslinking, whereas the molecular weights for the elastomers will be much higher; the elastomers will also have some crosslinking.
- 15.38 Two important characteristics for polymers that are to be used in fiber applications are: 1) a high molecular weight, and 2) a chain configuration/structure that allows for a high degree of crystallinity.
- 15.39 Five important characteristics for polymers that are to be used in thin film applications are: 1) low density; 2) high flexibility; 3) high tensile and tear strengths; 4) resistance to moisture/chemical attack; and 5) low gas permeability.
- 15.40 For addition polymerization, the reactant species have the same chemical composition as the monomer species in the molecular chain. This is not the case for condensation

polymerization, wherein there is a chemical reaction between two or more monomer species, producing the repeating mer unit. There is often a low molecular weight by-product for condensation polymerization; such is not found for addition polymerization.

15.41 In this question we are asked to cite whether the molecular weight of a polymer that is synthesized by addition polymerization is relatively high, medium, or low for four situations.

(a) For rapid initiation, slow propagation, and rapid termination the molecular weight will be relatively low.

(b) For slow initiation, rapid propagation, and slow termination the molecular weight will be relatively high.

(c) For rapid initiation, rapid propagation, and slow termination a medium molecular weight will be achieved.

(d) For slow initiation, slow propagation, and rapid termination the molecular weight will be low or medium.

15.42 (a) This problem asks that we determine how much ethylene glycol must be added to 20.0 kg of adipic acid to produce a linear chain structure of polyester according to Equation 15.9. Since the chemical formulas are provided in this equation we may calculate the molecular weights of each of these materials as follows:

$$A(\text{adipic}) = 6(A_C) + 10(A_H) + 4(A_O)$$

$$= 6(12.01 \text{ g/mol}) + 10(1.008 \text{ g/mol}) + 4(16.00 \text{ g/mol}) = 146.14 \text{ g/mol}$$

$$A(\text{glycol}) = 2(A_C) + 6(A_H) + 2(A_O)$$

$$= 2(12.01 \text{ g/mol}) + 6(1.008 \text{ g/mol}) + 2(16.00 \text{ g/mol}) = 62.07 \text{ g/mol}$$

The 20.0 kg mass of adipic acid equals 20,000 g or  $\frac{20,000 \text{ g}}{146.14 \text{ g/mol}} = 136.86 \text{ mol}$ . Since,

according to Equation (15.9), each mole of adipic acid used requires one mole of ethylene glycol, which is equivalent to  $(136.86 \text{ mol})(62.07 \text{ g/mol}) = 8495 \text{ g} = 8.495 \text{ kg}$ .

(b) Now we are asked for the mass of the resulting polyester. Inasmuch as one mole of water is given off for every mer unit produced, this corresponds to 136.86 moles or  $(136.86 \text{ mol})(18.02 \text{ g/mol}) = 2466 \text{ g}$  or 2.466 kg since the molecular weight of water is 18.02 g/mol.

The mass of polyester is just the sum of the masses of the two reactant materials [as computed in part (a)] minus the mass of water released, or

$$\text{mass}(\text{polyester}) = 20.0 \text{ kg} + 8.495 \text{ kg} - 2.466 \text{ kg} = 26.03 \text{ kg}$$

15.43 The following represents the reaction between hexamethylene diamine and adipic acid to produce nylon 6,6 with water as a by-product.

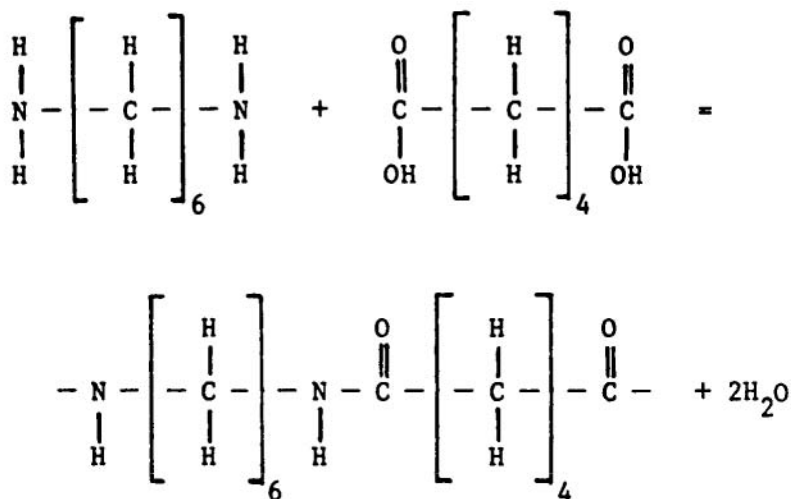

15.44 This problem asks for us to calculate the masses of hexamethylene diamine and adipic acid necessary to yield 20 kg of completely linear nylon 6,6. Let us first calculate the molecular weights of these molecules. (The chemical formula for hexamethylene diamine is given in Problem 15.43)

$$\begin{aligned}
 A(\text{adipic}) &= 6(A_{\text{C}}) + 10(A_{\text{H}}) + 4(A_{\text{O}}) \\
 &= 6(12.01 \text{ g/mol}) + 10(1.008 \text{ g/mol}) + 4(16.00 \text{ g/mol}) = 146.14 \text{ g/mol} \\
 A(\text{hexamethylene}) &= 6(A_{\text{C}}) + 16(A_{\text{H}}) + 2(A_{\text{N}}) \\
 &= 6(12.01 \text{ g/mol}) + 16(1.008 \text{ g/mol}) + 2(14.01 \text{ g/mol}) = 116.21 \text{ g/mol} \\
 A(\text{nylon}) &= 12(A_{\text{C}}) + 22(A_{\text{H}}) + 2(A_{\text{N}}) + 2(A_{\text{O}}) \\
 &= 12(12.01 \text{ g/mol}) + 22(1.008 \text{ g/mol}) + 2(14.01 \text{ g/mol}) + 2(16.00 \text{ g/mol})
 \end{aligned}$$

$$= 226.32 \text{ g/mol}$$

The mass of 20 kg of nylon 6,6 equals 20,000 g or

$$m(\text{nylon}) = \frac{20,000 \text{ g}}{226.32 \text{ g/mol}} = 88.37 \text{ mol}$$

Since, according to the chemical equation in Problem 15.43, each mole of nylon 6,6 that is produced requires one mole each of adipic acid and hexamethylene diamine, with two moles of water as the by-product. The masses corresponding to 88.37 moles of adipic acid and hexamethylene diamine are as follows:

$$m(\text{adipic}) = (88.37 \text{ mol})(146.14 \text{ g/mol}) = 12,914 \text{ g} = 12.914 \text{ kg}$$

$$m(\text{hexamethylene}) = (88.37 \text{ mol})(116.21 \text{ g/mol}) = 10,269 \text{ g} = 10.269 \text{ kg}$$

- 15.45 (a) If the vapor pressure of a plasticizer is not relatively low, the plasticizer may vaporize, which will result in an embrittlement of the polymer.
- (b) The crystallinity of a polymer to which has been added a plasticizer will be diminished, inasmuch as the plasticizer molecules fit in between the polymer molecules, which will cause more misalignment of the latter.
- (c) It would be difficult for a crosslinked polymer to be plasticized since the plasticizer molecules must fit between the chain molecules. This necessarily forces apart adjacent molecules, which the crosslinked bonds between the chains will resist.
- (d) The tensile strength of a polymer will be diminished when a plasticizer is added. As the plasticizer molecules force the polymer chain molecules apart, the magnitude of the secondary interchain bonds are lessened, which weakens the material since strength is a function of the magnitude of these bonds.

15.46 The distinction between dye and pigment colorants is that a dye dissolves within and becomes a part of the polymer structure, whereas a pigment does not dissolve, but remains as a separate phase.

15.47 Four factors that determine which fabrication technique is used to form polymeric materials are: 1) whether the polymer is thermoplastic or thermosetting; 2) if thermoplastic, the

softening temperature; 3) atmospheric stability; and 4) the geometry and size of the finished product.

15.48 This question requests that we compare polymer molding techniques. For compression molding, both heat and pressure are applied after the polymer and necessary additives are situated between the mold members. For transfer molding, the solid materials (normally thermosetting in nature) are first melted in the transfer chamber prior to being forced into the die. And, for injection molding (normally used for thermoplastic materials), the raw materials are impelled by a ram through a heating chamber, and finally into the die cavity.

15.49 Vulcanization of a rubber component should be carried out prior to the forming operation since, once it has been vulcanized, plastic deformation (and thus forming) is not possible since chain crosslinks have been introduced.

15.50 Fiber materials that are melt spun must be thermoplastic because: 1) In order to be melt spun, they must be capable of forming a viscous liquid when heated, which is not possible for thermosets. 2) During drawing, mechanical elongation must be possible; inasmuch as thermosetting materials are, in general, hard and relatively brittle, they are not easily elongated.

15.51 Of the two polymers cited, the one that was formed by extrusion and then rolled would have the higher strength. Both blown and extruded materials would have roughly comparable strengths; however the rolling operation would further serve to enhance the strength of the extruded material.

### Design Problems

15.D1 (a) Several advantages of using transparent polymeric materials for eyeglass lenses are: they have relatively low densities, and, therefore, are light in weight; they are relatively easy to grind to desired contours; they are less likely to shatter than are glass lenses; wrap-around lenses for protection during sports activities are possible; and they filter out more ultraviolet radiation than do glass lenses.

The principal disadvantage of these types of lenses is that some are relatively soft and are easily scratched (although antiscratch coatings may be applied). Plastic lenses are not as mechanically stable as glass, and, therefore, are not as precise optically.

(b) Some of the properties that are important for polymer lens materials are: they should be relatively hard in order to resist scratching; they must be impact resistant; they should be shatter resistant; they must have a relatively high index of refraction such that thin lenses may be ground for very nearsighted people; and they should absorb significant proportions of all types of ultraviolet radiation, which radiation can do damage to the eye tissues.

(c) Of those polymers discussed in this chapter and Chapter 14, ones that might appear to be likely lens candidates are polystyrene, polymethyl methacrylate, and polycarbonate; these three materials are not easily crystallized, and, therefore, are normally transparent. Upon consultation of their fracture toughnesses (Table B.5 in Appendix B), polycarbonate is the most superior of the three.

Commercially, the two plastic lens materials of choice are polycarbonate and allyl diglycol carbonate (having the trade name CR-39). Polycarbonate is very impact resistant, but not as hard as CR-39. Furthermore, PC comes in both normal and high refractive-index grades.

15.D2 There are three primary requirements for polymeric materials that are utilized in the packaging of food products and drinks; these are: 1) sufficient strength, to include tensile, tear, and impact strengths; 2) provide barrier protection--that is, be resistant to permeation by oxygen, water vapor, and carbon dioxide; and 3) be nonreactive with the food/drink contents--such reactions can compromise the integrity of the packaging material, or they can produce toxic by-products.

With regard to strength, polyethylene terephthalate (PET or PETE) and oriented polypropylene (OPP) have high tensile strengths, linear low-density polyethylene (LLDPE) and low-density polyethylene (LDPE) have high tear strengths, while those polymers having the best impact strengths are PET and polyvinyl chloride (PVC). Relative to barrier characteristics, ethylene vinyl alcohol (EVOH) and polyvinylidene chloride (PVDC) copolymers are relatively impermeable to oxygen and carbon dioxide, whereas high-density polyethylene (HDPE), polyvinylidene chloride, polypropylene, and LDPE are impervious to water vapor.

Most common polymers are relatively nonreactive with food products, and are considered safe; exceptions are acrylonitrile and plasticizers used in PVC materials that may be harmful.

The aesthetics of packaging polymers are also important in the marketing of food and drink products. Some packages will be colored, many are adorned with printing, others need to be transparent and clear, and many need to be resistant to scuffing.



On the basis of the preceding discussion, some examples of polymers that are used for specific applications are as follows:

PET(E) for soda pop containers;

PVC for beer containers;

LDPE and HDPE films for packaging bread and bakery products.

## CHAPTER 16

### COMPOSITES

#### PROBLEM SOLUTIONS

16.1 The major difference in strengthening mechanism between large-particle and dispersion-strengthened particle-reinforced composites is that for large-particle the particle-matrix interactions are not treated on the molecular level, whereas, for dispersion-strengthening these interactions are treated on the molecular level.

16.2 The similarity between precipitation hardening and dispersion strengthening is the strengthening mechanism--i.e., the precipitates/particles effectively hinder dislocation motion.

The two differences are: 1) the hardening/strengthening effect is not retained at elevated temperatures for precipitation hardening--however, it is retained for dispersion strengthening; and 2) the strength is developed by a heat treatment for precipitation hardening--such is not the case for dispersion strengthening.

16.3 The elastic modulus versus volume percent of WC is shown below, on which is included both upper and lower bound curves; these curves were generated using Equations (16.1) and (16.2), respectively, as well as the moduli of elasticity for cobalt and WC given in the problem statement.

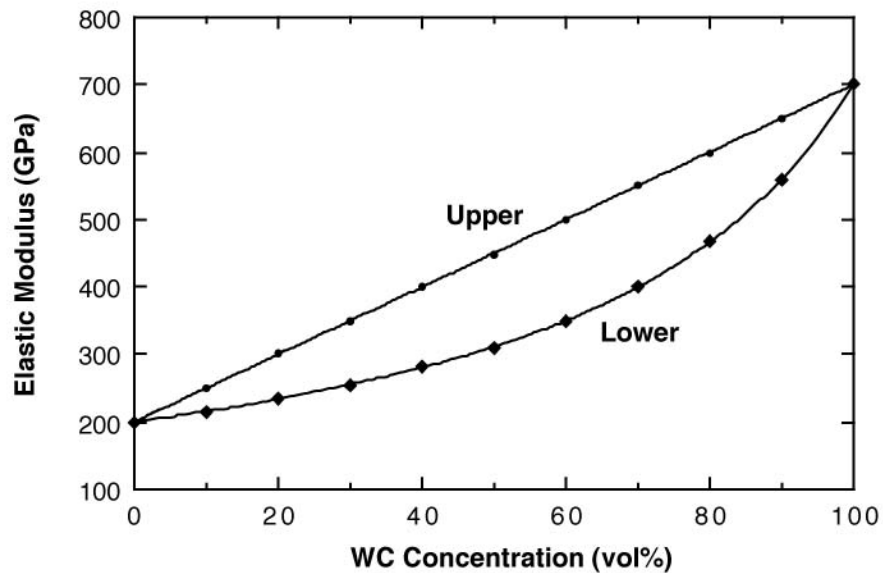

16.4 This problem asks for the maximum and minimum thermal conductivity values for a TiC-Co cermet. Using a modified form of Equation (16.1) the maximum thermal conductivity  $k_{\max}$  is calculated as

$$\begin{aligned} k_{\max} &= k_m V_m + k_p V_p = k_{\text{Co}} V_{\text{Co}} + k_{\text{TiC}} V_{\text{TiC}} \\ &= (69 \text{ W/m-K})(0.15) + (27 \text{ W/m-K})(0.85) = 33.3 \text{ W/m-K} \end{aligned}$$

And, from a modified form of Equation (16.2), the minimum thermal conductivity  $k_{\min}$  is

$$\begin{aligned} k_{\min} &= \frac{k_{\text{Co}} k_{\text{TiC}}}{V_{\text{Co}} k_{\text{TiC}} + V_{\text{TiC}} k_{\text{Co}}} \\ &= \frac{(69 \text{ W/m-K})(27 \text{ W/m-K})}{(0.15)(27 \text{ W/m-K}) + (0.85)(69 \text{ W/m-K})} \\ &= 29.7 \text{ W/m-K} \end{aligned}$$

16.5 Given the elastic moduli and specific gravities for copper and tungsten we are asked to estimate the upper limit for specific stiffness when the volume fractions of tungsten and copper are 0.70 and 0.30, respectively. There are two approaches that may be applied to solve this problem. The first is to estimate both the upper limits of elastic modulus [ $E_c(\mathbf{u})$ ] and specific gravity ( $\rho_c$ ) for the composite, using equations of the form of Equation (16.1), and then take their ratio. Using this approach

$$\begin{aligned} E_c(\mathbf{u}) &= E_{\text{Cu}} V_{\text{Cu}} + E_{\text{W}} V_{\text{W}} \\ &= (110 \text{ GPa})(0.30) + (407 \text{ GPa})(0.70) \\ &= 318 \text{ GPa} \end{aligned}$$

And

$$\begin{aligned} \rho_c &= \rho_{\text{Cu}} V_{\text{Cu}} + \rho_{\text{W}} V_{\text{W}} \\ &= (8.9)(0.30) + (19.3)(0.70) = 16.18 \end{aligned}$$

Therefore

$$\text{Specific Stiffness} = \frac{E_c(u)}{\rho_c} = \frac{318 \text{ GPa}}{16.18} = 19.65 \text{ GPa}$$

With the alternate approach, the specific stiffness is calculated, again employing a modification of Equation (16.1), but using the specific stiffness-volume fraction product for both metals, as follows:

$$\begin{aligned} \text{Specific Stiffness} &= \frac{E_{Cu}}{\rho_{Cu}} V_{Cu} + \frac{E_W}{\rho_W} V_W \\ &= \frac{110 \text{ GPa}}{8.9} (0.30) + \frac{407 \text{ GPa}}{19.3} (0.70) = 18.47 \text{ GPa} \end{aligned}$$

- 16.6 (a) The matrix phase is a continuous phase that surrounds the noncontinuous dispersed phase.  
 (b) In general, the matrix phase is relatively weak, has a low elastic modulus, but is quite ductile. On the other hand, the fiber phase is normally quite strong, stiff, and brittle.
- 16.7 (a) Concrete consists of an aggregate of particles that are bonded together by a cement.  
 (b) Three limitations of concrete are: 1) it is a relatively weak and brittle material; 2) it experiences relatively large thermal expansions (contractions) with changes in temperature; and 3) it may crack when exposed to freeze-thaw cycles.  
 (c) Three reinforcement strengthening techniques are: 1) reinforcement with steel wires, rods, etc.; 2) reinforcement with fine fibers of a high modulus material; and 3) introduction of residual compressive stresses by prestressing or posttensioning.
- 16.8 (a) Three functions of the polymer-matrix phase are: 1) to bind the fibers together so that the applied stress is distributed among the fibers; 2) to protect the surface of the fibers from being damaged; and 3) to separate the fibers and inhibit crack propagation.  
 (b) The matrix phase must be ductile and is usually relatively soft, whereas the fiber phase must be stiff and strong.  
 (c) There must be a strong interfacial bond between fiber and matrix in order to: 1) maximize the stress transmittance between matrix and fiber phases; and 2) minimize fiber pull-out, and the probability of failure.

16.9 This problem asks that, for a glass fiber-epoxy matrix combination, to determine the fiber-matrix bond strength if the critical fiber length-fiber diameter ratio is 40. Thus, we are to solve for  $\tau_c$  in

Equation (16.3). Since we are given that  $\sigma_f^* = 3.45 \text{ GPa}$  from Table 16.4, and that  $\frac{l_c}{d} = 40$ , then

$$\tau_c = \sigma_f^* \left( \frac{d}{2l_c} \right) = (3.45 \times 10^3 \text{ MPa}) \frac{1}{(2)(40)} = 43.1 \text{ MPa}$$

16.10 (a) The plot of reinforcement efficiency versus fiber length is given below.

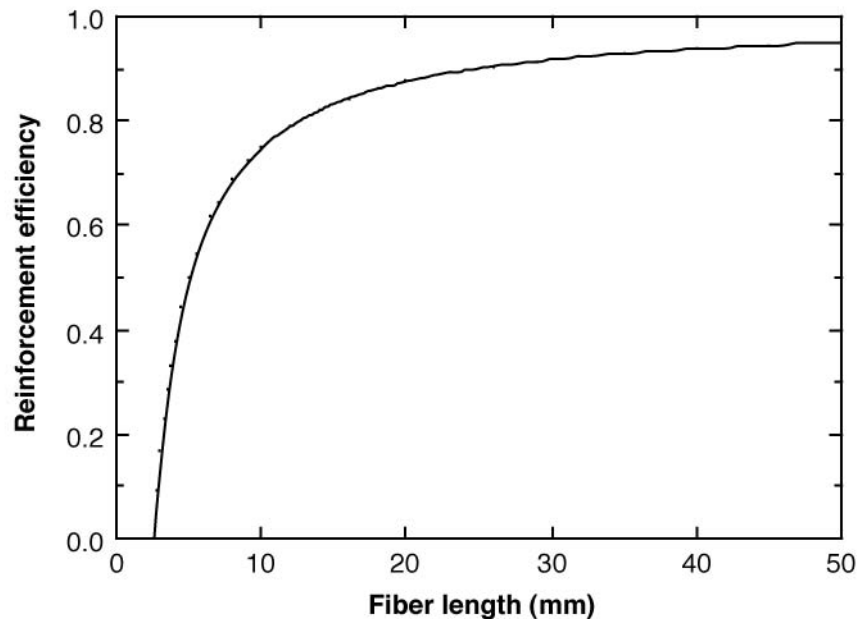

(b) This portion of the problem asks for the length required for a 0.90 efficiency of reinforcement. Solving for  $l$  from the given expression

$$l = \frac{2x}{1 - \eta}$$

Or, when  $x = 1.25 \text{ mm}$  (0.05 in.) and  $\eta = 0.90$ , then

$$l = \frac{(2)(1.25 \text{ mm})}{1 - 0.90} = 25 \text{ mm (1.0 in.)}$$

16.11 This problem calls for us to compute the longitudinal tensile strength and elastic modulus of an aramid fiber-reinforced polycarbonate composite.

(a) The longitudinal tensile strength is determined using Equation (16.17) as

$$\begin{aligned}\sigma_{cl}^* &= \sigma_m^*(1 - V_f) + \sigma_f^*V_f \\ &= (45 \text{ MPa})(0.70) + (3600 \text{ MPa})(0.30) \\ &= 1100 \text{ MPa} \quad (160,000 \text{ psi})\end{aligned}$$

(b) The longitudinal elastic modulus is computed using Equation (16.10a) as

$$\begin{aligned}E_{cl} &= E_mV_m + E_fV_f \\ &= (2.4 \text{ GPa})(0.70) + (131 \text{ GPa})(0.30) \\ &= 41 \text{ GPa} \quad (5.95 \times 10^6 \text{ psi})\end{aligned}$$

16.12 This problem asks for us to determine if it is possible to produce a continuous and oriented aramid fiber-epoxy matrix composite having longitudinal and transverse moduli of elasticity of 35 GPa and 5.17 GPa, respectively, given that the modulus of elasticity for the epoxy is 3.4 GPa. Also, from Table 16.4 the value of  $E$  for aramid fibers is 131 GPa. The approach to solving this problem is to calculate two values of  $V_f$  using the data and Equations (16.10b) and (16.16); if they are the same then this composite is possible.

For the longitudinal modulus  $E_{cl}$ ,

$$\begin{aligned}E_{cl} &= E_m(1 - V_{fl}) + E_fV_{fl} \\ 35 \text{ GPa} &= (3.4 \text{ GPa})(1 - V_{fl}) + (131 \text{ GPa})V_{fl}\end{aligned}$$

Solving this expression for  $V_{fl}$  yields  $V_{fl} = 0.248$ .

Now, repeating this procedure for the transverse modulus  $E_{ct}$

$$E_{ct} = \frac{E_m E_f}{(1 - V_{ft})E_f + V_{ft}E_m}$$

$$5.17 \text{ GPa} = \frac{(3.4 \text{ GPa})(131 \text{ GPa})}{(1 - V_{ft})(131 \text{ GPa}) + V_{ft}(3.4 \text{ GPa})}$$

Solving this expression for  $V_{ft}$  leads to  $V_{ft} = 0.351$ . Thus, since  $V_{fl}$  and  $V_{ft}$  are not equal, the proposed composite is **not possible**.

16.13 (a) This portion of the problem calls for us to calculate the specific longitudinal strengths of glass-fiber, carbon-fiber, and aramid-fiber reinforced epoxy composites, and then to compare these values with the specific strengths of several metal alloys.

The longitudinal specific strength of the glass-reinforced epoxy material ( $V_f = 0.60$ ) in Table 16.5 is just the ratio of the longitudinal tensile strength and specific gravity as

$$\frac{1020 \text{ MPa}}{2.1} = 486 \text{ MPa}$$

For the carbon-fiber reinforced epoxy

$$\frac{1240 \text{ MPa}}{1.6} = 775 \text{ MPa}$$

And, for the aramid-fiber reinforced epoxy

$$\frac{1380 \text{ MPa}}{1.4} = 986 \text{ MPa}$$

Now, for the metal alloys we use data found in Tables B.1 and B.4 in Appendix B. For the cold-rolled 7-7PH stainless steel

$$\frac{1380 \text{ MPa}}{7.65} = 180 \text{ MPa}$$

For the normalized 1040 plain carbon steel, the ratio is

$$\frac{590 \text{ MPa}}{7.85} = 75 \text{ MPa}$$

For the 7075-T6 aluminum alloy

$$\frac{572 \text{ MPa}}{2.80} = 204 \text{ MPa}$$

For the C26000 brass (cold worked)

$$\frac{525 \text{ MPa}}{8.53} = 62 \text{ MPa}$$

For the AZ31B (extruded) magnesium alloy

$$\frac{262 \text{ MPa}}{1.77} = 148 \text{ MPa}$$

For the annealed Ti-5Al-2.5Sn titanium alloy

$$\frac{790 \text{ MPa}}{4.48} = 176 \text{ MPa}$$

(b) The longitudinal specific modulus is just the longitudinal tensile modulus-specific gravity ratio.

For the glass-fiber reinforced epoxy, this ratio is

$$\frac{45 \text{ GPa}}{2.1} = 21.4 \text{ GPa}$$

For the carbon-fiber reinforced epoxy

$$\frac{145 \text{ GPa}}{1.6} = 90.6 \text{ GPa}$$

And, for the aramid-fiber reinforced epoxy

$$\frac{76 \text{ GPa}}{1.4} = 54.3 \text{ GPa}$$

The specific moduli for the metal alloys (Tables B.1 and B.2) are as follows:

For the cold rolled 17-7PH stainless steel

$$\frac{204 \text{ GPa}}{7.65} = 26.7 \text{ GPa}$$

For the normalized 1040 plain-carbon steel



$$\frac{207 \text{ GPa}}{7.85} = 26.4 \text{ GPa}$$

For the 7075-T6 aluminum alloy

$$\frac{71 \text{ GPa}}{2.80} = 25.4 \text{ GPa}$$

For the cold worked C26000 brass

$$\frac{110 \text{ GPa}}{8.53} = 12.9 \text{ GPa}$$

For the extruded AZ31B magnesium alloy

$$\frac{45 \text{ GPa}}{1.77} = 25.4 \text{ GPa}$$

For the Ti-5Al-2.5Sn titanium alloy

$$\frac{110 \text{ GPa}}{4.48} = 24.6 \text{ GPa}$$

16.14 This problem asks for us to compute the elastic moduli of fiber and matrix phases for a continuous and oriented fiber-reinforced composite. We can write expressions for the longitudinal and transverse elastic moduli using Equations (16.10b) and (16.16), as

$$E_{cl} = E_m(1 - V_f) + E_f V_f$$

$$19.7 \text{ GPa} = E_m(1 - 0.25) + E_f(0.25)$$

And

$$E_{ct} = \frac{E_m E_f}{(1 - V_f)E_f + V_f E_m}$$

$$3.66 \text{ GPa} = \frac{E_m E_f}{(1 - 0.25)E_f + 0.25E_m}$$

Solving these two expressions simultaneously for  $E_m$  and  $E_f$  leads to

$$E_m = 2.79 \text{ GPa} \quad (4.04 \times 10^5 \text{ psi})$$

$$E_f = 70.4 \text{ GPa} \quad (10.2 \times 10^6 \text{ psi})$$

16.15 (a) In order to show that the relationship in Equation (16.11) is valid, we begin with Equation (16.4),  $F_c = F_m + F_f$ , which may be manipulated to read

$$\frac{F_c}{F_m} = 1 + \frac{F_f}{F_m}$$

or

$$\frac{F_f}{F_m} = \frac{F_c}{F_m} - 1$$

For elastic deformation [Equation (6.5)]

$$\sigma = \frac{F}{A} = \varepsilon E$$

or

$$F = A\varepsilon E$$

Now we may write expressions for  $F_c$  and  $F_m$  as

$$F_c = A_c \varepsilon E_c$$

$$F_m = A_m \varepsilon E_m$$

which, when substituted into the above expression gives

$$\frac{F_f}{F_m} = \frac{A_c \varepsilon E_c}{A_m \varepsilon E_m} - 1$$

But,  $V_m = A_m/A_c$ , or

$$\frac{F_f}{F_m} = \frac{E_c}{E_m V_m} - 1$$

Also, from Equation (16.10a),  $E_c = E_m V_m + E_f V_f$ , which, when substituted into the previous expression, yields

$$\begin{aligned} \frac{F_f}{F_m} &= \frac{E_m V_m + E_f V_f}{E_m V_m} - 1 \\ &= \frac{E_m V_m + E_f V_f - E_m V_m}{E_m V_m} = \frac{E_f V_f}{E_m V_m} \end{aligned}$$

(b) This portion of the problem asks that we establish an expression for  $F_f/F_c$ . We determine this ratio in a similar manner. Now  $F_c = F_f + F_m$ , or

$$1 = \frac{F_f}{F_c} + \frac{F_m}{F_c}$$

which gives

$$\frac{F_f}{F_c} = 1 - \frac{F_m}{F_c} = 1 - \frac{A_m \varepsilon E_m}{A_c \varepsilon E_c} = 1 - \frac{A_m E_m}{A_c E_c}$$

Since  $A_m/A_c = V_m$ , then

$$\begin{aligned} \frac{F_f}{F_c} &= 1 - \frac{V_m E_m}{E_c} \\ &= 1 - \frac{V_m E_m}{V_m E_m + V_f E_f} \\ &= \frac{V_m E_m + V_f E_f - V_m E_m}{V_m E_m + V_f E_f} \\ &= \frac{V_f E_f}{V_m E_m + V_f E_f} = \frac{V_f E_f}{(1 - V_f) E_m + V_f E_f} \end{aligned}$$

16.16 (a) Given some data for an aligned glass-fiber-reinforced nylon 6,6, we are asked to compute the volume fraction of fibers that is required such that the fibers carry 94% of a load applied in the longitudinal direction. From Equation (16.11)

$$\frac{F_f}{F_m} = \frac{E_f V_f}{E_m V_m} = \frac{E_f V_f}{E_m (1 - V_f)}$$

Now,

$$\frac{F_f}{F_m} = \frac{0.94}{0.06} = 15.67$$

Substituting in for  $E_f$  and  $E_m$

$$\frac{F_f}{F_m} = 15.67 = \frac{(72.5 \text{ GPa})V_f}{(3.0 \text{ GPa})(1 - V_f)}$$

And, solving for  $V_f$  yields,  $V_f = 0.418$ .

(b) We are now asked for the tensile strength of this composite. From Equation (16.17), and using values for  $\sigma_f^*$  (3400 MPa) and  $\sigma_m'$  (30 MPa) given in the problem statement,

$$\begin{aligned} \sigma_{cl}^* &= \sigma_m' (1 - V_f) + \sigma_f^* V_f \\ &= (30 \text{ MPa})(1 - 0.418) + (3400 \text{ MPa})(0.418) \\ &= 1440 \text{ MPa} \quad (207,000 \text{ psi}) \end{aligned}$$

16.17 This problem stipulates that the cross-sectional area of a composite,  $A_c$ , is  $320 \text{ mm}^2$  ( $0.50 \text{ in.}^2$ ), and that the longitudinal load,  $F_c$ , is 44,500 N (10,000 lb<sub>f</sub>) for the composite described in Problem

16.11.

(a) First, we are asked to calculate the  $F_f/F_m$  ratio. According to Equation (16.11)

$$\frac{F_f}{F_m} = \frac{E_f V_f}{E_m V_m} = \frac{(131 \text{ GPa})(0.30)}{(2.4 \text{ GPa})(0.70)} = 23.4$$

$$\text{Or, } F_f = 23.4F_m$$

(b) Now, the actual loads carried by both phases are called for. Since

$$F_f + F_m = F_c = 44,500 \text{ N}$$

$$23.4F_m + F_m = 44,500 \text{ N}$$

which leads to

$$F_m = 1824 \text{ N (410 lb}_f\text{)}$$

$$F_f = 44,500 \text{ N} - 1824 \text{ N} = 42,676 \text{ N (9590 lb}_f\text{)}$$

(c) To compute the stress on each of the phases, it is first necessary to know the cross-sectional areas of both fiber and matrix. These are determined as

$$A_f = V_f A_c = (0.30)(320 \text{ mm}^2) = 96 \text{ mm}^2 \text{ (0.15 in.}^2\text{)}$$

$$A_m = V_m A_c = (0.70)(320 \text{ mm}^2) = 224 \text{ mm}^2 \text{ (0.35 in.}^2\text{)}$$

Now, for the stresses,

$$\sigma_f = \frac{F_f}{A_f} = \frac{42,676 \text{ N}}{96 \text{ mm}^2} = \frac{42,676 \text{ N}}{96 \times 10^{-6} \text{ m}^2} = 445 \text{ MPa (63,930 psi)}$$

$$\sigma_m = \frac{F_m}{A_m} = \frac{1824 \text{ N}}{224 \text{ mm}^2} = \frac{1824 \text{ N}}{224 \times 10^{-6} \text{ m}^2} = 8.14 \text{ MPa (1170 psi)}$$

(d) The strain on the composite is the same as the strain on each of the matrix and fiber phases, as

$$\varepsilon_m = \frac{\sigma_m}{E_m} = \frac{8.14 \text{ MPa}}{2.4 \times 10^3 \text{ MPa}} = 3.39 \times 10^{-3}$$

$$\varepsilon_f = \frac{\sigma_f}{E_f} = \frac{445 \text{ MPa}}{131 \times 10^3 \text{ MPa}} = 3.39 \times 10^{-3}$$

16.18 For a continuous and aligned fibrous composite, we are given its cross-sectional area ( $970 \text{ mm}^2$ ), the stresses sustained by the fiber and matrix phases (215 and 5.38 MPa), the force sustained by the fiber phase (76,800 N), and the total longitudinal strain ( $1.56 \times 10^{-3}$ ).

(a) For this portion of the problem we are asked to calculate the force sustained by the matrix phase. It is first necessary to compute the volume fraction of the matrix phase,  $V_m$ . This may be accomplished by first determining  $V_f$  and then  $V_m$  from  $V_m = 1 - V_f$ . The value of  $V_f$  may be calculated realizing that

$$\sigma_f = \frac{F_f}{A_f} = \frac{F_f}{V_f A_c}$$

Or

$$V_f = \frac{F_f}{\sigma_f A_c} = \frac{76,800 \text{ N}}{(215 \times 10^6 \text{ N/m}^2)(0.970 \times 10^{-3} \text{ m}^2)} = 0.369$$

Now

$$V_m = 1 - V_f = 1 - 0.369 = 0.631$$

Therefore, since

$$\sigma_m = \frac{F_m}{A_m} = \frac{F_m}{V_m A_c}$$

then

$$F_m = V_m \sigma_m A_c = (0.631)(5.38 \times 10^6 \text{ N/m}^2)(0.970 \times 10^{-3} \text{ m}^2) = 3290 \text{ N} \quad (738 \text{ lb}_f)$$

(b) We are now asked to calculate the modulus of elasticity in the longitudinal direction. This is possible realizing that  $E_c = \frac{\sigma_c}{\epsilon}$  and that  $\sigma_c = \frac{F_m + F_f}{A_c}$ . Thus

$$\begin{aligned} E_c &= \frac{F_m + F_f}{\epsilon A_c} \\ &= \frac{3290 \text{ N} + 76,800 \text{ N}}{(1.56 \times 10^{-3})(0.970 \times 10^{-3} \text{ m}^2)} = 52.9 \text{ GPa} \quad (7.69 \times 10^6 \text{ psi}) \end{aligned}$$

(c) Finally, it is necessary to determine the moduli of elasticity for the fiber and matrix phases. This is possible as follows:

$$E_m = \frac{\sigma_m}{\varepsilon_m} = \frac{\sigma_m}{\varepsilon_c} = \frac{5.38 \times 10^6 \text{ N/m}^2}{1.56 \times 10^{-3}} = 3.45 \times 10^9 \text{ N/m}^2$$

$$= 3.45 \text{ GPa} \quad (5.0 \times 10^5 \text{ psi})$$

$$E_f = \frac{\sigma_f}{\varepsilon_f} = \frac{\sigma_f}{\varepsilon_c} = \frac{215 \times 10^6 \text{ N/m}^2}{1.56 \times 10^{-3}} = 1.38 \times 10^{11} \text{ N/m}^2$$

$$= 138 \text{ GPa} \quad (20 \times 10^6 \text{ psi})$$

16.19 In this problem, for an aligned carbon fiber-epoxy matrix composite, we are given the volume fraction of fibers (0.20), the average fiber diameter ( $6 \times 10^{-3}$  mm), the average fiber length (8.0 mm), the average fiber fracture strength (4.5 GPa), the fiber-matrix bond strength (75 MPa), the matrix stress at composite failure (6.0 MPa), and the matrix tensile strength (60 MPa); and we are asked to compute the longitudinal strength. It is first necessary to compute the value of the critical fiber length using Equation (16.3). If the fiber length is much greater than  $l_c$ , then we may determine the longitudinal strength using Equation (16.17), otherwise, use of either Equation (16.18) or (16.19) is necessary. Thus,

$$l_c = \frac{\sigma_f^* d}{2\tau_c} = \frac{(4.5 \times 10^3 \text{ MPa})(6 \times 10^{-3} \text{ mm})}{2(75 \text{ MPa})} = 0.18 \text{ mm}$$

Inasmuch as  $l \gg l_c$  (8.0 mm  $\gg$  0.18 mm), then use of Equation (16.17) is appropriate. Therefore,

$$\begin{aligned} \sigma_{cl} &= \sigma_m'(1 - V_f) + \sigma_f^* V_f \\ &= (6 \text{ MPa})(1 - 0.20) + (4500 \text{ MPa})(0.20) \\ &= 905 \text{ MPa} \quad (130,700 \text{ psi}) \end{aligned}$$

16.20 In this problem, for an aligned carbon fiber-epoxy matrix composite, we are given the desired longitudinal tensile strength (500 MPa), the average fiber diameter ( $1.0 \times 10^{-2}$  mm), the average fiber length (0.5 mm), the fiber fracture strength (4000 MPa), the fiber-matrix bond strength (25 MPa), and the matrix stress at composite failure (7.0 MPa); and we are asked to compute the

volume fraction of fibers that is required. It is first necessary to compute the value of the critical fiber length using Equation (16.3). If the fiber length is much greater than  $l_c$ , then we may determine  $V_f$  using Equation (16.17), otherwise, use of either Equation (16.18) or Equation (16.19) is necessary. Thus,

$$l_c = \frac{\sigma_f^* d}{2\tau_c} = \frac{(4000 \text{ MPa})(1.0 \times 10^{-2} \text{ mm})}{2(25 \text{ MPa})} = 0.80 \text{ mm}$$

Inasmuch as  $l < l_c$  ( $0.50 \text{ mm} < 0.80 \text{ mm}$ ), then use of Equation (16.19) is required. Therefore,

$$\sigma_{cd}^* = \frac{l\tau_c}{d} V_f + \sigma_m'(1 - V_f)$$

$$500 \text{ MPa} = \frac{(0.5 \times 10^{-3} \text{ m})(25 \text{ MPa})}{0.01 \times 10^{-3} \text{ m}} (V_f) + (7 \text{ MPa})(1 - V_f)$$

Solving this expression for  $V_f$  leads to  $V_f = 0.397$ .

16.21 In this problem, for an aligned glass fiber-epoxy matrix composite, we are asked to compute the longitudinal tensile strength given the following: the average fiber diameter (0.015 mm), the average fiber length (2.0 mm), the volume fraction of fibers (0.25), the fiber fracture strength (3500 MPa), the fiber-matrix bond strength (100 MPa), and the matrix stress at composite failure (5.5 MPa). It is first necessary to compute the value of the critical fiber length using Equation (16.3). If the fiber length is much greater than  $l_c$ , then we may determine  $\sigma_{cl}^*$  using Equation (16.17), otherwise, use of either Equation (16.18) or (16.19) is necessary. Thus,

$$l_c = \frac{\sigma_f^* d}{2\tau_c} = \frac{(3500 \text{ MPa})(0.015 \text{ mm})}{2(100 \text{ MPa})} = 0.263 \text{ mm} \quad (0.010 \text{ in.})$$

Inasmuch as  $l > l_c$  ( $2.0 \text{ mm} > 0.263 \text{ mm}$ ), but  $l$  is not much greater than  $l_c$ , then use of Equation (16.18) is necessary. Therefore,

$$\sigma_{cd}^* = \sigma_f^* V_f \left(1 - \frac{l_c}{2l}\right) + \sigma_m'(1 - V_f)$$



$$= (3500 \text{ MPa})(0.25) \left[ 1 - \frac{0.263 \text{ mm}}{(2)(2.0 \text{ mm})} \right] + (5.5 \text{ MPa})(1 - 0.25)$$

$$= 822 \text{ MPa (117,800 psi)}$$

16.22 (a) This portion of the problem calls for computation of values of the fiber efficiency parameter. From Equation (16.20)

$$E_{cd} = KE_f V_f + E_m V_m$$

Solving this expression for **K** yields

$$K = \frac{E_{cd} - E_m V_m}{E_f V_f} = \frac{E_{cd} - E_m (1 - V_f)}{E_f V_f}$$

For glass fibers,  $E_f = 72.5 \text{ GPa}$  (Table 16.4); using the data in Table 16.2, and taking an average of the extreme  $E_m$  values given,  $E_m = 2.29 \text{ GPa}$  ( $0.333 \times 10^6 \text{ psi}$ ). And, for  $V_f = 0.20$

$$K = \frac{5.93 \text{ GPa} - (2.29 \text{ GPa})(1 - 0.2)}{(72.5 \text{ GPa})(0.2)} = 0.283$$

For  $V_f = 0.3$

$$K = \frac{8.62 \text{ GPa} - (2.29 \text{ GPa})(1 - 0.3)}{(72.5 \text{ GPa})(0.3)} = 0.323$$

And, for  $V_f = 0.4$

$$K = \frac{11.6 \text{ GPa} - (2.29 \text{ GPa})(1 - 0.4)}{(72.5 \text{ GPa})(0.4)} = 0.353$$

(b) For 50 vol% fibers ( $V_f = 0.50$ ), we must assume a value for **K**. Since **K** increases slightly with  $V_f$ , let us assume that the increase in going from  $V_f = 0.4$  to 0.5 is the same as from 0.3 to 0.4--that is, by a value of 0.03. Therefore, let us assume a value for **K** of 0.383. Now, from Equation (16.20)

$$E_c = KE_f V_f + E_m V_m$$

$$\begin{aligned}
&= (0.383)(72.5 \text{ GPa})(0.5) + (2.29 \text{ GPa})(0.5) \\
&= 15.0 \text{ GPa} \quad (2.18 \times 10^6 \text{ psi})
\end{aligned}$$

16.23 For discontinuous-oriented fiber-reinforced composites one desirable characteristic is that the composite is relatively strong and stiff in one direction; a less desirable characteristic is that the mechanical properties are anisotropic.

For discontinuous and random fiber-reinforced, one desirable characteristic is that the properties are isotropic; a less desirable characteristic is there is no single high-strength direction.

16.24 (a) The four reasons why glass fibers are most commonly used for reinforcement are listed at the beginning of Section 16.8 under "Glass Fiber-Reinforced Polymer (GFRP) Composites."

(b) The surface perfection of glass fibers is important because surface flaws or cracks will act as points of stress concentration, which will dramatically reduce the tensile strength of the material.

(c) Care must be taken not to rub or abrade the surface after the fibers are drawn. As a surface protection, newly drawn fibers are coated with a protective surface film.

16.25 "Graphite" is crystalline carbon having the structure shown in Figure 12.17, whereas "carbon" will consist of some noncrystalline material as well as areas of crystal misalignment.

16.26 (a) Reasons for the extensive use of fiberglass-reinforced composites are as follows: 1) glass fibers are very inexpensive to produce; 2) these composites have relatively high specific strengths; and 3) they are chemically inert in a wide variety of environments.

(b) Several limitations of these composites are: 1) care must be exercised in handling the fibers inasmuch as they are susceptible to surface damage; 2) they lack the stiffness found in other fibrous composites; and 3) they are limited as to maximum temperature use.

16.27 (a) A hybrid composite is one that is reinforced with two or more different fiber materials in a single matrix.

(b) Two advantages of hybrid composites are: 1) better overall property combinations, and 2) failure is not as catastrophic as with single-fiber composites.

16.28 (a) For a hybrid composite having all fibers aligned in the same direction

$$E_{cl} = E_m V_m + E_{f1} V_{f1} + E_{f2} V_{f2}$$

in which the subscripts **f1** and **f2** refer to the two types of fibers.

(b) Now we are asked to compute the longitudinal elastic modulus for a glass- and aramid-fiber hybrid composite. From Table 16.4, the elastic moduli of aramid and glass fibers are, respectively, 131 GPa ( $19 \times 10^6$  psi) and 72.5 GPa ( $10.5 \times 10^6$  psi). Thus, from the previous expression

$$\begin{aligned} E_{cl} &= (2.5 \text{ GPa})(1.0 - 0.30 - 0.40) + (131 \text{ GPa})(0.30) \\ &\quad + (72.5 \text{ GPa})(0.40) \\ &= 69.1 \text{ GPa} \quad (10.0 \times 10^6 \text{ psi}) \end{aligned}$$

16.29 This problem asks that we derive a generalized expression analogous to Equation (16.16) for the transverse modulus of elasticity of an aligned hybrid composite consisting of two types of continuous fibers. Let us use the subscripts **f1** and **f2** to denote the two fiber types, and **m**, **c**, and **t** as subscripts for the matrix, composite, and transverse direction, respectively. For the isostress state, the expressions analogous to Equations (16.12) and (16.13) are

$$\sigma_c = \sigma_m = \sigma_{f1} = \sigma_{f2}$$

And

$$\varepsilon_c = \varepsilon_m V_m + \varepsilon_{f1} V_{f1} + \varepsilon_{f2} V_{f2}$$

Since  $\varepsilon = \sigma/E$ , then

$$\frac{\sigma}{E_{ct}} = \frac{\sigma}{E_m} V_m + \frac{\sigma}{E_{f1}} V_{f1} + \frac{\sigma}{E_{f2}} V_{f2}$$

And

$$\frac{1}{E_{ct}} = \frac{V_m}{E_m} + \frac{V_{f1}}{E_{f1}} + \frac{V_{f2}}{E_{f2}}$$

$$\frac{1}{E_{ct}} = \frac{V_m E_{f1} E_{f2} + V_{f1} E_m E_{f2} + V_{f2} E_m E_{f1}}{E_m E_{f1} E_{f2}}$$

And, finally

$$E_{ct} = \frac{E_m E_{f1} E_{f2}}{V_m E_{f1} E_{f2} + V_{f1} E_m E_{f2} + V_{f2} E_m E_{f1}}$$

16.30 Pultrusion, filament winding, and prepreg fabrication processes are described in Section 16.13.

For pultrusion, the advantages are: the process may be automated, production rates are relatively high, a wide variety of shapes having constant cross-sections are possible, and very long pieces may be produced. The chief disadvantage is that shapes are limited to those having a constant cross-section.

For filament winding, the advantages are: the process may be automated, a variety of winding patterns are possible, and a high degree of control over winding uniformity and orientation is afforded. The chief disadvantage is that the variety of shapes is somewhat limited.

For prepreg production, the advantages are: resin does not need to be added to the prepreg, the lay-up arrangement relative to the orientation of individual plies is variable, and the lay-up process may be automated. The chief disadvantages of this technique are that final curing is necessary after fabrication, and thermoset prepregs must be stored at subambient temperatures to prevent complete curing.

16.31 Laminar composites are a series of sheets or panels, each of which has a preferred high-strength direction. These sheets are stacked and then cemented together such that the orientation of the high-strength direction varies from layer to layer.

These composites are constructed in order to have a relatively high strength in virtually all directions within the plane of the laminate.

16.32 (a) Sandwich panels consist of two outer face sheets of a high-strength material that are separated by a layer of a less-dense and lower-strength core material.

(b) The prime reason for fabricating these composites is to produce structures having high in-plane strengths, high shear rigidities, and low densities.

(c) The faces function so as to bear the majority of in-plane loading and also transverse bending stresses. On the other hand, the core separates the faces and resists deformations perpendicular to the faces.

### Design Problems

16.D1 In order to solve this problem, we want to make longitudinal elastic modulus and tensile strength computations assuming 50 vol% fibers for all three fiber materials, in order to see which meet the stipulated criteria [i.e., a minimum elastic modulus of 50 GPa ( $7.3 \times 10^6$  psi), and a minimum tensile

strength of 1300 MPa (189,000 psi)]. Thus, it becomes necessary to use Equations (16.10b) and (16.17) with  $V_m = 0.5$  and  $V_f = 0.5$ ,  $E_m = 3.1$  GPa, and  $\sigma_m^* = 75$  MPa.

For glass,  $E_f = 72.5$  GPa and  $\sigma_f^* = 3450$  MPa. Therefore,

$$E_{cl} = E_m(1 - V_f) + E_f V_f$$

$$= (3.1 \text{ GPa})(1 - 0.5) + (72.5 \text{ GPa})(0.5) = 37.8 \text{ GPa} \quad (5.48 \times 10^6 \text{ psi})$$

Since this is less than the specified minimum, glass is not an acceptable candidate.

For carbon (PAN standard-modulus),  $E_f = 230$  GPa and  $\sigma_f^* = 4000$  MPa (the average of the extreme values in Table B.4), thus

$$E_{cl} = (3.1 \text{ GPa})(0.5) + (230 \text{ GPa})(0.5) = 116.6 \text{ GPa} \quad (16.9 \times 10^6 \text{ psi})$$

which is greater than the specified minimum. In addition, from Equation (16.17)

$$\sigma_{cl}^* = \sigma_m^*(1 - V_f) + \sigma_f^* V_f$$

$$= (30 \text{ MPa})(0.5) + (4000 \text{ MPa})(0.5) = 2015 \text{ MPa} \quad (292,200 \text{ psi})$$

which is also greater than the minimum. Thus, carbon (PAN standard-modulus) is a candidate.

For aramid,  $E_f = 131$  GPa and  $\sigma_f^* = 3850$  MPa (the average of the extreme values in Table B.4), thus

$$E_{cl} = (3.1 \text{ GPa})(0.5) + (131 \text{ GPa})(0.5) = 67.1 \text{ GPa} \quad (9.73 \times 10^6 \text{ psi})$$

which value is greater than the minimum. Also, from Equation (16.17)

$$\sigma_{cl}^* = \sigma_m^*(1 - V_f) + \sigma_f^* V_f$$

$$= (50 \text{ MPa})(0.5) + (3850 \text{ MPa})(0.5) = 1950 \text{ MPa} \quad (283,600 \text{ psi})$$

which is also greater than the minimum strength value. Therefore, of the three fiber materials, both the carbon (PAN standard-modulus) and the aramid meet both minimum criteria.

16.D2 This problem asks us to determine whether or not it is possible to produce a continuous and oriented carbon fiber-reinforced epoxy having a modulus of elasticity of at least 83 GPa in the direction of fiber alignment, and a maximum specific gravity of 1.40. We will first calculate the minimum volume fraction of fibers to give the stipulated elastic modulus, and then the maximum volume fraction of fibers required to yield the maximum permissible specific gravity; if there is an overlap of these two fiber volume fractions then such a composite is possible.

With regard to the elastic modulus, from Equation (16.10b)

$$E_{cl} = E_m(1 - V_f) + E_f V_f$$

$$83 \text{ GPa} = (2.4 \text{ GPa})(1 - V_f) + (260 \text{ GPa})(V_f)$$

Solving for  $V_f$  yields  $V_f = 0.31$ . Therefore,  $V_f > 0.31$  to give the minimum desired elastic modulus.

Now, upon consideration of the specific gravity,  $\rho$ , we employ a modified form of Equation (16.10b) as

$$\rho_c = \rho_m(1 - V_f) + \rho_f V_f$$

$$1.40 = 1.25(1 - V_f) + 1.80(V_f)$$

And, solving for  $V_f$  from this expression gives  $V_f = 0.27$ . Therefore, it is necessary for  $V_f < 0.27$  in order to have a composite specific gravity less than 1.40.

Hence, such a composite is **not** possible since there is no overlap of the fiber volume fractions (i.e.,  $0.31 < V_f < 0.27$ ) as computed using the two stipulated criteria.

16.D3 This problem asks us to determine whether or not it is possible to produce a continuous and oriented glass fiber-reinforced polyester having a tensile strength of at least 1250 MPa in the longitudinal direction, and a maximum specific gravity of 1.80. We will first calculate the minimum volume fraction of fibers to give the stipulated tensile strength, and then the maximum volume fraction of fibers possible to yield the maximum permissible specific gravity; if there is an overlap of these two fiber volume fractions then such a composite is possible.

With regard to tensile strength, from Equation (16.17)

$$\sigma_{cl}^* = \sigma_m'(1 - V_f) + \sigma_f^* V_f$$

$$1250 \text{ MPa} = (20 \text{ MPa})(1 - V_f) + (3500 \text{ MPa})(V_f)$$

Solving for  $V_f$  yields  $V_f = 0.353$ . Therefore,  $V_f > 0.353$  to give the minimum desired tensile strength.

Now, upon consideration of the specific gravity,  $\rho$ , we employ the following modified form of Equation (16.10b) as

$$\rho_c = \rho_m(1 - V_f) + \rho_f V_f$$

$$1.80 = 1.35(1 - V_f) + 2.50(V_f)$$

And, solving for  $V_f$  from this expression gives  $V_f = 0.391$ . Therefore, it is necessary for  $V_f < 0.391$  in order to have a composite specific gravity less than 1.80.

Hence, such a composite is possible if  $0.353 < V_f < 0.391$ .

16.D4 In this problem, for an aligned and discontinuous glass fiber-epoxy matrix composite having a longitudinal tensile strength of 1200 MPa, we are asked to compute the required fiber fracture strength, given the following: the average fiber diameter (0.015 mm), the average fiber length (5.0 mm), the volume fraction of fibers (0.35), the fiber-matrix bond strength (80 MPa), and the matrix stress at fiber failure (6.55 MPa).

To begin, since the value of  $\sigma_f^*$  is unknown, calculation of the value of  $I_c$  in Equation (16.3) is not possible, and, therefore, we are not able to decide which of Equations (16.18) and (16.19) to use. Thus, it is necessary to substitute for  $I_c$  in Equation (16.3) into Equation (16.18), solve for the value of  $\sigma_f^*$ , then, using this value, solve for  $I_c$  from Equation (16.3). If  $l > I_c$ , we use Equation (16.18), otherwise Equation (16.19) must be used. Note: the  $\sigma_f^*$  parameters in Equations (16.18) and (16.3) are the same. Realizing this, and substituting for  $I_c$  in Equation (16.3) into Equation (16.18) leads to

$$\sigma_{cd}^* = \sigma_f^* V_f \left[ 1 - \frac{\sigma_f^* d}{4\tau_c l} \right] + \sigma_m'(1 - V_f)$$

$$= \sigma_f^* V_f - \frac{\sigma_f^{*2} V_f d}{4\tau_c l} + \sigma_m' - \sigma_m' V_f$$

This expression is a quadratic equation in which  $\sigma_f^*$  is the unknown. Rearrangement into a more convenient form leads to

$$\sigma_f^{*2} \left[ \frac{V_f d}{4\tau_c l} \right] - \sigma_f^* (V_f) + [\sigma_{cd}' - \sigma_m' (1 - V_f)] = 0$$

Or

$$a\sigma_f^{*2} + b\sigma_f^* + c = 0$$

In which

$$a = \frac{V_f d}{4\tau_c l}$$

$$= \frac{(0.35)(0.015 \times 10^{-3} \text{ m})}{(4)(80 \text{ MPa})(5 \times 10^{-3} \text{ m})} = 3.28 \times 10^{-6} (\text{MPa})^{-1} \quad [2.23 \times 10^{-8} (\text{psi})^{-1}]$$

Furthermore,

$$b = -V_f = -0.35$$

$$c = \sigma_{cd}' - \sigma_m' (1 - V_f)$$

$$= 1200 \text{ MPa} - (6.55 \text{ MPa})(1 - 0.35) = 1195.74 \text{ MPa} \quad (174,383 \text{ psi})$$

Now solving the above quadratic equation for  $\sigma_f^*$  yields

$$\sigma_f^* = \frac{-b \pm \sqrt{b^2 - 4ac}}{2a}$$

$$= \frac{-(-0.35) \pm \sqrt{(-0.35)^2 - (4)[3.28 \times 10^{-6} (\text{MPa})^{-1}](1195.74 \text{ MPa})}}{(2)[3.28 \times 10^{-6} (\text{MPa})^{-1}]}$$



$$= \frac{0.3500 \pm 0.3268}{6.56 \times 10^{-6}} \text{ MPa} \left[ \frac{0.3500 \pm 0.3270}{4.46 \times 10^{-8}} \text{ psi} \right]$$

This yields the two possible roots as

$$\sigma_f^*(+) = \frac{0.3500 + 0.3268}{6.56 \times 10^{-6}} \text{ MPa} = 103,200 \text{ MPa} \quad (15.2 \times 10^6 \text{ psi})$$

$$\sigma_f^*(-) = \frac{0.3500 - 0.3268}{6.56 \times 10^{-6}} \text{ MPa} = 3537 \text{ MPa} \quad (515,700 \text{ psi})$$

Upon consultation of the magnitudes of  $\sigma_f^*$  for various fibers and whiskers in Table 16.4, only  $\sigma_f^*(-)$  is reasonable. Now, using this value, let us calculate the value of  $l_c$  using Equation (16.3) in order to ascertain if use of Equation (16.18) in the previous treatment was appropriate. Thus

$$l_c = \frac{\sigma_f^* d}{2\tau_c} = \frac{(3537 \text{ MPa})(0.015 \text{ mm})}{(2)(80 \text{ MPa})} = 0.33 \text{ mm} \quad (0.0131 \text{ in.})$$

Since  $l > l_c$  (5.0 mm > 0.33 mm), our choice of Equation (16.18) was indeed appropriate, and  $\sigma_f^* = 3537 \text{ MPa}$  (515,700 psi).

16.D5 (a) This portion of the problem calls for the same volume fraction of fibers for the four fiber types (i.e.,  $V_f = 0.40$ ); thus, the modulus of elasticity will vary according to Equation (16.24a) with  $\cos \theta = \cos (17.5^\circ) = 0.954$ . Hence

$$E_{cs} = 0.954(E_m V_m + E_f V_f)$$

And, using data in Table 16.8, the value of  $E_{cs}$  may be determined for each fiber material; these are tabulated in Table 16.D5a.

Table 16.D5a Composite Elastic Modulus for Each of Glass and Three Carbon Fiber Types for  $V_f = 0.40$

Fiber Type	$E_{cs}$	
	GPa	$10^6$ psi
Glass	29.0	4.2
Carbon--standard modulus	89.1	12.9
Carbon--intermediate modulus	110	16.0
Carbon--high modulus	154	22.3

It now becomes necessary to determine, for each fiber type, the inside diameter  $d_i$ .

Rearrangement of Equation 16.23 leads to

$$d_i = \left[ d_o^4 - \frac{4FL^3}{3\pi E \Delta y} \right]^{1/4}$$

The  $d_i$  values may be computed by substitution into this expression for  $E$  the  $E_{cs}$  data in Table 16.D5a and the following

$$F = 100 \text{ N}$$

$$L = 0.75 \text{ m}$$

$$\Delta y = 2.5 \text{ mm}$$

$$d_o = 100 \text{ mm}$$

These  $d_i$  data are tabulated in the second column of Table 16.D5b. No entry is included for glass.

The elastic modulus for glass fibers is so low that it is not possible to use them for a tube that meets the stipulated criteria; mathematically, the term within brackets in the above equation for  $d_i$  is negative, and no real root exists. Thus, only the three carbon types are candidate fiber materials.

Table 16.D5b Inside Tube Diameter, Total Volume, and Fiber, Matrix, and Total Costs for Three Carbon-Fiber Epoxy-Matrix Composites

Fiber Type	Inside Diameter (mm)	Total Volume (cm <sup>3</sup> )	Fiber Cost (\$)	Matrix Cost (\$)	Total Cost (\$)
Glass	-	-	-	-	-
Carbon--standard modulus	66.6	3324	83.76	20.46	104.22
Carbon--intermediate modulus	76.9	2407	121.31	14.82	136.13
Carbon--high modulus	85.5	1584	199.58	9.75	209.33

(b) Also included in Table 16.D5b is the total volume of material required for the tubular shaft for each carbon fiber type; Equation (16.25) was utilized for these computations. Since  $V_f = 0.40$ , 40% this volume is fiber and the other 60% is epoxy matrix. In the manner of Design Example 16.1, the masses and costs of fiber and matrix materials were determined, as well as the total composite cost. These data are also included in Table 16.D5b. Here it may be noted that the standard-carbon fiber yields the least expensive composite, followed by the intermediate- and high-modulus materials.

16.D6 This problem is to be solved using the **E-Z Solve** software.

16.D7 Inasmuch as there are a number of different sports implements that employ composite materials, no attempt will be made to provide a complete answer for this question. However, a list of this type of sporting equipment would include skis and ski poles, fishing rods, vaulting poles, golf clubs, hockey sticks, baseball and softball bats, surfboards and boats, oars and paddles, bicycle components (frames, wheels, handlebars), canoes, and tennis and racquetball rackets.

16.D8 The primary reasons that the automotive industry has replaced metallic automobile components with polymer and composite materials are: polymers/composites 1) have lower densities, and afford higher fuel efficiencies; 2) may be produced at lower costs but with comparable mechanical

characteristics; 3) are in many environments more corrosion resistant; 4) reduce noise, and 5) are thermally insulating and thus reduce the transference of heat.

These replacements are many and varied. Several are as follows:

Bumper fascia are molded from an elastomer-modified polypropylene.

Overhead consoles are made of polyphenylene oxide and recycled polycarbonate.

Rocker arm covers are injection molded of a glass- and mineral-reinforced nylon 6,6 composite.

Torque converter reactors, water outlets, pulleys, and brake pistons, are made from phenolic thermoset composites that are reinforced with glass fibers.

Air intake manifolds are made of a glass-reinforced nylon 6,6.

## CHAPTER 17

### CORROSION AND DEGRADATION OF MATERIALS

#### PROBLEM SOLUTIONS

17.1 (a) Oxidation is the process by which an atom gives up an electron (or electrons) to become a cation.

Reduction is the process by which an atom acquires an extra electron (or electrons) and becomes an anion.

(b) Oxidation occurs at the anode; reduction at the cathode.

17.2 (a) This problem asks that we write possible oxidation and reduction half-reactions for magnesium in various solutions.

(i) In HCl

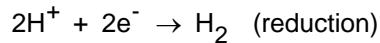
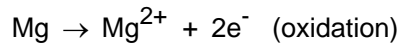

(ii) In an HCl solution containing dissolved oxygen

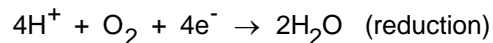
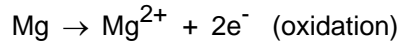

(iii) In an HCl solution containing dissolved oxygen and  $\text{Fe}^{2+}$  ions

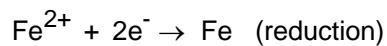
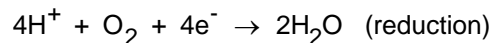
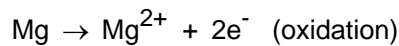

(b) The magnesium would probably oxidize most rapidly in the HCl solution containing dissolved oxygen and  $\text{Fe}^{2+}$  ions because there are two reduction reactions that will consume electrons from the oxidation of magnesium.

17.3 Iron would not corrode in water of high purity because all of the reduction reactions, Equations (17.3) through (17.7), depend on the presence of some impurity substance such as  $\text{H}^+$  or  $\text{M}^{n+}$  ions or dissolved oxygen.

17.4 (a) The Faraday constant is just the product of the charge per electron and Avogadro's number; that is

$$F = eN_A = \left(1.602 \times 10^{-19} \text{ C/electron}\right) \left(6.023 \times 10^{23} \text{ electrons/mol}\right)$$

$$= 96,488 \text{ C/mol}$$

(b) At 25°C (298 K),

$$\frac{RT}{nF} \ln(x) = \frac{(8.31 \text{ J/mol} \cdot \text{K})(298 \text{ K})}{(n)(96,500 \text{ C/mol})} (2.303) \log(x)$$

$$= \frac{0.0592}{n} \log(x)$$

This gives units in volts since a volt is a J/C.

17.5 (a) We are asked to compute the voltage of a nonstandard Cd-Fe electrochemical cell. Since iron is lower in the emf series (Table 17.1), we begin by assuming that iron is oxidized and cadmium is reduced, as

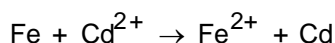

and

$$\Delta V = (V_{\text{Cd}}^{\circ} - V_{\text{Fe}}^{\circ}) - \frac{0.0592}{2} \log \frac{[\text{Fe}^{2+}]}{[\text{Cd}^{2+}]}$$

$$= [-0.403 \text{ V} - (-0.440 \text{ V})] - \frac{0.0592}{2} \log \left[ \frac{0.40}{2 \times 10^{-3}} \right]$$

$$= -0.031 \text{ V}$$

(b) Since this  $\Delta V$  is negative, the spontaneous cell direction is just the reverse of that above, or

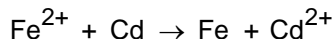

17.6 This problem calls for us to determine whether or not a voltage is generated in a Zn/Zn<sup>2+</sup> concentration cell, and, if so, its magnitude. Let us label the Zn cell having a 1.0 M Zn<sup>2+</sup> solution as cell 1, and the other as cell 2. Furthermore, assume that oxidation occurs within cell 2, wherein Zn<sub>2</sub><sup>2+</sup> = 10<sup>-2</sup> M. Hence,

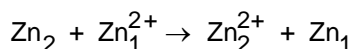

and

$$\begin{aligned} \Delta V &= - \frac{0.0592}{2} \log \frac{[\text{Zn}_2^{2+}]}{[\text{Zn}_1^{2+}]} \\ &= - \frac{0.0592}{2} \log \left[ \frac{10^{-2}}{1.0} \right] = +0.0592 \text{ V} \end{aligned}$$

Therefore, a voltage of 0.0592 V is generated when oxidation occurs in the cell having the Zn<sup>2+</sup> concentration of 10<sup>-2</sup> M.

17.7 We are asked to calculate the concentration of Pb<sup>2+</sup> ions in a copper-lead electrochemical cell. The electrochemical reaction that occurs within this cell is just

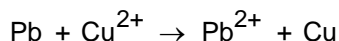

while  $\Delta V = 0.507 \text{ V}$  and  $[\text{Cu}^{2+}] = 0.6 \text{ M}$ . Thus, Equation (17.20) is written in the form

$$\Delta V = (V_{\text{Cu}}^{\circ} - V_{\text{Pb}}^{\circ}) - \frac{0.0592}{2} \log \frac{[\text{Pb}^{2+}]}{[\text{Cu}^{2+}]}$$

Solving this expression for  $[\text{Pb}^{2+}]$  gives

$$[\text{Pb}^{2+}] = [\text{Cu}^{2+}] \exp - \left[ (2.303) \frac{\Delta V - (V_{\text{Cu}}^{\circ} - V_{\text{Pb}}^{\circ})}{0.0296} \right]$$

The standard potentials from Table 17.1 are  $V_{\text{Cu}}^{\circ} = +0.340 \text{ V}$  and  $V_{\text{Pb}}^{\circ} = -0.126 \text{ V}$ . Therefore,

$$\begin{aligned} [\text{Pb}^{2+}] &= (0.6 \text{ M}) \exp - \left[ (2.303) \frac{0.507 \text{ V} - (0.340 \text{ V} + 0.126 \text{ V})}{0.0296} \right] \\ &= 2.5 \times 10^{-2} \text{ M} \end{aligned}$$

17.8 This problem asks for us to calculate the temperature for a zinc-lead electrochemical cell when the potential between the Zn and Pb electrodes is +0.568 V. On the basis of their relative positions in the standard emf series (Table 17.1), assume that Zn is oxidized and Pb is reduced. Thus, the electrochemical reaction that occurs within this cell is just

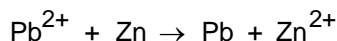

Thus, Equation (17.20) is written in the form

$$\Delta V = (V_{\text{Pb}}^{\circ} - V_{\text{Zn}}^{\circ}) - \frac{RT}{nF} \ln \frac{[\text{Zn}^{2+}]}{[\text{Pb}^{2+}]}$$

Solving this expression for **T** gives

$$T = - \frac{nF}{R} \left[ \frac{\Delta V - (V_{\text{Pb}}^{\circ} - V_{\text{Zn}}^{\circ})}{\ln \frac{[\text{Zn}^{2+}]}{[\text{Pb}^{2+}]}} \right]$$

The standard potentials from Table 17.1 are  $V_{\text{Zn}}^{\circ} = -0.763 \text{ V}$  and  $V_{\text{Pb}}^{\circ} = -0.126 \text{ V}$ . Therefore,

$$T = - \frac{(2)(96,500 \text{ C/mol})}{8.31 \text{ J/mol-K}} \left[ \frac{0.568 \text{ V} - (-0.126 \text{ V} + 0.763 \text{ V})}{\ln \left( \frac{10^{-2} \text{ M}}{10^{-4} \text{ M}} \right)} \right]$$



$$= 348 \text{ K} = 75^\circ\text{C}$$

17.9 We are asked to modify Equation (17.19) for the case when metals  $M_1$  and  $M_2$  are alloys. In this case, the equation becomes

$$\Delta V = (V_2^\circ - V_1^\circ) - \frac{RT}{nF} \ln \frac{[M_1^{n+}][M_2]}{[M_2^{n+}][M_1]}$$

where  $[M_1]$  and  $[M_2]$  are the concentrations of metals  $M_1$  and  $M_2$  in their respective alloys.

17.10 This problem asks, for several pairs of alloys that are immersed in seawater, to predict whether or not corrosion is possible, and if it is possible, to note which alloy will corrode. In order to make these predictions it is necessary to use the galvanic series, Table 17.2. If both of the alloys in the pair reside within the same set of brackets in this table, then galvanic corrosion is unlikely. However, if the two alloys do not reside within the same set of brackets, then that alloy appearing lower in the table will experience corrosion.

- (a) For the aluminum-magnesium couple, corrosion is possible, and magnesium will corrode.
- (b) For the zinc-low carbon steel couple, corrosion is possible, and zinc will corrode.
- (c) For the brass-monel couple, corrosion is unlikely inasmuch as both alloys appear within the same set of brackets.
- (d) For the titanium-304 stainless steel pair, the stainless steel will corrode, inasmuch as it is below titanium in both its active and passive states.
- (e) For the cast iron-316 stainless steel couple, the cast iron will corrode since it is below stainless steel in both active and passive states.

17.11 (a) The following metals and alloys may be used to galvanically protect 304 stainless steel in the active state: cast iron, iron, steel, aluminum alloys, cadmium, commercially pure aluminum, zinc, magnesium, and magnesium alloys.

- (b) Zinc and magnesium may be used to protect a copper-aluminum galvanic couple.

17.12 This problem is just an exercise in unit conversions. The parameter **K** in Equation (17.23) must convert the units of **W**, **p**, **A**, and **t**, into the unit scheme for the **CPR**.

For **CPR** in mpy (mil/yr)

$$K = \frac{W(\text{mg})(1 \text{ g}/1000 \text{ mg})}{\rho \left( \frac{\text{g}}{\text{cm}^3} \right) \left( \frac{2.54 \text{ cm}}{\text{in.}} \right)^3 [A(\text{in.}^2)] \left( \frac{1 \text{ in.}}{1000 \text{ mil}} \right) [t(\text{h})] \left( \frac{1 \text{ day}}{24 \text{ h}} \right) \left( \frac{1 \text{ yr}}{365 \text{ days}} \right)}$$

$$= 534.6$$

For **CPR** in mm/yr

$$K = \frac{W(\text{mg})(1 \text{ g}/1000 \text{ mg})}{\rho \left( \frac{\text{g}}{\text{cm}^3} \right) \left( \frac{1 \text{ cm}}{10 \text{ mm}} \right)^3 [A(\text{cm}^2)] \left( \frac{10 \text{ mm}}{\text{cm}} \right)^2 [t(\text{h})] \left( \frac{1 \text{ day}}{24 \text{ h}} \right) \left( \frac{1 \text{ yr}}{365 \text{ days}} \right)}$$

$$= 87.6$$

17.13 This problem calls for us to compute the time of submersion of a steel piece. In order to solve this problem, we must first rearrange Equation (17.23), as

$$t = \frac{KW}{\rho A(\text{CPR})}$$

Thus,

$$t = \frac{(534)(2.6 \times 10^6 \text{ mg})}{(7.9 \text{ g}/\text{cm}^3)(10 \text{ in.}^2)(200 \text{ mpy})}$$

$$= 8.8 \times 10^4 \text{ h} = 10 \text{ yr}$$

17.14 This problem asks for us to calculate the **CPR** in both mpy and mm/yr for a thick steel sheet of area 100 in.<sup>2</sup> which experiences a weight loss of 485 g after one year. Employment of Equation (17.23) leads to

$$\text{CPR} = \frac{KW}{\rho A t}$$

$$= \frac{(87.6)(485 \text{ g})(10^3 \text{ mg}/\text{g})}{(7.9 \text{ g}/\text{cm}^3)(100 \text{ in.}^2)(2.54 \text{ cm}/\text{in.})^2(24 \text{ h}/\text{day})(365 \text{ day}/\text{yr})(1 \text{ yr})}$$

$$= 0.952 \text{ mm}/\text{yr}$$

Also

$$\text{CPR} = \frac{(534)(485 \text{ g})(10^3 \text{ mg/g})}{(7.9 \text{ g/cm}^3)(100 \text{ in.}^2)(24 \text{ h/day})(365 \text{ day/yr})(1 \text{ yr})}$$

$$= 37.4 \text{ mpy}$$

17.15 (a) We are to demonstrate that the **CPR** is related to the corrosion current density,  $i$ , in  $\text{A/cm}^2$  through the expression

$$\text{CPR} = \frac{K A i}{n \rho}$$

in which  $K$  is a constant,  $A$  is the atomic weight,  $n$  is the number of electrons ionized per metal atom, and  $\rho$  is the density of the metal. Possibly the best way to make this demonstration is by using a unit dimensional analysis. The corrosion rate,  $r$ , in Equation (17.24) has the units (SI)

$$r = \frac{i}{nF} = \frac{\text{C/m}^2 \cdot \text{s}}{(\text{unitless})(\text{C/mol})} = \frac{\text{mol}}{\text{m}^2 \cdot \text{s}}$$

The units of **CPR** in Equation (17.23) are length/time, or in the SI scheme,  $\text{m/s}$ . In order to convert the above expression to the units of  $\text{m/s}$  it is necessary to multiply  $r$  by the atomic weight  $A$  and divide by the density  $\rho$  as

$$\frac{rA}{\rho} = \frac{(\text{mol/m}^2 \cdot \text{s})(\text{g/mol})}{\text{g/m}^3} = \text{m/s}$$

Thus, the **CPR** is proportional to  $r$ , and substituting for  $r$  from Equation (17.24) into the above expression leads to

$$\text{CPR} = K'' r = \frac{K' A i}{n F \rho}$$

in which  $K'$  and  $K''$  are constants which will give the appropriate units for **CPR**. Also, since  $F$  is also a constant, this expression takes the form

$$\text{CPR} = \frac{K i}{n \rho}$$

in which  $K = K'/F$ .

(b) Now we will calculate the value of  $K$  in order to give the **CPR** in mpy for  $i$  in  $\mu\text{A}/\text{cm}^2$  ( $10^{-6} \text{ A}/\text{cm}^2$ ). It should be noted that the units of  $A$  (amperes) are  $\text{C}/\text{s}$ . Substitution of the units normally used into the former **CPR** expression above leads to

$$\begin{aligned} \text{CPR} &= K' \frac{A i}{n F \rho} \\ &= K' \frac{(\text{g/mol})(\text{C/s} \cdot \text{cm}^2)}{(\text{unitless})(\text{C/mol})(\text{g/cm}^3)} = \text{cm/s} \end{aligned}$$

Since we want the **CPR** in mpy and  $i$  is given in  $\mu\text{A}/\text{cm}^2$ , and realizing that  $K = K'/F$  leads to

$$\begin{aligned} K &= \left( \frac{1}{96,500 \text{ C/mol}} \right) \left( \frac{10^{-6} \text{ C}}{\mu\text{C}} \right) \left( \frac{1 \text{ in.}}{2.54 \text{ cm}} \right) \left( \frac{10^3 \text{ mil}}{\text{in.}} \right) \left( \frac{3.1536 \times 10^7 \text{ s}}{\text{yr}} \right) \\ &= 0.129 \end{aligned}$$

17.16 We are asked to compute the **CPR** in mpy for the corrosion of Fe for a corrosion current density of  $8 \times 10^{-5} \text{ A}/\text{cm}^2$  ( $80 \mu\text{A}/\text{cm}^2$ ). From Problem 17.15, the value of  $K$  in Equation (17.35) is 0.129, and therefore

$$\begin{aligned} \text{CPR} &= \frac{K i}{n \rho} \\ &= \frac{(0.129)(55.85 \text{ g/mol})(80 \mu\text{A}/\text{cm}^2)}{(2)(7.9 \text{ g/cm}^3)} = 36.5 \text{ mpy} \end{aligned}$$

17.17W (a) Activation polarization is the situation wherein a reaction rate is controlled by one step in a series of steps that takes place at the slowest rate. For corrosion, activation polarization is possible for both oxidation and reduction reactions. Concentration polarization occurs when a reaction rate is limited by diffusion in a solution. For corrosion, concentration polarization is possible only for reduction reactions.

(b) Activation polarization is rate controlling when the reaction rate is low and/or the concentration of active species in the liquid solution is high.

(c) Concentration polarization is rate controlling when the reaction rate is high and/or the concentration of active species in the liquid solution is low.

17.18W (a) The phenomenon of dynamic equilibrium is the state wherein oxidation and reduction reactions are occurring at the same rate such that there is no net observable reaction.

(b) The exchange current density is just the current density which is related to both the rates of oxidation and reduction (which are equal) according to Equation (17.24) for the dynamic equilibrium state.

17.19W Concentration polarization is not normally rate controlling for oxidation reactions because there will always be an unlimited supply of metal atoms at the corroding electrode interface.

17.20W (a) This portion of the problem asks that we compute the rate of oxidation for Ni given that both the oxidation and reduction reactions are controlled by activation polarization, and also given the polarization data for both nickel oxidation and hydrogen reduction. The first thing necessary is to establish relationships of the form of Equation (17.1W) for the potentials of both oxidation and reduction reactions. Next we will set these expressions equal to one another, and then solve for the value of  $i$  which is really the corrosion current density,  $i_c$ . Finally, the corrosion rate may be calculated using Equation (17.24). The two potential expressions are as follows:

For hydrogen reduction

$$V_H = V_{(H^+/H_2)} + \beta_H \log \left( \frac{i}{i_{o_H}} \right)$$

And for Ni oxidation

$$V_{Ni} = V_{(Ni/Ni^{2+})} + \beta_{Ni} \log \left( \frac{i}{i_{o_{Ni}}} \right)$$

Setting  $V_H = V_{Ni}$  and solving for  $\log i$  ( $\log i_c$ ) leads to

$$\log i_c = \left( \frac{1}{\beta_{Ni} - \beta_H} \right) \left[ V_{(H^+/H_2)} - V_{(Ni/Ni^{2+})} - \beta_H \log i_{o_H} + \beta_{Ni} \log i_{o_{Ni}} \right]$$

$$= \left[ \frac{1}{0.12 - (-0.10)} \right] \left[ 0 - (-0.25) - (-0.10) \left\{ \log(6 \times 10^{-7}) \right\} + (0.12) \left\{ \log(10^{-8}) \right\} \right]$$

$$= -6.055$$

Or

$$i_c = 10^{-6.055} = 8.81 \times 10^{-7} \text{ A/cm}^2$$

And from Equation (17.24)

$$r = \frac{i_c}{nF}$$

$$= \frac{8.81 \times 10^{-7} \text{ C/s} \cdot \text{cm}^2}{(2)(96,500 \text{ C/mol})} = 4.56 \times 10^{-12} \text{ mol/cm}^2 \cdot \text{s}$$

(b) Now it becomes necessary to compute the value of the corrosion potential,  $V_c$ . This is possible by using either of the above equations for  $V_H$  or  $V_{Ni}$  and substituting for  $i$  the value determined above for  $i_c$ . Thus

$$V_c = V_{(H^+/H_2)} + \beta_H \log \left( \frac{i_c}{i_{oH}} \right)$$

$$= 0 + (-0.10 \text{ V}) \log \left( \frac{8.81 \times 10^{-7} \text{ A/cm}^2}{6 \times 10^{-7} \text{ A/cm}^2} \right) = -0.0167 \text{ V}$$

17.21W (a) This portion of the problem asks that we compute the rate of oxidation for a divalent metal M given that both the oxidation and reduction reactions are controlled by activation polarization, and also given the polarization data for both M oxidation and hydrogen reduction. The first thing necessary is to establish relationships of the form of Equation (17.1W) for the potentials of both oxidation and reduction reactions. Next we will set these expressions equal to one another, and then solve for the value of  $i$  which is really the corrosion current density,  $i_c$ . Finally, the corrosion rate may be calculated using Equation (17.24). The two potential expressions are as follows:

For hydrogen reduction

$$V_H = V_{(H^+/H_2)} + \beta_H \log \left( \frac{i}{i_{o_H}} \right)$$

And for M oxidation

$$V_M = V_{(M/M^{2+})} + \beta_M \log \left( \frac{i}{i_{o_M}} \right)$$

Setting  $V_H = V_M$  and solving for  $\log i$  ( $\log i_c$ ) leads to

$$\begin{aligned} \log i_c &= \left( \frac{1}{\beta_M - \beta_H} \right) \left[ V_{(H^+/H_2)} - V_{(M/M^{2+})} - \beta_H \log i_{o_H} + \beta_M \log i_{o_M} \right] \\ &= \left[ \frac{1}{0.10 - (-0.15)} \right] \left[ 0 - (-0.90) - (-0.15) \left\{ \log (10^{-10}) \right\} + (0.10) \left\{ \log (10^{-12}) \right\} \right] \\ &= -7.20 \end{aligned}$$

Or

$$i_c = 10^{-7.20} = 6.31 \times 10^{-8} \text{ A/cm}^2$$

And from Equation (17.24)

$$\begin{aligned} r &= \frac{i_c}{nF} \\ &= \frac{6.31 \times 10^{-8} \text{ C/s} \cdot \text{cm}^2}{(2)(96,500 \text{ C/mol})} = 3.27 \times 10^{-13} \text{ mol/cm}^2 \cdot \text{s} \end{aligned}$$

(b) Now it becomes necessary to compute the value of the corrosion potential,  $V_c$ . This is possible by using either of the above equations for  $V_H$  or  $V_M$  and substituting for  $i$  the value determined above for  $i_c$ . Thus

$$V_c = V_{(H^+/H_2)} + \beta_H \log \left( \frac{i_c}{i_{o_H}} \right)$$

$$= 0 + (-0.15 \text{ V}) \log \left( \frac{6.31 \times 10^{-8} \text{ A/cm}^2}{10^{-10} \text{ A/cm}^2} \right) = -0.420 \text{ V}$$

17.22W This problem asks that we make a schematic plot of corrosion rate versus solution velocity. The reduction reaction is controlled by combined activation-concentration polarization for which the overvoltage versus logarithm current density is shown in Figure 17.21. The oxidation of the metal is controlled by activation polarization, such that the electrode kinetic behavior for the combined reactions would appear schematically as shown below.

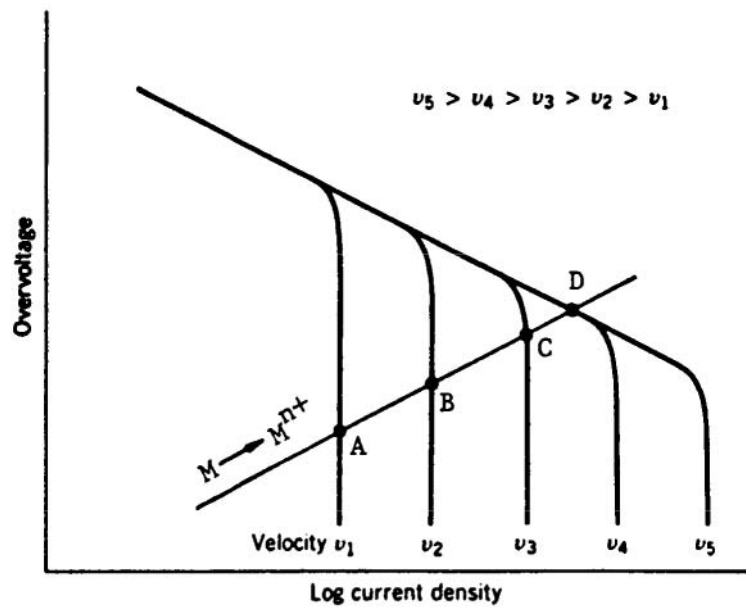

Thus, the plot of corrosion rate versus solution velocity would be as

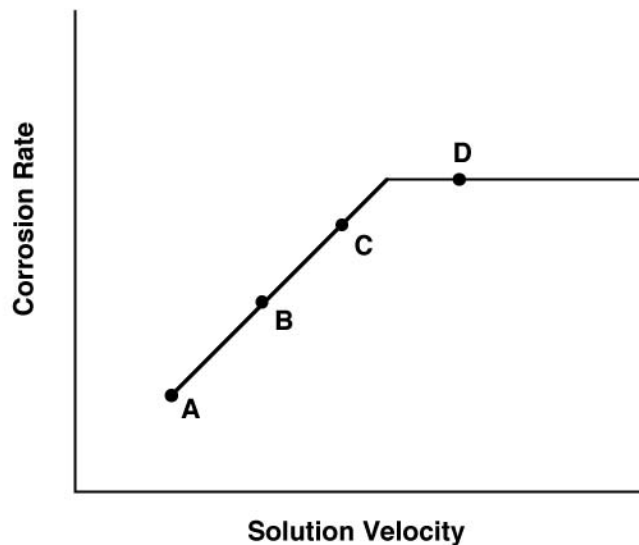



The corrosion rate initially increases with increasing solution velocity (for velocities  $v_1$ ,  $v_2$ , and  $v_3$ ), corresponding to intersections in the concentration polarization regions for the reduction reaction. However, for the higher solution velocities ( $v_4$  and  $v_5$ ), the metal oxidation line intersects the reduction reaction curve in the linear activation polarization region, and, thus, the reaction becomes independent of solution velocity.

17.23 Passivity is the loss of chemical reactivity, under particular environmental conditions, of normally active metals and alloys. Stainless steels and aluminum alloys often passivate.

17.24 The chromium in stainless steels causes a very thin and highly adherent surface coating to form over the surface of the alloy, which protects it from further corrosion. For plain carbon steels, rust, instead of this adherent coating, forms.

17.25 For each of the forms of corrosion, the conditions under which it occurs, and measures that may be taken to prevent or control it are outlined in Section 17.7.

17.26 Two beneficial uses of galvanic corrosion are corrosion prevention by means of cathodic protection, and the dry-cell battery.

17.27 Cold-worked metals are more susceptible to corrosion than noncold-worked metals because of the increased dislocation density for the latter. A region in the vicinity of a dislocation that intersects the surface is at a higher energy state, and, therefore, is more readily attacked by a corrosive solution.

17.28 For a small anode-to-cathode area ratio, the corrosion rate will be higher than for a large ratio. The reason for this is that for some given current flow associated with the corrosion reaction, for a small area ratio the current density at the anode will be greater than for a large ratio. The corrosion rate is proportional to the current density according to Equation (17.24).

17.29 For a concentration cell, corrosion occurs at that region having the lower concentration. In order to explain this phenomenon let us consider an electrochemical cell consisting of two divalent metal M electrodes each of which is immersed in a solution containing a different concentration of its  $M^{2+}$  ion; let us designate the low and high concentrations of  $M^{2+}$  as  $[M_L^{2+}]$  and  $[M_H^{2+}]$ , respectively. Now assuming that reduction and oxidation reactions occur in the high- and low-concentration solutions, respectively, let us determine the cell potential in terms of the two  $[M^{2+}]$ 's; if this potential

is positive then we have correctly chosen the solutions in which the reduction and oxidation reactions occur.

Thus, the two half-reactions in the form of Equations (17.16) are

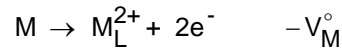
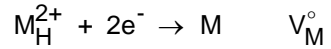

Whereas the overall cell reaction is

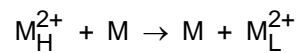

From Equation (17.19), this yields a cell potential of

$$\begin{aligned} \Delta V &= V_M^\circ - V_M^\circ - \frac{RT}{nF} \ln \left( \frac{[M_L^{2+}]}{[M_H^{2+}]} \right) \\ &= - \frac{RT}{nF} \ln \left( \frac{[M_L^{2+}]}{[M_H^{2+}]} \right) \end{aligned}$$

Inasmuch as  $M_L^{2+} < M_H^{2+}$  then the natural logarithm of the  $[M^{2+}]$  ratio is negative, which yields a positive value for  $\Delta V$ . This means that the electrochemical reaction is spontaneous as written, or that oxidation occurs at the electrode having the lower  $M^{2+}$  concentration.

17.30 Equation (17.23) is **not** equally valid for uniform corrosion and pitting. The reason for this is that, with pitting, the corrosion attack is very localized, and a pit may penetrate the entire thickness of a piece (leading to failure) with very little material loss and a very small corrosion penetration rate. With uniform corrosion, the corrosion penetration rate accurately represents the extent of corrosion damage.

17.31 (a) Inhibitors are substances that, when added to a corrosive environment in relatively low concentrations, decrease the environment's corrosiveness.

(b) Possible mechanisms that account for the effectiveness of inhibitors are: 1) elimination of a chemically active species in the solution; 2) attachment of inhibitor molecules to the corroding

surface so as to interfere with either the oxidation or reduction reaction; and 3) the formation of a very thin and protective coating on the corroding surface.

17.32 Descriptions of the two techniques used for galvanic protection are as follows:

1) A sacrificial anode is electrically coupled to the metal piece to be protected, which anode is also situated in the corrosion environment. The sacrificial anode is a metal or alloy that is chemically more reactive in the particular environment. It (the anode) preferentially oxidizes, and, upon giving up electrons to the other metal, protects it from electrochemical corrosion.

2) An impressed current from an external dc power source provides excess electrons to the metallic structure to be protected.

17.33 Tin offers galvanic protection to the steel in tin cans even though it (tin) is electrochemically less active than steel from the galvanic series. The reason for this is that the galvanic series represents the reactivities of metals and alloys in seawater; however, for the food solutions that are contained within the cans, tin is the more active metal.

17.34 For this problem we are given, for three metals, their densities, oxide chemical formulas, and oxide densities, and are asked to compute the Pilling-Bedworth ratios, and then to specify whether or not the oxide scales that form will be protective. The general form of the equation used to calculate this ratio is Equation (17.30) [or Equation (17.29)]. For magnesium, oxidation occurs by the reaction

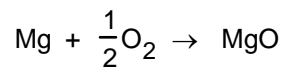

and therefore, from Equation (17.29)

$$\begin{aligned} \text{P-B ratio} &= \frac{A_{\text{MgO}}\rho_{\text{Mg}}}{A_{\text{Mg}}\rho_{\text{MgO}}} \\ &= \frac{(40.31 \text{ g/mol})(1.74 \text{ g/cm}^3)}{(24.31 \text{ g/mol})(3.58 \text{ g/cm}^3)} = 0.81 \end{aligned}$$

Thus, this would probably be a nonprotective oxide film since the P-B ratio is less than unity; to be protective, this ratio should be between one and two.

The oxidation reaction for V is just

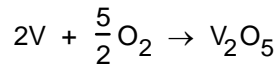

and the P-B ratio is [Equation (17.30)]

$$\begin{aligned} \text{P-B ratio} &= \frac{A_{V_2O_5} \rho_V}{(2)A_V \rho_{V_2O_5}} \\ &= \frac{(181.88 \text{ g/mol})(6.11 \text{ g/cm}^3)}{(2)(50.94 \text{ g/mol})(3.36 \text{ g/cm}^3)} = 3.25 \end{aligned}$$

Hence, the film would be nonprotective since the ratio does not lie between one and two.

Now for Zn, the reaction for its oxidation is analogous to that for Mg above. Therefore,

$$\begin{aligned} \text{P-B ratio} &= \frac{A_{ZnO} \rho_{Zn}}{A_{Zn} \rho_{ZnO}} \\ &= \frac{(81.39 \text{ g/mol})(7.13 \text{ g/cm}^3)}{(65.39 \text{ g/mol})(5.61 \text{ g/cm}^3)} = 1.58 \end{aligned}$$

Thus, the ZnO film would probably be protective since the ratio is between one and two.

17.35 Silver does not oxidize appreciably at room temperature and in air even though, according to Table 17.3, the oxide coating should be nonprotective because the oxidation of silver in air is not thermodynamically favorable; therefore, the lack of a reaction is independent of whether or not a protective scale forms.

17.36 For this problem we are given weight gain-time data for the oxidation of Ni at an elevated temperature.

(a) We are first asked to determine whether the oxidation kinetics obey a parabolic, linear, or logarithmic rate expression, which expressions are represented by Equations (17.31), (17.32), and (17.33), respectively. One way to make this determination is by trial and error. Let us assume that the parabolic relationship is valid; that is from Equation (17.31)

$$W^2 = K_1 t + K_2$$

which means that we may establish three simultaneous equations using the three sets of given **W** and **t** values, then using two combinations of two pairs of equations, solve for **K<sub>1</sub>** and **K<sub>2</sub>**; if **K<sub>1</sub>** and **K<sub>2</sub>** have the same values for both solutions, then the kinetics are parabolic. If the values are not identical then the other kinetic relationships need to be explored. Thus, the three equations are

$$\begin{aligned}(0.527)^2 &= 0.278 = 10K_1 + K_2 \\ (0.857)^2 &= 0.734 = 30K_1 + K_2 \\ (1.526)^2 &= 2.329 = 100K_1 + K_2\end{aligned}$$

From the first two equations **K<sub>1</sub>** = 0.0228 and **K<sub>2</sub>** = 0.050; these same two values are obtained using the last two equations. Hence, the oxidation rate law is parabolic.

(b) Since a parabolic relationship is valid, this portion of the problem calls for us to determine **W** after a total time of 600 min. Again, using Equation (17.31) and the values of **K<sub>1</sub>** and **K<sub>2</sub>**

$$\begin{aligned}W^2 &= K_1t + K_2 \\ &= (0.0228)(600 \text{ min}) + 0.05 = 13.37\end{aligned}$$

$$\text{Or } W = \sqrt{13.73} = 3.70 \text{ mg/cm}^2.$$

16.37 For this problem we are given weight gain-time data for the oxidation of some metal at an elevated temperature.

(a) We are first asked to determine whether the oxidation kinetics obey a linear, parabolic, or logarithmic rate expression, which expressions are described by Equations (17.32), (17.31), and (17.33), respectively. One way to make this determination is by trial and error. Let us assume that the rate expression is parabolic, that is from Equation (17.31)

$$W^2 = K_1t + K_2$$

which means that we may establish three simultaneous equations using the three sets of given **W** and **t** values, then using two combinations of two pairs of equations, solve for **K<sub>1</sub>** and **K<sub>2</sub>**; if **K<sub>1</sub>** and **K<sub>2</sub>** have the same values for both solutions, then the rate law is parabolic. If the values are not the same then the other kinetic relationships need to be explored. Thus, the three equations are

$$\begin{aligned}(6.16)^2 &= 37.95 = 100K_1 + K_2 \\ (8.59)^2 &= 73.79 = 250K_1 + K_2\end{aligned}$$

$$(12.72)^2 = 161.8 = 1000K_1 + K_2$$

From the first two equations  $K_1 = 0.238$  and  $K_2 = 14.2$ ; while from the second and third equations  $K_1 = 0.117$  and  $K_2 = 44.5$ . Thus, a parabolic rate expression is not obeyed by this reaction.

Let us now investigate linear kinetics in the same manner, using Equation (17.32),  $W = K_3t$ .

The three equations are thus

$$6.16 = 100 K_3$$

$$8.59 = 250 K_3$$

$$12.72 = 1000 K_3$$

And the three  $K_3$  values may be computed (one for each equation) which are  $6.16 \times 10^{-2}$ ,  $3.44 \times 10^{-2}$ , and  $1.272 \times 10^{-2}$ . Since these  $K_3$  values are all different, a linear rate law is not a possibility, and, by process of elimination, a logarithmic expression is obeyed.

(b) In order to determine the value of  $W$  after 5000 min, it is first necessary that we solve for the  $K_4$ ,  $K_5$ , and  $K_6$  constants of Equation (17.33). One way this may be accomplished is to use the **E-Z Solve** equation solver, with Equation (17.33) expressed in exponential form, as

$$K_5 + K_6 = 10^{W/K_4}$$

The following is entered into the workspace of **E-Z Solve**

$$K_5 * t_1 + K_6 = 10^{(W_1/K_4)}$$

$$K_5 * t_2 + K_6 = 10^{(W_2/K_4)}$$

$$K_5 * t_3 + K_6 = 10^{(W_3/K_4)}$$

$$t_1 = 100; \quad W_1 = 6.16$$

$$t_2 = 250; \quad W_2 = 8.59$$

$$t_3 = 1000; \quad W_3 = 12.72$$

After choosing the calculator icon in the menu bar, and clicking on the "Solve" button in the window that appears (with "1" as the guess value for all three of  $K_4$ ,  $K_5$ , and  $K_6$ ), the following values for the three constants are displayed in the data grid near the bottom of the window:

$$K_4 = 7.305$$

$$K_5 = 0.0535$$

$$K_6 = 1.622$$

Now solving Equation (17.33) for  $W$  at a time of 5000 min

$$\begin{aligned} W &= K_4 \log (K_5 t + K_6) \\ &= 7.305 \log [(0.0535)(5000 \text{ min}) + 1.622] \\ &= 17.75 \text{ mg/cm}^2 \end{aligned}$$

17.38 For this problem we are given weight gain-time data for the oxidation of some metal at an elevated temperature.

(a) We are first asked to determine whether the oxidation kinetics obey a linear, parabolic, or logarithmic rate expression, which expressions are described by Equations (17.32), (17.31), and (17.33), respectively. One way to make this determination is by trial and error. Let us assume that the rate expression is linear, that is from Equation (17.32)

$$W = K_3 t$$

which means that we may establish three simultaneous equations using the three sets of given  $W$  and  $t$  values, then solve for  $K_3$  for each; if  $K_3$  is the same for all three cases, then the rate law is linear. If the values are not the same then the other kinetic relationships need to be explored. Thus, the three equations are

$$\begin{aligned} 1.54 &= 10K_3 \\ 23.24 &= 150K_3 \\ 95.37 &= 620K_3 \end{aligned}$$

In all three instances the value of  $K_3$  is about equal to 0.154, which means the oxidation rate obeys a linear expression.

(b) Now we are to calculate **W** after a time of 1200 min; thus

$$W = K_3 t = (0.154)(1200 \text{ min}) = 184.80 \text{ mg/cm}^2$$

17.39 During the swelling and dissolution of polymeric materials, the solute molecules diffuse to and occupy positions among the polymer macromolecules, and thereby force the latter apart. Increasing both the degrees of crosslinking and crystallinity will enhance a polymer's resistance to these types of degradation since there will be a greater degree of intermolecular bonding between adjacent chains; this restricts the number of solute molecules that can fit into these locations.

Crosslinking will be more effective. For linear polymers, the intermolecular bonds are secondary ones (van der Waals and/or hydrogen), and relatively weak in comparison to the strong covalent bonds associated with the crosslinks.

17.40 (a) Three differences between the corrosion of metals and the corrosion of ceramics are:

- 1) Ceramic materials are more corrosion resistant than metals in most environments.
- 2) Corrosion of ceramic materials is normally just a chemical dissolution process, whereas for metals it is usually electrochemical.
- 3) Ceramics are more corrosion resistant at elevated temperatures.

(b) Three differences between the corrosion of metals and the degradation of polymers are:

- 1) Degradation of polymers is ordinarily physiochemical, whereas for metals, corrosion is electrochemical.
- 2) Degradation mechanisms for polymers are more complex than the corrosion mechanisms for metals.
- 3) More types of degradation are possible for polymers--e.g., dissolution, swelling, and bond rupture (by means of radiation, heat, and chemical reactions).

### Design Problems

17.D1 Possible methods that may be used to reduce corrosion of the heat exchanger by the brine are as follows:

- 1) Reduce the temperature of the brine; normally, the rate of a corrosion reaction increases with increasing temperature.
- 2) Change the composition of the brine; the corrosion rate is often quite dependent on the composition of the corrosion environment.



- 3) Remove as much dissolved oxygen as possible. Under some circumstances, the dissolved oxygen may form bubbles, which can lead to erosion-corrosion damage.
- 4) Minimize the number of bends and/or changes in pipe contours in order to minimize erosion-corrosion.
- 5) Add inhibitors.
- 6) Avoid connections between different metal alloys.

17.D2 This question asks that we suggest appropriate materials, and if necessary, recommend corrosion prevention measures that should be taken for several specific applications. These are as follows:

(a) Laboratory bottles to contain relatively dilute solutions of nitric acid. Probably the best material for this application would be polytetrafluoroethylene (PTFE). The reasons for this are: 1) it is flexible and will not easily break if dropped; and 2) PTFE is resistant to this type of acid, as noted in Table 17.4.

(b) Barrels to contain benzene. Polyethylene terephthalate (PET) would be suited for this application, since it is resistant to degradation by benzene (Table 17.4), and is less expensive than the other two materials listed in Table 17.4 (see Appendix C).

(c) Pipe to transport hot alkaline (basic) solutions. The best material for this application would probably be a nickel alloy (Section 11.3). Polymeric materials listed in Table 17.4 would not be suitable inasmuch as the solutions are hot.

(d) Underground tanks to store large quantities of high purity water. The outside of the tanks should probably be some type of low-carbon steel that is cathodically protected (Sections 17.8 and 17.9). The inside of this steel shell should be coated with an inert polymeric material; polytetrafluoroethylene or some other fluorocarbon would probably be the material of choice (Table 17.4).

(e) Architectural trim for high-rise buildings. The most likely candidate for this application would probably be an aluminum alloy. Aluminum and its alloys are relatively corrosion resistant in normal atmospheres (Section 17.8), retains their lustrous appearance, and are relatively inexpensive (Appendix C).

17.D3 (a) Advantages of delivering drugs into the body using transdermal patches (as opposed to oral administration) are: 1) Drugs that are taken orally must pass through the digestive system and, consequently, may cause digestive discomfort. 2) Orally delivered drugs will ultimately pass through the liver which function is to filter out of the blood unnatural substances, including some drugs; thus, drug concentrations in the blood are diluted. 3) It is much easier to maintain a constant level of delivery over relatively long time periods using transdermal patches.

(b) In order for transdermal delivery, the skin must be permeable to the drug, or delivery agents must be available that can carry the drug through the skin.

(c) Characteristics that are required for transdermal patch materials are the following: they must be flexible; they must adhere to the skin; they must not cause skin irritation; they must be permeable to the drug; and they must not interact with the drug over long storage periods.

17.D4 Each student or group of students is to submit their own report on a corrosion problem investigation that was conducted.

CHAPTER 18

**ELECTRICAL PROPERTIES**

PROBLEM SOLUTIONS

18.1 This problem calls for us to compute the electrical conductivity and resistance of a silicon specimen.

(a) We use Equations (18.3) and (18.4) for the conductivity, as

$$\begin{aligned}\sigma &= \frac{1}{\rho} = \frac{Il}{VA} = \frac{Il}{V\pi\left(\frac{d}{2}\right)^2} \\ &= \frac{(0.1 \text{ A})(38 \times 10^{-3} \text{ m})}{(12.5 \text{ V})(\pi)\left(\frac{5.1 \times 10^{-3} \text{ m}}{2}\right)^2} = 14.9 \text{ } (\Omega \cdot \text{m})^{-1}\end{aligned}$$

(b) The resistance,  $R$ , may be computed using Equations (18.2) and (18.4), as

$$\begin{aligned}R &= \frac{l}{\sigma A} \\ &= \frac{51 \times 10^{-3} \text{ m}}{\left[14.9 \text{ } (\Omega \cdot \text{m})^{-1}\right](\pi)\left(\frac{5.1 \times 10^{-3} \text{ m}}{2}\right)^2} = 166.9 \text{ } \Omega\end{aligned}$$

18.2 For this problem, given that an aluminum wire 10 m long must experience a voltage drop of less than 1 V when a current of 5 A passes through it, we are to compute the minimum diameter of the wire. Combining Equations (18.3) and (18.4) and solving for the cross-sectional area  $A$  leads to

$$A = \frac{Il}{V\sigma}$$

From Table 18.1, for aluminum  $\sigma = 3.8 \times 10^7 \text{ } (\Omega \cdot \text{m})^{-1}$ . Furthermore, inasmuch as  $A = \pi\left(\frac{d}{2}\right)^2$  for a cylindrical wire, then

$$\pi \left(\frac{d}{2}\right)^2 = \frac{I l}{V \sigma}$$

or

$$d = \sqrt{\frac{4 I l}{\pi V \sigma}}$$

$$= \sqrt{\frac{(4)(5 \text{ A})(10 \text{ m})}{(\pi)(1 \text{ V})[3.8 \times 10^7 (\Omega \cdot \text{m})^{-1}]}}$$

$$= 1.3 \times 10^{-3} \text{ m} = 1.3 \text{ mm}$$

18.3 This problem asks that we compute, for a plain carbon steel wire 3 mm in diameter, the maximum length such that the resistance will not exceed 20  $\Omega$ . From Table 18.1, for a plain carbon steel,  $\sigma = 0.6 \times 10^7 (\Omega \cdot \text{m})^{-1}$ . If  $d$  is the diameter then, combining Equations (18.2) and (18.4) leads to

$$l = R \sigma A = R \sigma \pi \left(\frac{d}{2}\right)^2$$

$$= (20 \Omega) [0.6 \times 10^7 (\Omega \cdot \text{m})^{-1}] (\pi) \left(\frac{3 \times 10^{-3} \text{ m}}{2}\right)^2 = 848 \text{ m}$$

18.4 Let us demonstrate that, by appropriate substitution and algebraic manipulation, Equation (18.5) may be made to take the form of Equation (18.1). Now, Equation (18.5) is just

$$\mathbf{J} = \sigma \mathbf{E}$$

But, by definition,  $\mathbf{J}$  is just the current density, the current per unit cross-sectional area, or  $\mathbf{J} = \mathbf{I}/A$ . Also, the electric field is defined by  $\mathbf{E} = \mathbf{V}/l$ . And, substituting these expressions into Equation (18.5) leads to

$$\frac{\mathbf{I}}{A} = \sigma \frac{V}{l}$$

But, from Equations (18.2) and (18.4)

$$\sigma = \frac{1}{RA}$$

and

$$\frac{I}{A} = \left(\frac{1}{RA}\right) \left(\frac{V}{l}\right)$$

Solving for  $V$  from this expression gives  $V = IR$ , which is just Equation (18.1).

18.5 (a) In order to compute the resistance of this copper wire it is necessary to employ Equations (18.2) and (18.4). Solving for the resistance in terms of the conductivity,

$$R = \frac{\rho l}{A} = \frac{l}{\sigma A}$$

From Table 18.1, the conductivity of copper is  $6.0 \times 10^7 (\Omega\text{-m})^{-1}$ , and

$$\begin{aligned} R &= \frac{l}{\sigma A} = \frac{2 \text{ m}}{\left[6.0 \times 10^7 (\Omega\text{-m})^{-1}\right] \pi \left(\frac{3 \times 10^{-3} \text{ m}}{2}\right)^2} \\ &= 4.7 \times 10^{-3} \Omega \end{aligned}$$

(b) If  $V = 0.05 \text{ V}$  then, from Equation (18.1)

$$I = \frac{V}{R} = \frac{0.05 \text{ V}}{4.7 \times 10^{-3} \Omega} = 10.6 \text{ A}$$

(c) The current density is just

$$J = \frac{I}{A} = \frac{I}{\pi \left(\frac{d}{2}\right)^2} = \frac{10.6 \text{ A}}{\pi \left(\frac{3 \times 10^{-3} \text{ m}}{2}\right)^2} = 1.5 \times 10^6 \text{ A/m}^2$$

(d) The electric field is just

$$E = \frac{V}{l} = \frac{0.05 \text{ V}}{2 \text{ m}} = 2.5 \times 10^{-2} \text{ V/m}$$

18.6 When a current arises from a flow of electrons, the conduction is termed **electronic**; for **ionic conduction**, the current results from the net motion of charged ions.

18.7 For an isolated atom, there exist discrete electron energy states (arranged into shells and subshells); each state may be occupied by, at most, two electrons, which must have opposite spins. On the other hand, an electron band structure is found for solid materials; within each band exist closely spaced yet discrete electron states, each of which may be occupied by, at most, two electrons, having opposite spins. The number of electron states in each band will equal the total number of corresponding states contributed by all of the atoms in the solid.

18.8 This question asks that we explain the difference in electrical conductivity for metals, semiconductors, and insulators in terms of their electron energy band structures.

For metallic materials, there are vacant electron energy states adjacent to the highest filled state; thus, very little energy is required to excite large numbers of electrons into conducting states. These electrons are those that participate in the conduction process, and, because there are so many of them, metals are good electrical conductors.

There are no empty electron states adjacent to and above filled states for semiconductors and insulators, but rather, an energy band gap across which electrons must be excited in order to participate in the conduction process. Thermal excitation of electrons will occur, and the number of electrons excited will be less than for metals, and will depend on the band gap energy. For semiconductors, the band gap is narrower than for insulators; consequently, at a specific temperature more electrons will be excited for semiconductors, giving rise to higher conductivities.

18.9 The electrical conductivity for a metallic glass will be less than for its crystalline counterpart. The glass will have virtually no periodic atomic structure, and, as a result, electrons that are involved in the conduction process will experience frequent and repeated scattering. (There is no electron scattering in a perfect crystal lattice of atoms.)

18.10 The drift velocity of a free electron is the average electron velocity in the direction of the force imposed by an electric field.

The mobility is the proportionality constant between the drift velocity and the electric field. It is also a measure of the frequency of scattering events (and is inversely proportional to the frequency of scattering).

18.11 (a) The drift velocity of electrons in Ge may be determined using Equation (18.7). Since the room temperature mobility of electrons is  $0.38 \text{ m}^2/\text{V}\cdot\text{s}$  (Table 18.2), and the electric field is  $1000 \text{ V/m}$  (as stipulated in the problem),

$$\begin{aligned} v_d &= \mu_e E \\ &= (0.38 \text{ m}^2/\text{V}\cdot\text{s})(1000 \text{ V/m}) = 380 \text{ m/s} \end{aligned}$$

(b) The time,  $t$ , required to traverse a given length,  $l$ , of  $25 \text{ mm}$  is just

$$t = \frac{l}{v_d} = \frac{25 \times 10^{-3} \text{ m}}{380 \text{ m/s}} = 6.6 \times 10^{-5} \text{ s}$$

18.12 The conductivity of this semiconductor is computed using Equation (18.16). However, it first becomes necessary to determine the electron mobility from Equation (18.7) as

$$\mu_e = \frac{v_d}{E} = \frac{100 \text{ m/s}}{500 \text{ V/m}} = 0.20 \text{ m}^2/\text{V}\cdot\text{s}$$

Thus,

$$\begin{aligned} \sigma &= n|e|\mu_e \\ &= (3 \times 10^{18} \text{ m}^{-3})(1.602 \times 10^{-19} \text{ C})(0.20 \text{ m}^2/\text{V}\cdot\text{s}) \\ &= 0.096 (\Omega\cdot\text{m})^{-1} \end{aligned}$$

18.13 (a) The number of free electrons per cubic meter for copper at room temperature may be computed using Equation (18.8) as

$$\begin{aligned} n &= \frac{\sigma}{|e|\mu_e} \\ &= \frac{6.0 \times 10^7 (\Omega\cdot\text{m})^{-1}}{(1.602 \times 10^{-19} \text{ C})(0.0030 \text{ m}^2/\text{V}\cdot\text{s})} \\ &= 1.25 \times 10^{29} \text{ m}^{-3} \end{aligned}$$

(b) In order to calculate the number of free electrons per copper atom, we must first determine the number of copper atoms per cubic meter,  $N_{\text{Cu}}$ . From Equation (4.2)

$$N_{\text{Cu}} = \frac{N_A \rho}{A_{\text{Cu}}}$$

$$= \frac{(6.023 \times 10^{23} \text{ atoms/mol})(8.94 \text{ g/cm}^3)(10^6 \text{ cm}^3/\text{m}^3)}{63.55 \text{ g/mol}}$$

$$= 8.47 \times 10^{28} \text{ m}^{-3}$$

The number of free electrons per copper atom is just

$$\frac{n}{N} = \frac{1.25 \times 10^{29} \text{ m}^{-3}}{8.47 \times 10^{28} \text{ m}^{-3}} = 1.48$$

18.14 (a) This portion of the problem asks that we calculate, for silver, the number of free electrons per cubic meter ( $n$ ) given that there are 1.3 free electrons per silver atom, that the electrical conductivity is  $6.8 \times 10^7 (\Omega\text{-m})^{-1}$ , and that the density ( $\rho_{\text{Ag}}$ ) is  $10.5 \text{ g/cm}^3$ . (Note: in this discussion, the density of silver is represented by  $\rho_{\text{Ag}}$  in order to avoid confusion with resistivity which is designated by  $\rho$ .)

Since  $n = 1.3N$ , and  $N$  is defined in Equation (4.2), then

$$n = 1.3N = 1.3 \left[ \frac{\rho_{\text{Ag}} N_A}{A_{\text{Ag}}} \right]$$

$$= 1.3 \left[ \frac{(10.5 \text{ g/cm}^3)(6.023 \times 10^{23} \text{ atoms/mol})}{107.87 \text{ g/mol}} \right]$$

$$= 7.62 \times 10^{22} \text{ cm}^{-3} = 7.62 \times 10^{28} \text{ m}^{-3}$$

(b) Now we are asked to compute the electron mobility,  $\mu_e$ . Using Equation (18.8)

$$\mu_e = \frac{\sigma}{n|e|}$$



$$= \frac{6.8 \times 10^7 (\Omega \cdot \text{m})^{-1}}{(7.62 \times 10^{28} \text{ m}^{-3})(1.602 \times 10^{-19} \text{ C})} = 5.57 \times 10^{-3} \text{ m}^2/\text{V} \cdot \text{s}$$

18.15 We want to solve for the parameter **A** in Equation (18.11) using the data in Figure 18.26. From Equation (18.11)

$$A = \frac{\rho_i}{c_i(1 - c_i)}$$

However, the data plotted in Figure 18.26 is for the total resistivity,  $\rho_{\text{total}}$ , and includes both impurity ( $\rho_i$ ) and thermal ( $\rho_t$ ) contributions [Equation (18.9)]. The value of  $\rho_t$  is taken as the resistivity at  $c_i = 0$  in Figure 18.26, which has a value of  $1.7 \times 10^{-8}$  ( $\Omega \cdot \text{m}$ ); this must be subtracted out. Below are tabulated values of **A** determined at  $c_i = 0.10, 0.20,$  and  $0.30$ , including other data that were used in the computations.

$c_i$	$1 - c_i$	$\rho_{\text{total}}$ ( $\Omega \cdot \text{m}$ )	$\rho_i$ ( $\Omega \cdot \text{m}$ )	<b>A</b> ( $\Omega \cdot \text{m}$ )
0.10	0.90	$3.9 \times 10^{-8}$	$2.2 \times 10^{-8}$	$2.44 \times 10^{-7}$
0.20	0.80	$5.3 \times 10^{-8}$	$3.6 \times 10^{-8}$	$2.25 \times 10^{-7}$
0.30	0.70	$6.15 \times 10^{-8}$	$4.45 \times 10^{-8}$	$2.12 \times 10^{-7}$

There appears to be a slight decrease of **A** with increasing  $c_i$ .

18.16 (a) Perhaps the easiest way to determine the values of  $\rho_0$  and **a** in Equation (18.10) for pure copper in Figure 18.8, is to set up two simultaneous equations and use resistivity values at two different temperatures (labeled as **1** and **2**). Thus,

$$\rho_{t1} = \rho_0 + aT_1$$

$$\rho_{t2} = \rho_0 + aT_2$$

Solving these equations for **a** and  $\rho_0$  yield

$$a = \frac{\rho_{t1} - \rho_{t2}}{T_1 - T_2}$$

$$\begin{aligned}\rho_o &= \rho_{t1} - T_1 \left[ \frac{\rho_{t1} - \rho_{t2}}{T_1 - T_2} \right] \\ &= \rho_{t2} - T_2 \left[ \frac{\rho_{t1} - \rho_{t2}}{T_1 - T_2} \right]\end{aligned}$$

Let us take  $T_1 = -150^\circ\text{C}$ ,  $T_2 = -50^\circ\text{C}$ , which gives  $\rho_{t1} = 0.6 \times 10^{-8} \text{ } (\Omega\text{-m})$ , and  $\rho_{t2} = 1.25 \times 10^{-8} \text{ } (\Omega\text{-m})$ . Therefore

$$\begin{aligned}a &= \frac{\left[ (0.6 \times 10^{-8}) - (1.25 \times 10^{-8}) \right] (\Omega\text{-m})}{-150^\circ\text{C} - (-50^\circ\text{C})} \\ &= 6.5 \times 10^{-11} \text{ } (\Omega\text{-m})/^\circ\text{C}\end{aligned}$$

and

$$\begin{aligned}\rho_o &= (0.6 \times 10^{-8}) - (-150) \frac{\left[ (0.6 \times 10^{-8}) - (1.25 \times 10^{-8}) \right] (\Omega\text{-m})}{-150^\circ\text{C} - (-50^\circ\text{C})} \\ &= 1.58 \times 10^{-8} \text{ } (\Omega\text{-m})\end{aligned}$$

(b) For this part of the problem, we want to calculate **A** from Equation (18.11)—i.e.,

$$\rho_i = A c_i (1 - c_i)$$

In Figure 18.8, curves are plotted for three  $c_i$  values (0.0112, 0.0216, and 0.0332). Let us find **A** for each of these  $c_i$ 's by taking a  $\rho_{\text{total}}$  from each curve at some temperature (say  $0^\circ\text{C}$ ) and then subtracting out  $\rho_i$  for pure copper at this same temperature (which is  $1.7 \times 10^{-8} \text{ } \Omega\text{-m}$ ). Below are tabulated values of **A** determined from these three  $c_i$  values, and other data that were used in the computations.

$c_i$	$1 - c_i$	$\rho_{\text{total}} \text{ } (\Omega\text{-m})$	$\rho_i \text{ } (\Omega\text{-m})$	<b>A</b> $(\Omega\text{-m})$
0.0112	0.989	$3.0 \times 10^{-8}$	$1.3 \times 10^{-8}$	$1.17 \times 10^{-6}$
0.0216	0.978	$4.2 \times 10^{-8}$	$2.5 \times 10^{-8}$	$1.18 \times 10^{-6}$
0.0332	0.967	$5.5 \times 10^{-8}$	$3.8 \times 10^{-8}$	$1.18 \times 10^{-6}$

The average of these three **A** values is  $1.18 \times 10^{-6} \text{ } (\Omega\text{-m})$ .

(c) We use the results of parts (a) and (b) to estimate the electrical resistivity of copper containing 1.75 at% Ni at 100°C. The total resistivity is just

$$\begin{aligned} \rho_{\text{total}} &= \rho_t + \rho_i \\ &= (\rho_o + aT) + A c_i (1 - c_i) \\ &= \left\{ .58 \times 10^{-8} \text{ } (\Omega\text{-m}) + \left[ 6.5 \times 10^{-11} \text{ } (\Omega\text{-m}) / ^\circ\text{C} \right] (100^\circ\text{C}) \right\} \\ &\quad + \left\{ \left[ 1.18 \times 10^{-6} \text{ } (\Omega\text{-m}) \right] (0.0175)(1 - 0.0175) \right\} \\ &= 4.26 \times 10^{-8} \text{ } (\Omega\text{-m}) \end{aligned}$$

18.17 We are asked to determine the electrical conductivity of a Cu-Ni alloy that has a tensile strength of 275 MPa. From Figure 7.14(a), the composition of an alloy having this tensile strength is about 8 wt% Ni. For this composition, the resistivity is about  $13 \times 10^{-8} \text{ } \Omega\text{-m}$  (Figure 18.9). And since the conductivity is the reciprocal of the resistivity, Equation (18.4), we have

$$\sigma = \frac{1}{\rho} = \frac{1}{13 \times 10^{-8} \text{ } \Omega\text{-m}} = 7.7 \times 10^6 \text{ } (\Omega\text{-m})^{-1}$$

18.18 This problem asks for us to compute the room-temperature conductivity of a two-phase Cu-Sn alloy. It is first necessary for us to determine the volume fractions of the  $\alpha$  and  $\epsilon$  phases, after which the resistivity (and subsequently, the conductivity) may be calculated using Equation (18.12). Weight fractions of the two phases are first calculated using the phase diagram information provided in the problem.

We might represent the phase diagram near room temperature as shown below.

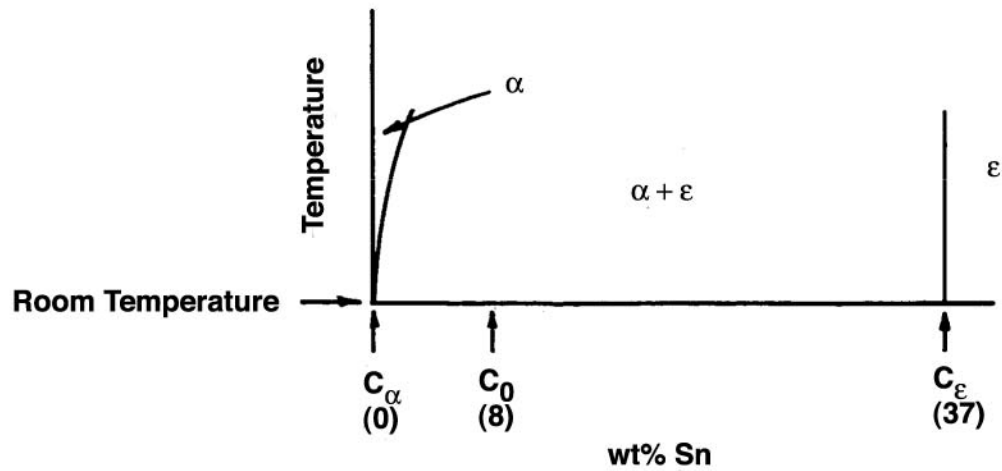

Applying the lever rule to this situation

$$W_{\alpha} = \frac{C_{\varepsilon} - C_0}{C_{\varepsilon} - C_{\alpha}} = \frac{37 - 11}{37 - 0} = 0.703$$

$$W_{\varepsilon} = \frac{C_0 - C_{\alpha}}{C_{\varepsilon} - C_{\alpha}} = \frac{11 - 0}{37 - 0} = 0.297$$

We must now convert these mass fractions into volume fractions using the phase densities given in the problem. (Note: in the following expressions, density is represented by  $\rho'$  in order to avoid confusion with resistivity which is designated by  $\rho$ .) Utilization of Equations (9.6a) and (9.6b) leads to

$$V_{\alpha} = \frac{\frac{W_{\alpha}}{\rho'_{\alpha}}}{\frac{W_{\alpha}}{\rho'_{\alpha}} + \frac{W_{\varepsilon}}{\rho'_{\varepsilon}}}$$

$$= \frac{\frac{0.703}{8.94 \text{ g/cm}^3}}{\frac{0.703}{8.94 \text{ g/cm}^3} + \frac{0.297}{8.25 \text{ g/cm}^3}}$$

$$= 0.686$$

$$V_{\varepsilon} = \frac{\frac{W_{\varepsilon}}{\rho'_{\varepsilon}}}{\frac{W_{\alpha}}{\rho'_{\alpha}} + \frac{W_{\varepsilon}}{\rho'_{\varepsilon}}}$$

$$= \frac{\frac{0.297}{8.25 \text{ g/cm}^3}}{\frac{0.703}{8.94 \text{ g/cm}^3} + \frac{0.297}{8.25 \text{ g/cm}^3}}$$

$$= 0.314$$

Now, using Equation (18.12)

$$\rho = \rho_{\alpha} V_{\alpha} + \rho_{\varepsilon} V_{\varepsilon}$$

$$= (1.88 \times 10^{-8} \Omega \cdot \text{m})(0.686) + (5.32 \times 10^{-7} \Omega \cdot \text{m})(0.314)$$

$$= 1.80 \times 10^{-7} \Omega \cdot \text{m}$$

Finally, for the conductivity [Equation (18.4)]

$$\sigma = \frac{1}{\rho} = \frac{1}{1.80 \times 10^{-7} \Omega \cdot \text{m}} = 5.56 \times 10^6 (\Omega \cdot \text{m})^{-1}$$

18.19 The (a) and (b) portions of the problem ask that we make schematic plots on the same graph for the electrical resistivity versus composition for lead-tin alloys at both room temperature and 150°C; such a graph is shown below.

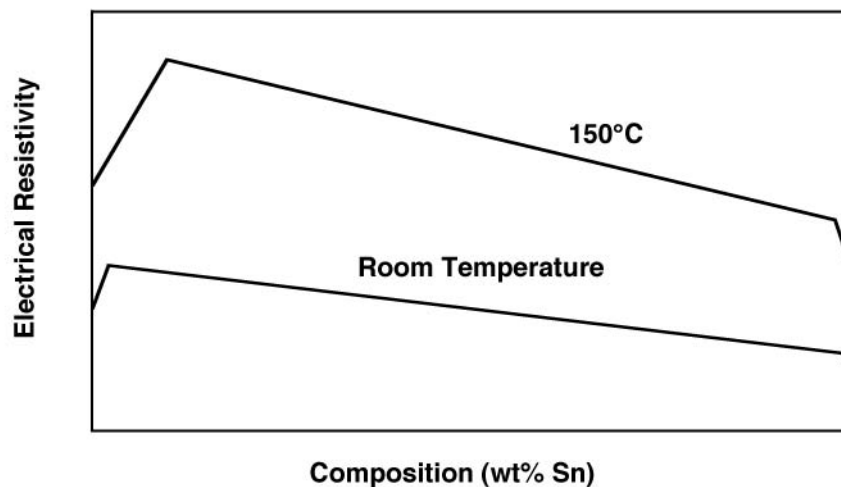

(c) Upon consultation of the Pb-Sn phase diagram (Figure 9.7) we note, upon extrapolation of the two solvus lines to room temperature (e.g., 20°C), that the single phase  $\alpha$  phase solid solution exists between pure lead and a composition of about 2 wt% Sn-98 wt% Pb. In addition, the composition range over which the  $\beta$  phase is between approximately 99 wt% Sn-1 wt% Pb and pure tin. Within both of these composition regions the resistivity increases in accordance with Equation (18.11); also, in the above plot, the resistivity of pure Pb is represented (schematically) as being greater than that for pure Sn, per the problem statement.

Furthermore, for compositions between these extremes, both  $\alpha$  and  $\beta$  phases coexist, and alloy resistivity will be a function of the resistivities the individual phases and their volume fractions, as described by Equation (18.12). Also, mass fractions of the  $\alpha$  and  $\beta$  phases within the two-phase region of Figure 9.7 change linearly with changing composition (according to the lever rule). There is a reasonable disparity between the densities of Pb and Sn (11.35 g/cm<sup>3</sup> versus 7.3 g/cm<sup>3</sup>). Thus, according to Equation (9.6) phase volume fractions will not exactly equal mass fractions, which means that the resistivity will not exactly vary linearly with composition. In the above plot, the curve in this region has been depicted as being linear for the sake of convenience.

At 150°C, the curve has the same general shape, and is shifted to significantly higher resistivities inasmuch as resistivity increases with rising temperature [Equation (18.10) and Figure 18.8]. In addition, from Figure 9.7, at 150°C the solubility of Sn in Pb increases to approximately 10 wt% Sn--i.e., the  $\alpha$  phase field is wider and the increase of resistivity due to the solid solution effect extends over a greater composition range, which is also noted in the figure. The resistivity-temperature behavior is similar on the tin-rich side, where, at 150°C, the  $\beta$  phase field extends to approximately 2 wt% Pb (98 wt% Sn). And, as with the room temperature case, for compositions within the  $\alpha + \beta$  two-phase region, the plot is approximately linear, extending between resistivity values found at the maximum solubilities of the two phases.

18.20 We are asked to select which of several metals may be used for a 2 mm diameter wire to carry 10 A, and have a voltage drop of less than 0.03 V per foot (300 mm). Using Equations (18.3) and (18.4), let us determine the minimum conductivity required, and then select from Table 18.1, those metals that have conductivities greater than this value. The minimum conductivity is just

$$\sigma = \frac{I l}{V A} = \frac{I l}{V \pi \left(\frac{d}{2}\right)^2}$$

$$= \frac{(10 \text{ A})(300 \times 10^{-3} \text{ m})}{(0.03 \text{ V}) (\pi) \left( \frac{2 \times 10^{-3} \text{ m}}{2} \right)^2} = 3.2 \times 10^7 (\Omega \cdot \text{m})^{-1}$$

Thus, from Table 18.1, only aluminum, gold, copper, and silver are candidates.

- 18.21 (a) For this part of the problem, we first read, from Figure 18.15, the number of free electrons (i.e., the intrinsic carrier concentration) at room temperature (298 K). These values are  $n_i(\text{Ge}) = 5 \times 10^{19} \text{ m}^{-3}$  and  $n_i(\text{Si}) = 3 \times 10^{16} \text{ m}^{-3}$ .

Now, the number of atoms per cubic meter for Ge and Si ( $N_{\text{Ge}}$  and  $N_{\text{Si}}$ , respectively) may be determined using Equation (4.2) which involves the densities ( $\rho_{\text{Ge}}$  and  $\rho_{\text{Si}}$ ) and atomic weights ( $A_{\text{Ge}}$  and  $A_{\text{Si}}$ ). (Note: here we use  $\rho$  to represent density in order to avoid confusion with resistivity, which is designated by  $\rho$ .) Therefore,

$$\begin{aligned} N_{\text{Ge}} &= \frac{N_A \rho_{\text{Ge}}}{A_{\text{Ge}}} \\ &= \frac{(6.023 \times 10^{23} \text{ atoms/mol})(5.32 \text{ g/cm}^3)(10^6 \text{ cm}^3/\text{m}^3)}{72.59 \text{ g/mol}} \\ &= 4.4 \times 10^{28} \text{ atoms/m}^3 \end{aligned}$$

Similarly

$$\begin{aligned} N_{\text{Si}} &= \frac{N_A \rho_{\text{Si}}}{A_{\text{Si}}} \\ &= \frac{(6.023 \times 10^{23} \text{ atoms/mol})(2.33 \text{ g/cm}^3)(10^6 \text{ cm}^3/\text{m}^3)}{28.09 \text{ g/mol}} \\ &= 5.00 \times 10^{28} \text{ atoms/m}^3 \end{aligned}$$

Finally, the ratio of the number of free electrons per atom is calculated by dividing  $n$  by  $N$ . For Ge

$$\frac{n_{\text{Ge}}}{N_{\text{Ge}}} = \frac{5 \times 10^{19} \text{ electrons/m}^3}{4.4 \times 10^{28} \text{ atoms/m}^3}$$

$$= 1.1 \times 10^{-9} \text{ electron/atom}$$

And, for Si

$$\frac{n_{\text{Si}}}{N_{\text{Si}}} = \frac{3 \times 10^{16} \text{ electrons/m}^3}{5.00 \times 10^{28} \text{ atoms/m}^3}$$

$$= 6 \times 10^{-13} \text{ electron/atom}$$

(b) The difference is due to the magnitudes of the band gap energies (Table 18.2). The band gap energy at room temperature for Si (1.11 eV) is larger than for Ge (0.67 eV), and, consequently, the probability of excitation across the band gap for a valence electron is much smaller for Si.

18.22 This problem asks that we make plots of  $\ln n_i$  versus reciprocal temperature for both Si and Ge, using the data presented in Figure 18.15, and then determine the band gap energy for each material realizing that the slope of the resulting line is equal to  $-E_g/2k$ .

Below is shown such a plot for Si.

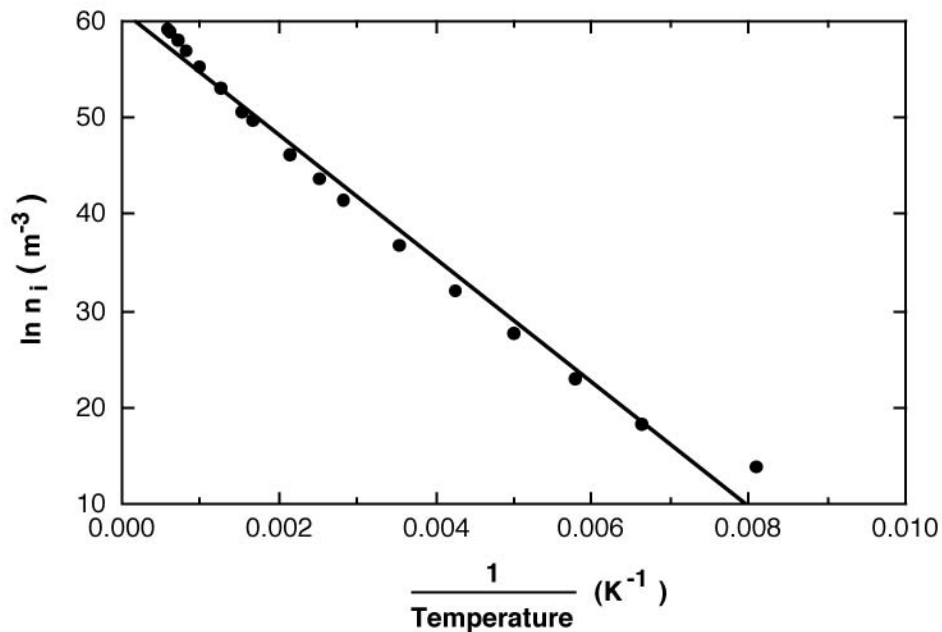

The slope of the line drawn is equal to  $-6400$  which equals an  $E_g$  value of



$$E_g = -2k(\text{slope})$$

$$= -2(8.62 \times 10^{-5} \text{ eV/K})(-6400) = 1.10 \text{ eV}$$

The value cited in Table 18.2 is 1.11 eV.

Now for Ge, an analogous plot is shown below.

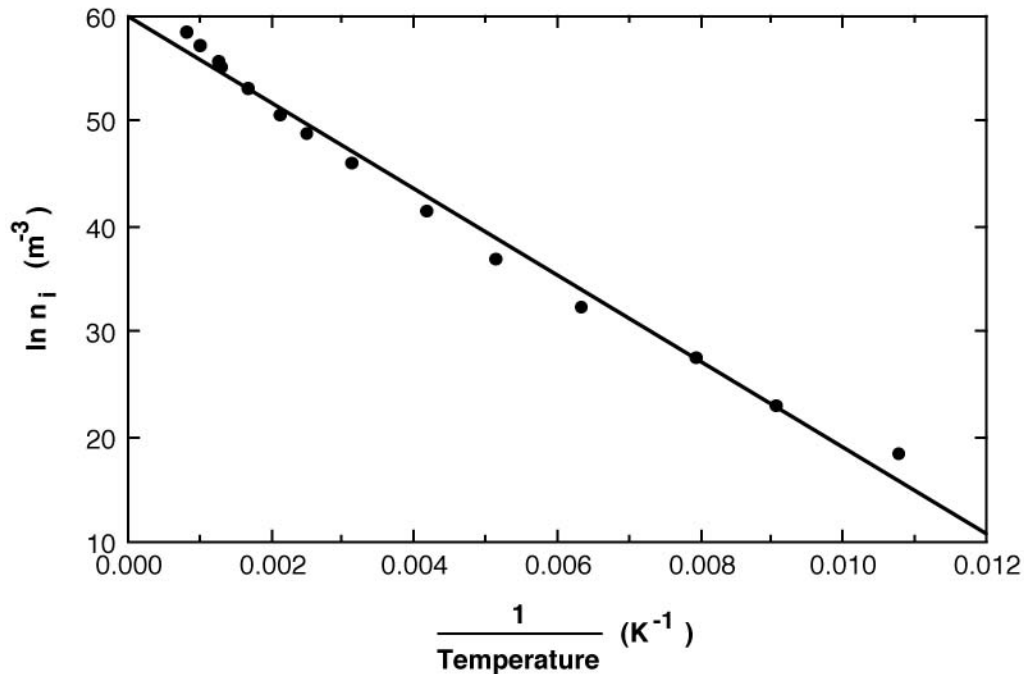

The slope of this line segment is  $-4085$ , which leads to be band gap energy value of

$$E_g = -2k(\text{slope}) = -2(8.62 \times 10^{-5} \text{ eV/K})(-4085) = 0.70 \text{ eV}$$

This value is in good agreement with the 0.67 eV cited in Table 18.2.

18.23 The factor 2 in Equation (18.21a) takes into account the creation of two charge carriers (an electron and a hole) for each valence-band-to-conduction-band intrinsic excitation; both charge carriers may participate in the conduction process.

18.24 These semiconductor terms are defined in the Glossary. Examples are as follows: intrinsic--high purity (undoped) Si, GaAs, CdS, etc.; extrinsic--P-doped Ge, B-doped Si, S-doped GaP, etc.; compound--GaAs, InP, CdS, etc.; elemental--Ge and Si.

18.25 Yes, compound semiconductors can exhibit intrinsic behavior. They will be intrinsic even though they are composed of two different elements as long as the electrical behavior is not influenced by the presence of other elements.

18.26 This problem calls for us to decide for each of several pairs of semiconductors, which will have the smaller band gap energy and then cite reasons for the choice.

(a) Germanium will have a smaller band gap energy than diamond since Ge is lower in row IVA of the periodic table (Figure 2.6) than is C. In moving from top to bottom of the periodic table,  $E_g$  decreases.

(b) Indium antimonide will have a smaller band gap energy than aluminum phosphide. Both of these are III-V compounds, and the positions of both In and Sb are lower vertically in the periodic table than Al and P.

(c) Gallium arsenide will have a smaller band gap energy than zinc selenide. All four of these elements are in the same row of the periodic table, but Zn and Se are more widely separated horizontally than Ga and As; as the distance of separation increases, so does the band gap.

(d) Cadmium telluride will have a smaller band gap energy than zinc selenide. Both are II-VI compounds, and Cd and Te are both lower vertically in the periodic table than Zn and Se.

(e) Cadmium sulfide will have a smaller band gap energy than sodium chloride since Na and Cl are much more widely separated horizontally in the periodic table than are Cd and S.

18.27 The explanations called for in this problem are found in Section 18.11.

18.28 (a) No hole is generated by an electron excitation involving a donor impurity atom because the excitation comes from a level within the band gap, and thus, no missing electron is created from the normally filled valence band.

(b) No free electron is generated by an electron excitation involving an acceptor impurity atom because the electron is excited from the valence band into the impurity level within the band gap; no free electron is introduced into the conduction band.

18.29 Nitrogen will act as a donor in Si. Since it (N) is from group VA of the periodic table (Figure 2.6), an N atom has one more valence electron than an Si atom.

Boron will act as an acceptor in Ge. Since it (B) is from group IIIA of the periodic table, a B atom has one less valence electron than a Ge atom.

Zinc will act as an acceptor in GaAs. Since Zn is from group IIB of the periodic table, it will substitute for Ga; furthermore, a Zn atom has one less valence electron than a Ga atom.

Sulfur will act as a donor in InSb. Since S is from group VIA of the periodic table, it will substitute for Sb; also, an S atom has one more valence electron than an Sb atom.

Indium will act as a donor in CdS. Since In is from group IIIA of the periodic table, it will substitute for Cd; and, an In atom has one more valence electron than a Cd atom.

Arsenic will act as an acceptor in ZnTe. Since As is from group VA of the periodic table, it will substitute for Te; furthermore, an As atom has one less valence electron than a Te atom.

- 18.30 (a) For an intrinsic semiconductor the Fermi energy is located in the vicinity of the center of the band gap.
- (b) For an **n**-type semiconductor the Fermi energy is located in the vicinity of the donor impurity level.
- (c) Below is shown a schematic plot of Fermi energy versus temperature for an **n**-type semiconductor.

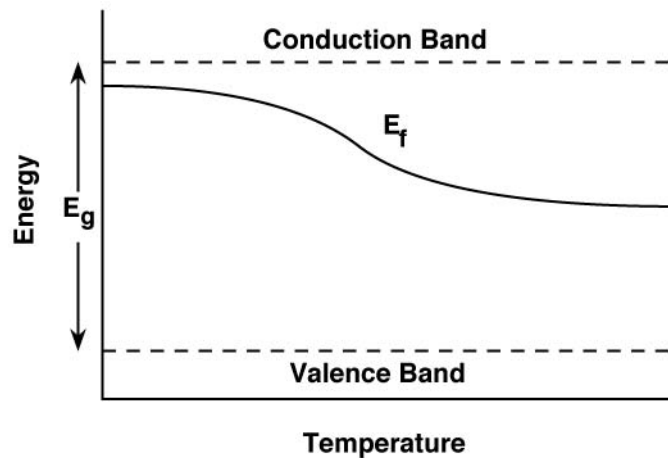

At low temperatures, the material is extrinsic and the Fermi energy is located near the top of the band gap, in the vicinity of the donor level. With increasing temperature, the material eventually becomes intrinsic, and the Fermi energy resides near the center of the band gap.

- 18.31 (a) In this problem, for a Si specimen, we are given  $\mathbf{p}$  and  $\sigma$ , while  $\mu_{\mathbf{h}}$  and  $\mu_{\mathbf{e}}$  are included in Table 18.2. In order to solve for  $\mathbf{n}$  we must use Equation (18.13), which, after rearrangement, leads to

$$n = \frac{\sigma - p|e|\mu_{\mathbf{h}}}{|e|\mu_{\mathbf{e}}}$$

$$\begin{aligned}
&= \frac{10^3 (\Omega - m)^{-1} - (1.0 \times 10^{23} \text{ m}^{-3})(1.602 \times 10^{-19} \text{ C})(0.05 \text{ m}^2/\text{V} - \text{s})}{(1.602 \times 10^{-19} \text{ C})(0.14 \text{ m}^2/\text{V} - \text{s})} \\
&= 8.9 \times 10^{21} \text{ m}^{-3}
\end{aligned}$$

(b) This material is **p**-type extrinsic since **p** ( $1.0 \times 10^{23} \text{ m}^{-3}$ ) is greater than **n** ( $8.9 \times 10^{21} \text{ m}^{-3}$ ).

18.32 In this problem we are asked to compute the intrinsic carrier concentration for PbS at room temperature. Since the conductivity and both electron and hole mobilities are provided in the problem statement, all we need do is solve for **n** and **p** (i.e.,  $n_i$ ) using Equation (18.15). Thus,

$$\begin{aligned}
n_i &= \frac{\sigma}{|e|(\mu_e + \mu_h)} \\
&= \frac{25 (\Omega - m)^{-1}}{(1.602 \times 10^{-19} \text{ C})(0.06 + 0.02) \text{ m}^2/\text{V} - \text{s}} \\
&= 1.95 \times 10^{21} \text{ m}^{-3}
\end{aligned}$$

18.33 (a) This germanium material to which has been added  $10^{24} \text{ m}^{-3}$  As atoms is **n**-type since As is a donor in Ge. (Arsenic is from group VA of the periodic table--Ge is from group IVA.)

(b) Since this material is **n**-type extrinsic, Equation (18.16) is valid. Furthermore, each As atom will donate a single electron, or the electron concentration is equal to the As concentration since all of the As atoms are ionized at room temperature; that is  $n = 10^{24} \text{ m}^{-3}$ , and, as given in the problem statement,  $\mu_e = 0.1 \text{ m}^2/\text{V} - \text{s}$ . Thus

$$\begin{aligned}
\sigma &= n|e|\mu_e \\
&= (10^{24} \text{ m}^{-3})(1.602 \times 10^{-19} \text{ C})(0.1 \text{ m}^2/\text{V} - \text{s}) \\
&= 1.6 \times 10^4 (\Omega - m)^{-1}
\end{aligned}$$

18.34 In order to solve for the electron and hole mobilities for InP, we must write conductivity expressions for the two materials, of the form of Equation (18.13)--i.e.,

$$\sigma = n|e|\mu_e + p|e|\mu_h$$

For the intrinsic material

$$2.5 \times 10^{-6} (\Omega \cdot \text{m})^{-1} = (3.0 \times 10^{13} \text{ m}^{-3})(1.602 \times 10^{-19} \text{ C})\mu_e \\ + (3 \times 10^{13} \text{ m}^{-3})(1.602 \times 10^{-19} \text{ C})\mu_h$$

which reduces to

$$0.52 = \mu_e + \mu_h$$

Whereas, for the extrinsic InP

$$3.6 \times 10^{-5} (\Omega \cdot \text{m})^{-1} = (4.5 \times 10^{14} \text{ m}^{-3})(1.602 \times 10^{-19} \text{ C})\mu_e \\ + (2.0 \times 10^{12} \text{ m}^{-3})(1.602 \times 10^{-19} \text{ C})\mu_h$$

which may be simplified to

$$112.4 = 225\mu_e + \mu_h$$

Thus, we have two independent expressions with two unknown mobilities. Solving for  $\mu_e$  and  $\mu_h$ , we get  $\mu_e = 0.50 \text{ m}^2/\text{V}\cdot\text{s}$  and  $\mu_h = 0.02 \text{ m}^2/\text{V}\cdot\text{s}$ .

18.35 In order to estimate the electrical conductivity of intrinsic silicon at 80°C, we must employ Equation (18.15). However, before this is possible, it is necessary to determine values for  $n_i$ ,  $\mu_e$ , and  $\mu_h$ . According to Figure 18.15, at 80°C (353 K),  $n_i = 1.5 \times 10^{18} \text{ m}^{-3}$ , whereas from the " $<10^{20} \text{ m}^{-3}$ " curves of Figures 18.18a and 18.18b,  $\mu_e = 0.11 \text{ m}^2/\text{V}\cdot\text{s}$  and  $\mu_h = 0.035 \text{ m}^2/\text{V}\cdot\text{s}$  (realizing that the mobility axes of these two plot are scaled logarithmically). Thus, the conductivity at 80°C is

$$\sigma = n_i|e|(\mu_e + \mu_h) \\ \sigma = (1.5 \times 10^{18} \text{ m}^{-3})(1.602 \times 10^{-19} \text{ C})(0.11 \text{ m}^2/\text{V}\cdot\text{s} + 0.035 \text{ m}^2/\text{V}\cdot\text{s}) \\ = 0.035 (\Omega \cdot \text{m})^{-1}$$

18.36 (a) This portion of the problem asks for us to assume that electron and hole mobilities for intrinsic Ge are temperature-dependent, and proportional to  $T^{-3/2}$  for temperature in K. It first becomes necessary to solve for  $C$  in Equation (18.22) using the room-temperature (298 K) conductivity [ $2.2 (\Omega\text{-m})^{-1}$ ] (Table 18.2). This is accomplished as follows:

$$\begin{aligned}\ln C &= \ln \sigma + \frac{3}{2} \ln T + \frac{E_g}{2kT} \\ &= \ln (2.2) + \frac{3}{2} \ln (298) + \frac{0.67 \text{ eV}}{(2)(8.62 \times 10^{-5} \text{ eV/K})(298 \text{ K})} \\ &= 22.38\end{aligned}$$

Now, again using Equation (18.22) we are able to compute the conductivity at 423 K

$$\begin{aligned}\ln \sigma &= \ln C - \frac{3}{2} \ln T - \frac{E_g}{2kT} \\ &= 22.38 - \frac{3}{2} \ln (423 \text{ K}) - \frac{0.67 \text{ eV}}{(2)(8.62 \times 10^{-5} \text{ eV/K})(423 \text{ K})} \\ &= 4.12\end{aligned}$$

which leads to  $e^{4.12} = 61.4 (\Omega\text{-m})^{-1}$ .

18.37 This problem asks that we determine the temperature at which the electrical conductivity of intrinsic Ge is  $40 (\Omega\text{-m})^{-1}$ , using Equation 18.22 and the results of Problem 18.36. First of all, taking logarithms of Equation 18.22

$$\ln \sigma = \ln C - \frac{3}{2} \ln T - \frac{E_g}{2kT}$$

And, from Problem 18.36 the value of  $\ln C$  was determined to be 22.38. Using this and  $\sigma = 40 (\Omega\text{-m})^{-1}$ , the above equation takes the form

$$\ln 40 = 22.38 - \frac{3}{2} \ln T - \frac{0.67 \text{ eV}}{(2)(8.62 \times 10^{-5} \text{ eV/K})(T)}$$

In order to solve for **T** from the above expression it is necessary to use an equation solver. Using **E-Z Solve** and the following instructions

$$\ln(40) = 22.38 - 1.5 \ln(T) - 0.67 / (2 * 8.62 * 10^{-5} * T)$$

When the Calculator icon in the tool bar is selected ("Solve new run" text appears), and then the "Solve" space is selected in the window that appears, the value of **T** = 400 appears in the data grid. This value is the temperature in K which corresponds to 127°C.

18.38 This problem asks that we estimate the temperature at which GaAs has an electrical conductivity of  $3.7 \times 10^{-3} (\Omega\text{-m})^{-1}$  assuming that the conductivity has a temperature dependence as shown in Equation (18.22). From the room temperature (298 K) conductivity [ $10^{-6} (\Omega\text{-m})^{-1}$ ] and band gap energy (1.42 eV) of Table 18.2 we determine the value of **C** [Equation (18.22)] as

$$\begin{aligned} \ln C &= \ln \sigma + \frac{3}{2} \ln T + \frac{E_g}{2kT} \\ &= \ln [10^{-6} (\Omega\text{-m})^{-1}] + \frac{3}{2} \ln (298 \text{ K}) + \frac{1.42 \text{ eV}}{(2)(8.62 \times 10^{-5} \text{ eV/K})(298 \text{ K})} \\ &= 22.37 \end{aligned}$$

Now we substitute this value into Equation (18.22) in order to determine the value of **T** for which  $\sigma = 3.7 \times 10^{-3} (\Omega\text{-m})^{-1}$ :

$$\begin{aligned} \ln \sigma &= \ln C - \frac{3}{2} \ln T - \frac{E_g}{2kT} \\ \ln [3.7 \times 10^{-3} (\Omega\text{-m})^{-1}] &= 22.37 - \frac{3}{2} \ln T - \frac{1.42 \text{ eV}}{(2)(8.62 \times 10^{-5} \text{ eV/K})(T)} \end{aligned}$$

This equation may be solved for **T** using the **E-Z Solve** equation solver. The following text is entered into the workspace

$$\ln(3.7 * 10^{-3}) = 22.37 - 1.5 * \ln(T) - 1.42 / (2 * 8.62 * 10^{-5} * T)$$

And when the Calculator icon in the tool bar is selected ("Solve new run" text appears) button in the toolbar is clicked, and then the "Solve" space is selected in the window that appears, the value of  $T = 437$  appears in the data grid. This value is the temperature in K which corresponds to  $164^{\circ}\text{C}$ .

18.39 This question asks that we compare and then explain the difference in temperature dependence of the electrical conductivity for metals and intrinsic semiconductors. For a pure metal, this temperature dependence is just

$$\sigma = \frac{1}{\rho_0 + aT}$$

[This expression comes from Equations (18.4) and (18.10).] That is, the electrical conductivity decreases with increasing temperature.

By way of contrast, for an intrinsic semiconductor the temperature dependence is represented by an equation of the form of Equation (18.22). This expression contains two terms that involve temperature—a preexponential one (in this case  $T^{-3/2}$ ) and the other in the exponential. With rising temperature the preexponential term decreases, while the  $\exp(-E_g/2kT)$  parameter increases. With regard to relative magnitudes, the exponential term increases much more rapidly than the preexponential one, such that the electrical conductivity of an intrinsic semiconductor increases with rising temperature. Thus, this temperature-dependence of conductivity is just the opposite of that for metals, as outline in the previous paragraph.

The temperature behavior for metals is best explained by consulting Equation (18.8)

$$\sigma = n|e|\mu_e$$

As the temperature rises,  $n$  will remain virtually constant, whereas the mobility ( $\mu_e$ ) will decrease, because the thermal scattering of free electrons will become more efficient. Since  $|e|$  is independent of temperature, the net result will be diminishment in the magnitude of  $\sigma$ .

For an intrinsic semiconductor, Equation (18.15) describes the conductivity; i.e.,

$$\sigma = n|e|(\mu_e + \mu_h) = p|e|(\mu_e + \mu_h)$$

Both  $n$  and  $p$  increase dramatically with rising temperature (Figure 18.15), since more thermal energy becomes available for valence band-conduction band electron excitations. The magnitudes of  $\mu_e$  and  $\mu_h$  will diminish somewhat with increasing temperature (per the upper curves of Figures



18.18a and 18.18b), as a consequence of the thermal scattering of electrons and holes. However, this reduction of  $\mu_e$  and  $\mu_h$  will be overwhelmed by the increase in  $n$  and  $p$ , with the net result is that  $\sigma$  increases with temperature.

18.40 According to Figure 18.16, as dopant level is increased, the position of the horizontal "Extrinsic Region" line moves upward. Thus, the point at which the intrinsic region becomes dominant moves horizontally to higher temperatures.

18.41 This problem asks that we determine the room-temperature electrical conductivity of silicon that has been doped with  $10^{23} \text{ m}^{-3}$  of arsenic atoms. Inasmuch as As is a group VA element in the periodic table (Figure 2.6) it acts as a donor in silicon. Thus, this material is **n**-type extrinsic, and it is necessary to use Equation (18.16), with  $n = 10^{23} \text{ m}^{-3}$  since at room temperature all of the As donor impurities are ionized. The electron mobility, from Figure 18.17 at an impurity concentration of  $10^{23} \text{ m}^{-3}$ , is  $0.065 \text{ m}^2/\text{V}\cdot\text{s}$ . Therefore, the conductivity is equal to

$$\sigma = n|e|\mu_e = (10^{23} \text{ m}^{-3})(1.6 \times 10^{-16} \text{ C})(0.065 \text{ m}^2/\text{V}\cdot\text{s}) = 1040 (\Omega\cdot\text{m})^{-1}$$

18.42 Here we are asked to calculate the room-temperature electrical conductivity of silicon that has been doped with  $2 \times 10^{24} \text{ m}^{-3}$  of boron atoms. Inasmuch as B is a group IIIA element in the periodic table (Figure 2.6) it acts as an acceptor in silicon. Thus, this material is **p**-type extrinsic, and it is necessary to use Equation (18.17), with  $p = 2 \times 10^{24} \text{ m}^{-3}$  since at room temperature all of the B acceptor impurities are ionized. The hole mobility, from Figure 18.17 at an impurity concentration of  $2 \times 10^{24} \text{ m}^{-3}$ , is  $0.0065 \text{ m}^2/\text{V}\cdot\text{s}$ . Therefore, the conductivity is equal to

$$\sigma = n|e|\mu_e = (2 \times 10^{24} \text{ m}^{-3})(1.6 \times 10^{-16} \text{ C})(0.0065 \text{ m}^2/\text{V}\cdot\text{s}) = 2080 (\Omega\cdot\text{m})^{-1}$$

18.43 In this problem we are to estimate the electrical conductivity, at  $75^\circ\text{C}$ , of silicon that has been doped with  $10^{22} \text{ m}^{-3}$  of phosphorous atoms. Inasmuch as P is a group VA element in the periodic table (Figure 2.6) it acts as a donor in silicon. Thus, this material is **n**-type extrinsic, and it is necessary to use Equation (18.16);  $n$  in this expression is  $10^{22} \text{ m}^{-3}$  since at  $75^\circ\text{C}$  all of the P donor impurities are ionized. The electron mobility is determined using Figure 18.18a. From the  $10^{22} \text{ m}^{-3}$  impurity concentration curve and at  $75^\circ\text{C}$  (348 K),  $\mu_e = 0.08 \text{ m}^2/\text{V}\cdot\text{s}$ . Therefore, the conductivity is equal to

$$\sigma = n|e|\mu_e = (10^{22} \text{ m}^{-3})(1.6 \times 10^{-16} \text{ C})(0.08 \text{ m}^2/\text{V}\cdot\text{s}) = 128 (\Omega\cdot\text{m})^{-1}$$

18.44 In this problem we are to estimate the electrical conductivity, at 135°C, of silicon that has been doped with  $10^{24} \text{ m}^{-3}$  of aluminum atoms. Inasmuch as Al is a group IIIA element in the periodic table (Figure 2.6) it acts as an acceptor in silicon. Thus, this material is **p**-type extrinsic, and it is necessary to use Equation (18.17); **p** in this expression is  $10^{24} \text{ m}^{-3}$  since at 135°C all of the Al acceptor impurities are ionized. The hole mobility is determined using Figure 18.18b. From the  $10^{24} \text{ m}^{-3}$  impurity concentration curve and at 135°C (408 K,)  $\mu_h = 0.007 \text{ m}^2/\text{V}\cdot\text{s}$ . Therefore, the conductivity is equal to

$$\sigma = n|e|\mu_h = (10^{24} \text{ m}^{-3})(1.6 \times 10^{-16} \text{ C})(0.007 \text{ m}^2/\text{V}\cdot\text{s}) = 1120 (\Omega\cdot\text{m})^{-1}$$

18.45 We are asked in this problem to determine the electrical conductivity for the nonstoichiometric  $\text{Fe}_{(1-x)}\text{O}$ , given that  $x = 0.060$  and that the hole mobility is  $1.0 \times 10^{-5} \text{ m}^2/\text{V}\cdot\text{s}$ . It is first necessary to compute the number of vacancies per cubic meter for this material. For this determination let us use as our basis 10 unit cells. For the sodium chloride crystal structure (Figure 12.2) there are four cations and four anions per unit cell. Thus, in ten unit cells of FeO there will normally be forty  $\text{O}^{2-}$  and forty  $\text{Fe}^{2+}$  ions. However, when  $x = 0.06$ ,  $(0.06)(40) = 2.4$  of the  $\text{Fe}^{2+}$  sites will be vacant. (Furthermore, there will be 4.8  $\text{Fe}^{3+}$  ions in these ten unit cells inasmuch as two  $\text{Fe}^{3+}$  ions are created for every vacancy). Therefore, each unit cell will, on the average contain 0.24 vacancies. Now, the number of vacancies per cubic meter is just the number of vacancies per unit cell divided by the unit cell volume; this volume is just the unit cell edge length (0.437 nm) cubed. Thus

$$\begin{aligned} \frac{\# \text{ vacancies}}{\text{m}^3} &= \frac{0.24 \text{ vacancies/unit cell}}{(0.437 \times 10^{-9} \text{ m})^3} \\ &= 2.88 \times 10^{27} \text{ vacancies/m}^3 \end{aligned}$$

Inasmuch as it is assumed that the vacancies are saturated, the number of holes (**p**) is also  $2.88 \times 10^{27} \text{ m}^{-3}$ . It is now possible, using Equation (18.17), to compute the electrical conductivity of this material:

$$\begin{aligned} \sigma &= p|e|\mu_h \\ &= (2.88 \times 10^{27} \text{ m}^{-3})(1.602 \times 10^{-19} \text{ C})(1.0 \times 10^{-5} \text{ m}^2/\text{V}\cdot\text{s}) = 4600 (\Omega\cdot\text{m})^{-1} \end{aligned}$$

18.46W (a) This portion of the problem calls for us to determine the electron mobility for some hypothetical metal having an electrical resistivity of  $3.3 \times 10^{-8} \text{ } (\Omega\text{-m})$ , given that the specimen thickness is 15 mm, and that when  $\mathbf{I}_x = 25 \text{ A}$  and  $\mathbf{B}_z = 0.95 \text{ tesla}$  a  $\mathbf{V}_H$  of  $-2.4 \times 10^{-7} \text{ V}$  is produced.

It is first necessary to convert resistivity to conductivity (Equation 18.4). Thus

$$\sigma = \frac{1}{\rho} = \frac{1}{3.3 \times 10^{-8} \text{ } (\Omega\text{-m})} = 3.0 \times 10^7 \text{ } (\Omega\text{-m})^{-1}$$

The electron mobility may be determined using Equation (18.3bW); and upon incorporation of Equation (18.1W), we have

$$\begin{aligned} \mu_e &= |R_H| \sigma \\ &= \frac{|V_H| d \sigma}{I_x B_z} \\ &= \frac{(|-2.4 \times 10^{-7} \text{ V}|)(15 \times 10^{-3} \text{ m})[3.0 \times 10^7 \text{ } (\Omega\text{-m})^{-1}]}{(25 \text{ A})(0.95 \text{ tesla})} \\ &= 0.0045 \text{ m}^2/\text{V}\text{-s} \end{aligned}$$

(b) Now we are to calculate the number of free electrons per cubic meter. From Equation (18.8) we have

$$\begin{aligned} n &= \frac{\sigma}{|e| \mu_e} \\ &= \frac{3.0 \times 10^7 \text{ } (\Omega\text{-m})^{-1}}{(1.602 \times 10^{-19} \text{ C})(0.0045 \text{ m}^2/\text{V}\text{-s})} \\ &= 4.17 \times 10^{28} \text{ m}^{-3} \end{aligned}$$

18.47W In this problem we are asked to determine the magnetic field required to produce a Hall voltage of  $-3.5 \times 10^{-7} \text{ V}$ , given that  $\sigma = 1.2 \times 10^7 \text{ } (\Omega\text{-m})^{-1}$ ,  $\mu_e = 0.0050 \text{ m}^2/\text{V}\text{-s}$ ,  $\mathbf{I}_x = 40 \text{ A}$ , and  $\mathbf{d} = 35 \text{ mm}$ . Combining Equations (18.1W) and (18.3bW), and after solving for  $\mathbf{B}_z$ , we get

$$B_z = \frac{|V_H| \sigma d}{I_x \mu_e}$$

$$= \frac{(|-3.5 \times 10^{-7} \text{ V}|) [1.2 \times 10^7 (\Omega \cdot \text{m})^{-1}] (35 \times 10^{-3} \text{ m})}{(40 \text{ A}) (0.0050 \text{ m}^2/\text{V} \cdot \text{s})}$$

$$= 0.74 \text{ tesla}$$

18.48 The explanations called for are found in Section 18.15.

18.49 The energy generated by the electron-hole annihilation reaction, Equation (18.18), is dissipated as heat.

18.50 In an electronic circuit, a transistor may be used to 1) amplify an electrical signal, and 2) act as a switching device in computers.

18.51 If the temperature of a **p-n** junction rectifier or a junction transistor is raised high enough, the semiconducting materials will become intrinsic and the device will become inoperative. Furthermore, diffusion of doping species from a **p** region to an **n** region and vice versa may occur, which would also lead to performance problems.

18.52 The differences in operation and application for junction transistors and MOSFETs are described in Section 18.15.

18.53 For this problem, we are given, for NaCl, the activation energy (173,000 J/mol) and preexponential ( $4.0 \times 10^{-4} \text{ m}^2/\text{s}$ ) for the diffusion coefficient of  $\text{Na}^+$  and are asked to compute the mobility for a  $\text{Na}^+$  ion at 873 K. The mobility,  $\mu_{\text{Na}^+}$ , may be computed using Equation (18.20); however, this expression also includes the diffusion coefficient  $D_{\text{Na}^+}$ , which is determined using Equation (5.8) as

$$D_{\text{Na}^+} = D_o \exp\left(-\frac{Q_d}{RT}\right)$$

$$= (4.0 \times 10^{-4} \text{ m}^2/\text{s}) \exp\left[-\frac{173,000 \text{ J/mol}}{(8.31 \text{ J/mol} \cdot \text{K})(873 \text{ K})}\right]$$

$$= 1.76 \times 10^{-14} \text{ m}^2/\text{s}$$

Now solving for  $\mu_{\text{Na}^+}$  yields

$$\begin{aligned} \mu_{\text{Na}^+} &= \frac{n_{\text{Na}} e D_{\text{Na}^+}}{kT} \\ &= \frac{(1)(1.602 \times 10^{-19} \text{ C/atom})(1.76 \times 10^{-14} \text{ m}^2/\text{s})}{(1.38 \times 10^{-23} \text{ J/atom-K})(873 \text{ K})} \\ &= 2.34 \times 10^{-13} \text{ m}^2/\text{V-s} \end{aligned}$$

18.54W We want to compute the plate spacing of a parallel-plate capacitor as the dielectric constant is increased from 2.5 to 4.0, while maintaining the capacitance constant. Combining Equations (18.6W) and (18.7W) yields

$$C = \frac{\epsilon_r \epsilon_0 A}{l}$$

Now, let us use the subscripts **1** and **2** to denote the initial and final states, respectively. Since  $C_1 = C_2$ , then

$$\frac{\epsilon_{r1} \epsilon_0 A}{l_1} = \frac{\epsilon_{r2} \epsilon_0 A}{l_2}$$

And, solving for  $l_2$

$$l_2 = \frac{\epsilon_{r2} l_1}{\epsilon_{r1}} = \frac{(4.0)(1 \text{ mm})}{2.5} = 1.6 \text{ mm}$$

18.55W This problem asks for us to ascertain which of the materials listed in Table 18.1W are candidates for a parallel-plate capacitor that has dimensions of 38 mm by 65 mm, a plate separation of 1.3 mm so as to have a minimum capacitance of  $7 \times 10^{-11}$  F, when an ac potential of 1000 V is applied at 1 MHz. Upon combining Equations (18.6W) and (18.7W) and solving for the dielectric constant  $\epsilon_r$  we get

$$\begin{aligned}\epsilon_r &= \frac{QC}{\epsilon_0 A} \\ &= \frac{(1.3 \times 10^{-3} \text{ m})(7 \times 10^{-11} \text{ F})}{(8.85 \times 10^{-12} \text{ F/m})(38 \times 10^{-3} \text{ m})(65 \times 10^{-3} \text{ m})} \\ &= 4.16\end{aligned}$$

Thus, the minimum value of  $\epsilon_r$  to achieve the desired capacitance is 4.16 at 1 MHz. Of those materials listed in the table, titanate ceramics, mica, steatite, soda-lime glass, porcelain, and phenol-formaldehyde are candidates.

18.56W In this problem we are given, for a parallel-plate capacitor, its area ( $3225 \text{ mm}^2$ ), the plate separation (1 mm), and that a material having an  $\epsilon_r$  of 3.5 is positioned between the plates.

(a) We are first asked to compute the capacitance. Combining Equations (18.6W) and (18.7W), and solving for **C** yields

$$\begin{aligned}C &= \frac{\epsilon_r \epsilon_0 A}{l} \\ &= \frac{(3.5)(8.85 \times 10^{-12} \text{ F/m})(3225 \text{ mm}^2)(1 \text{ m}^2 / 10^6 \text{ mm}^2)}{10^{-3} \text{ m}} \\ &= 10^{-10} \text{ F} = 100 \text{ pF}\end{aligned}$$

(b) Now we are asked to compute the electric field that must be applied in order that  $2 \times 10^{-8} \text{ C}$  be stored on each plate. First we need to solve for **V** in Equation (18.4W) as

$$V = \frac{Q}{C} = \frac{2 \times 10^{-8} \text{ C}}{10^{-10} \text{ F}} = 200 \text{ V}$$

The electric field **E** may now be determined using Equation (18.6); thus

$$E = \frac{V}{l} = \frac{200 \text{ V}}{10^{-3} \text{ m}} = 2.0 \times 10^5 \text{ V/m}$$

18.57W This explanation is found in Section 18.19W.

18.58W Shown below are the relative positions of  $\text{Na}^+$  and  $\text{Cl}^-$  ions, without and with an electric field present.



Now,

$$d = r_{\text{Na}^+} + r_{\text{Cl}^-} = 0.102 \text{ nm} + 0.181 \text{ nm} = 0.283 \text{ nm}$$

and

$$\Delta d = 0.05 d = (0.05)(0.283 \text{ nm}) = 0.0142 \text{ nm} = 1.42 \times 10^{-11} \text{ m}$$

From Equation (18.8W), the dipole moment,  $\mathbf{p}$ , is just

$$\begin{aligned} p &= q \Delta d \\ &= (1.602 \times 10^{-19} \text{ C})(1.42 \times 10^{-11} \text{ m}) \\ &= 2.26 \times 10^{-30} \text{ C}\cdot\text{m} \end{aligned}$$

18.59W (a) In order to solve for the dielectric constant in this problem, we must employ Equation (18.12W), which includes polarization and electric field parameters; values for these parameters are given in the problem statement. Solving for  $\epsilon_r$  from this expression gives

$$\epsilon_r = \frac{P}{\epsilon_0 E} + 1$$

$$= \frac{1.0 \times 10^{-6} \text{ C/m}^2}{(8.85 \times 10^{-12} \text{ F/m})(5 \times 10^4 \text{ V/m})} + 1$$

$$= 3.26$$

(b) The dielectric displacement may be determined using Equation (18.11W), as

$$D = \epsilon_0 E + P$$

$$= (8.85 \times 10^{-12} \text{ F/m})(5 \times 10^4 \text{ V/m}) + 1.0 \times 10^{-6} \text{ C/m}^2$$

$$= 1.44 \times 10^{-6} \text{ C/m}^2$$

18.60W (a) We want to solve for the voltage when  $Q = 3.5 \times 10^{-11} \text{ C}$ ,  $A = 160 \text{ mm}^2$ ,  $l = 3.5 \text{ mm}$ , and  $\epsilon_r = 5.0$ . Combining Equations (18.4W), (18.6W), and (18.7W) yields

$$\frac{Q}{V} = \epsilon_r \epsilon_0 \frac{A}{l}$$

And, solving for  $V$

$$V = \frac{Ql}{\epsilon_r \epsilon_0 A}$$

$$= \frac{(3.5 \times 10^{-11} \text{ C})(3.5 \times 10^{-3} \text{ m})}{(5.0)(8.85 \times 10^{-12} \text{ F/m})(160 \text{ mm}^2)(1 \text{ m}^2 / 10^6 \text{ mm}^2)}$$

$$= 17.3 \text{ V}$$

(b) For this same capacitor, if a vacuum is used

$$V = \frac{Ql}{\epsilon_0 A}$$

$$= \frac{(3.5 \times 10^{-11} \text{ C})(3.5 \times 10^{-3} \text{ m})}{(8.85 \times 10^{-12} \text{ F/m})(160 \times 10^{-6} \text{ m}^2)}$$



$$= 86.5 \text{ V}$$

(c) The capacitance for part (a) is just

$$C = \frac{Q}{V} = \frac{3.5 \times 10^{-11} \text{ C}}{17.3 \text{ V}} = 2.0 \times 10^{-12} \text{ F}$$

And for part (b)

$$C = \frac{Q}{V} = \frac{3.5 \times 10^{-11} \text{ C}}{86.5 \text{ V}} = 4.0 \times 10^{-13} \text{ F}$$

(d) The dielectric displacement may be computed by combining Equations (18.11W), (18.12W), and (18.6), as

$$\begin{aligned} D &= \epsilon_0 E + \epsilon_0(\epsilon_r - 1)E = \epsilon_0 \epsilon_r E = \frac{\epsilon_0 \epsilon_r V}{l} \\ &= \frac{(8.85 \times 10^{-12} \text{ F/m})(5.0)(17.3 \text{ V})}{3.5 \times 10^{-3} \text{ m}} \\ &= 2.2 \times 10^{-7} \text{ C/m}^2 \end{aligned}$$

(e) The polarization is determined using Equations (18.12W) and (18.6) as

$$\begin{aligned} P &= \epsilon_0(\epsilon_r - 1) \frac{V}{l} \\ &= \frac{(8.85 \times 10^{-12} \text{ F/m})(5.0 - 1)(17.3 \text{ V})}{3.5 \times 10^{-3} \text{ m}} \\ &= 1.75 \times 10^{-7} \text{ C/m}^2 \end{aligned}$$

18.61W (a) For electronic polarization, the electric field causes a net displacement of the center of the negatively charged electron cloud relative to the positive nucleus. With ionic polarization, the cations and anions are displaced in opposite directions as a result of the application of an electric field.

Orientation polarization is found in substances that possess permanent dipole moments; these dipole moments become aligned in the direction of the electric field.

(b) Only electronic polarization is to be found in gaseous argon; being an inert gas, its atoms will not be ionized nor possess permanent dipole moments.

Both electronic and ionic polarizations will be found in solid LiF, since it is strongly ionic. In all probability, no permanent dipole moments will be found in this material.

Both electronic and orientation polarizations are found in liquid H<sub>2</sub>O. The H<sub>2</sub>O molecules have permanent dipole moments that are easily oriented in the liquid state.

Only electronic polarization is to be found in solid Si; this material does not have molecules with permanent dipole moments, nor is it an ionic material.

18.62W For this soda-lime glass, in order to determine the fraction of the dielectric constant at low frequencies that is attributed to ionic polarization, we must determine the  $\epsilon_r$  within this low-frequency regime; such is tabulated in Table 18.1W, and at 1 MHz its value is 6.9. Thus, this fraction is just

$$\begin{aligned} \text{fraction} &= \frac{\epsilon_r(\text{low}) - \epsilon_r(\text{high})}{\epsilon_r(\text{low})} \\ &= \frac{6.9 - 2.3}{6.9} = 0.67 \end{aligned}$$

18.63W (a) This portion of the problem asks that we compute the magnitude of the dipole moment associated with each unit cell of BaTiO<sub>3</sub>, which is illustrated in Figure 18.26. The dipole moment  $\mathbf{p}$  is defined by Equation (18.8W) as  $\mathbf{p} = \mathbf{q}\mathbf{d}$  in which  $\mathbf{q}$  is the magnitude of each dipole charge, and  $\mathbf{d}$  is the distance of separation between the charges. Each Ti<sup>4+</sup> ion has four units of charge associated with it, and thus  $\mathbf{q} = (4)(1.602 \times 10^{-19} \text{ C}) = 6.41 \times 10^{-19} \text{ C}$ . Furthermore,  $\mathbf{d}$  is the distance the Ti<sup>4+</sup> ion has been displaced from the center of the unit cell, which is just 0.006 nm + 0.006 nm = 0.012 nm [Figure 18.26(b)]. Hence

$$\begin{aligned} p &= qd = (6.41 \times 10^{-19} \text{ C})(0.012 \times 10^{-9} \text{ m}) \\ &= 7.69 \times 10^{-30} \text{ C} \cdot \text{m} \end{aligned}$$

(b) Now it becomes necessary to compute the maximum polarization that is possible for this material. The maximum polarization will exist when the dipole moments of all unit cells are aligned in the same direction. Furthermore, it is computed by dividing the value of  $\mathbf{p}$  by the volume of each

unit cell, which is equal to the product of three unit cell edge lengths, as shown in Figure 18.26. Thus

$$\begin{aligned}
 P &= \frac{p}{V_C} \\
 &= \frac{7.69 \times 10^{-30} \text{ C} \cdot \text{m}}{(0.403 \times 10^{-9} \text{ m})(0.398 \times 10^{-9} \text{ m})(0.398 \times 10^{-9} \text{ m})} \\
 &= 0.121 \text{ C/m}^2
 \end{aligned}$$

18.64W The ferroelectric behavior of  $\text{BaTiO}_3$  ceases above its ferroelectric Curie temperature because the unit cell transforms from tetragonal geometry to cubic; thus, the  $\text{Ti}^{4+}$  is situated at the center of the cubic unit cell, there is no charge separation, and no net dipole moment.

18.65 Yes, the physical dimensions of a piezoelectric material such as  $\text{BaTiO}_3$  change when it is subjected to an electric field. As noted in Figure 18.27, a voltage (or electric field) is generated when the dimensions of a piezoelectric material are altered. Thus, it would be logical to expect the reverse effect to occur--that is, placing the material within an electric field causes its physical dimensions to change.

### Design Problems

18.D1 This problem asks that we calculate the composition of a copper-nickel alloy that has a room temperature resistivity of  $2.5 \times 10^{-7} \Omega\text{-m}$ . The first thing to do is, using the 90 Cu-10 Ni resistivity data, determine the impurity contribution, and, from this result, calculate the constant **A** in Equation (18.11). Thus,

$$\rho_{\text{total}} = 1.90 \times 10^{-7} (\Omega\text{-m}) = \rho_i + \rho_t$$

From Table 18.1, for pure copper

$$\rho_t = \frac{1}{\sigma} = \frac{1}{6.0 \times 10^7 (\Omega\text{-m})^{-1}} = 1.67 \times 10^{-8} (\Omega\text{-m})$$

Thus, for the 90 Cu-10 Ni alloy

$$\begin{aligned}\rho_i &= \rho_{\text{total}} - \rho_t = 1.90 \times 10^{-7} - 1.67 \times 10^{-8} \\ &= 1.73 \times 10^{-7} \text{ } (\Omega\text{-m})\end{aligned}$$

In the problem statement, the impurity (i.e., nickel) concentration is expressed in weight percent. However, Equation (18.11) calls for concentration in atom fraction (i.e., atom percent divided by 100). Consequently, conversion from weight percent to atom fraction is necessary. (Note: we now choose to denote the atom fraction of nickel as  $c'_{\text{Ni}}$ , and the weight percents of Ni and Cu by  $C_{\text{Ni}}$  and  $C_{\text{Cu}}$ , respectively.) Using these notations, this conversion may be accomplished by using a modified form of Equation (4.6a) as

$$c'_{\text{Ni}} = \frac{C_{\text{Ni}}A_{\text{Cu}}}{C_{\text{Ni}}A_{\text{Cu}} + C_{\text{Cu}}A_{\text{Ni}}}$$

Here  $A_{\text{Ni}}$  and  $A_{\text{Cu}}$  denote the atomic weights of nickel and copper. Thus

$$\begin{aligned}c'_{\text{Ni}} &= \frac{(10 \text{ wt\%})(63.55 \text{ g/mol})}{(10 \text{ wt\%})(63.55 \text{ g/mol}) + (90 \text{ wt\%})(58.69 \text{ g/mol})} \\ &= 0.107\end{aligned}$$

Now, solving for  $A$  in Equation (18.11)

$$\begin{aligned}A &= \frac{\rho_i}{c'_{\text{Ni}}(1 - c'_{\text{Ni}})} \\ &= \frac{1.73 \times 10^{-7} (\Omega\text{-m})}{(0.107)(1 - 0.107)} = 1.81 \times 10^{-6} \text{ } (\Omega\text{-m})\end{aligned}$$

Finally, it is possible to compute the  $c'_{\text{Ni}}$  to give a room temperature resistivity of  $2.5 \times 10^{-7} \Omega\text{-m}$ . Again, we must determine  $\rho_i$  as

$$\rho_i = \rho_{\text{total}} - \rho_t$$

$$= 2.5 \times 10^{-7} - 1.67 \times 10^{-8} = 2.33 \times 10^{-7} \text{ } (\Omega \cdot \text{m})$$

If Equation (18.11) is expanded, then

$$\rho_i = A c_{\text{Ni}}' - A c_{\text{Ni}}'^2$$

and, solving for  $c_{\text{Ni}}'$

$$c_{\text{Ni}}' = \frac{A \pm \sqrt{A^2 - 4A\rho_i}}{2A}$$

Or

$$c_{\text{Ni}}' = \frac{1.81 \times 10^{-6} \pm \sqrt{(1.81 \times 10^{-6})^2 - (4)(1.81 \times 10^{-6})(2.33 \times 10^{-7})}}{(2)(1.81 \times 10^{-6})}$$

And, taking the negative root,

$$c_{\text{Ni}}' = 0.152$$

which is equivalent to a concentration of 15.2 at% Ni. Now, converting this composition to weight percent Ni, requires that we use Equation (4.7a) as

$$\begin{aligned} C_{\text{Ni}} &= \frac{C_{\text{Ni}}' A_{\text{Ni}}}{C_{\text{Ni}}' A_{\text{Ni}} + C_{\text{Cu}}' A_{\text{Cu}}} \times 100 \\ &= \frac{(15.2 \text{ at%})(58.69 \text{ g/mol})}{(15.2 \text{ at%})(58.69 \text{ g/mol}) + (84.8 \text{ at%})(63.55 \text{ g/mol})} \times 100 \\ &= 14.2 \text{ wt\%} \end{aligned}$$

18.D2 This problem asks that we determine the electrical conductivity of an 85 wt% Cu-15 wt% Zn alloy at  $-100^\circ\text{C}$  using information contained in Figures 18.8 and 18.28. In order to solve this problem it is necessary to employ Equation (18.9) which is of the form

$$\rho_{\text{total}} = \rho_t + \rho_i$$

since it is assumed that the alloy is undeformed. Let us first determine the value of  $\rho_i$  at room temperature (25°C) which value will be independent of temperature. From Figure (18.8), at 25°C and for pure Cu,  $\rho_t(25) = 1.75 \times 10^{-8} \Omega\text{-m}$ . Now, since it is assumed that the curve in Figure 18.28 was generated also at room temperature, we may take  $\rho$  as  $\rho_{\text{total}}(25)$  at 85 wt% Cu-15 wt% Zn which has a value of  $4.7 \times 10^{-8} \Omega\text{-m}$ . Thus

$$\begin{aligned} \rho_i &= \rho_{\text{total}}(25) - \rho_t(25) \\ &= 4.7 \times 10^{-8} \Omega\text{-m} - 1.75 \times 10^{-8} \Omega\text{-m} = 2.95 \times 10^{-8} \Omega\text{-m} \end{aligned}$$

Finally, we may determine the resistivity at -100°C,  $\rho_{\text{total}}(-100)$ , by taking the resistivity of pure Cu at -100°C from Figure 18.8, which gives us  $\rho_t(-100) = 0.90 \times 10^{-8} \Omega\text{-m}$ . Therefore

$$\begin{aligned} \rho_{\text{total}}(-100) &= \rho_i + \rho_t(-100) \\ &= 2.95 \times 10^{-8} \Omega\text{-m} + 0.90 \times 10^{-8} \Omega\text{-m} = 3.85 \times 10^{-8} \Omega\text{-m} \end{aligned}$$

And, using Equation (18.4) the conductivity is calculated as

$$\sigma = \frac{1}{\rho} = \frac{1}{3.85 \times 10^{-8} \Omega\text{-m}} = 2.60 \times 10^7 (\Omega\text{-m})^{-1}$$

18.D3 To solve this problem, we want to consult Figures 7.14(b) and (18.9) in order to determine the Ni concentration ranges over which the yield strength is greater than 130 MPa (19,000 psi) and the conductivity exceeds  $4.0 \times 10^6 (\Omega\text{-m})^{-1}$ .

From Figure 7.14(b), a Ni concentration greater than about 23 wt% is necessary for a yield strength in excess of 130 MPa. In Figure 18.9 is plotted the resistivity versus the Ni content. Since conductivity is the reciprocal of resistivity, the resistivity must be less than  $25 \times 10^{-8} \Omega\text{-m}$ --i.e.,  $\frac{1}{4.0 \times 10^6 (\Omega\text{-m})^{-1}}$ . According to the figure, this will be the case for Ni concentrations less than 17 wt%.

Hence, it is **not** possible to prepare an alloy meeting the criteria; for the stipulated yield strength the required Ni content must be greater than 23 wt%, whereas for the required conductivity, less than 17 wt% is necessary.

18.D4 First of all, those elements which, when added to silicon render it **n**-type, lie one group to the right of silicon in the periodic table; these include the group VA elements (Figure 2.6)—i.e., nitrogen, phosphorus, arsenic, and antimony.

Since this material is extrinsic and **n**-type,  $n \gg p$ , and the electrical conductivity is a function of the hole concentration according to Equation (18.16). Also, the number of free electrons is about equal to the number of donor impurities,  $N_d$ . That is

$$n \sim N_d$$

From Equation (18.16), the conductivity is a function of both the electron concentration (**n**) and the electron mobility ( $\mu_e$ ). Furthermore, the room-temperature electron mobility is dependent on impurity concentration (Figure 18.17). One way to solve this problem is to use an iterative approach—i.e., assume some donor impurity concentration (which will also equal the value of **n**), then determine a "calculated" electron mobility from Equation 18.16—i.e.,

$$\mu_e = \frac{\sigma}{n |e|}$$

and, finally, compare this mobility with the "measured" value from Figure 18.17, taken at the assumed **n** (i.e.,  $N_d$ ) value.

Let us begin by assuming that  $N_d = 10^{22} \text{ m}^{-3}$ . Thus, the "calculated" mobility value is

$$\mu_e = \frac{\sigma}{n |e|} = \frac{200 (\Omega \cdot \text{m})^{-1}}{(10^{22} \text{ m}^{-3})(1.602 \times 10^{-19} \text{ C})} = 0.125 \text{ m}^2/\text{V} \cdot \text{s}$$

From Figure 18.17, at an impurity concentration of  $10^{22} \text{ m}^{-3}$  the "measured" electron mobility is  $0.10 \text{ m}^2/\text{V} \cdot \text{s}$ , which is slightly lower than the "calculated" value.

For our next choice, let us assume a higher impurity concentration, say  $10^{23} \text{ m}^{-3}$ . At this higher concentration there will be a reduction of both "calculated" and "measured" electron mobilities. The "calculated" value is just

$$\mu_e = \frac{\sigma}{n |e|} = \frac{200 (\Omega \cdot \text{m})^{-1}}{(10^{23} \text{ m}^{-3})(1.602 \times 10^{-19} \text{ C})} = 0.0125 \text{ m}^2/\text{V} \cdot \text{s}$$

Whereas, Figure 18.17 yields a "measured"  $\mu_e$  of  $0.05 \text{ m}^2/\text{V}\cdot\text{s}$ , which is higher than the "calculated" value. Therefore, the correct impurity concentration will lie somewhere between  $10^{22}$  and  $10^{23} \text{ m}^{-3}$  probably closer to the lower of these two values. At  $1.3 \times 10^{22} \text{ m}^{-3}$ , "measured" and "calculated"  $\mu_e$  values are about equal ( $0.095 \text{ m}^2/\text{V}\cdot\text{s}$ ).

It next becomes necessary to calculate the concentration of donor impurities in atom percent. This computation first requires the determination of the number of silicon atoms per cubic meter,  $N_{\text{Si}}$ , using Equation (4.2), which is as follows

$$N_{\text{Si}} = \frac{N_A \rho_{\text{Si}}}{A_{\text{Si}}}$$

$$= \frac{(6.023 \times 10^{23} \text{ atoms/mol})(2.33 \text{ g/cm}^3)(10^6 \text{ cm}^3/\text{m}^3)}{28.09 \text{ g/mol}}$$

$$= 5 \times 10^{28} \text{ m}^{-3}$$

(Note: in the above discussion, the density of silicon is represented by  $\rho_{\text{Si}}$  in order to avoid confusion with resistivity, which is designated by  $\rho$ .)

The concentration of donor impurities in atom percent ( $C'_d$ ) is just the ratio of  $N_d$  and  $(N_d + N_{\text{Si}})$  multiplied by 100 as

$$C'_d = \frac{N_d}{N_d + N_{\text{Si}}} \times 100$$

$$= \frac{1.3 \times 10^{22} \text{ m}^{-3}}{(1.3 \times 10^{22} \text{ m}^{-3}) + (5 \times 10^{28} \text{ m}^{-3})} \times 100 = 2.6 \times 10^{-5} \text{ at\%}$$

Now, conversion to weight percent ( $C_d$ ) is possible using Equation (4.7a) as

$$C_d = \frac{C'_d A_d}{C'_d A_d + C'_{\text{Si}} A_{\text{Si}}} \times 100$$

where  $A_d$  and  $A_{\text{Si}}$  are the atomic weights of the donor and silicon, respectively. Thus, the concentration in weight percent will depend on the particular donor type. For example, for nitrogen



$$C_N = \frac{C'_N A_N}{C'_N A_N + C'_{Si} A_{Si}} \times 100$$

$$= \frac{(2.6 \times 10^{-5} \text{ at\%})(14.01 \text{ g/mol})}{(2.6 \times 10^{-5} \text{ at\%})(14.01 \text{ g/mol}) + (99.999974 \text{ at\%})(28.09 \text{ g/mol})} \times 100$$

$$= 1.3 \times 10^{-5} \text{ wt\%}$$

Similar calculations may be carried out for the other possible donor impurities which yield

$$C_P = 2.87 \times 10^{-5} \text{ wt\%}$$

$$C_{As} = 6.93 \times 10^{-5} \text{ wt\%}$$

$$C_{Sb} = 1.127 \times 10^{-4} \text{ wt\%}$$

18.D5 This problem asks for us to determine the temperature at which boron is to be diffused into high-purity silicon in order to achieve a room-temperature electrical conductivity of  $1000 (\Omega\text{-m})^{-1}$  at a distance  $0.2 \mu\text{m}$  from the surface if the B concentration at the surface is maintained at  $1.0 \times 10^{25} \text{ m}^{-3}$ . It is first necessary for us to compute the hole concentration (since B is an acceptor in Si) at this  $0.2 \mu\text{m}$  location.

From Equation (18.17), the conductivity is a function of both the hole concentration ( $\mathbf{p}$ ) and the hole mobility ( $\mu_h$ ). Furthermore, the room-temperature hole mobility is dependent on impurity concentration (Figure 18.17). One way to solve this problem is to use an iterative approach—i.e., assume some boron concentration,  $\mathbf{N}_b$  (which will also equal the value of  $\mathbf{p}$ ), then determine a "calculated" hole mobility from Equation 18.17—i.e.,

$$\mu_h = \frac{\sigma}{p |e|}$$

and then compare this mobility with the "measured" value from Figure 18.17, taken at the assumed  $\mathbf{p}$  (i.e.,  $\mathbf{N}_b$ ).

Let us begin by assuming that  $\mathbf{N}_b = 10^{24} \text{ m}^{-3}$ . Thus, the "calculated" mobility value is

$$\mu_h = \frac{\sigma}{p |e|} = \frac{1000 (\Omega - m)^{-1}}{(10^{24} \text{ m}^{-3})(1.602 \times 10^{-19} \text{ C})} = 0.0062 \text{ m}^2 / \text{V} - \text{s}$$

From Figure 18.17, at an impurity concentration of  $10^{24} \text{ m}^{-3}$  the "measured" hole mobility is  $0.01 \text{ m}^2/\text{V-s}$ , which is higher than the "calculated" value.

For our next choice, let us assume a lower boron concentration, say  $10^{23} \text{ m}^{-3}$ . At this lower concentration there will be an increase of both "calculated" and "measured" hole mobilities. The "calculated" value is just

$$\mu_h = \frac{\sigma}{p |e|} = \frac{1000 (\Omega - m)^{-1}}{(10^{23} \text{ m}^{-3})(1.602 \times 10^{-19} \text{ C})} = 0.062 \text{ m}^2 / \text{V} - \text{s}$$

Whereas, Figure 18.17 yields a "measured"  $\mu_h$  of  $0.034 \text{ m}^2/\text{V-s}$ , which is lower than the "calculated" value. Therefore, the correct impurity concentration will lie somewhere between  $10^{23}$  and  $10^{24} \text{ m}^{-3}$ . At  $4.0 \times 10^{23} \text{ m}^{-3}$ , "measured" and "calculated" values are about equal ( $0.016 \text{ m}^2/\text{V-s}$ ).

With regard to diffusion, the problem is one involving the nonsteady-state diffusion of B into the Si, wherein we have to solve for temperature. Temperature is incorporated into the diffusion coefficient expression given in the problem. But we must first employ the solution to Fick's second law for constant surface composition boundary conditions, Equation (5.5); in this expression  $C_o$  is taken to be zero inasmuch as the problem stipulates that the initial boron concentration may be neglected. Thus,

$$\frac{C_x - C_o}{C_s - C_o} = 1 - \operatorname{erf}\left(\frac{x}{2\sqrt{Dt}}\right)$$

$$\frac{4.0 \times 10^{23} \text{ m}^{-3} - 0}{1.0 \times 10^{25} \text{ m}^{-3} - 0} = 1 - \operatorname{erf}\left(\frac{x}{2\sqrt{Dt}}\right)$$

which reduces to

$$0.96 = \operatorname{erf}\left(\frac{x}{2\sqrt{Dt}}\right)$$

In order to solve this expression for a value  $\frac{x}{2\sqrt{Dt}}$  of it is necessary to interpolate using data in

Table 5.1. Thus

$z$	$\text{erf}(z)$
1.4	0.9523
$z$	0.9600
1.5	0.9661

$$\frac{z - 1.4}{1.5 - 1.4} = \frac{0.9600 - 0.9523}{0.9661 - 0.9523}$$

From which,  $z = 1.4558$ ; which is to say

$$1.4558 = \frac{x}{2\sqrt{Dt}}$$

Inasmuch as there are 3600 s/h (=  $t$ ) and  $x = 0.2 \mu\text{m} (= 2 \times 10^{-7} \text{ m})$  the above equation becomes

$$1.4558 = \frac{2 \times 10^{-7} \text{ m}}{2\sqrt{(D)(3600 \text{ s})}}$$

Which gives  $D = 1.31 \times 10^{-18} \text{ m}^2/\text{s}$ . However, equating this value to the expression for  $D$  given in the problem gives

$$D = 1.31 \times 10^{-18} \text{ m}^2/\text{s} = 2.4 \times 10^{-4} \exp\left[-\frac{347,000 \text{ J/mol}}{(8.31 \text{ J/mol-K})(T)}\right]$$

And, upon solving for the temperature,  $T = 1271 \text{ K} = 998^\circ\text{C}$ .

18.D6 This problem asks, for the nonstoichiometric  $\text{Fe}_{(1-x)}\text{O}$ , given the electrical conductivity ( $2000 \text{ m}^2/\text{V-s}$ ) and hole mobility ( $1.0 \times 10^{-5} \text{ m}^2/\text{V-s}$ ) that we determine the value of  $x$ . It is first necessary to compute the number of holes per unit volume ( $p$ ) using Equation (18.17). Thus

$$p = \frac{\sigma}{|e|\mu_h}$$

$$= \frac{2000 (\Omega - m)^{-1}}{(1.0 \times 10^{-5} \text{ m}^2 / V - s)(1.602 \times 10^{-19} \text{ C})} = 1.25 \times 10^{27} \text{ holes/m}^3$$

Inasmuch as it is assumed that the vacancies are saturated, the number of vacancies is also  $1.25 \times 10^{27} \text{ m}^{-3}$ . Next, it is possible to compute the number of vacancies per unit cell by taking the product of the number of vacancies per cubic meter times the volume of a unit cell, which volume is just the unit cell edge length (0.437 nm) cubed. Thus

$$\frac{\# \text{ vacancies}}{\text{unit cell}} = (1.25 \times 10^{27} \text{ m}^{-3})(0.437 \times 10^{-9} \text{ m})^3 = 0.10$$

A unit cell for the sodium chloride structure (Figure 12.2) contains the equivalent of four cations and four anions. Thus, if we take as a basis for this problem 10 unit cells, there will be one vacancy, 40  $\text{O}^{2-}$  ions, and 39 iron ions (since one of the iron sites is vacant). (It should also be noted that since two  $\text{Fe}^{3+}$  ions are created for each vacancy, that of the 39 iron ions, 37 of them are  $\text{Fe}^{2+}$  and 2 of them are  $\text{Fe}^{3+}$ ). In order to find the value of  $(1 - x)$  in the chemical formula, we just take the ratio of the number of total Fe ions (39) and the number of total Fe ion sites (40). Thus

$$(1 - x) = \frac{39}{40} = 0.975$$

Or the formula for this nonstoichiometric material is  $\text{Fe}_{0.975}\text{O}$ .

18.D7 We are asked to compare silicon and gallium arsenide semiconductors relative to properties and applications.

The following are the characteristics and applications for Si: 1) being an elemental semiconductor, it is cheaper to grow in single-crystalline form; 2) because of its electron band structure, it is best used in transistors; 3) electronic processes are relatively slow due to the low mobilities for electrons and holes (Table 18.2).

For GaAs: 1) it is much more expensive to produce inasmuch as it is a compound semiconductor; 2) because of its electron band structure it is best used in light-emitting diodes and semiconducting lasers; 3) its band gap may be altered by alloying; 4) electronic processes are more rapid than in Si due to the greater mobilities of electrons and holes; 5) absorption of electromagnetic radiation is greater in GaAs, and therefore, thinner layers are required for solar cells.

18.D8W (a) This portion of the problem calls for us to search for possible materials to be used for a leadframe plate in an integrated circuit package. The requirements are (1) that the material be highly electrically conductive--i.e., an electrical conductivity of greater than  $10 \times 10^6 (\Omega\text{-m})^{-1}$  [or, alternatively, an electrical resistivity less than  $1.0 \times 10^{-7} (\Omega\text{-m})$ ]; (2) that it have a coefficient of thermal expansion between  $2 \times 10^{-6}$  and  $10 \times 10^{-6} (\text{°C})^{-1}$ ; and (3) it must also be a thermal conductor having a thermal conductivity of at least 100 W/m-K. When a combination query is performed on the CD-ROM for

$$\begin{aligned} \rho_e &< 1.0 \times 10^{-7} (\Omega\text{-m}) \\ 2 \times 10^{-6} (\text{°C})^{-1} &< \alpha_l < 10 \times 10^{-6} (\text{°C})^{-1} \\ \mathbf{k} &> 100 \text{ W/m-K} \end{aligned}$$

no materials are found to simultaneously satisfy all three criteria.

(b) Now we are asked to search for insulating materials to be used for the leadframe plate. The requirements are as follows: (1) an electrical conductivity less than  $10^{-10} (\Omega\text{-m})^{-1}$  [equivalently, an electrical resistivity greater than  $10^{10} (\Omega\text{-m})$ ]; a coefficient of thermal expansion between  $2 \times 10^{-6}$  and  $10 \times 10^{-6} (\text{°C})^{-1}$ ; and (3) a thermal conductivity greater than 30 W/m-K. When a combination query is performed on the CD-ROM for

$$\begin{aligned} \rho_e &> 10^{10} (\Omega\text{-m}) \\ 2 \times 10^{-6} (\text{°C})^{-1} &< \alpha_l < 10 \times 10^{-6} (\text{°C})^{-1} \\ \mathbf{k} &> 30 \text{ W/m-K} \end{aligned}$$

no materials are found to simultaneously satisfy all three criteria.

## CHAPTER 19

### THERMAL PROPERTIES

#### PROBLEM SOLUTIONS

19.1 The energy,  $E$ , required to raise the temperature of a given mass of material,  $m$ , is the product of the specific heat, the mass of material, and the temperature change,  $\Delta T$ , as

$$E = c_p m (\Delta T)$$

The  $\Delta T$  is equal to  $100^\circ\text{C} - 20^\circ\text{C} = 80^\circ\text{C}$  ( $= 80\text{ K}$ ), while the mass is 2 kg, and the specific heats are presented in Table 19.1. Thus,

$$E(\text{aluminum}) = (900\text{ J/kg-K})(2\text{ kg})(80\text{ K}) = 1.44 \times 10^5\text{ J}$$

$$E(\text{steel}) = (486\text{ J/kg-K})(2\text{ kg})(80\text{ K}) = 7.78 \times 10^4\text{ J}$$

$$E(\text{glass}) = (840\text{ J/kg-K})(2\text{ kg})(80\text{ K}) = 1.34 \times 10^5\text{ J}$$

$$E(\text{HDPE}) = (1850\text{ J/kg-K})(2\text{ kg})(80\text{ K}) = 2.96 \times 10^5\text{ J}$$

19.2 We are asked to determine the temperature to which 10  $\text{lb}_m$  of brass initially at  $25^\circ\text{C}$  would be raised if 65 Btu of heat is supplied. This is accomplished by utilization of a modified form of Equation (19.1) as

$$\Delta T = \frac{\Delta Q}{m c_p}$$

in which  $\Delta Q$  is the amount of heat supplied,  $m$  is the mass of the specimen, and  $c_p$  is the specific heat. From Table 19.1,  $c_p = 375\text{ J/kg-K}$ , which in Customary U.S. units is just

$$c_p = (375\text{ J/kg-K}) \left( \frac{2.39 \times 10^{-4}\text{ Btu/lb}_m \cdot ^\circ\text{F}}{1\text{ J/kg-K}} \right) = 0.090\text{ Btu/lb}_m \cdot ^\circ\text{F}$$

Thus

$$\Delta T = \frac{65 \text{ Btu}}{(10 \text{ lb}_m)(0.090 \text{ Btu/lb}_m \cdot ^\circ\text{F})} = 72.2^\circ\text{F}$$

and

$$T_f = T_o + \Delta T = 77^\circ\text{F} + 72.2^\circ\text{F} = 149.2^\circ\text{F} \quad (65.1^\circ\text{C})$$

19.3 (a) This problem asks that we determine the heat capacities at constant pressure,  $C_p$ , for copper, iron, gold, and nickel. All we need do is multiply the  $c_p$  values in Table 19.1 by the atomic weight, taking into account the conversion from grams to kilograms. Thus, for Cu

$$C_p = (386 \text{ J/kg-K})(1 \text{ kg}/1000 \text{ g})(63.55 \text{ g/mol}) = 24.5 \text{ J/mol-K}$$

For Fe

$$C_p = (448 \text{ J/kg-K})(1 \text{ kg}/1000 \text{ g})(55.85 \text{ g/mol}) = 25.0 \text{ J/mol-K}$$

For Au

$$C_p = (128 \text{ J/kg-K})(1 \text{ kg}/1000 \text{ g})(196.97 \text{ g/mol}) = 25.2 \text{ J/mol-K}$$

For Ni

$$C_p = (443 \text{ J/kg-K})(1 \text{ kg}/1000 \text{ g})(58.69 \text{ g/mol}) = 26.0 \text{ J/mol-K}$$

(b) These values of  $C_p$  are very close to one another because room temperature is considerably above the Debye temperature for these metals, and, therefore, the values of  $C_p$  should be about equal to  $3R$  [(3)(8.31 J/mol-K) = 24.9 J/mol-K], which is indeed the case for all four of these metals.

19.4 (a) For aluminum,  $C_v$  at 50 K may be approximated by Equation (19.2), since this temperature is significantly below the Debye temperature. The value of  $C_v$  at 30 K is given, and thus, we may compute the constant  $A$  as

$$A = \frac{C_v}{T^3} = \frac{0.81 \text{ J/mol-K}}{(30 \text{ K})^3} = 3 \times 10^{-5} \text{ J/mol-K}^4$$

Therefore, at 50 K

$$C_V = AT^3 = (3 \times 10^{-5} \text{ J/mol-K}^4)(50 \text{ K})^3 = 3.75 \text{ J/mol-K}$$

and

$$c_v = (3.75 \text{ J/mol-K})(1 \text{ mol}/26.98 \text{ g})(1000 \text{ g/kg}) = 139 \text{ J/kg-K}$$

(b) Since 425 K is above the Debye temperature, a good approximation for  $C_V$  is

$$C_V = 3R$$

$$= (3)(8.31 \text{ J/mol-K}) = 24.9 \text{ J/mol-K}$$

And, converting this to specific heat

$$c_v = (24.9 \text{ J/mol-K})(1 \text{ mol}/26.98 \text{ g})(1000 \text{ g/kg}) = 925 \text{ J/kg-K}$$

19.5 For copper, we want to compute the Debye temperature,  $\theta_D$ , given the expression for  $A$  in Equation (19.2) and the heat capacity at 10 K. First of all, let us determine the magnitude of  $A$ , as

$$\begin{aligned} A &= \frac{C_V}{T^3} \\ &= \frac{(0.78 \text{ J/mol-K})(1 \text{ kg}/1000 \text{ g})(63.55 \text{ g/mol})}{(10 \text{ K})^3} \\ &= 4.96 \times 10^{-5} \text{ J/mol-K}^4 \end{aligned}$$

As stipulated in the problem

$$A = \frac{12\pi^4 R}{5\theta_D^3}$$

Or, solving for  $\theta_D$



$$\theta_D = \left( \frac{12 \pi^4 R}{5A} \right)^{1/3}$$

$$= \left[ \frac{(12)(\pi)^4 (8.31 \text{ J/mol-K})}{(5)(4.96 \times 10^{-5} \text{ J/mol-K}^4)} \right]^{1/3} = 340 \text{ K}$$

19.6 (a) The reason that  $C_V$  rises with increasing temperature at temperatures near 0 K is because, in this temperature range, the allowed vibrational energy levels of the lattice waves are far apart relative to the available thermal energy, and only a portion of the lattice waves may be excited. As temperature increases, more of the lattice waves may be excited by the available thermal energy, and, hence, the ability of the solid to absorb energy (i.e., the magnitude of the heat capacity) increases.

(b) At temperatures far removed from 0 K,  $C_V$  becomes independent of temperature because all of the lattice waves have been excited and the energy required to produce an incremental temperature change is nearly constant.

19.7 The two metals from which a bimetallic strip is constructed have different coefficients of thermal expansion. Consequently, a change in temperature will cause the strip to bend. For a thermostat that operates a furnace, as the temperature drops below a lower limit, the bimetallic strip bends so as to make an electrical contact, thus, turning on the furnace. With rising temperature, the strip bends in the opposite direction, breaking the contact (and turning the furnace off) when an upper-limit temperature is exceeded.

19.8 (a) A brass lid on a glass canning jar will loosen when heated because brass has the greater coefficient of thermal expansion [ $20 \times 10^{-6} (\text{°C})^{-1}$  versus approximately  $9 \times 10^{-6} (\text{°C})^{-1}$  for glass, Table 19.1].

(b) If the ring is made of tungsten instead of brass, the ring will tighten upon heating inasmuch as the glass will expand more than tungsten. The values of  $\alpha_l$  for glass and tungsten are  $9 \times 10^{-6} (\text{°C})^{-1}$  and  $4.5 \times 10^{-6} (\text{°C})^{-1}$ , respectively.

19.9 In order to determine the change in length of the aluminum wire, we must employ Equation (19.3b) as

$$\Delta l = l_0 \alpha_l \Delta T$$

$$\begin{aligned}
&= (10 \text{ m}) \left[ 23.6 \times 10^{-6} (\text{°C})^{-1} \right] (-1\text{°C} - 38\text{°C}) \\
&= -9.2 \times 10^{-3} \text{ m} = -9.2 \text{ mm} \quad (-0.36 \text{ in.})
\end{aligned}$$

19.10 The linear coefficient of thermal expansion for this material may be determined using Equation (19.3b) as

$$\begin{aligned}
\alpha_l &= \frac{\Delta l}{l_o \Delta T} = \frac{0.2 \times 10^{-3} \text{ m}}{(0.1 \text{ m})(100\text{°C} - 20\text{°C})} \\
&= 25.0 \times 10^{-6} (\text{°C})^{-1}
\end{aligned}$$

19.11 The phenomenon of thermal expansion using the potential energy-versus-interatomic spacing curve is explained in Section 19.3.

19.12 (a) In this portion of the problem we are asked to determine the density of copper at 1000°C on the basis of thermal expansion considerations. The basis for this determination will be 1 cm<sup>3</sup> of material at 20°C, which has a mass of 8.940 g; it is assumed that this mass will remain constant upon heating to 1000°C. Let us compute the volume expansion of this cubic centimeter of copper as it is heated to 1000°C. A volume expansion expression is given in Equation (19.4)--viz.,

$$\frac{\Delta V}{V_o} = \alpha_v \Delta T$$

or

$$\Delta V = V_o \alpha_v \Delta T$$

Also,  $\alpha_v = 3\alpha_l$ , as stipulated in the problem. The value of  $\alpha_l$  given in Table 19.1 for copper is  $17.0 \times 10^{-6} (\text{°C})^{-1}$ . Therefore, the volume,  $V$ , of this specimen of Cu at 1000°C is just

$$\begin{aligned}
V &= V_o + \Delta V = V_o (1 + \alpha_v \Delta T) \\
&= (1 \text{ cm}^3) \left\{ 1 + (3) \left[ 17.0 \times 10^{-6} (\text{°C})^{-1} \right] (1000\text{°C} - 20\text{°C}) \right\} \\
&= 1.04998 \text{ cm}^3
\end{aligned}$$

Thus, the density is just the 8.940 g divided by this new volume--i.e.,

$$\rho = \frac{8.940 \text{ g}}{1.04998 \text{ cm}^3} = 8.514 \text{ g/cm}^3$$

- (b) Now we are asked to compute the density at 1000°C taking into consideration the creation of vacancies, which will further lower the density. This determination requires that we calculate the number of vacancies using Equation (4.1). But it first becomes necessary to compute the number of Cu atoms per cubic centimeter (**N**) using Equation (4.2). Thus,

$$\begin{aligned} N &= \frac{N_A \rho_{\text{Cu}}}{A_{\text{Cu}}} \\ &= \frac{(6.023 \times 10^{23} \text{ atoms/mol})(8.514 \text{ g/cm}^3)}{63.55 \text{ g/mol}} \\ &= 8.07 \times 10^{22} \text{ atoms/cm}^3 \end{aligned}$$

Now the total number of vacancies, **N<sub>v</sub>**, [Equation (4.1)] is just

$$\begin{aligned} N_v &= N \exp\left(-\frac{Q_v}{kT}\right) \\ &= (8.07 \times 10^{22} \text{ atoms/cm}^3) \exp\left[-\frac{0.90 \text{ eV/atom}}{(8.62 \times 10^{-5} \text{ eV/K})(1273 \text{ K})}\right] \\ &= 2.212 \times 10^{19} \text{ vacancies/cm}^3 \end{aligned}$$

We want to determine the number of vacancies per unit cell, which is possible if the unit cell volume is multiplied by **N<sub>v</sub>**. The unit cell volume (**V<sub>C</sub>**) may be calculated using Equation (3.5) taking **n** = 4 inasmuch as Cu has an FCC crystal structure. Thus

$$V_C = \frac{nA_{\text{Cu}}}{\rho_{\text{Cu}} N_A}$$

$$= \frac{(4 \text{ atoms/unit cell})(63.55 \text{ g/mol})}{(8.514 \text{ g/cm}^3)(6.023 \times 10^{23} \text{ atoms/mol})}$$

$$= 4.957 \times 10^{-23} \text{ cm}^3/\text{unit cell}$$

Now, the number of vacancies per unit cell,  $n_v$ , is just

$$n_v = N_v V_C$$

$$= (2.212 \times 10^{19} \text{ vacancies/cm}^3)(4.957 \times 10^{-23} \text{ cm}^3/\text{unit cell})$$

$$= 0.001096 \text{ vacancies/unit cell}$$

What this means is that instead of there being 4.0000 atoms per unit cell, there are only 4.0000 - 0.001096 = 3.9989 atoms per unit cell. And, finally, the density may be computed using Equation (3.5) taking  $n = 3.998904$

$$\rho_{\text{Cu}} = \frac{nA_{\text{Cu}}}{V_C N_A}$$

$$= \frac{(3.998904 \text{ atoms/unit cell})(63.55 \text{ g/mol})}{(4.957 \times 10^{-23} \text{ cm}^3/\text{unit cell})(6.023 \times 10^{23} \text{ atoms/mol})}$$

$$= 8.512 \text{ g/cm}^3$$

Thus, the influence of the vacancies is almost insignificant--their presence reduces the density by only  $0.002 \text{ g/cm}^3$ .

19.13 This problem asks that we calculate the values of  $c_v$  for aluminum and iron at room temperature using Equation (19.10), the data in Table 19.1, given that  $\alpha_v = 3\alpha_l$ , and given values of the compressibility. From Equation (19.10)

$$c_v = c_p - \frac{\alpha_v^2 v_0 T}{\beta}$$

From Table 19.1

$$c_p(\text{Al}) = 900 \text{ J/kg-K}$$

$$c_p(\text{Fe}) = 448 \text{ J/kg-K}$$

$$\alpha_v(\text{Al}) = (3)[23.6 \times 10^{-6} (\text{°C})^{-1}] = 7.08 \times 10^{-5} (\text{°C})^{-1}$$

$$\alpha_v(\text{Fe}) = (3)[11.8 \times 10^{-6} (\text{°C})^{-1}] = 3.54 \times 10^{-5} (\text{°C})^{-1}$$

The specific volume is just the reciprocal of the density; thus

$$v_o(\text{Al}) = \frac{1}{\rho} = \left( \frac{1}{2.71 \text{ g/cm}^3} \right) \left( \frac{1000 \text{ g}}{\text{kg}} \right) \left( \frac{1 \text{ m}}{100 \text{ cm}} \right)^3 = 3.69 \times 10^{-4} \text{ m}^3/\text{kg}$$

$$v_o(\text{Fe}) = \left( \frac{1}{7.87 \text{ g/cm}^3} \right) \left( \frac{1000 \text{ g}}{\text{kg}} \right) \left( \frac{1 \text{ m}}{100 \text{ cm}} \right)^3 = 1.27 \times 10^{-4} \text{ m}^3/\text{kg}$$

Therefore,

$$c_v(\text{Al}) = c_p(\text{Al}) - \frac{\alpha_v^2(\text{Al}) v_o(\text{Al}) T}{\beta(\text{Al})}$$

$$= 900 \text{ J/kg-K} - \frac{[7.08 \times 10^{-5} (\text{°C})^{-1}]^2 (3.69 \times 10^{-4} \text{ m}^3/\text{kg}) (293 \text{ K})}{1.77 \times 10^{-11} (\text{N/m}^2)^{-1}}$$

$$869 \text{ J/kg-K}$$

And

$$c_v(\text{Fe}) = 448 \text{ J/kg-K} - \frac{[3.54 \times 10^{-5} (\text{°C})^{-1}]^2 (1.27 \times 10^{-4} \text{ m}^3/\text{kg}) (293 \text{ K})}{2.65 \times 10^{-12} (\text{N/m}^2)^{-1}}$$

$$430 \text{ J/kg-K}$$

19.14 This problem asks for us to determine the temperature to which a cylindrical rod of tungsten 15.025 mm in diameter must be heated in order for it to just fit into a 15.000 mm diameter circular hole in a plate of 1025 steel (which, of course, is also heated), assuming that the initial temperature is 25°C. This requires the use of Equation (19.3a), which is applied to the diameters of both the rod and hole. That is

$$\frac{d_f - d_o}{d_o} = \alpha_1 (T_f - T_o)$$

Solving this expression for  $d_f$  yields

$$d_f = d_o [1 + \alpha_1 (T_f - T_o)]$$

Now all we need do is to establish expressions for  $d_f(\text{steel})$  and  $d_f(\text{W})$ , set them equal to one another, and solve for  $T_f$ . According to Table 19.1,  $\alpha_1(\text{steel}) = 12.0 \times 10^{-6} (\text{°C})^{-1}$  and  $\alpha_1(\text{W}) = 4.5 \times 10^{-6} (\text{°C})^{-1}$ . Thus

$$d_f(\text{steel}) = d_f(\text{W})$$

$$\begin{aligned} & (15.000 \text{ mm}) \left[ 1 + \left\{ 2.0 \times 10^{-6} (\text{°C})^{-1} \right\} (T_f - 25\text{°C}) \right] \\ &= (15.025 \text{ mm}) \left[ 1 + \left\{ 4.5 \times 10^{-6} (\text{°C})^{-1} \right\} (T_f - 25\text{°C}) \right] \end{aligned}$$

Now solving for  $T_f$  gives  $T_f = 222.4\text{°C}$

19.15 On a cold day, the metal door handle feels colder than the plastic steering wheel because metal has the higher thermal conductivity, and, therefore, conducts heat away from one's skin more rapidly.

19.16 (a) The steady-state heat flux through the plate may be computed using Equation (19.5); the thermal conductivity for steel, found in Table 19.1, is 51.9 W/m-K. Therefore,

$$\begin{aligned} q &= -k \frac{\Delta T}{\Delta x} \\ &= -(51.9 \text{ W/m-K}) \frac{(373 \text{ K} - 573 \text{ K})}{10 \times 10^{-3} \text{ m}} \\ &= 1.04 \times 10^6 \text{ W/m}^2 \end{aligned}$$

(b) Let  $dQ/dt$  represent the total heat loss such that

$$\frac{dQ}{dt} = qAt$$

where **A** and **t** are the cross-sectional area and time, respectively. Thus,

$$\begin{aligned} \frac{dQ}{dt} &= (1.04 \times 10^6 \text{ J/s} \cdot \text{m}^2)(0.25 \text{ m}^2)(60 \text{ s/min})(60 \text{ min/h}) \\ &= 9.3 \times 10^8 \text{ J/h} \quad (8.9 \times 10^5 \text{ Btu/h}) \end{aligned}$$

(c) If soda-lime glass is used ( $k = 1.7 \text{ W/m} \cdot \text{K}$ )(Table 19.1),

$$\begin{aligned} \frac{dQ}{dt} &= -kAt \frac{\Delta T}{\Delta x} \\ &= - (1.7 \text{ J/s} \cdot \text{m} \cdot \text{K})(0.25 \text{ m}^2)(3600 \text{ s/h}) \left( \frac{-200 \text{ K}}{10 \times 10^{-3} \text{ m}} \right) \\ &= 3.06 \times 10^7 \text{ J/h} \quad (2.9 \times 10^4 \text{ Btu/h}) \end{aligned}$$

(d) If the thickness of the steel is increased to 20 mm

$$\begin{aligned} \frac{dQ}{dt} &= -kAt \frac{\Delta T}{\Delta x} \\ &= - (51.9 \text{ W/m} \cdot \text{K})(0.25 \text{ m}^2)(3600 \text{ s/h}) \left( \frac{-200 \text{ K}}{20 \times 10^{-3} \text{ m}} \right) \\ &= 4.7 \times 10^8 \text{ J/h} \quad (4.5 \times 10^5 \text{ Btu/h}) \end{aligned}$$

19.17 (a) Equation (19.7) is not valid for ceramic and polymeric materials since, in the development of this expression, it is assumed that free electrons are responsible for both electrical and thermal conduction. Such is the case for most metals. For ceramics and polymers, free electrons are the primary contributors to the electrical conductivity. However, free electrons do not contribute significantly to the thermal conductivity. For ceramics, thermal conduction is primarily by means of phonons; for polymers, the energy transfer is made by chain vibrations, translations, and rotations.

(b) Estimated room-temperature values of  $L$ , in  $\Omega\text{-W}/(\text{K})^2$ , for the several materials are determined below. Electrical conductivity values were determined by taking reciprocals of the resistivities given in Table B.9, Appendix B; thermal conductivities are taken from Table B.7 in the same appendix.

For zirconia (3 mol%  $\text{Y}_2\text{O}_3$ )

$$L = \frac{k}{\sigma T} = \frac{2.65 \text{ W/m-K}}{\left[10^{-10} (\Omega\text{-m})^{-1}\right] (293 \text{ K})} = 9.0 \times 10^7 \text{ } \Omega\text{-W}/\text{K}^2$$

For synthetic diamond

$$L = \frac{3150 \text{ W/m-K}}{\left[66.7 (\Omega\text{-m})^{-1}\right] (293 \text{ K})} = 0.161 \text{ } \Omega\text{-W}/\text{K}^2$$

For intrinsic gallium arsenide

$$L = \frac{45.5 \text{ W/m-K}}{\left[10^{-6} (\Omega\text{-m})^{-1}\right] (293 \text{ K})} = 1.55 \times 10^5 \text{ } \Omega\text{-W}/\text{K}^2$$

For polyethylene terephthalate (PET)

$$L = \frac{0.15 \text{ W/m-K}}{\left[10^{-12} (\Omega\text{-m})^{-1}\right] (293 \text{ K})} = 5.12 \times 10^8 \text{ } \Omega\text{-W}/\text{K}^2$$

For silicone

$$L = \frac{0.23 \text{ W/m-K}}{\left[10^{-13} (\Omega\text{-m})^{-1}\right] (293 \text{ K})} = 7.8 \times 10^9 \text{ } \Omega\text{-W}/\text{K}^2$$

19.18 (a) The thermal conductivity of a single crystal is greater than a polycrystalline specimen of the same material because both phonons and free electrons are scattered at grain boundaries, thus decreasing the efficiency of thermal transport.

(b) The thermal conductivity of a plain carbon steel is greater than that for a stainless steel because the stainless steel has a much higher concentration of alloying elements. Atoms of these alloying elements serve as scattering centers for the free electrons that are involved in the thermal transport process.



- 19.19 Thermal conductivities are higher for crystalline than for noncrystalline ceramics because, for noncrystalline, phonon scattering, and thus the resistance to heat transport, is much more effective due to the highly disordered and irregular atomic structure.
- 19.20 Metals are typically better thermal conductors than ceramic materials because, for metals, most of the heat is transported by free electrons (of which there are relatively large numbers). In ceramic materials, the primary mode of thermal conduction is via phonons, and phonons are more easily scattered than are free electrons.
- 19.21 (a) Porosity decreases the thermal conductivity of ceramic and polymeric materials because the thermal conductivity of a gas phase that occupies pore space is extremely small relative to that of the solid material. Furthermore, contributions from gaseous convection are generally insignificant.
- (b) Increasing the degree of crystallinity of a semicrystalline polymer enhances its thermal conductivity; the vibrations, rotations, etc. of the molecular chains are more effective modes of thermal transport when a crystalline structure prevails.
- 19.22 For some ceramic materials, the thermal conductivity first decreases with rising temperature because the scattering of lattice vibrations increases with temperature. At higher temperatures, the thermal conductivity will increase for some ceramics that are porous because radiant heat transfer across pores may become important, which process increases with rising temperature.
- 19.23 This question asks for us to decide, for each of several pairs of materials, which has the larger thermal conductivity and why.
- (a) Pure silver has a larger conductivity than sterling silver because the impurity atoms in the latter lead to a greater degree of free electron scattering.
- (b) Polycrystalline silica has a larger conductivity than fused silica because fused silica is noncrystalline and lattice vibrations are more effectively scattered in noncrystalline materials.
- (c) The linear polyethylene has a larger conductivity than the lightly branched polyethylene because the former will have a higher degree of crystallinity by virtue of its linear molecular structure. Since heat transfer is accomplished by molecular chain vibrations, and the coordination of these vibrations increases with percent crystallinity, the higher the crystallinity, the greater the thermal conductivity.
- (d) The isotactic polypropylene has a larger thermal conductivity than the atactic polypropylene because isotactic polymers have a higher degree of crystallinity. The influence of crystallinity on conductivity is explained in part (c).

19.24 This problem asks that we treat a porous material as a composite wherein one of the phases is a pore phase, and that we estimate upper and lower limits for the room-temperature thermal conductivity of an aluminum oxide material having a 0.25 volume fraction of pores. The upper limit of  $k$  ( $k_{\text{upper}}$ ) may be determined using Equation (16.1) with thermal conductivity substituted for the elastic modulus,  $E$ . From Table 19.1, the value of  $k$  for  $\text{Al}_2\text{O}_3$  is 39 W/m-K, while for still air in the pore phase,  $k = 0.02$  W/m-K. Thus

$$k_{\text{upper}} = V_p k_{\text{air}} + V_{\text{Al}_2\text{O}_3} k_{\text{Al}_2\text{O}_3}$$

$$= (0.25)(0.02 \text{ W/m-K}) + (0.75)(39 \text{ W/m-K}) = 29.3 \text{ W/m-K}$$

For the lower limit we employ a modification of Equation (16.2) as

$$k_{\text{lower}} = \frac{k_{\text{air}} k_{\text{Al}_2\text{O}_3}}{V_p k_{\text{Al}_2\text{O}_3} + V_{\text{Al}_2\text{O}_3} k_{\text{air}}}$$

$$= \frac{(0.02 \text{ W/m-K})(39 \text{ W/m-K})}{(0.25)(39 \text{ W/m-K}) + (0.75)(0.02 \text{ W/m-K})} = 0.080 \text{ W/m-K}$$

19.25 (a) The units of  $D_T$  are

$$D_T = \frac{k(\text{J/s-m-K})}{\rho(\text{kg/m}^3)c_p(\text{J/kg-K})} = \text{m}^2/\text{s}$$

(b) Values of  $D_T$  for the several materials are given below:

For aluminum

$$D_T = \frac{k}{\rho c_p} = \frac{247 \text{ W/m-K}}{(2.70 \times 10^3 \text{ kg/m}^3)900 \text{ J/kg-K}} = 1.0 \times 10^{-4} \text{ m}^2/\text{s}$$

For steel

$$D_T = \frac{51.9 \text{ W/m-K}}{(7.9 \times 10^3 \text{ kg/m}^3)486 \text{ J/kg-K}} = 1.4 \times 10^{-5} \text{ m}^2/\text{s}$$

For aluminum oxide

$$D_T = \frac{39 \text{ W/m-K}}{(4.0 \times 10^3 \text{ kg/m}^3)775 \text{ J/kg-K}} = 1.26 \times 10^{-5} \text{ m}^2/\text{s}$$

For soda-lime glass

$$D_T = \frac{1.7 \text{ W/m-K}}{(2.5 \times 10^3 \text{ kg/m}^3)840 \text{ J/kg-K}} = 8.1 \times 10^{-7} \text{ m}^2/\text{s}$$

For polystyrene

$$D_T = \frac{0.13 \text{ W/m-K}}{(1.05 \times 10^3 \text{ kg/m}^3)1170 \text{ J/kg-K}} = 1.06 \times 10^{-7} \text{ m}^2/\text{s}$$

For nylon 6,6

$$D_T = \frac{0.24 \text{ W/m-K}}{(1.14 \times 10^3 \text{ kg/m}^3)1670 \text{ J/kg-K}} = 1.3 \times 10^{-7} \text{ m}^2/\text{s}$$

19.26 We want to show that Equation (19.8) is valid beginning with Equation (19.3). Upon examination of Equation (19.3b),

$$\frac{\Delta l}{l_0} = \alpha_l \Delta T$$

it may be noted that the term on the left-hand side is the same expression as that for the definition of engineering strain [Equation (6.2)]. Furthermore, elastic stress and strain are related through Hooke's law, Equation (6.5). Making appropriate substitutions and algebraic manipulations gives

$$\frac{\Delta l}{l_0} = \varepsilon = \frac{\sigma}{E} = \alpha_l \Delta T$$

Or

$$\sigma = E\alpha_l \Delta T$$

which is the form of Equation (19.8).

19.27 (a) Thermal stresses may be introduced into a structure by rapid heating or cooling because temperature gradients will be established across the cross section due to more rapid temperature changes at the surface than within the interior; thus, the surface will expand or contract at a different rate than the interior and since this surface expansion or contraction will be restrained by the interior, stresses will be introduced.

(b) For cooling, the surface stresses will be tensile in nature since the interior contracts to a lesser degree than the cooler surface.

(c) For heating, the surface stresses will be compressive in nature since the interior expands to a lesser degree than the hotter surface.

(d) For a ceramic material, thermal shock is more likely for rapid cooling since the surface stresses are tensile in nature which will lead to stress concentrations at surface flaws that are present. No such stress amplification will result for compressive stresses which are established at the surface for rapid heating.

19.28 (a) We are asked to compute the magnitude of the stress within a steel rod that is heated while its ends are maintained rigid. To do this we employ Equation (19.8) as

$$\begin{aligned}\sigma &= E\alpha_l(T_o - T_f) \\ &= (207 \times 10^9 \text{ N/m}^2) [2.0 \times 10^{-6} (\text{°C})^{-1}] [20\text{°C} - 80\text{°C}] \\ &= -150 \text{ MPa} \quad (-21,600 \text{ psi})\end{aligned}$$

The stress will be compressive since its sign is negative.

(b) The stress will be the same [- 150 MPa (- 21,800 psi)], since stress is independent of bar length.

(c) Upon cooling the indicated amount, the stress becomes

$$\begin{aligned}\sigma &= E\alpha_l(T_o - T_f) \\ &= (207 \times 10^9 \text{ N/m}^2) [2.0 \times 10^{-6} (\text{°C})^{-1}] [20\text{°C} - (-10\text{°C})] \\ &= +74.5 \text{ MPa} \quad (+10,800 \text{ psi})\end{aligned}$$

This stress will be tensile since its sign is positive.

19.29 We want to heat the copper wire in order to reduce the stress level from 70 MPa to 35 MPa; in doing so, we reduce the stress in the wire by 70 MPa - 35 MPa = 35 MPa, which stress will be a compressive one (i.e.,  $\sigma = -35$  MPa). Solving for  $T_f$  from Equation (19.8)

$$\begin{aligned} T_f &= T_o - \frac{\sigma}{E\alpha_1} \\ &= 20^\circ\text{C} - \frac{-35 \text{ MPa}}{(110 \times 10^3 \text{ MPa})[17 \times 10^{-6} (\text{°C})^{-1}]} \\ &= 20^\circ\text{C} + 19^\circ\text{C} = 39^\circ\text{C} \quad (101^\circ\text{F}) \end{aligned}$$

19.30 This problem asks for us to determine the change in diameter of a cylindrical brass rod 150.00 mm long and 10.000 mm in diameter when it is heated from 20°C to 160°C while its ends are maintained rigid. There will be two contributions to the diameter increase of the rod; the first is due to thermal expansion (which will be denoted as  $\Delta d_1$ ), while the second is from Poisson's lateral expansion as a result of elastic deformation from stresses that are established from the inability of the rod to elongate as it is heated (denoted as  $\Delta d_2$ ). The magnitude of  $\Delta d_1$  may be computed using Equation (19.3b) as

$$\Delta d_1 = d_o \alpha_1 (T_f - T_o)$$

From Table 19.1 the value of  $\alpha_1$  for brass is  $20.0 \times 10^{-6} (\text{°C})^{-1}$ . Thus,

$$\begin{aligned} \Delta d_1 &= (10.000 \text{ mm}) [20.0 \times 10^{-6} (\text{°C})^{-1}] (160^\circ\text{C} - 20^\circ\text{C}) \\ &= 0.0280 \text{ mm} \end{aligned}$$

For  $\Delta d_2$ , we may calculate the stress using Equation (19.8), and the resulting longitudinal strain using Equation (6.5), and finally the lateral strain (and  $\Delta d_2$ ) using Equation (6.8). Hence

$$\frac{\Delta d_2}{d_o} = -\nu \varepsilon_z = -\frac{\nu \sigma}{E} = -\frac{\nu E \alpha_1 (T_o - T_f)}{E} = -\nu \alpha_1 (T_o - T_f)$$

Solving for  $\Delta d_2$  and realizing that  $\nu = 0.34$  (Table 6.1) yields

$$\begin{aligned}\Delta d_2 &= -d_o \nu \alpha_1 (T_o - T_f) \\ &= -(10.000 \text{ mm})(0.34) \left[ 20.0 \times 10^{-6} (\text{°C})^{-1} \right] 20\text{°C} - 160\text{°C} \\ &= 0.0095 \text{ mm}\end{aligned}$$

Finally, the total  $\Delta d$  is just  $\Delta d_1 + \Delta d_2 = 0.0280 \text{ mm} + 0.0095 \text{ mm} = 0.0375 \text{ mm}$ .

19.31 This problem asks for us to determine to what temperature a cylindrical rod of nickel 120.00 mm long and 12.000 mm in diameter must be cooled from 70°C in order to have a 0.023 mm reduction in diameter if the rod ends are maintained rigid. There will be two contributions to the diameter decrease of the rod; the first is due to thermal contraction (which will be denoted as  $\Delta d_1$ ), while the second is from Poisson's lateral contraction as a result of elastic deformation from stresses that are established from the inability of the rod to contract as it is cooled (denoted as  $\Delta d_2$ ). The magnitude of  $\Delta d_1$  may be computed using Equation (19.3b) as

$$\Delta d_1 = d_o \alpha_1 (T_f - T_o)$$

Furthermore, for  $\Delta d_2$ , we may calculate the stress using Equation (19.8), and the resulting longitudinal strain from Equation (6.5), and finally the lateral strain (and  $\Delta d_2$ ) using Equation (6.8).

Thus

$$\frac{\Delta d_2}{d_o} = -\nu \varepsilon_z = -\frac{\nu \sigma}{E} = -\frac{\nu E \alpha_1 (T_o - T_f)}{E} = -\nu \alpha_1 (T_o - T_f)$$

Or

$$\Delta d_2 = -d_o \nu \alpha_1 (T_o - T_f)$$

The total  $\Delta d$  is just  $\Delta d = \Delta d_1 + \Delta d_2$ , and

$$\Delta d = d_o \alpha_1 (T_f - T_o) + d_o \nu \alpha_1 (T_f - T_o) = d_o \alpha_1 (T_f - T_o) (1 + \nu)$$

The values of  $\nu$  and  $\alpha_1$  for nickel are 0.31 and  $13.3 \times 10^{-6} (\text{°C})^{-1}$ , respectively (Tables 6.1 and 19.1).

Therefore,

$$-(0.023 \text{ mm}) = (12.000 \text{ mm}) \left[ 13.3 \times 10^{-6} (\text{°C})^{-1} \right] (T_f - 70\text{°C})(1 + 0.31)$$

Solving the above expression for  $T_f$  yields  $T_f = -40\text{°C}$ .

19.32 According to Equation (19.9), the thermal shock resistance of a ceramic piece may be enhanced by increasing the fracture strength and thermal conductivity, and by decreasing the elastic modulus and linear coefficient of thermal expansion. Of these parameters,  $\sigma_f$  and  $\alpha_l$  are the most amenable to alteration, usually by changing the composition and/or the microstructure.

### Design Problems

19.D1 For these railroad tracks, each end is allowed to expand one-half of the joint space distance, or the track may expand a total of this distance (4.6 mm). Equation (19.3a) is used to solve for  $T_f$ , where  $\alpha_l$  for the 1025 steel is found in Table 19.1 [i.e.,  $12.0 \times 10^{-6} (\text{°C})^{-1}$ ]. Thus,

$$\begin{aligned} T_f &= \frac{\Delta l}{\alpha_l l_o} + T_o \\ &= \frac{4.6 \times 10^{-3} \text{ m}}{\left[ 12.0 \times 10^{-6} (\text{°C})^{-1} \right] (11.9 \text{ m})} + 10\text{°C} \\ &= 32.2\text{°C} + 10\text{°C} = 42.2\text{°C} \quad (108\text{°F}) \end{aligned}$$

19.D2 This is really a materials selection problem in which we must decide for which of the five metals listed, the stress in the rod will not exceed 138 MPa (20,000 psi), when it is heated while its ends are mounted in rigid supports. Upon examination of Equation (19.8), it may be noted that all we need do is to compute the  $E\alpha_l\Delta T$  product for each of the candidate materials, and then note for which of them the stress is less than the stipulated maximum. (The value of  $\Delta T$  is just 80°C.) These parameters and their product for each of the alloys are tabulated below. (Modulus of elasticity values were taken from Table 6.1.)

Alloy	$\alpha_l (\text{°C})^{-1}$	E (MPa)	$\alpha_l E \Delta T$ (MPa)
Aluminum	$23.6 \times 10^{-6}$	$69 \times 10^3$	130
Copper	$17.0 \times 10^{-6}$	$110 \times 10^3$	150

Brass	$20.0 \times 10^{-6}$	$97 \times 10^3$	155
1025 Steel	$12.0 \times 10^{-6}$	$207 \times 10^3$	200
Tungsten	$4.5 \times 10^{-6}$	$407 \times 10^3$	145

Thus, aluminum is the only suitable candidate.

19.D3 (a) This portion of the problem asks that we cite the units for the thermal shock resistance parameter (**TSR**). From Equation (19.9)

$$\text{TSR} = \frac{\sigma_f (\text{N/m}^2) k (\text{W/m-K})}{E (\text{N/m}^2) \alpha_l (\text{°C})^{-1}} = \text{W/m}$$

(b) Now we are asked to rank soda-lime glass, fused silica, and silicon as to their thermal shock resistance. Thus, all we need do is calculate, for each, the value of **TSR** using Equation (19.9). Values of **E**,  $\sigma_f$ ,  $\alpha_l$ , and **k** are found, respectively, in Tables B.2, B.4, B.6, and B.7, Appendix B.

(Note: whenever a range for a property value in these tables is cited, the average of the extremes is used.)

For soda-lime glass

$$\begin{aligned} \text{TSR} &= \frac{\sigma_f k}{E \alpha_l} \\ &= \frac{(69 \text{ MPa})(1.7 \text{ W/m-K})}{(69 \times 10^3 \text{ MPa}) [9.0 \times 10^{-6} (\text{°C})^{-1}]} = 189 \text{ W/m} \end{aligned}$$

For fused silica

$$\text{TSR} = \frac{(104 \text{ MPa})(1.4 \text{ W/m-K})}{(73 \times 10^3 \text{ MPa}) [0.4 \times 10^{-6} (\text{°C})^{-1}]} = 4986 \text{ W/m}$$

And, for silicon

$$\text{TSR} = \frac{(130 \text{ MPa})(141 \text{ W/m-K})}{(129 \times 10^3 \text{ MPa}) [2.5 \times 10^{-6} (\text{°C})^{-1}]} = 56,800 \text{ W/m}$$



Thus, these materials may be ranked according to their thermal shock resistance from the greatest to the least as follows: silicon, fused silica, and soda-lime glass.

19.D4 We want to compute the maximum temperature change allowable without thermal shock for these several ceramic materials, which temperature change is a function of the fracture strength, elastic modulus, and linear coefficient of thermal expansion. These data and the  $\Delta T_f$ 's are tabulated below.

Material	$\sigma_f$ (MPa)	E (MPa)	$\alpha_l$ ( $^{\circ}\text{C}$ ) <sup>-1</sup>	$\Delta T_f$ ( $^{\circ}\text{C}$ )
Soda-lime glass	69	$69 \times 10^3$	$9.0 \times 10^{-6}$	111
Borosilicate glass	69	$70 \times 10^3$	$3.3 \times 10^{-6}$	300
Aluminum oxide (96%)	358	$303 \times 10^3$	$7.4 \times 10^{-6}$	160
Gallium arsenide	57	$85 \times 10^3$	$5.9 \times 10^{-6}$	114

## CHAPTER 20

### MAGNETIC PROPERTIES

#### PROBLEM SOLUTIONS

20.1 (a) We may calculate the magnetic field strength generated by this coil using Equation (20.1) as

$$\begin{aligned} H &= \frac{NI}{l} \\ &= \frac{(200 \text{ turns})(10 \text{ A})}{0.2 \text{ m}} = 10,000 \text{ A-turns/m} \end{aligned}$$

(b) In a vacuum, the flux density is determined from Equation (20.3). Thus,

$$\begin{aligned} B_o &= \mu_o H \\ &= (1.257 \times 10^{-6} \text{ H/m})(10,000 \text{ A-turns/m}) = 1.257 \times 10^{-2} \text{ tesla} \end{aligned}$$

(c) When a bar of titanium is positioned within the coil, we must use an expression that is a combination of Equations (20.5) and (20.6) in order to compute the flux density given the magnetic susceptibility. Inasmuch as  $\chi_m = 1.81 \times 10^{-4}$  (Table 20.2), then

$$\begin{aligned} B &= \mu_o H + \mu_o M = \mu_o H + \mu_o \chi_m H = \mu_o H(1 + \chi_m) \\ &= (1.257 \times 10^{-6} \text{ H/m})(10,000 \text{ A-turns/m})(1 + 1.81 \times 10^{-4}) \\ &\cong 1.257 \times 10^{-2} \text{ tesla} \end{aligned}$$

which is essentially the same result as part (b). This is to say that the influence of the titanium bar within the coil makes an imperceptible difference in the magnitude of the **B** field.

(d) The magnetization is computed from Equation (20.6):

$$M = \chi_m H = (1.81 \times 10^{-4})(10,000 \text{ A-turns/m}) = 1.81 \text{ A/m}$$

20.2 (a) This portion of the problem asks that we compute the flux density in a coil of wire 0.1 m long, having 15 turns, that carries a current of 1.0 A, and that is situated in a vacuum. Utilizing Equations (20.1) and (20.3), and solving for  $\mathbf{B}_0$  yields

$$\begin{aligned} B_0 &= \mu_0 H = \frac{\mu_0 NI}{l} \\ &= \frac{(1.257 \times 10^{-6} \text{ H/m})(15 \text{ turns})(1.0 \text{ A})}{0.1 \text{ m}} = 1.89 \times 10^{-4} \text{ tesla} \end{aligned}$$

(b) Now we are to compute the flux density with a bar of the iron-silicon alloy, the  $\mathbf{B}$ - $\mathbf{H}$  behavior for which is shown in Figure 20.24. It is necessary to determine the value of  $\mathbf{H}$  using Equation (20.1) as

$$H = \frac{NI}{l} = \frac{(15 \text{ turns})(1.0 \text{ A})}{0.1 \text{ m}} = 150 \text{ A-turns/m}$$

Using the curve in Figure 20.24,  $\mathbf{B} = 1.65$  tesla at  $\mathbf{H} = 150$  A-turns/m.

(c) Finally, we are to assume that a bar of Mo is situated within the coil, and to calculate the current that is necessary to produce the same  $\mathbf{B}$  field as when the iron-silicon alloy in part (b) was used. Molybdenum is a paramagnetic material having a  $\chi_m$  of  $1.19 \times 10^{-4}$  (Table 20.2). Combining Equations (20.2), (20.4), and (20.7) we get

$$H = \frac{B}{\mu} = \frac{B}{\mu_0 (1 + \chi_m)}$$

And when Mo is positioned within the coil, then

$$H = \frac{1.65 \text{ tesla}}{(1.257 \times 10^{-6} \text{ H/m})(1 + 1.19 \times 10^{-4})} = 1.312 \times 10^6 \text{ A-turns/m}$$

Now, the current may be determined using Equation (20.1);

$$I = \frac{Hl}{N} = \frac{(1.312 \times 10^6 \text{ A-turns/m})(0.1 \text{ m})}{15 \text{ turns}} = 8750 \text{ A}$$

20.3 This problem asks us to show that  $\chi_m$  and  $\mu_r$  are related according to  $\chi_m = \mu_r - 1$ . We begin with Equation (20.5) and substitute for  $\mathbf{M}$  using Equation (20.6). Thus,

$$\mathbf{B} = \mu_0 \mathbf{H} + \mu_0 \mathbf{M} = \mu_0 \mathbf{H} + \mu_0 \chi_m \mathbf{H}$$

But  $\mathbf{B}$  is also defined in Equation (20.2) as

$$\mathbf{B} = \mu \mathbf{H} = \mu_0 \mathbf{H} + \mu_0 \chi_m \mathbf{H}$$

which leads to

$$\mu = \mu_0 (1 + \chi_m)$$

If we divide both sides of this expression by  $\mu_0$

$$\frac{\mu}{\mu_0} = \mu_r = 1 + \chi_m$$

or, upon rearrangement

$$\chi_m = \mu_r - 1$$

20.4 For this problem, we want to convert the volume susceptibility of silver (i.e.,  $-2.38 \times 10^{-5}$ ) into other systems of units.

For the mass susceptibility

$$\begin{aligned} \chi_m(\text{kg}) &= \frac{\chi_m}{\rho(\text{kg}/\text{m}^3)} \\ &= \frac{-2.38 \times 10^{-5}}{10.49 \times 10^3 \text{ kg}/\text{m}^3} = -2.27 \times 10^{-9} \end{aligned}$$

For the atomic susceptibility

$$\begin{aligned} \chi_m(\text{a}) &= \chi_m(\text{kg}) \times [\text{atomic weight (in kg)}] \\ &= (-2.27 \times 10^{-9})(0.10787 \text{ kg/mol}) = -2.45 \times 10^{-10} \end{aligned}$$

For the cgs-emu susceptibilities,

$$\chi'_m = \frac{\chi_m}{4\pi} = \frac{-2.38 \times 10^{-5}}{4\pi} = -1.89 \times 10^{-6}$$

$$\chi'_m(\text{g}) = \frac{\chi'_m}{\rho(\text{g/cm}^3)} = \frac{-1.89 \times 10^{-6}}{10.49 \text{ g/cm}^3} = -1.80 \times 10^{-7}$$

$$\begin{aligned} \chi'_m(\text{a}) &= \chi'_m(\text{g}) \times [\text{atomic weight (in g)}] \\ &= (-1.80 \times 10^{-7})(107.87 \text{ g/mol}) = -1.94 \times 10^{-5} \end{aligned}$$

20.5 (a) The two sources of magnetic moments for electrons are the electron's orbital motion around the nucleus, and also, its spin.

(b) All electrons have a net magnetic moment, which arises from orbital and spin contributions.

(c) All atoms do not have a net magnetic moment. If an atom has completely filled electron shells or subshells, there will be a cancellation of both orbital and spin magnetic moments.

20.6 (a) The magnetic permeability of this material may be determined according to Equation (20.2) as

$$\mu = \frac{B}{H} = \frac{0.630 \text{ tesla}}{5 \times 10^5 \text{ A/m}} = 1.26 \times 10^{-6} \text{ H/m}$$

(b) The magnetic susceptibility is calculated as

$$\begin{aligned} \chi_m &= \frac{\mu}{\mu_0} - 1 = \frac{1.26 \times 10^{-6} \text{ H/m}}{1.257 \times 10^{-6} \text{ H/m}} - 1 \\ &= 2.39 \times 10^{-3} \end{aligned}$$

(c) This material would display both diamagnetic and paramagnetic behavior. All materials are diamagnetic, and since  $\chi_m$  is positive and on the order of  $10^{-3}$ , there would also be a paramagnetic contribution.

20.7 (a) This portion of the problem calls for us to compute the magnetic susceptibility within a bar of some metal alloy when  $\mathbf{M} = 1.2 \times 10^6 \text{ A/m}$  and  $\mathbf{H} = 200 \text{ A/m}$ . This requires that we solve for  $\chi_m$  from Equation (20.6) as

$$\chi_m = \frac{M}{H} = \frac{1.2 \times 10^6 \text{ A/m}}{200 \text{ A/m}} = 6000$$

(b) In order to calculate the permeability we must employ Equations (20.4) and (20.7) as follows:

$$\begin{aligned} \mu &= \mu_r \mu_0 = \mu_0 (\chi_m + 1) \\ &= (1.257 \times 10^{-6} \text{ H/m})(6000 + 1) = 7.54 \times 10^{-3} \text{ H/m} \end{aligned}$$

(c) The magnetic flux density may be determined using Equation (20.2) as

$$B = \mu H = (7.54 \times 10^{-3} \text{ H/m})(200 \text{ A/m}) = 1.51 \text{ tesla}$$

(d) This metal alloy would exhibit ferromagnetic behavior on the basis of the value of its  $\chi_m$  (6000), which is considerably larger than the  $\chi_m$  values for diamagnetic and paramagnetic materials listed in Table 20.2.

20.8 (a) The saturation magnetization for Co may be determined in the same manner as was done for Ni in Example Problem 20.1. Thus,

$$M_s = 1.72 \mu_B N$$

in which  $\mu_B$  is the Bohr magneton and  $N$  is the number of Co atoms per cubic meter. Also, there are 1.72 Bohr magnetons per Co atom. Now,  $N$  (the number of atoms per cubic meter) is related to the density and atomic weight of Co, and Avogadro's number according to Equation (4.2) as

$$\begin{aligned} N &= \frac{\rho_{\text{Co}} N_A}{A_{\text{Co}}} \\ &= \frac{(8.90 \text{ g/cm}^3)(10^2 \text{ cm/m})^3 (6.023 \times 10^{23} \text{ atoms/mol})}{58.93 \text{ g/mol}} \\ &= 9.10 \times 10^{28} \text{ atoms/m}^3 \end{aligned}$$

Therefore,

$$M_s = (1.72 \text{ BM/atom}) \left( 9.27 \times 10^{-24} \text{ A} \cdot \text{m}^2/\text{BM} \right) \left( 9.10 \times 10^{28} \text{ atoms/m}^3 \right)$$

$$= 1.45 \times 10^6 \text{ A/m}$$

(b) The saturation flux density is determined according to Equation (20.8). Thus

$$B_s = \mu_0 M_s$$

$$= \left( 1.257 \times 10^{-6} \text{ H/m} \right) \left( 1.45 \times 10^6 \text{ A/m} \right) = 1.82 \text{ tesla}$$

20.9 We want to confirm that there are 2.2 Bohr magnetons associated with each iron atom. Therefore, let  $n_B$  be the number of Bohr magnetons per atom, which we will calculate. Using a modified form of the expression for  $M_s$  found in Example Problem 20.1

$$n_B = \frac{M_s}{\mu_B N}$$

Now,  $N$  is just the number of atoms per cubic meter, which is the number of atoms per unit cell (two for BCC) divided by the unit cell volume--that is,

$$N = \frac{2}{V_C} = \frac{2}{a^3}$$

$a$  being the BCC unit cell edge length (i.e., 0.2866 nm). Thus

$$n_B = \frac{M_s}{\mu_B N} = \frac{M_s a^3}{2\mu_B}$$

$$= \frac{\left( 1.70 \times 10^6 \text{ A/m} \right) \left[ \left( 0.2866 \times 10^{-9} \text{ m} \right)^3 / \text{unit cell} \right]}{\left( 2 \text{ atoms/unit cell} \right) \left( 9.27 \times 10^{-24} \text{ A} \cdot \text{m}^2/\text{BM} \right)}$$

$$= 2.16 \text{ BM/atom}$$

20.10 We are to determine the number of Bohr magnetons per atom of a hypothetical metal that has a simple cubic crystal structure, an atomic radius of 0.125 nm, and a saturation flux density of 0.85 tesla. It becomes necessary to employ Equations (20.8) and (20.11) as follows:

$$M_s = \frac{B_s}{\mu_o} = \frac{n_B \mu_B}{V_C}$$

For the simple cubic crystal structure  $V_C = (2r)^3$ , where  $r$  is the atomic radius. Substituting this relationship into the above equation and solving for  $n_B$  yields

$$n_B = \frac{B_s (8r^3)}{\mu_o \mu_B}$$

$$= \frac{(0.85 \text{ tesla})(8)(0.125 \times 10^{-9} \text{ m})^3}{(1.257 \times 10^{-6} \text{ H/m})(9.27 \times 10^{-24} \text{ A} \cdot \text{m}^2 / \text{BM})} = 1.14 \text{ Bohr magnetons/atom}$$

20.11 Ferromagnetic materials may be permanently magnetized (whereas paramagnetic ones may not) because of the ability of net spin magnetic moments of adjacent atoms to align with one another. This mutual magnetic moment alignment in the same direction exists within small volume regions--domains. When a magnetic field is applied, favorably oriented domains grow at the expense of unfavorably oriented ones, by the motion of domain walls. When the magnetic field is removed, there remains a net magnetization by virtue of the resistance to movement of domain walls; even after total removal of the magnetic field, the magnetization of some net domain volume will be aligned near the direction that the external field was oriented.

For paramagnetic materials, there is no magnetic dipole coupling, and, consequently, domains do not form. When a magnetic field is removed, the atomic dipoles assume random orientations, and no magnetic moment remains.

20.12 The similarities between ferromagnetic and ferrimagnetic materials are as follows:

There is a coupling interaction between magnetic moments of adjacent atoms/cations for both material types.

Both ferromagnets and ferrimagnets form domains.

Hysteresis **B-H** behavior is displayed by both, and, thus, permanent magnetizations are possible.



The differences between ferromagnetic and ferrimagnetic materials are as follows:

Magnetic moment coupling is parallel for ferromagnetic materials, and antiparallel for ferrimagnetic.

Ferromagnetics, being metallic materials, are relatively good electrical conductors; inasmuch as ferrimagnetic materials are ceramics, they are electrically insulative.

Saturation magnetizations are higher for ferromagnetic materials.

20.13 Both spinel and inverse spinel crystal structures consist of FCC close-packed stackings of anions ( $O^{2-}$  ions). Two types of sites, tetrahedral and octahedral, exist among the anions which may be occupied by the cations. The divalent cations (e.g.,  $Fe^{2+}$ ) occupy tetrahedral positions for both structures. The difference lies in the occupancy for the trivalent cations (e.g.,  $Fe^{3+}$ ). For spinel, all trivalent ions reside on octahedral sites; whereas, for the inverse spinel, half are positioned on tetrahedral sites, the other half on octahedral.

20.14 Hund's rule states that the spins of the electrons of a shell will add together in such a way as to yield the maximum magnetic moment. This means that as electrons fill a shell, the spins of the electrons that fill the first half of the shell are all oriented in the same direction; furthermore, the spins of the electrons that fill the last half of this same shell will all be aligned and oriented in the opposite direction. For example, consider the iron ions in Table 20.4; from Table 2.2, the electron configuration for the outermost shells for the Fe atom is  $3d^6 4s^2$ . For the  $Fe^{3+}$  ion the outermost shell configuration is  $3d^5$ , which means that five of the ten possible 3d states are filled with electrons. According to Hund's rule the spins of all of these electrons are aligned, there will be no cancellation, and therefore, there are five Bohr magnetons associated with each  $Fe^{3+}$  ion, as noted in the table. For  $Fe^{2+}$  the configuration of the outermost shell is  $3d^6$ , which means that the spins of five electrons are aligned in one direction, and the spin of a single electron is aligned in the opposite direction, which cancels the magnetic moment of one of the other five; thus, this yields a net moment of four Bohr magnetons.

For  $Mn^{2+}$  the electron configuration is  $3d^5$ , the same as  $Fe^{3+}$ , and, therefore it will have the same number of Bohr magnetons (i.e., five).

For  $Co^{2+}$  the electron configuration is  $3d^7$ , which means that the spins of five electrons are in one direction, and two are in the opposite direction, which gives rise to a net moment of three Bohr magnetons.

For  $Ni^{2+}$  the electron configuration is  $3d^8$  which means that the spins of five electrons are in one direction, and three are in the opposite direction, which gives rise to a net moment of two Bohr magnetons.

For  $\text{Cu}^{2+}$  the electron configuration is  $3d^9$  which means that the spins of five electrons are in one direction, and four are in the opposite direction, which gives rise to a net moment of one Bohr magneton.

20.15 (a) The saturation magnetization of nickel ferrite is computed in the same manner as Example Problem 20.2, and from the expression

$$M_s = \frac{n_B \mu_B}{a^3}$$

Now,  $n_B$  is just the number of Bohr magnetons per unit cell. The net magnetic moment arises from the  $\text{Ni}^{2+}$  ions, of which there are eight per unit cell, each of which has a net magnetic moment of two Bohr magnetons (Table 20.4). Thus,  $n_B$  is sixteen. Therefore,

$$\begin{aligned} M_s &= \frac{(16 \text{ BM/unit cell})(9.27 \times 10^{-24} \text{ A} \cdot \text{m}^2/\text{BM})}{(0.8337 \times 10^{-9} \text{ m})^3/\text{unit cell}} \\ &= 2.56 \times 10^5 \text{ A/m} \end{aligned}$$

(b) This portion of the problem calls for us to compute the saturation flux density. From Equation (20.8)

$$\begin{aligned} B_s &= \mu_0 M_s \\ &= (1.257 \times 10^{-6} \text{ H/m})(2.56 \times 10^5 \text{ A/m}) = 0.32 \text{ tesla} \end{aligned}$$

20.16 We want to compute the number of Bohr magnetons per  $\text{Mn}^{2+}$  ion in  $(\text{MnFe}_2\text{O}_4)_8$ . Let  $n$  represent the number of Bohr magnetons per  $\text{Mn}^{2+}$  ion; then, using the expression given in Example Problem 20.1, we have

$$M_s = nN\mu_B$$

in which  $N$  is the number of  $\text{Mn}^{2+}$  ions per cubic meter of material. But, from Equation (4.2)

$$N = \frac{N_A \rho}{A}$$

in which **A** is the molecular weight of  $\text{MnFe}_2\text{O}_4$  (230.64 g/mol). Thus,

$$M_s = \frac{n N_A \rho \mu_B}{A}$$

or

$$n = \frac{M_s A}{N_A \rho \mu_B}$$

$$= \frac{(5.6 \times 10^5 \text{ A/m}) (230.64 \text{ g/mol})}{(6.023 \times 10^{23} \text{ ions/mol}) (5.0 \text{ g/m}^3) (10^2 \text{ cm/m})^3 (9.27 \times 10^{-24} \text{ A} \cdot \text{m}^2 / \text{BM})}$$

$$= 4.6 \text{ Bohr magnetons/Mn}^{2+} \text{ ion}$$

20.17 For this problem we are given that yttrium iron garnet may be written in the form  $\text{Y}_3^c\text{Fe}_2^a\text{Fe}_3^d\text{O}_{12}$  in which the superscripts **a**, **c**, and **d** represent different sites on which the  $\text{Y}^{3+}$  and  $\text{Fe}^{3+}$  ions are located, and that the spin magnetic moments for the ions on **a** and **c** sites are oriented parallel to one another and antiparallel to the  $\text{Fe}^{3+}$  ions on the **d** sites. We are to determine the number of Bohr magnetons associated with each  $\text{Y}^{3+}$  ion given that each unit cell consists of eight formula units, the unit cell is cubic with an edge length of 1.2376 nm, the saturation magnetization for the material is  $1.0 \times 10^4 \text{ A/m}$ , and that there are 5 Bohr magnetons for each  $\text{Fe}^{3+}$  ion.

The first thing to do is to calculate the number of Bohr magnetons per unit cell, which we will denote  $n_B$ . Solving for  $n_B$  using Equation (20.11), we get

$$n_B = \frac{M_s V_C}{\mu_B} = \frac{M_s a^3}{\mu_B}$$

$$= \frac{(1.0 \times 10^4 \text{ A/m}) (1.2376 \times 10^{-9} \text{ m})^3}{9.27 \times 10^{-24} \text{ A} \cdot \text{m}^2 / \text{BM}} = 2.04 \text{ Bohr magnetons/unit cell}$$

Now, there are 8 formula units per unit cell or  $\frac{2.04}{8} = 0.255$  Bohr magnetons per formula unit.

Furthermore, for each formula unit there are two  $\text{Fe}^{3+}$  ions on **a** sites and three  $\text{Fe}^{3+}$  on **d** sites which magnetic moments are aligned antiparallel. Since there are 5 Bohr magnetons associated with

each  $\text{Fe}^{3+}$  ion, the net magnetic moment contribution per formula unit from the  $\text{Fe}^{3+}$  ions is 5 Bohr magnetons. This contribution is antiparallel to the contribution from the  $\text{Y}^{3+}$  ions, and since there are three  $\text{Y}^{3+}$  ions per formula unit

$$\text{No. of Bohr magnetons}/\text{Y}^{3+} = \frac{0.255 \text{ BM} + 5 \text{ BM}}{3} = 1.75 \text{ BM}$$

20.18 Repeatedly dropping a permanent magnet on the floor will cause it to become demagnetized because the jarring will cause large numbers of magnetic dipoles to become misaligned by dipole rotation.

20.19 For ferromagnetic materials, the saturation magnetization decreases with increasing temperature because the atomic thermal vibrational motions counteract the coupling forces between the adjacent atomic dipole moments, causing some magnetic dipole misalignment. Ferromagnetic behavior ceases above the Curie temperature because the atomic thermal vibrations are sufficiently violent so as to completely destroy the mutual spin coupling forces.

20.20 The phenomenon of magnetic hysteresis and an explanation as to why it occurs for ferromagnetic and ferrimagnetic materials is given in Section 20.7.

20.21 The  $\mathbf{B}$  versus  $\mathbf{H}$  behaviors for a ferromagnetic material at 0 K, at a temperature just below its Curie temperature, and just above its Curie temperature are sketched schematically below.

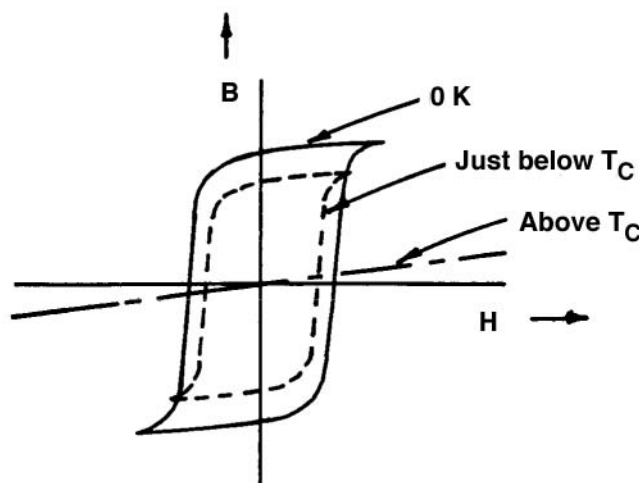

At 0 K, the saturation magnetization will be a maximum, and the hysteresis loop will have the largest area. At a higher temperature (yet below the Curie temperature) the saturation magnetization will decrease and the size of the hysteresis loop will diminish. Finally, above the Curie temperature, ferromagnetic behavior ceases, and the material becomes paramagnetic, with linear **B** versus **H** behavior; the slope of this line segment is very gentle.

20.22 A schematic sketch showing the hysteresis behavior for a ferromagnet that is gradually demagnetized by cycling an **H** field that alternates direction and decreases in magnitude is shown below.

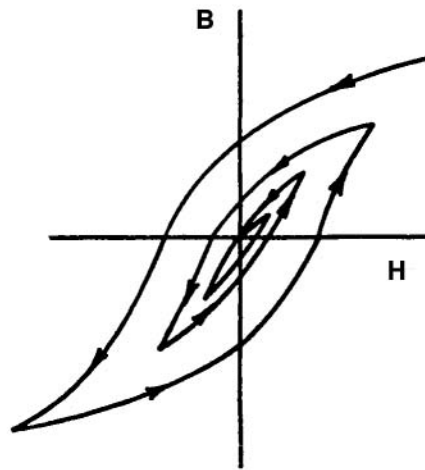

20.23 Relative to hysteresis behavior, a hard magnetic material has a high remanence, a high coercivity, a high saturation flux density, high hysteresis energy losses, and a low initial permeability; a soft magnetic material, on the other hand, has a high initial permeability, a low coercivity, and low hysteresis energy losses.

With regard to applications, hard magnetic materials are utilized for permanent magnets; soft magnetic materials are used in devices that are subjected to alternating magnetic fields such as transformer cores, generators, motors, and magnetic amplifier devices.

20.24 We want to determine the saturation magnetization of the 99.95 wt% Fe in Table 20.5, if it just reaches saturation when inserted within the coil described in Problem 20.1. It is first necessary to compute the **H** field within this coil using Equation (20.1) as

$$H_s = \frac{NI}{l} = \frac{(200 \text{ turns})(10 \text{ A})}{0.2 \text{ m}} = 10^4 \text{ A-turns/m}$$

Now, the saturation magnetization may be determined from Equation (20.5) as

$$M_s = \frac{B_s - \mu_0 H_s}{\mu_0}$$

The value of  $B_s$  in Table 20.5 is 2.14 tesla; thus,

$$\begin{aligned} M_s &= \frac{(2.14 \text{ tesla}) - (1.257 \times 10^{-6} \text{ H/m})(10^4 \text{ A/m})}{1.257 \times 10^{-6} \text{ H/m}} \\ &= 1.69 \times 10^6 \text{ A/m} \end{aligned}$$

20.25 (a) The saturation flux density for the steel, the  $\mathbf{B-H}$  behavior for which is shown in Figure 20.25, is 1.30 tesla, the maximum  $\mathbf{B}$  value shown on the plot.

(b) The saturation magnetization is computed from Equation (20.8) as

$$\begin{aligned} M_s &= \frac{B_s}{\mu_0} \\ &= \frac{1.30 \text{ tesla}}{1.257 \times 10^{-6} \text{ H/m}} = 1.03 \times 10^6 \text{ A/m} \end{aligned}$$

(c) The remanence,  $\mathbf{B}_r$ , is read from this plot (Figure 20.25) in the same manner as from the hysteresis loop shown in Figure 20.14; its value is 0.80 tesla.

(d) The coercivity,  $\mathbf{H}_c$ , is read from this plot in the same fashion as from Figure 20.14; the value is 80 A/m.

(e) On the basis of Tables 20.5 and 20.6, this is most likely a soft magnetic material. The saturation flux density (1.30 tesla) lies within the range of values cited for soft materials, and the remanence (0.80 tesla) is close to the values given in Table 20.6 for hard magnetic materials. However, the  $\mathbf{H}_c$  is significantly lower than for hard magnetic materials. Also, if we estimate the area within the hysteresis curve, we get a value of approximately  $250 \text{ J/m}^3$ , which is in line with the hysteresis loss per cycle for soft magnetic materials.

20.26 The  $\mathbf{B}$  versus  $\mathbf{H}$  curve for this material is shown below.

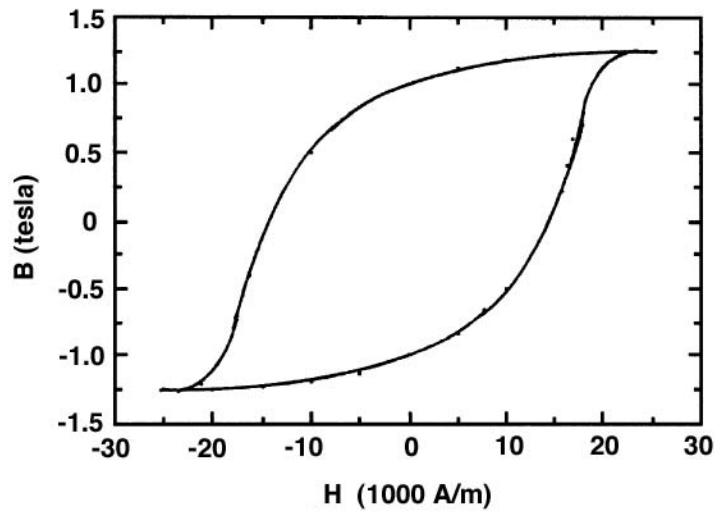

20.27 (a) The **B-H** data provided in the problem are plotted below.

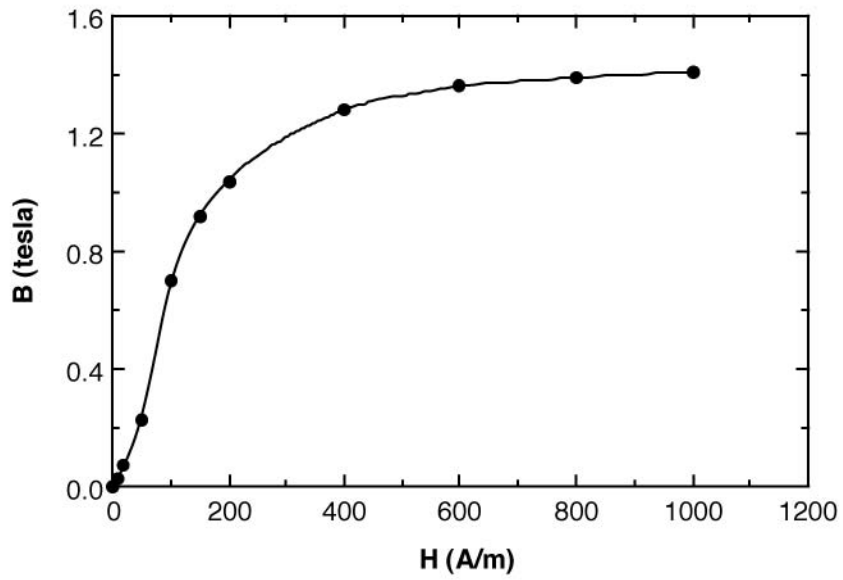

(b) The first four data points are plotted below.

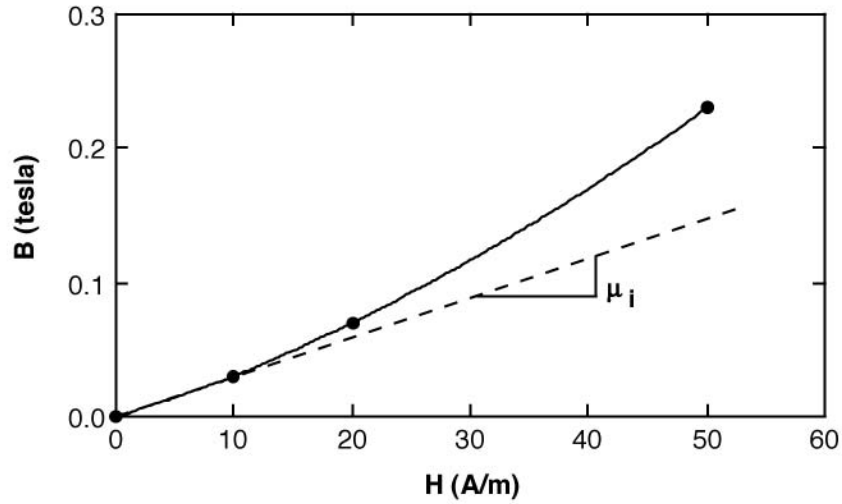

The slope of the initial portion of the curve is  $\mu_i$  (as shown), is

$$\mu_i = \frac{\Delta B}{\Delta H} = \frac{(0.15 - 0) \text{ tesla}}{(50 - 0) \text{ A/m}} = 3.0 \times 10^{-3} \text{ H/m}$$

Also, the initial relative permeability [Equation (20.4)] is just

$$\mu_{ri} = \frac{\mu_i}{\mu_o} = \frac{3.0 \times 10^{-3} \text{ H/m}}{1.257 \times 10^{-6} \text{ H/m}} = 2400$$

(c) The maximum permeability is the tangent to the **B-H** curve having the greatest slope; it is drawn on the plot below, and designated as  $\mu(\text{max})$ .

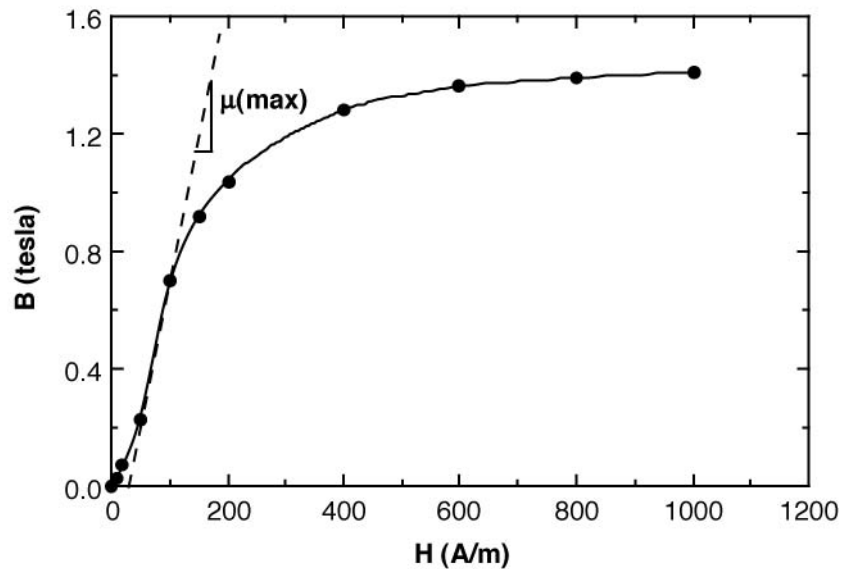



The value of  $\mu(\text{max})$  is

$$\mu(\text{max}) = \frac{\Delta B}{\Delta H} = \frac{(1.3 - 0.3) \text{ tesla}}{(160 - 45) \text{ A}\cdot\text{m}} = 8.70 \times 10^{-3} \text{ H/m}$$

(d) The  $\mathbf{H}$  field at which  $\mu(\text{max})$  occurs is approximately 80 A/m [as taken from the plot shown in part (c)].

(e) We are asked for the maximum susceptibility,  $\chi(\text{max})$ . From Equation (20.7)

$$\begin{aligned} \chi(\text{max}) &= \mu_r(\text{max}) - 1 = \frac{\mu(\text{max})}{\mu_0} - 1 \\ &= \frac{8.70 \times 10^{-3} \text{ H/m}}{1.257 \times 10^{-6} \text{ H/m}} - 1 = 6920 \end{aligned}$$

20.28 In order to demagnetize a magnet having a coercivity of 4000 A/m, an  $\mathbf{H}$  field of 4000 A/m must be applied in a direction opposite to that of magnetization. According to Equation (20.1)

$$\begin{aligned} I &= \frac{Hl}{N} \\ &= \frac{(4000 \text{ A/m})(0.15 \text{ m})}{100 \text{ turns}} = 6.0 \text{ A} \end{aligned}$$

20.29 (a) We want to determine the magnitude of the  $\mathbf{B}$  field within an iron-silicon alloy, the  $\mathbf{B}$ - $\mathbf{H}$  behavior for which is shown in Figure 20.24, when  $l = 0.20 \text{ m}$ ,  $N = 60$  turns, and  $I = 0.1 \text{ A}$ . Applying Equation (20.1)

$$H = \frac{NI}{l} = \frac{(60 \text{ turns})(0.1 \text{ A})}{0.20 \text{ m}} = 30 \text{ A/m}$$

The  $\mathbf{B}$  value from the curve corresponding to  $\mathbf{H} = 30 \text{ A/m}$  is about 1.35 tesla.

(b)

(i) The permeability at this field is just  $\Delta\mathbf{B}/\Delta\mathbf{H}$  of the tangent of the  $\mathbf{B}$ - $\mathbf{H}$  curve at  $\mathbf{H} = 30 \text{ A/m}$ .

The slope of this line is

$$\mu = \frac{\Delta B}{\Delta H} = \frac{(1.6 - 1.07) \text{ tesla}}{(52 - 0) \text{ A/m}} = 1.0 \times 10^{-2} \text{ H/m}$$

(ii) From Equation (20.4), the relative permeability is

$$\mu_r = \frac{\mu}{\mu_o} = \frac{1.0 \times 10^{-2} \text{ H/m}}{1.257 \times 10^{-6} \text{ H/m}} = 7955$$

(iii) Using Equation (20.7), the susceptibility is

$$\chi_m = \mu_r - 1 = 7955 - 1 = 7954$$

(iv) The magnetization is determined from Equation (20.6) as

$$M = \chi_m H = (7954)(30 \text{ A/m}) = 2.4 \times 10^5 \text{ A/m}$$

20.30 Hindering domain boundary movement will enhance the coercivity of the magnetic material, without producing a significant alteration of the saturation flux density. Thus, schematic **B-H** behaviors with and without domain boundary obstruction are shown below.

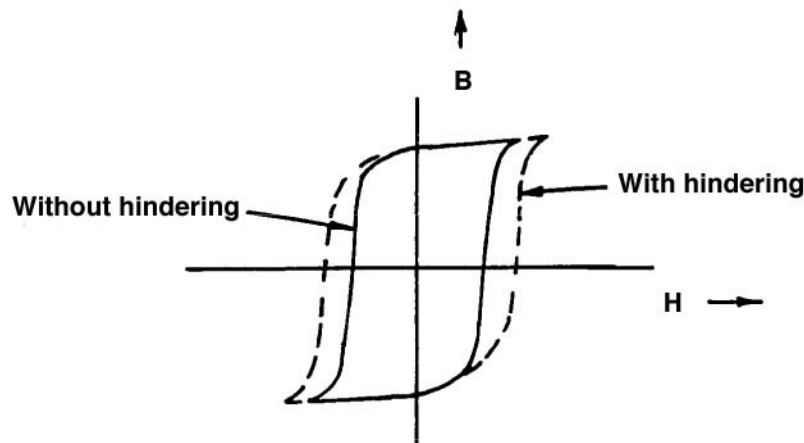

20.31 The manner in which information is stored magnetically is discussed in Section 20.10.

20.32 (a) Given Equation (20.12) and the data in Table 20.7, we are asked to calculate the critical magnetic fields for lead at 2.5 and 5.0 K. From the table, for Pb,  $T_C = 7.19 \text{ K}$  and  $B_C(0) = 0.0803$  tesla. Thus, from Equation (20.3)

$$H_C(0) = \frac{B_C(0)}{\mu_o}$$

$$= \frac{0.0803 \text{ tesla}}{1.257 \times 10^{-6} \text{ H/m}} = 6.39 \times 10^4 \text{ A/m}$$

Now, solving for  $H_C(2.5)$  and  $H_C(5.0)$  using Equation (20.12) yields

$$H_C(T) = H_C(0) \left[ 1 - \frac{T^2}{T_C^2} \right]$$

$$H_C(2.5) = \left( 6.39 \times 10^4 \text{ A/m} \right) \left[ 1 - \frac{(2.5 \text{ K})^2}{(7.19 \text{ K})^2} \right] = 5.62 \times 10^4 \text{ A/m}$$

$$H_C(5.0) = \left( 6.39 \times 10^4 \text{ A/m} \right) \left[ 1 - \frac{(5.0 \text{ K})^2}{(7.19 \text{ K})^2} \right] = 3.30 \times 10^4 \text{ A/m}$$

(b) Now we are to determine the temperature to which mercury must be cooled in a magnetic field of 15,000 A/m in order for it to be superconductive. The value of  $H_C(0)$  must first be determined using  $B_C(0)$  given in the table (i.e., 0.0411 tesla); thus from Equation (20.3)

$$H_C(0) = \frac{B_C(0)}{\mu_0} = \frac{0.0411 \text{ tesla}}{1.257 \times 10^{-6} \text{ H/m}} = 3.27 \times 10^4 \text{ A/m}$$

Since  $T_C = 4.15 \text{ K}$  we may solve for  $T$  using Equation (20.12) as

$$\begin{aligned} T &= T_C \sqrt{1 - \frac{H_C(T)}{H_C(0)}} \\ &= (4.15 \text{ K}) \sqrt{1 - \frac{15,000 \text{ A/m}}{32,700 \text{ A/m}}} = 3.05 \text{ K} \end{aligned}$$

20.33 We are asked to determine which of the superconducting elements in Table 20.7 are superconducting at 2 K and in a magnetic field of 40,000 A/m. First of all, in order to be superconductive at 2 K within any magnetic field, the critical temperature must be greater than 2 K. Thus, aluminum, titanium, and tungsten may be eliminated upon inspection. Now, for each of lead, mercury, and tin it is necessary, using Equation (20.12), to compute the value of  $H_C(2)$ ; if this value is greater than 40,000 A/m then the element will be superconductive. Hence, for Pb

$$H_C(2) = \frac{B_C(0)}{\mu_o} \left[ 1 - \frac{T^2}{T_C^2} \right]$$

$$= \frac{0.0803 \text{ tesla}}{1.257 \times 10^{-6} \text{ H/m}} \left[ 1 - \frac{(2.0 \text{ K})^2}{(7.19 \text{ K})^2} \right] = 5.89 \times 10^4 \text{ A/m}$$

Since this value is greater than 40,000 A/m, Pb will be superconductive.

For Hg

$$H_C(2) = \frac{0.0411 \text{ tesla}}{1.257 \times 10^{-6} \text{ H/m}} \left[ 1 - \frac{(2.0 \text{ K})^2}{(4.15 \text{ K})^2} \right] = 2.51 \times 10^4 \text{ A/m}$$

Inasmuch as this value is less than 40,000 A/m, Hg will not be superconductive.

As for Sn

$$H_C(2) = \frac{0.0305 \text{ tesla}}{1.257 \times 10^{-6} \text{ H/m}} \left[ 1 - \frac{(2.0 \text{ K})^2}{(3.72 \text{ K})^2} \right] = 1.73 \times 10^3 \text{ A/m}$$

Therefore, Sn is not superconductive.

20.34 With increasing magnetic field, type I superconductors are completely diamagnetic and superconductive below  $H_C$ , while at  $H_C$  conduction becomes normal and complete magnetic flux penetration takes place. On the other hand, for type II superconductors upon increasing the magnitude of the magnetic field, the transition from the superconducting to normal conducting states is gradual between lower-critical and upper-critical fields; so also is magnetic flux penetration gradual. Furthermore, type II generally have higher critical temperatures and critical magnetic fields.

20.35 The Meissner effect is a phenomenon found in superconductors wherein, in the superconducting state, the material is diamagnetic and completely excludes any external magnetic field from its interior. In the normal conducting state complete magnetic flux penetration of the material occurs.

20.36 The primary limitation of the new superconducting materials that have relatively high critical temperatures is that, being ceramics, they are inherently brittle and difficult to form into useful shapes.

### Design Problems

20.D1 For this problem we are asked to determine the composition of a Co-Ni alloy that will yield a saturation magnetization of  $1.3 \times 10^6$  A/m. To begin, let us compute the number of Bohr magnetons per unit cell  $n_B$  from an expression that results from combining Equations (20.9) and (20.10). That is

$$n_B = \frac{M_S V_C}{\mu_B}$$

in which  $M_S$  is the saturation magnetization,  $V_C$  is the unit cell volume, and  $\mu_B$  is the magnitude of the Bohr magneton. In Problem 3.7 it was shown for the HCP crystal structure that

$$V_C = \left(\frac{c}{a}\right)(12\sqrt{3})R^3$$

where  $R$  is the atomic radius. From the inside of the front cover, the value of  $R$  for Co is given as 0.125 nm ( $1.25 \times 10^{-10}$  m). Therefore, inasmuch as the  $c/a$  ratio for Co is 1.623, then

$$\begin{aligned} V_C &= (1.623)(12\sqrt{3})(1.25 \times 10^{-10} \text{ m})^3 \\ &= 6.59 \times 10^{-29} \text{ m}^3 \end{aligned}$$

And, now solving for  $n_B$  yields

$$\begin{aligned} n_B &= \frac{(1.3 \times 10^6 \text{ A/m})(6.59 \times 10^{-29} \text{ m}^3/\text{unit cell})}{\frac{9.27 \times 10^{-24} \text{ A} \cdot \text{m}^2}{\text{Bohr magneton}}} \\ &= \frac{9.24 \text{ Bohr magneton}}{\text{unit cell}} \end{aligned}$$

Inasmuch as there are 1.72 and 0.60 Bohr magnetons for each of Co and Ni, and, for HCP, there are 6 equivalent atoms per unit cell, and if we represent the fraction of Ni atoms by  $x$ , then

$$n_B = 9.24 \text{ Bohr magnetons/unit cell}$$

$$= \left( \frac{0.6 \text{ Bohr magnetons}}{\text{Ni atom}} \right) \left( \frac{6x \text{ Ni atoms}}{\text{unit cell}} \right) + \left( \frac{1.72 \text{ Bohr magnetons}}{\text{Co atom}} \right) \left[ \frac{(6)(1-x) \text{ Co atoms}}{\text{unit cell}} \right]$$

And solving for  $x$ , the fraction of Ni atoms,  $x = 0.161$ , of 16.1 at% Ni.

In order to convert this composition to weight percent, we employ Equation (4.7) as

$$C_{Ni} = \frac{C'_{Ni} A_{Ni}}{C'_{Ni} A_{Ni} + C'_{Co} A_{Co}} \times 100$$

$$= \frac{(16.1 \text{ at%})(58.69 \text{ g/mol})}{(16.1 \text{ at%})(58.69 \text{ g/mol}) + (83.9 \text{ at%})(58.93 \text{ g/mol})} \times 100$$

$$= 16.0 \text{ wt\%}$$

20.D2 This problem asks that we design a cubic mixed-ferrite magnetic material that has a saturation magnetization of  $4.25 \times 10^5 \text{ A/m}$ . According to Example Problem 20.2 the saturation magnetization for  $\text{Fe}_3\text{O}_4$  is  $5.0 \times 10^5 \text{ A/m}$ . In order to decrease the magnitude of  $\mathbf{M}_s$  it is necessary to replace some fraction of the  $\text{Fe}^{2+}$  with a divalent metal ion that has a smaller magnetic moment. From Table 20.4 it may be noted that  $\text{Co}^{2+}$ ,  $\text{Ni}^{2+}$ , and  $\text{Cu}^{2+}$ , with 3, 2, and 1 Bohr magnetons per ion, respectively, have fewer than the 4 Bohr magnetons/ $\text{Fe}^{2+}$  ion. Let us first consider  $\text{Ni}^{2+}$  (with 2 Bohr magnetons per ion) and employ Equation (20.11) to compute the number of Bohr magnetons per unit cell ( $n_B$ ), assuming that the  $\text{Ni}^{2+}$  addition does not change the unit cell edge length (0.839 nm, Example Problem 20.2). Thus,

$$n_B = \frac{M_s a^3}{\mu_B}$$

$$= \frac{(4.25 \times 10^5 \text{ A/m})(0.839 \times 10^{-9} \text{ m})^3 / \text{unit cell}}{9.27 \times 10^{-24} \text{ A} \cdot \text{m}^2 / \text{Bohr magneton}}$$

$$= 27.08 \text{ Bohr magnetons/unit cell}$$

If we let  $x$  represent the fraction of  $\text{Ni}^{2+}$  that have substituted for  $\text{Fe}^{2+}$ , then the remaining unsubstituted  $\text{Fe}^{2+}$  fraction is equal to  $1 - x$ . Furthermore, inasmuch as there are 8 divalent ions per unit cell, we may write the following expression:

$$\eta_B = 8[2x + 4(1 - x)] = 27.08$$

which leads to  $x = 0.308$ . Thus, if 30.8 at% of the  $\text{Fe}^{2+}$  in  $\text{Fe}_3\text{O}_4$  are replaced with  $\text{Ni}^{2+}$ , the saturation magnetization will be decreased to  $4.25 \times 10^5$  A/m.

Upon going through this same procedure for Co and Cu, we find that  $x_{\text{Co}} = 0.615$  (or 61.5 at%) and  $x_{\text{Cu}} = 0.205$  (20.5 at%) will yield the  $4.25 \times 10^5$  A/m saturation magnetization.

- 20.D3 (a) The mechanism by which the VCR head records and plays back audio/video signals is essentially the same as the manner by which the head on a computer storage device reads and writes, as described in Section 20.10.
- (b) Heads should be made from soft magnetic materials inasmuch as they are repeatedly magnetized and demagnetized. Some of the requisite properties for these materials are as follows: 1) a relatively high saturation flux density (a  $\mathbf{B}_s$  of at least 0.5 tesla); 2) a relatively high initial permeability (at least 8000); 3) a relatively small hysteresis loop in order to keep energy losses small; 4) a low remanence; 5) a relatively high mechanical hardness in order to resist surface wear (a minimum Vickers hardness of 120); and 6) a moderate electrical resistivity (at least  $0.6 \times 10^{-6} \Omega\text{-m}$ ).
- (c) It is up to the student to supply three appropriate candidate materials having properties consistent with the above requirements.

## CHAPTER 21

### OPTICAL PROPERTIES

#### PROBLEM SOLUTIONS

21.1 Similarities between photons and phonons are:

- 1) Both may be described as being wave-like in nature.
- 2) The energy for both is quantized.

Differences between photons and phonons are:

- 1) Phonons are elastic waves that exist within solid materials. Photons are electromagnetic energy packets that may exist in solid materials, as well as in other media.
- 2) There is a considerable disparity between the velocities of photons and phonons. The velocity of a photon is the same as the velocity of light in the particular medium; for a phonon, its velocity is that of sound.

21.2 From the classical perspective, electromagnetic radiation is wave-like in character, and the possible energies of the radiation are continuous. From the quantum-mechanical perspective, electromagnetic radiation is dual-like in character (being both wave-like and particle-like), and not all energies are possible (i.e., energy is quantized).

21.3 In order to compute the frequency of a photon of orange light, we must use Equation (21.2) as

$$v = \frac{c}{\lambda} = \frac{3 \times 10^8 \text{ m/s}}{6 \times 10^{-7} \text{ m}} = 5 \times 10^{14} \text{ s}^{-1}$$

Now, for the energy computation, we employ Equation (21.3) as follows:

$$E = \frac{hc}{\lambda} = \frac{(6.63 \times 10^{-34} \text{ J}\cdot\text{s})(3 \times 10^8 \text{ m/s})}{6 \times 10^{-7} \text{ m}}$$
$$= 3.31 \times 10^{-19} \text{ J} \quad (2.07 \text{ eV})$$

21.4 Opaque materials are impervious to light transmission; it is not possible to see through them.

Light is transmitted diffusely through translucent materials (there is some internal light scattering). Objects are not clearly distinguishable when viewed through a translucent material.



Virtually all of the incident light is transmitted through transparent materials, and one can see clearly through them.

21.5 (a) The phenomenon of electronic polarization by electromagnetic radiation is described in Section 21.4.

(b) Two consequences of electronic polarization in transparent materials are absorption and refraction.

21.6 (a) In ionic materials, the larger the size of the component ions the greater the degree of electronic polarization.

(b) Upon consultation of Table 12.3 we find that the  $\text{Ba}^{2+}$ ,  $\text{Ca}^{2+}$ ,  $\text{Na}^+$ , and  $\text{K}^+$  ions are all greater in size than the  $\text{Si}^{4+}$  ion (0.136, 0.100, 0.102, and 0.040 nm, respectively, versus 0.040 nm), and, therefore, all of these ions will increase the index of refraction when added to  $\text{SiO}_2$ .

21.7 (a) The electron band structures of metals are such that empty and available electron states are adjacent to filled states. Electron excitations from filled to empty states are possible with the absorption of electromagnetic radiation having frequencies within the visible spectrum, according to Equation (21.6). The light energy is totally absorbed or reflected, and, since none is transmitted, the material is opaque.

(b) Metals are transparent to high-frequency x-ray and  $\gamma$ -ray radiation since the energies of these types of radiation are greater than for visible light; electron excitations corresponding to these energies are not possible because energies for such transitions are to within an energy band gap beyond the highest partially-filled energy band.

21.8 In order for a material to have an index of refraction less than unity, the velocity of light in the material ( $v$ ) would necessarily have to be greater than the velocity of light in a vacuum [Equation (21.7)]. This is not possible.

21.9 We want to compute the velocity of light in diamond given that  $\epsilon_r = 5.5$  and  $\chi_m = -2.17 \times 10^{-5}$ . The velocity is determined using Equation (21.8); but first, we must calculate the values of  $\epsilon$  and  $\mu$  for diamond. According to Equation (18.7W)

$$\epsilon = \epsilon_r \epsilon_0 = (5.5)(8.85 \times 10^{-12} \text{ F/m}) = 4.87 \times 10^{-11} \text{ F/m}$$

Now, combining Equations (20.4) and (20.7)

$$\begin{aligned}\mu &= \mu_o(\chi_m + 1) \\ &= (1.257 \times 10^{-6} \text{ H/m})(1 - 2.17 \times 10^{-5}) = 1.257 \times 10^{-6} \text{ H/m}\end{aligned}$$

And, finally

$$\begin{aligned}v &= \frac{1}{\sqrt{\epsilon\mu}} \\ &= \frac{1}{\sqrt{(4.87 \times 10^{-11} \text{ F/m})(1.257 \times 10^{-6} \text{ H/m})}} \\ &= 1.28 \times 10^8 \text{ m/s}\end{aligned}$$

21.10W The frequencies of visible radiation are on the order of  $10^{15}$  Hz (Figure 21.2). At these frequencies only electronic polarization is operable (Figure 18.8W). Thus,  $\epsilon_r$  from Equation (21.10) is the electronic contribution to  $\epsilon_r$ ; let us designate it as  $\epsilon_r'$ . Or, in other words

$$\epsilon_r' = n^2$$

And using **n** values found in Table 21.1:

For fused silica

$$\epsilon_r'(\text{silica}) = (1.458)^2 = 2.13$$

And, for soda-lime glass

$$\epsilon_r'(\text{glass}) = (1.51)^2 = 2.28$$

The fraction of the electronic contribution is just the ratio of  $\epsilon_r'$  and  $\epsilon_r$ ,  $\epsilon_r$  values being taken from Table 18.1W. Thus

$$\frac{\epsilon_r'(\text{silica})}{\epsilon_r(60 \text{ Hz})} = \frac{2.13}{4.0} = 0.53$$

and

$$\frac{\epsilon_r'(\text{glass})}{\epsilon_r(60 \text{ Hz})} = \frac{2.28}{6.9} = 0.33$$

21.11W This problem asks for us, using data in Table 21.1, to estimate the dielectric constants for silica glass, soda-lime glass, PTFE, polyethylene, and polystyrene, and then to compare these values with those cited in Table 18.1W and briefly explain any discrepancies. From Equation (21.10)

$$\epsilon_r = n^2$$

Thus, for fused silica, since  $n = 1.458$

$$\epsilon_r = (1.458)^2 = 2.13$$

Similarly, for soda-lime glass

$$\epsilon_r = (1.51)^2 = 2.28$$

And, for PTFE

$$\epsilon_r = (1.35)^2 = 1.82$$

For polyethylene

$$\epsilon_r = (1.51)^2 = 2.28$$

For polystyrene

$$\epsilon_r = (1.60)^2 = 2.56$$

When we compare the values of  $\epsilon_r$  for the polymers (i.e., PTFE, PE, and PS) with those in Table 18.1W at frequencies of 1 MHz, there is reasonable agreement (i.e., 1.82 versus 2.1 for PTFE, 2.28 versus 2.3 for polyethylene, and 2.56 versus 2.6 for polystyrene). However, for fused silica and soda-lime glass there are some significant discrepancies (i.e., 2.13 versus 3.8 for the fused silica, and 2.28 versus 6.9 for the soda-lime glass). The reason for these discrepancies is that for these two materials an ionic component to the dielectric constant is present at 1 MHz, but is absent at frequencies within the visible electromagnetic spectrum, which frequencies are on the order  $10^9$  MHz ( $10^{15}$  Hz). These effects may be noted in Figure 18.8W.

21.12 Dispersion in a transparent medium is the phenomenon wherein the index of refraction varies slightly with the wavelength of the electromagnetic radiation.

21.13 For this problem we want to compute the maximum value of  $n_s$  in Equation (21.13) that will give  $R = 0.050$ . Then we are to consult Table 21.1 in order to ascertain which of the materials listed have indices of refraction less than this maximum value. From Equation (21.13)

$$0.050 = \frac{[n_s - 1]^2}{[n_s + 1]^2} = \frac{n_s^2 - 2n_s + 1}{n_s^2 + 2n_s + 1}$$

or

$$0.95 n_s^2 - 2.10 n_s + 0.95 = 0$$

The solution of this quadratic equation is as follows:

$$n_s = \frac{-(-2.10) \pm \sqrt{(-2.10)^2 - (4)(0.95)(0.95)}}{(2)(0.95)}$$

Which leads to the following two roots:

$$n_s(+)= 1.576$$

$$n_s(-)= 0.635$$

Only the  $n_s(+)$  solution (1.576) is physically meaningful. Thus, of the materials listed, soda-lime glass, Pyrex glass, and polypropylene have indices of refraction less than 1.576, and would be suitable for this application.

21.14 The thickness and dielectric constant of a thin surface coating are selected such that there is destructive interference between the light beam that is reflected from the lens-coating interface and the light beam that is reflected from the coating-air interface; thus, the net intensity of the total reflected beam is very low.

21.15 The three absorption mechanisms in nonmetallic materials involve electronic polarization, electron transitions, and scattering. Electronic polarization is described in Section 21.4; absorption by

electron transitions is discussed in Sections 21.4 and 21.7; and scattering is discussed in Section 21.10.

21.16 We want to decide whether or not Si and Ge are transparent to visible light on the basis of their band gap energies. Table 18.2 cites 1.11 and 0.67 eV, respectively, as the  $E_g$ 's for these two semiconductors. According to Equation (21.16b), semiconductors having band gap energies less than about 1.8 eV are opaque to visible light. Thus, both Si and Ge fall into this category, and all visible light is absorbed by valence-band-to-conduction-band-electron transitions across their reasonably narrow band gaps.

21.17 This problem asks us to determine the range of visible light wavelengths over which ZnTe ( $E_g = 2.26$  eV) is transparent. Only photons having energies of 2.26 eV or greater are absorbed by valence-band-to-conduction-band electron transitions. Thus, photons having energies less than 2.26 eV are not absorbed; the minimum photon energy for visible light is 1.8 eV [Equation (21.16b)], which corresponds to a wavelength of 0.7  $\mu\text{m}$ . The wavelength of a photon having an energy of 2.26 eV, using Equation (21.3), is just

$$\lambda = \frac{hc}{E} = \frac{(4.13 \times 10^{-15} \text{ eV}\cdot\text{s})(3 \times 10^8 \text{ m/s})}{2.26 \text{ eV}}$$

$$= 5.5 \times 10^{-7} \text{ m} = 0.55 \mu\text{m}$$

Thus, pure ZnTe is transparent to visible light having wavelengths between 0.55 and 0.7  $\mu\text{m}$ .

21.18 The magnitude of the absorption coefficient ( $\beta$  in Equation 21.18) depends on the radiation wavelength for intrinsic insulators and semiconducting materials. This is because, for photons having energies less than the band-gap energy (or in terms of wavelength, when  $\lambda > \frac{hc}{E_g}$ ), photon absorption due to valence-band-to-conduction-band electron transitions are not possible, and, therefore, the value of  $\beta$  will be relatively small. On the other hand, when photons having energies equal to or greater than the band gap energy (i.e., when  $\lambda \leq \frac{hc}{E_g}$ ) these electron transitions by the absorption of photons will occur with the result that the magnitude of  $\beta$  will be relatively large.

In addition, there may be impurity levels that lie within the band gap (Section 21.7) from which or to which electron excitations may occur with the absorption of light radiation at specific wavelengths.

21.19 In this problem we are asked to calculate the fraction of nonreflected light transmitted through a 20 mm thickness of transparent material, given that the fraction transmitted through a 10 mm width is 0.90. From the fraction of nonreflected light transmitted,  $I'_T/I'_O$ , and using a rearranged form of Equation (21.18), we may determine the value of  $\beta$  as

$$\begin{aligned}\beta &= -\frac{1}{x} \ln \left( \frac{I'_T}{I'_O} \right) \\ &= -\left( \frac{1}{10 \text{ mm}} \right) \ln (0.90) = 1.05 \times 10^{-2} \text{ mm}^{-1}\end{aligned}$$

Now, solving for  $\frac{I'_T}{I'_O}$  when  $x = 20$  mm gives

$$\begin{aligned}\frac{I'_T}{I'_O} &= \exp(-\beta x) \\ &= \exp \left[ -\left( 1.05 \times 10^{-2} \text{ mm}^{-1} \right) (20 \text{ mm}) \right] = 0.81\end{aligned}$$

21.20 The problem asks that we derive Equation (21.19), which is

$$I_T = I_O(1 - R)^2 e^{-\beta l}$$

If we examine Figure 21.7, at the front (or left) interface, some of the incident beam having intensity  $I_O$  is reflected. Since  $I_R = I_O R$  at this surface, then

$$I'_T = I_O - I_O R = I_O(1 - R)$$

in which  $I'_T$  is the intensity of the nonreflected beam at the front surface that is transmitted.

Now there will be absorption of this transmitted beam as it passes through the solid and transparent medium according to Equation (21.18). Just inside the back (or right) interface, the beam has passed through a thickness  $l$  of this material ( $x = l$ ) and, therefore, the intensity of the transmitted beam at this point ( $I''_T$ ) is just

$$I_T'' = I_T' e^{-\beta l} = I_0(1 - R)e^{-\beta l}$$

Finally, a second reflection will occur at the back interface as the beam passes out of the medium. The intensity of the reflected beam ( $I_R''$ ) is just

$$I_R'' = I_T'' R = I_0 R(1 - R)e^{-\beta l}$$

And the intensity of the final transmitted beam ( $I_T$ ) becomes

$$\begin{aligned} I_T &= I_T'' - I_R'' \\ &= I_0(1 - R)e^{-\beta l} - I_0 R(1 - R)e^{-\beta l} \\ &= I_0(1 - R)^2 e^{-\beta l} \end{aligned}$$

which is Equation (21.19).

21.21 We are asked to compute the thickness of material to yield a transmissivity of 0.75 given that  $T$  is 0.85 when  $l = 20$  mm,  $n = 1.6$ , and for normally incident radiation. The first requirement is that we calculate the value of  $\beta$  for this material using Equation (21.19); however, this necessitates that we first compute the value of  $R$  using Equation (21.13) as

$$\begin{aligned} R &= \frac{[n_s - 1]^2}{[n_s + 1]^2} \\ &= \frac{(1.6 - 1)^2}{(1.6 + 1)^2} = 5.33 \times 10^{-2} \end{aligned}$$

And, from a rearranged form of Equation (21.19), we get

$$\beta = -\frac{1}{l} \ln \left[ \frac{I_T}{I_0(1 - R)^2} \right]$$

$$= -\frac{1}{l} \ln \left[ \frac{T}{(1-R)^2} \right]$$

$$= -\left( \frac{1}{20 \text{ mm}} \right) \ln \left[ \frac{0.85}{(1 - 5.33 \times 10^{-2})^2} \right] = 2.65 \times 10^{-3} \text{ mm}^{-1}$$

Now, solving for  $l$  from Equation (21.19) when  $T = 0.75$

$$l = -\frac{1}{\beta} \ln \left[ \frac{T}{(1-R)^2} \right]$$

$$= -\frac{1}{2.65 \times 10^{-3} \text{ mm}^{-1}} \ln \left[ \frac{0.75}{(1 - 5.33 \times 10^{-2})^2} \right]$$

$$= 67.3 \text{ mm}$$

21.22 (a) The characteristic color of a metal is determined by the distribution of wavelengths of the nonabsorbed light radiation that is reflected.

(b) The characteristic color of a transparent nonmetal is determined by the distribution of wavelengths of the nonabsorbed light radiation that is transmitted through the material.

21.23 For a transparent material that appears colorless, any absorption within its interior is the same for all visible wavelengths. On the other hand, if there is any selective absorption of visible light (usually by electron excitations), the material will appear colored, its color being dependent on the frequency distribution of the transmitted light beam.

21.24 This problem calls for a calculation of the reflectivity between two quartz grains having different orientations and different indices of refraction (1.544 and 1.553). We must employ Equation (21.12) since the beam is normal to the grain boundary. Thus,

$$R = \frac{[n_2 - n_1]^2}{[n_2 + n_1]^2}$$



$$= \frac{(1.553 - 1.544)^2}{(1.553 + 1.544)^2} = 8.45 \times 10^{-6}$$

21.25 Amorphous polymers are normally transparent because there will be no scattering of a light beam within the material. However, for semicrystalline polymers, visible light will be scattered at boundaries between amorphous and crystalline regions since they have different indices of refraction. This leads to translucency or, for extensive scattering, opacity, except for semicrystalline polymers having very small crystallites.

21.26 (a) The phenomenon of luminescence is described in Section 21.11.

(b) The feature that distinguishes fluorescence from phosphorescence is the magnitude of the time interval between photon absorption and reemission events. Fluorescence is for delay times less than a second; phosphorescence occurs for longer times.

21.27 (a) The phenomenon of photoconductivity is explained in Section 21.12.

(b) Zinc selenide, having a band gap of 2.58 eV, would be photoconductive. In order to be photoconductive, electrons must be excited from the valence band into the conduction band by the absorption of light radiation. According to Equation (21.16a), the maximum band gap energy for which there may be absorption of visible light is 3.1 eV; since the band gap energy for ZnSe is less than this value, photoinduced valence-band-to-conduction-band electron transitions will occur.

21.28 A photographic light meter is used to measure the intensity of incident light radiation. Each photon of incident light induces a valence-band-to-conduction band electron transition in which both electrons and holes are produced, as depicted in Figure 21.5(a). The magnitude of the photoinduced current resulting from these transitions is registered, which is proportional to the numbers of electrons and holes, and thus, the number of incident photons, or, equivalently, the intensity of the incident light radiation.

21.29 Section 21.13 contains a description of the operation of a ruby laser.

21.30 This problem asks for the difference in energy between metastable and ground electron states for a ruby laser. The wavelength of the radiation emitted by an electron transition from the metastable to ground state is cited as 0.6943  $\mu\text{m}$ . The difference in energy between these states,  $\Delta E$ , may be determined from using a combined form of Equations (21.6) and (21.3), as

$$\begin{aligned}\Delta E &= h\nu = \frac{hc}{\lambda} \\ &= \frac{(4.13 \times 10^{-15} \text{ eV} \cdot \text{s})(3 \times 10^8 \text{ m/s})}{6.943 \times 10^{-7} \text{ m}} \\ &= 1.78 \text{ eV}\end{aligned}$$

### Design Problems

21.D1 This problem stipulates that GaAs and GaP have room-temperature band gap energies of 1.42 and 2.25 eV, respectively, that they form solid solutions in all proportions, that alloys of these two semiconductors are used for light-emitting diodes wherein light is generated by conduction band-to-valence band electron transitions, and that the band gap of a GaAs-GaP alloy increases approximately linearly with GaP additions (in mol%). We are asked to determine the composition of an alloy that will emit red light having a wavelength of 0.68  $\mu\text{m}$ . It first becomes necessary to compute the band-gap energy corresponding to this wavelength of light using Equation (21.3) as

$$\begin{aligned}E_g &= \frac{hc}{\lambda} \\ &= \frac{(4.13 \times 10^{-15} \text{ eV} \cdot \text{s})(3 \times 10^8 \text{ m/s})}{0.68 \times 10^{-6} \text{ m}} = 1.82 \text{ eV}\end{aligned}$$

Realizing that at 0 mol% GaP,  $E_g = 1.42 \text{ eV}$ , while at 100 mol% GaP,  $E_g = 2.25 \text{ eV}$ , it is possible to set up the relationship

$$\frac{100 \text{ mol\%} - C_{\text{GaP}}}{100 \text{ mol\%} - 0 \text{ mol\%}} = \frac{2.25 \text{ eV} - 1.82 \text{ eV}}{2.25 \text{ eV} - 1.42 \text{ eV}}$$

Solving for  $C_{\text{GaP}}$ , the composition of GaP, we get  $C_{\text{GaP}} = 48.2 \text{ mol\%}$ .

21.D2 Relatively high densities of digital information may be stored on the CD-R (read only) compact disc. For example, sound (i.e., music) may be stored and subsequently reproduced virtually free of any interference. In essence, the CD-R is a laser-optical data-storage system, wherein a continuous laser beam functions as the playback element. The input signal is stored digitally (as optical read-

only memory or OROM) in the form of very small, microscopic surface pits that have been embedded into the disc during the manufacturing process. The incident laser beam is reflected from the surface of the disc, and modulation (i.e., variation of the phase) of this read or reflected beam is achieved by optical interference that results from the depth of the pits.

These read-only discs consist of a substrate into which the datum pits have been replicated. This substrate must be protected, which is accomplished by a thin and reflective layer of aluminum, on top of which is coated an ultraviolet curable lacquer. Since the substrate is the key component of the optical path, its properties are extremely important. Some of the substrate characteristics that are critical are as follows: 1) it must be highly transparent; 2) it must be possible to economically produce discs that are uniformly thick and extremely flat; 3) water absorption must be low so as to avoid distortion; 4) high mechanical stability, good impact resistance, and high heat distortion resistance; 5) good flow properties (while in a molten state) so as to avoid the establishment of thermal stresses and subsequent optical nonuniformities (i.e., nonuniform birefringence); 6) the material must be clean and defect-free in order to ensure error-free scanning; and 7) it must have a long lifetime (on the order of 10 years).

The current material-of-choice for audio CD-Rs is a relatively low molecular weight polycarbonate since it is the most economical material that best satisfies the above requirements.

## CHAPTER 22

### **ECONOMIC, ENVIRONMENTAL, AND SOCIETAL ISSUES IN MATERIALS SCIENCE AND ENGINEERING**

#### PROBLEM SOLUTION

22.D1W The three materials that are used for beverage containers are glass, aluminum, and the polymer polyethylene terephthalate (designated as PET or sometimes PETE). Currently, the most commonly used of these three materials is the PET. Its optical clarity is excellent, it is significantly lighter than glass, PET has high burst and impact strengths and is shatter-proof, it is inexpensive to produce, has high gas permeation resistance, is easily fabricated (by blow-molding), and PET containers are safer (there is no breakage as with glass and no cuts result from pull-tabs as with the Al cans). There are virtually no incineration and landfill problems with PET, although, PET is relatively nondegradable. On the down side, PET containers are nonrefillable, but even so, they require less energy to produce per filled unit volume than either aluminum or glass. Also, they can be recycled.

Glass containers are refillable and recyclable, are very impermeable to the passage of gases and liquids, and are more expensive to produce and fabricate into bottles than is PET. However, glass bottles are nonbiodegradable and can be dangerous when they break.

Aluminum beverage containers are nonrefillable and nonbiodegradable, but recyclable, and are also light in weight. Again, they are more expensive to produce than are PET bottles.